

Contents

- !** **Important** This indicates important information that must always be observed when using the camera.
- 📄** **Note** These provide supplementary explanations or references to further information on the same topic.
- In this manual, the digital camera is referred to simply as "the camera". Also, SD memory cards and MultiMedia cards are referred to generically as "memory cards".

Introduction	EN-6
FCC Compliance Statement for American Users	EN-6
Handling Precautions	EN-7
Caution and Warning Symbols.....	EN-7
A World of Possibilities	EN-14
System Map.....	EN-16
Nomenclature	EN-17
Names of the Menus and Icons Shown on the Screen	EN-21
"📷" Still image, "🎬" Movie mode display.....	EN-21
"📺" Playback mode display.....	EN-23
LED Displays	EN-25
Self-timer LED (red).....	EN-25
Card access LED (orange).....	EN-25
Caution LED (red).....	EN-26
Getting Ready	EN-27
Inserting the Battery Pack	EN-27
Removing the Battery Pack	EN-28
Charging the Battery	EN-29
Inserting the Memory Card	EN-30
■ Write-Protect Switch *SD Memory Cards only.....	EN-31
Removing the Memory Card	EN-32
Turning the Camera On	EN-33
■ Viewing the battery level and charging guide.....	EN-33
Setting the Date and Time	EN-34
■ Date display format.....	EN-34
Using the Accessories	EN-36
Using the USB Cradle.....	EN-36
Attaching the Strap.....	EN-37
Using the Camera Case.....	EN-37
Using the Cleaning Pad.....	EN-38
Attaching the Filter Adapter.....	EN-38

 NEXT

Taking Pictures	EN-39
Taking Still Images.....	EN-40
■ Avoiding camera shake	EN-40
■ Holding the camera	EN-41
■ Pressing the shutter release button half way.....	EN-42
■ When the Memory Card is Full	EN-42
Using Continuous Shooting Mode	EN-44
Shooting Movies	EN-47
[fps] Setting the Frame Rate for Movies (frames per second).....	EN-49
Quickly Checking/Erasing Your Shots (Quick View)	EN-51
Checking your images.....	EN-51
Erasing images	EN-52
Selecting Scenes to Automatically Set the Focus and Flash	EN-53
Selecting the Scene Mode	EN-53
Cancelling Scene Modes	EN-55
Switching Between Macro and Landscape Mode	EN-56
■ Using Macro Mode	EN-57
[☺] Using the Self-Timer	EN-58
Using Zoom (Wide-angle and Telephoto)	EN-60
Switching the Digital Zoom ON and OFF	EN-61
Using the Flash	EN-63
Flash Modes.....	EN-63
Setting the Flash Mode	EN-64
Flash settings for each modes	EN-65
■ Effective flash range	EN-66
Adjusting the Brightness	EN-67
[☑] Using Exposure Compensation	EN-67
[ISO] Changing the ISO Sensitivity to Shoot Fast Moving Subjects	EN-69
[METERING] Selecting the Area Used for Setting the Exposure.....	EN-71
Setting the Focus	EN-73
[FOCUSING] Selecting the Focusing Method.....	EN-73
Focusing Off-Center (Focus Lock).....	EN-75
■ Subjects That Are Difficult to Focus On.....	EN-76
[AF MODE] Still and Moving Subjects.....	EN-77
[📷] Selecting the Number of Pixels	EN-78
■ Guide to Selecting the Number of Pixels	EN-79
Adjusting Image Colors and Other Settings.....	EN-80
[WB] Selecting the Light Source (White Balance).....	EN-80
Configuring white balance manually	EN-81
[CHROMA] Changing the color intensity	EN-83
[SHARPNESS] Enhancing the Image Outlines.....	EN-84



Playback	EN-85
Viewing Still Images	EN-86
Viewing Your Images Enlarged.....	EN-87
Viewing Image Information (File No/INFORMATION).....	EN-88
[🖼️] Viewing Multiple Images	EN-90
Displaying multiple images.....	EN-90
■ Using the MULTI playback / GROUP playback screen	EN-92
To return to normal playback (SINGLE playback).....	EN-93
Viewing Continuous Shooting Images	EN-94
Viewing Movies	EN-96
[▶️] Viewing Images Automatically as a Slideshow (Auto Play)	EN-98
[AUTO PLAY] settings.....	EN-98
Starting and Ending an [AUTO PLAY] Slideshow	EN-101
[🗑️]/[🗑️] Erasing Unwanted Images	EN-103
Erasing individual images (ERASE).....	EN-103
Erasing a selection of images (SELECT AND ERASE).....	EN-104
Erasing all the images (ERASE ALL).....	EN-106
[🔒] Protecting Images from Accidental Erasing (PROTECT)	EN-107
Protecting an image	EN-107
Unprotecting an image.....	EN-108
■ Tips for Erasing Images Using [PROTECT] and [ERASE ALL].....	EN-109
[🎤] Adding Sounds to Still Images (POSTRECORDING)	EN-110
Recording a message	EN-110
Playing back a recorded message.....	EN-112
Erasing a recorded message	EN-113
[📐] Resizing and Trimming Images (RESIZE)	EN-114
Resizing an image.....	EN-115
Checking and erasing resized images	EN-117
Resizing all the images	EN-118
Erasing all resized images	EN-120
[🔄] Rotating an Image	EN-121
[🖨️] Using DPOF to specify print settings	EN-123
Specifying DPOF settings	EN-123
Specifying index print settings.....	EN-125
Resetting all the DPOF print settings	EN-126
[🖨️] Printing by Connecting the Camera Directly to a Printer (PictBridge)	EN-128
Connecting the camera to the printer.....	EN-128
Specifying the print settings	EN-130
Printing individual images	EN-132
Printing multiple images.....	EN-133
Printing using DPOF settings	EN-134
Ending PictBridge.....	EN-135



Connecting to a Windows PC	EN-136
Computer hardware and software requirements.....	EN-136
Install the USB driver (Windows 98, Windows 98SE Only).....	EN-137
Viewing images on a Windows PC	EN-139
■ Memory card folder structure.....	EN-141
Disconnecting the USB cable from a Windows PC.....	EN-142
Deleting the Device (Windows 98 and Windows 98SE only).....	EN-144
Connecting to a Macintosh	EN-146
Computer hardware and software requirements.....	EN-146
Viewing images on a Macintosh.....	EN-147
■ Memory card folder structure.....	EN-149
Disconnecting the USB cable from a Macintosh	EN-150
Connecting to a Television	EN-151
«Use the VIDEO OUT port to connect to the television»	EN-151
«Playback on a television that supports D3 or higher video input».....	EN-153
Displaying Information (File No Display).....	EN-154
[] Rotating an Image	EN-155
[] Viewing Images Automatically as a Slideshow (Auto Play).....	EN-156
[] Protecting Images from Accidental Erasing (PROTECT).....	EN-159
[] Erasing individual images (ERASE)	EN-161
Set Up	EN-162
[FORMAT] Initializing a Memory Card.....	EN-163
[BRIGHT CNTRL] Adjusting the LCD Monitor Brightness	EN-164
[INSERT DATE] Adding the Date to Images	EN-165
[POWER SAVE] Having the Camera Turn Off Automatically to Save Power.....	EN-166
■ Notes on using the power save function (in "  " or "  " mode)	EN-168
[BEEP] Adjusting the Volume of the Camera Button Beep.....	EN-169
[SHUTTER VOL] Adjusting the Volume of the Shutter Sound.....	EN-170
[START SCREEN] Selecting the Startup Screen.....	EN-171
To set the CONTAX logo screen (SINGLE/MULTI)	EN-171
To set a user-defined screen (SINGLE).....	EN-172
To set a user-defined screen (MULTI)	EN-174
Turning the startup screen off.....	EN-176
[REC REVIEW] Checking Images Right After You Shoot Them	EN-177
[言語 LANGUAGE] Selecting the Menu Language.....	EN-178
[VIDEO OUT] Setting the Output Format for a TV Connection	EN-179
[STARTUP MODE] Setting the Mode the Camera Starts In	EN-180
[DISPLAY INFO] Choosing the Information Displayed on the Screen	EN-181
[FILE NO.] Starting Image File Numbers from 0001	EN-182
[MODE RESET] Resetting Function Settings	EN-184
List of Menu Items and Default Values	EN-185



Troubleshooting **EN-187**

 Problems and Solutions EN-187

 Messages and Responses EN-190

Basic Digital Camera Glossary **EN-192**

Index **EN-196**



FCC Compliance Statement for American Users

DIGITAL STILL CAMERA CONTAX U4R



Tested To Comply With FCC Standards

FOR HOME OR OFFICE USE

FCC Statement

This device complies with Part 15 of the FCC Rules. Operation is subject to the following two conditions:

(1) This device may not cause harmful interference, and (2) this device must accept any interference received, including interference that may cause undesired operation.

NOTE

This equipment has been tested and found to comply with the limits for a Class B digital device, pursuant to Part 15 of the FCC Rules. These limits are designed to provide reasonable protection against harmful interference in a residential installation. This equipment generates, uses and can radiate radio frequency energy and, if not installed and used in accordance with the instructions, may cause harmful interference to radio communications. However, there is no guarantee that interference will not occur in a particular installation. If this equipment does cause harmful interference to radio or television reception, which can be determined by turning the equipment off and on, the user is encouraged to try to correct the interference by one or more of the following measures:

- Change the direction of the radio or TV antenna. Move the equipment or the radio or TV. For example, if the equipment is to the right of the TV, move it to the left of the TV. Or, move the equipment farther away from the radio or TV.
- Plug the equipment into a different outlet. Do not plug your radio or TV into the same circuit as your equipment.
- Ensure that all expansion slots (on the back or side of the equipment) are covered. Also, ensure that all metal retaining brackets are tightly attached to the equipment.
- If these suggestions do not help, consult your equipment dealer or experienced radio/TV technician for help.

CAUTION

If you modify the camera in any way, without getting approval from KYOCERA CORPORATION, your camera may violate FCC regulations. Violation of FCC regulations may cause the FCC to void your right to use the modified camera.

Shielded cables must be used for this equipment to comply with the relevant FCC regulation.

For customers in Canada CAUTION

This Class B digital apparatus complies with Canadian ICES-003.

Cet appareil numérique de la classe B est conforme à la norme NMB-003 du Canada.



A blue arrow pointing to the right with the word 'NEXT' written in white capital letters inside it.

NEXT

Handling Precautions

Caution and Warning Symbols

This Instruction Manual features the following caution and warning symbols to ensure that you use the camera safely. Read the contents of these warnings carefully and use the corresponding features correctly.

 DANGER	This symbol indicates procedures which have a high likelihood of resulting in death or serious personal injury if not followed properly.
 WARNING	This symbol indicates handling procedures which may result in death or personal injury if not followed properly.
 CAUTION	This symbol indicates procedures which may result in injury to the user, or physical damage to the product if not followed properly.

<Precautions for Operating the Camera>

 WARNING	<ul style="list-style-type: none"> • If camera or batteries become hot, emit smoke or a burning smell, or display other abnormal symptoms, remove them from the camera immediately to prevent fire. When handling the batteries, take precautions to avoid being burned. • Never attempt to disassemble or modify the camera, since you may receive a severe electric shock. • Do not operate the electronic flash at close proximity to a person's eyes (especially those of an infant), since eye damage may result. • Do not attempt to take pictures while driving or walking since you may cause an accident. • When taking pictures, remain aware of your surroundings and what is happening around you.
---	---



⚠ CAUTION

- Clean the camera well after using it at the beach or other locations subject to large concentrations of sand or dust. Salt air may promote corrosion of metal components and damage or short circuits in electronic parts, causing the camera to emit smoke or catch fire. Sand inside the camera may result in internal damage and operating malfunctions.
- If the camera is brought quickly from a cold place to a warm room, condensation may form on the lens and internal parts. Such condensation may result in damage or short circuits in electronic parts, causing the camera to emit smoke or catch fire. Whenever possible, avoid subjecting the camera to sudden changes in temperature.
- This camera is a precision electronic instrument, and should be protected from impacts and falls that might cause damage to internal parts or the shorting of circuitry.
- This camera is an electronic device which uses a high-performance IC. The heat emitted from the IC may make the camera hot during use. It is not a failure.
- **When taking the camera overseas or using it to record important events, check its operating condition and take test pictures beforehand to confirm proper operation.**

- This camera is not designed to be waterproof, and cannot be used in the rain or under water. If the camera should inadvertently be exposed to water, it should be taken quickly to a Contax Service Center for inspection.
- Take great care to keep the photography lens and other parts clean since soiling such as fingerprints can affect the accuracy of the camera's metering and focusing functions. If these areas become soiled and require cleaning, wipe them gently with the supplied cleaner or a third-party lens cleaning cloth. Any dust or debris should be removed using a blower or lens brush.
- Clean the camera body by wiping with soft cloth. Never use benzene, thinner, or other volatile solvents or cleansers, since such substances will damage the body materials.
- Do not remove the SD memory card or Multi-Media Card (MMC) while the card access LED is flashing.
- Interference may occur in recorded or played back images when the camera is used in areas subject to strong electromagnetic interference (e.g., near a television set or stereo speakers).
- Do not direct the camera lens directly toward the sun when shooting, since the CCD element may be damaged.
- If the camera is dropped, it may be damaged internally or parts may have been dislodged even when there is no visible external damage. The camera must be taken to a Contax Service Center for checking.
- Do not attempt to touch the insides of the memory card slot, since damage or malfunction may result.



<About the Camera Plate / Camera Case (Leather)>

- Rain and other forms of moisture are harmful to leather. Do not store the camera in humid locations or where mold is likely to form.
- Do not store the camera in locations exposed to high temperature or heat sources.
- Do not apply volatile substances such as benzene or thinners to the camera.
- Do not wipe the camera with water.
- If the camera gets wet, remove any moisture by pressing lightly with a soft dry cloth and then place the camera in a well ventilated location so that it is exposed to moving air.
- Water drops and sweat can cause staining.
- The higher the leather quality, the greater the likelihood of color seepage. Take care that color does not run onto your clothes, etc.
- When using a lens cleaner, keep the cleaner away from the leather.

<Accessories>

For best performance, we recommend the use of genuine Contax accessories. Contax is not responsible for any accidents or damage caused by the use of accessories made by other manufacturers or fashioned by the user.

<Microcomputer Protection Circuit>

This camera incorporates a safety circuit to protect its microcomputer against strong external static electricity. Though rare, it may fail to function because this safety circuit has come into action. In this case, turn off the camera's power, remove the batteries, reload them and use the camera again.

<Storing the Camera>

CAUTION

- Store the camera in a well-ventilated location, avoiding damp or dusty areas, drawers or boxes containing mothballs, or in laboratories or other locations where chemicals are handled. Exposure to such chemical fumes can result in damage to the camera's circuitry, resulting in short circuits and causing the camera to emit smoke or catch fire.

- Do not place the camera in places that may be exposed to high temperatures for extended periods of time (the beach in summer, a closed car under bright sun, etc.). Such high temperatures may cause adverse affects or damage to the camera, batteries, or memory cards.
- Remove the battery pack before storing the camera for extended periods of time, to prevent battery leakage and resulting damage.

<LCD Monitor>**⚠ CAUTION**

- Rubbing or pressing strongly on the LCD monitor screen can result in damage or malfunctions. If there is dust or dirt on the LCD monitor, blow it off with a blower brush. Heavy soiling should be wiped off using soft cloth.
- If the LCD monitor should become broken, take precautions to prevent personal injury from glass fragments.
- If the LCD monitor breaks and its liquid contacts your skin, quickly wipe away any remaining liquid and wash the skin with soap and water. If the liquid should enter the eyes, wash with clean running water for at least 15 minutes, then seek medical attention immediately.

- Due to the innate characteristics of LCD panels, a few pixels may appear permanently lighted or may not light at all. This is not a malfunction, and does not affect the recorded image in any way.
- The LCD monitor may appear difficult to see in some outdoor lighting situations.

<Precautions for Handling Rechargeable Lithium Ion Battery Pack BP-1100S>**⚠ DANGER**

- Do not recharge or place batteries near sources of high heat (near flames, heaters, or in direct sunlight, etc.), or in places exposed to flammable gasses, since the batteries may generate heat, emit smoke, or rupture.
- Do not allow the positive (+) and negative (–) terminals of batteries to be shortcircuited by metallic wires or object, since batteries may generate heat or emit smoke or flames.
- Do not store batteries together with keys, necklaces, coins or other metallic objects, since the objects may contact the battery terminals, causing short-circuits.
- Do not try to heat batteries, or dispose of them in fire, since they may generate heat, emit smoke or flame, or rupture.
- Do not attempt to disassemble or modify batteries, since they may generate heat, emit smoke or flame, or the internal battery liquid may enter your eyes, causing blindness or other personal injury. If battery liquid should enter the eyes, wash the eyes with clear running water and seek medical attention immediately.
- This battery pack has been designed for exclusive use with this camera. Always use the camera to recharge the battery pack. Do not use the battery pack in any device other than this camera and do not attempt to recharge it using a third-party charger as the battery pack may generate heat or smoke, catch fire or explode.



⚠ WARNING

- Never place batteries in a microwave oven or other container exposed to high-voltage, since battery liquid may leak, or the battery pack may generate heat, emit smoke or flame, or rupture.
- Do not use leaking batteries. Battery liquid may contact your skin, causing personal injury. In the event battery liquid does contact skin, wash immediately with clean water.
- Do not use broken or ruptured batteries, since they may generate heat, emit smoke or flame, or cause electrical shock.

⚠ CAUTION

- Do not place batteries in water of any kind, or allow them to become wet, since the batteries may generate heat, emit smoke or flame, or cause electrical shock.
- Do not use or attempt to recharge wet batteries, since they may generate heat, emit smoke or flame, or cause electrical shock.
- Do not store batteries in locations accessible to small children, since injury could result.
- Do not throw batteries or subject them to strong impacts, since they may be damaged and leak battery fluid.
- Whenever possible, use batteries at room temperature ($20^{\circ}\text{C} \pm 5^{\circ}\text{C}$). The battery capacity and usable time between recharging may be reduced in situations of extreme heat or cold, such as during mid-summer or deep winter weather, or when batteries are left in a hot location (e.g., inside a closed car exposed to sun). Such conditions may also shorten the usable service life of the battery.
- When not using batteries, store them in a cool, dry location.

**Lithium-Ion Battery Pack.**

Please recycle after its service life has finished.



<Precautions for Using the AC Adapter>

WARNING

- Be sure that AC adapter plugs are connected securely before use. Loose plugs and poor contacts can cause generation of heat, fire, and electrical shock.
- Do not attempt to modify the AC adapter's cords, or subject them to unreasonable force. Damage to the cords can cause fires and electrical shock. If cords become so damaged that their wire cores are exposed, discontinue use and consult your dealer or Contax Service Center.
- Do not attempt to remove covers, disassemble, repair or modify AC adapter, since dangerous electrical shock could result.
- AC adapter plugs that have become laden with dirt or household dust should not be used or approached with metal objects, since electricity might be transmitted through the metal, causing fire or personal electrical shock. In the event of heavy soiling of a plug, remove it from its outlet and clean away the dirt before reusing.
- In the event that AC adapter plug emits smoke or unusual smell or sound, or if it is damaged by impact or falling, cease use immediately. Continuing to use a damaged plug could result in fire danger. In the event of damage to a plug, consult your dealer or Contax Service Center.
- Do not connect the AC adapter to any sources of power other than a household AC outlet (AC 100V to 240V; 50/60Hz). Using the adapter with other voltages or ratings may cause the hazard of fire or electrical shock.

CAUTION

- Use only the dedicated AC adapter supplied with the digital camera. Using other adapters may result in accidents and fire danger.
- Never attempt to splice the AC adapter cord, or subject it to severe twisting, bending, or stretching. This may cause breakage or other damage to the wires, resulting in a risk of fire or electrical shock. Plugging the cord into a low capacity power outlet, etc. may cause a fire.
- Do not connect or disconnect the AC adapter with wet hands, since personal electrical shock could result.
- Always grasp the plug body (not cord) when removing the AC adapter plugs from camera and power outlet. Pulling on the cords could cause breakage or other damage to the wires, resulting in danger of fire or electrical shock.
- The AC adapter has been designed for exclusive use with this camera. To prevent the danger of fire and electrical shock, do not use the adapter with products other than the specific digital camera for which it was designed.
- If you notice any damage to the AC adapter, including broken wires or faulty plug connections, stop using the AC adapter and consult your dealer or Contax Service Center as soon as possible.

- Prolonged use may cause the AC adapter to feel warm; this is a normal phenomenon and not a malfunction.
- When not using the AC adapter for an extended period of time, first remove the plug from the USB cradle, then disconnect the adapter from the AC outlet.
- If you wish to use the AC adapter while batteries are loaded in the camera, first set the camera's power switch to OFF, then connect the AC adapter before turning on the camera again.

 **BACK** **NEXT** 

Test Photos and Warranties

Make it a practice to take test shots before beginning any photography session to confirm that images are being recorded properly. Contax will not be held responsible for failure of photographs to be recorded or transmitted to a computer due to defects in the recording media (SD memory card or MultiMedia Card (MMC)).

Copyright Information

Photographs taken of professional performances, exhibitions, displays, or copyrighted materials may be used only for your own personal enjoyment, and only with the consent of the copyright holders. Other use may constitute violation of applicable copyright laws. Be aware that some performances, exhibitions, or displays may impose restrictions on photographic or other recording even when the purpose of such recordings is personal enjoyment.



- The SD logo is a registered trademark.
- MultiMediaCard™ is a registered trademark of Infineon Technologies AG (Germany), licensed to MMCA (MultiMediaCard Association).
- Microsoft and Windows are registered trademarks of Microsoft Corporation in the United States and/or other countries.
- Macintosh, Mac OS, QuickTime™, and the QuickTime logo are registered trademarks of Apple Computer, Inc.
- Copyrights for PRINT Image Matching and PRINT Image Matching II are held by Seiko Epson Corporation.
- Adobe and Adobe Acrobat Reader are trademarks of Adobe Systems Incorporated.
- The DPOF trademark indicates that the product conforms to the specifications of the "Digital Print Order Format (DPOF) for digital camera print information". Copyright for DPOF Version 1.00 is held jointly by Canon Inc., Eastman Kodak Co., Fuji Photo Film Co., Ltd and Matsushita Electric Industrial Co., Ltd.
- All other corporate and brand names are the trademarks or registered trademarks of their respective owners.

PRINT Image Matching

- * This product supports PRINT Image Matching II. When used in combination, PRINT Image Matching II-enabled digital still cameras, printers and software help photographers to produce images that more faithfully reflect the actual photography conditions and the intentions of the photographer.

PictBridge

- * This camera supports PictBridge. By connecting this digital camera directly to a PictBridge-compatible printer, you can select images on the camera's LCD monitor and start print jobs from the camera.



A World of Possibilities

This digital camera, with its slimline body and rotatable lens and LCD monitor units, can be used in various ways not possible with conventional digital cameras.

● Stylish Slimline Body

The ultra-slim body of the CONTAX U4R is only 18 mm thick.

You can conveniently put the camera in your pocket and take it with you to take photos whenever you like.



● Rotating lens unit and LCD monitor

You can rotate the lens unit and LCD monitor unit to any position through 120° in either direction.

By pointing the lens unit at yourself, you can take your own picture (self portrait) while watching the image on the LCD monitor.

By changing the angle of the lens unit, you can use the camera like a periscope to take pictures over the heads of a crowd while you view the image on the LCD monitor.

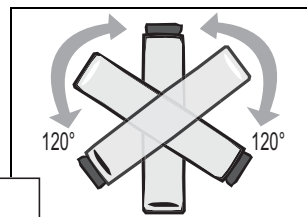
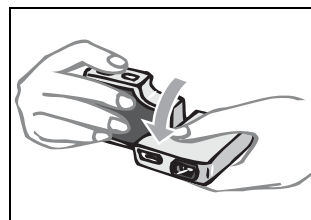

NEXT 

● Flat body makes it easy to put down

If you rotate the lens unit and LCD monitor back to their original positions, the flat camera body offers superb stability. This is really useful when you need the camera to be stable so you can take pictures using the self-timer or the macro function while you check the image by looking at the LCD monitor from above.



● D3 video output terminal lets you enjoy viewing high-resolution pictures on a television

The USB cradle is fitted with a D3 video output terminal that supports 1080 scan lines.

By connecting the camera to a television with a D3 or higher video input connector, you can view images that were taken at relatively high resolutions.

* D1 and D2 video input connectors are not supported.

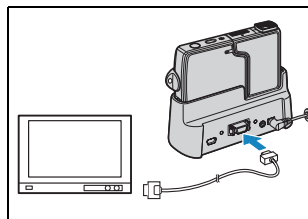

System Map

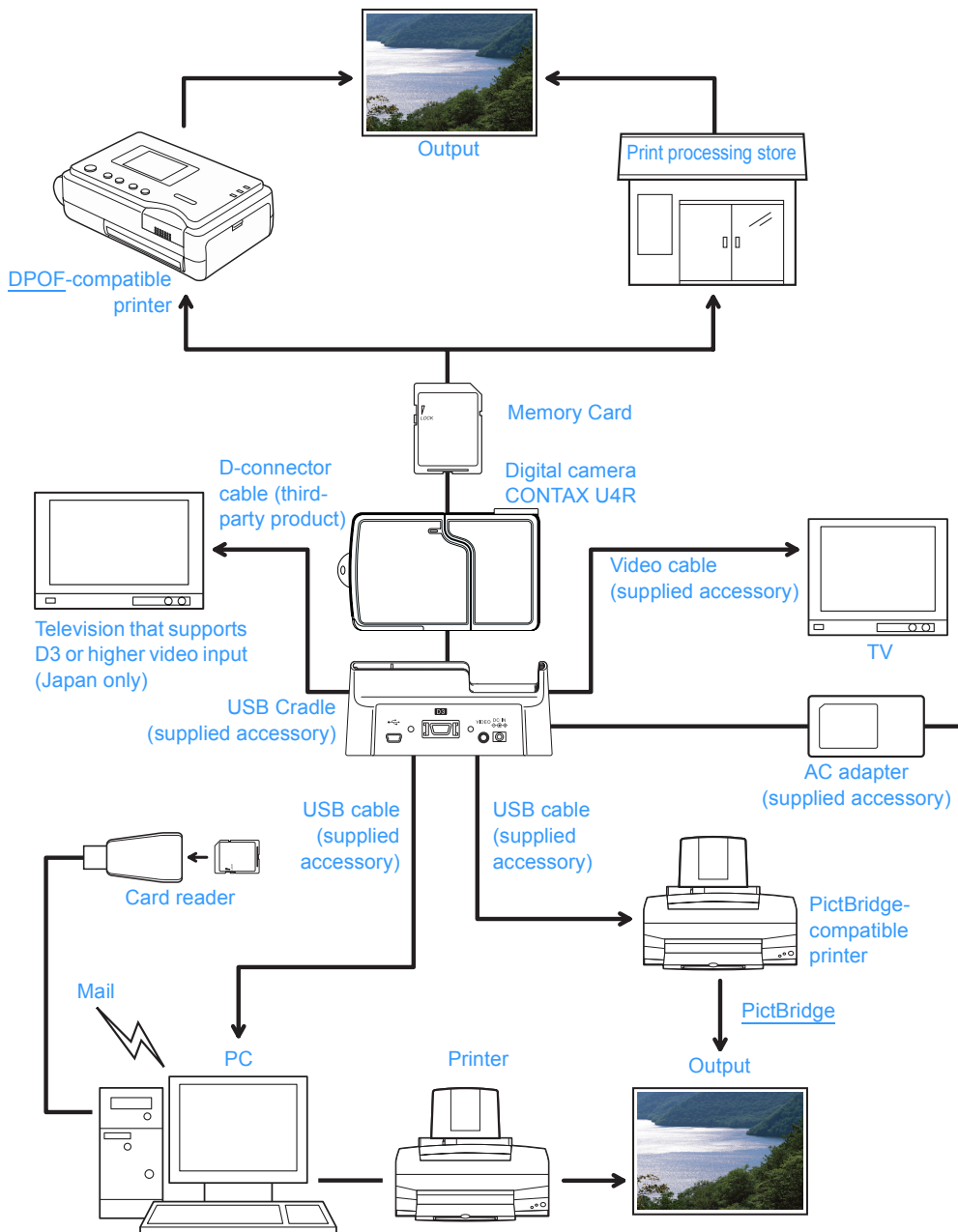

[← BACK](#)

Nomenclature

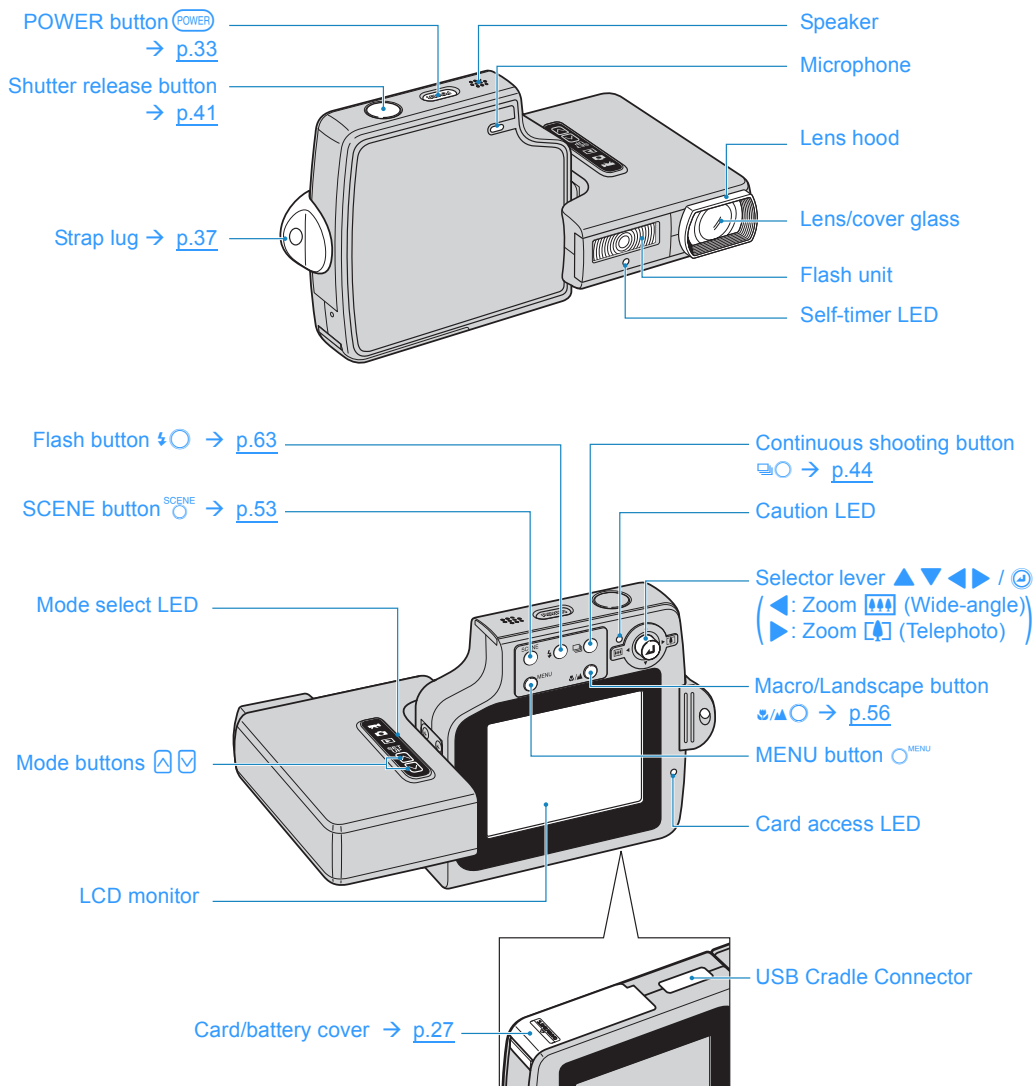

● USB Cradle

Use the USB cradle to charge the battery pack and to connect to a computer, printer, television or television that supports D3 or higher video input (Japan only).

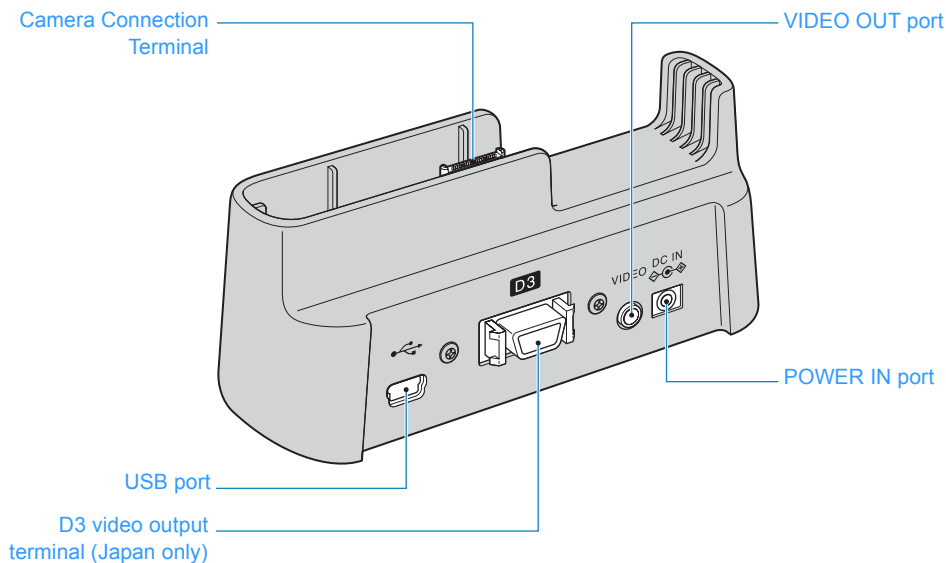

● Camera Functions

You can access a wide variety of camera functions by pressing the mode buttons to change the camera mode. The buttons on the LCD monitor unit offer a range of settings to suit photography in a variety of situations.

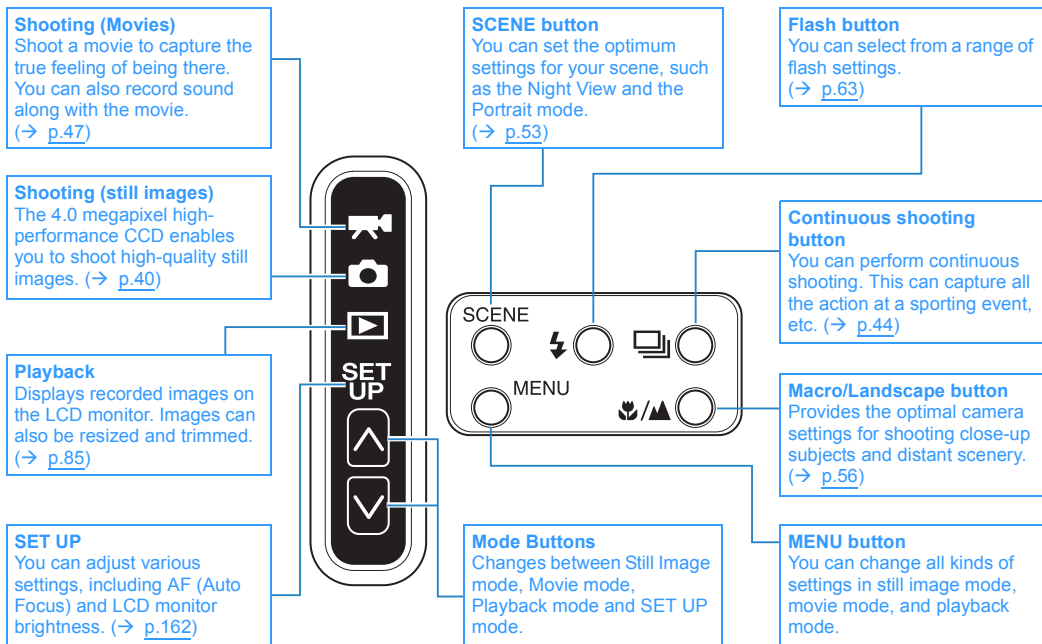

Digital cameras also offer the user a range of other options, including connecting to a computer and getting your images printed at a print processing store.

Connecting to a computer

Connecting your camera to a computer using the dedicated USB cradle and USB cable gives you access to a wide range of uses for your images, including using image retouching software to edit your images on a computer and sending them as attachments via e-mail.

* Windows 98 and Windows 98SE users must install the USB driver from the CD-ROM provided with the camera. (→ [p.137](#))



Digital printing

You can either print out your images directly on a printer or download them onto a memory card and take them to your local print processing store for printing.

* Consult your local print processing store for details of the print services offered.

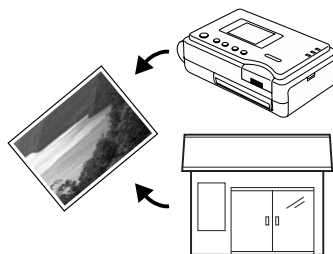

Names of the Menu and Icons Shown on the Screen

"📷" Still image, "🎬" Movie mode display

● Display in the normal screen

📷 Still image mode

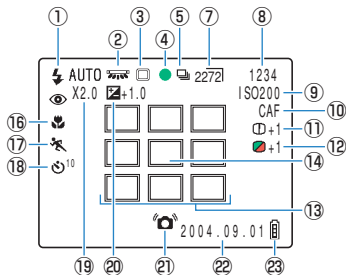

① Flash mode → [p.63](#)

② White Balance → [p.80](#)

③ Metering mode → [p.71](#)

④ Shooting mark

⑤ Continuous shooting mode → [p.44](#)

⑥ Movie mode → [p.47](#)

⑦ Number of pixels → [p.78](#)

⑧ Number of available shots

⑨ ISO sensitivity → [p.69](#)

⑩ AF mode → [p.77](#)

⑪ Sharpness → [p.84](#)

⑫ Chroma → [p.83](#)

🎬 Movie mode

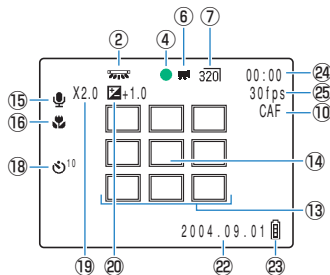

⑬ Focus frame (MULTI AF) → [p.73](#)

⑭ Focus frame (SPOT AF) → [p.73](#)

⑮ Audio mark

⑯ Macro/Landscape mode → [p.56](#)

⑰ Scene mode → [p.53](#)

⑱ Self-Timer → [p.58](#)

⑲ Digital zoom → [p.60](#)

⑳ Exposure compensation → [p.67](#)

㉑ Camera shake warning

㉒ Date

㉓ Battery level indicator

㉔ Before shooting: Available shooting time/

During shooting: Time shot

㉕ Frame rate → [p.49](#)

NEXT →

● Display when the MENU button is pressed

Still image mode

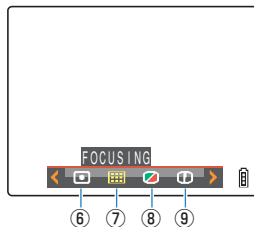
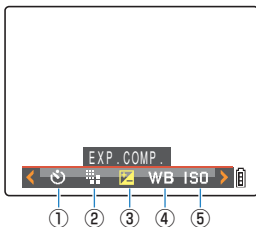

Movie mode

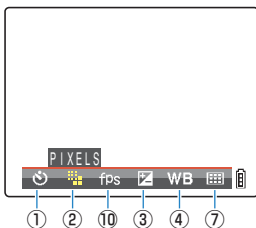

① SELF TIMER → [p.58](#)

② PIXELS → [p.78](#)

③ EXP.COMP.

④ WHITE BALANCE → [p.80](#)

⑤ ISO

⑥ METERING

⑦ FOCUSING

⑧ CHROMA

⑨ SHARPNESS

⑩ FRAME/SEC → [p.49](#)



"▶" Playback mode display

- Display when the MENU button  is pressed

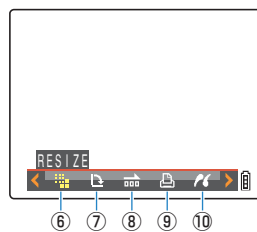
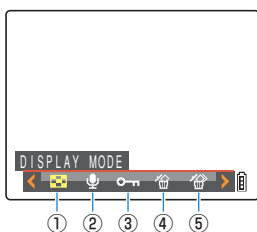

* When playing back on a television that supports D3 or higher video input.

- | | |
|--|--|
| ① DISPLAY MODE → p.90 | ⑥ RESIZE → p.114 |
| ② POSTRECORDING → p.110 | ⑦ ROTATE → p.121/p.155 |
| ③ PROTECT → p.107/p.159 | ⑧ AUTO PLAY → p.98/p.156 |
| ④ ERASE → p.103/p.161 | ⑨ DPOF → p.123 |
| ⑤ ERASE MULTIPLE → p.104 | ⑩ PictBridge → p.128 |



● Display when the selector lever is moved up ▲

File No Display

(Move the selector lever up ▲ once)

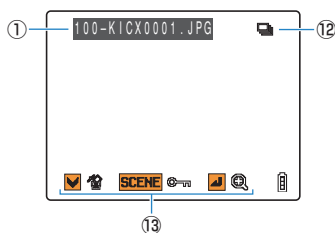

Information Display

(Move the selector lever up ▲ twice)

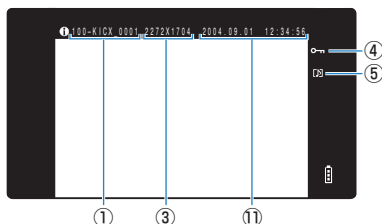
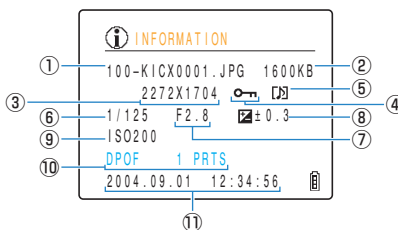

* When playing back on a television that supports D3 or higher video input.

- ① Folder numbers and file names → [p.141](#)
- ② File size
- ③ Number of pixels (image size) → [p.78](#)
- ④ Protection status
- ⑤ Whether or not voice is used
- ⑥ Shutter speed
- ⑦ Aperture

- ⑧ Exposure compensation → [p.67](#)
- ⑨ ISO sensitivity → [p.69](#)
- ⑩ DPOF settings → [p.123](#)
- ⑪ Photography date and time
- ⑫ Continuous shooting mark
- ⑬ Operating guide

*The operating guide shows a guide to which buttons can be used on a screen.



LED Displays

There are 3 LEDs on the camera. The LEDs indicate the status of the camera by either lighting or flashing.

Self-timer LED (red)

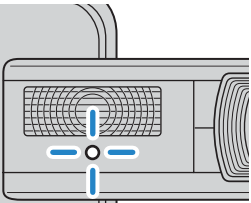
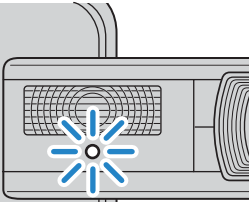

 <p>Flashes</p>	<p>While using the self-timer</p>
 <p>Lights</p>	<p>When a movie is being shot</p>
	<p>When the shutter operates and shooting has ended (does not light for continuous shots)</p>
	<p>When the camera is set to Playback mode</p>
	<p>When the camera is set to SET UP mode</p>
	<p>When the camera is connected to a PC</p>

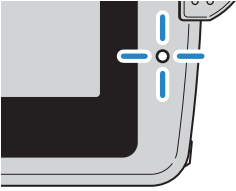
Card access LED (orange)

 <p>Flashes</p>	<p>Flashes while the camera is accessing the memory card, such as recording images to memory card or reading files. Do not open the card/battery cover or remove the memory card while the LED is flashing as this could cause data corruption or, in some cases, camera damage.</p>
---	--

NEXT 

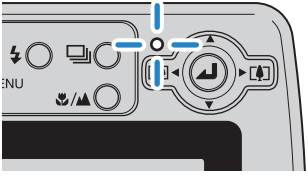
Caution LED (red)

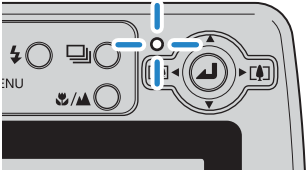
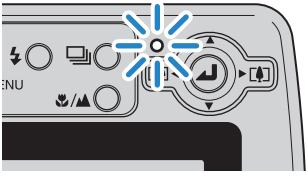
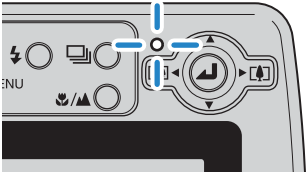
 Still image mode	 Flashes rapidly	Take particular care to avoid camera shake because a slow shutter speed is being used.
 Movie mode	 Flashes slowly	The flash is currently charging. Wait until the light stops flashing before taking your next shot.
Battery pack recharging	 Lights	Now recharging
	 Flashes	There is an error on the battery pack, AC adapter or camera.



Inserting the Battery Pack

1 Open the card/battery cover.

Slide the card/battery cover in the direction of the arrow  to open it.

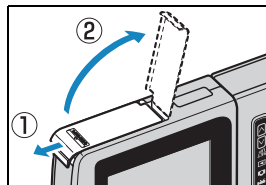

2 Insert the battery pack (BP-1100S) supplied with the camera.

Ensure that the Δ on the camera matches the \downarrow on the battery pack, as shown in the illustration, then insert the battery pack until the battery stopper is securely locked.

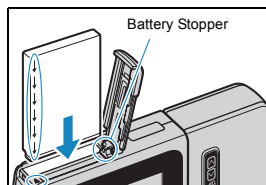

3 Close the card/battery cover.

Close the cover and slide it opposite to the direction of the arrow  to lock it.

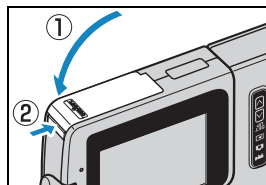

! Important

If you insert the battery pack into the camera back to front, the camera may be damaged. Make sure that the Δ on the camera and \downarrow on the battery pack match to ensure that you insert the battery pack in the correct orientation.

**NEXT**

Removing the Battery Pack

- 1 Check that the camera is turned off and then open the card/battery cover.
- 2 Slide the catch that holds the battery pack in place to the open position with the tip of your finger.
- 3 Grasp the battery pack and pull it out of the camera.

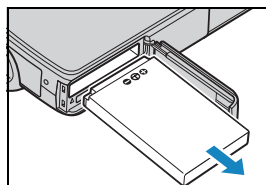
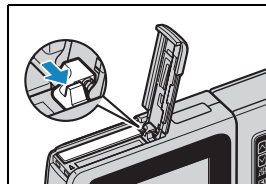

! Important

- Take care that you do not drop the battery pack. The strong impact of dropping the battery pack may cause it to leak battery fluid.
- Depending on the operating conditions of the camera, the battery pack may heat up. Be careful when removing the battery pack from the camera.

📝 Note

If you do not intend to use the battery pack for a long period of time, store it in a cool environment.



Charging the Battery

Important Ensure that the battery pack is inserted in the camera before charging.

1 Place the camera in the USB cradle.

Note Refer to "Using the USB Cradle" (→ p.36) for details on attaching the USB cradle.

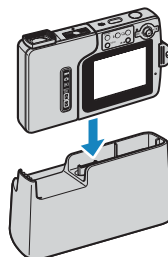

2 Plug the AC adapter into the USB cradle to charge.

Charge time is approximately 4 hours.

Turn the camera off during charging.

The caution LED (red) turns on when the camera is charging and turns off after approximately 3 hours, at which point the battery pack is 90% charged.

Leaving the AC adapter connected for approximately one hour more charges the battery pack fully.

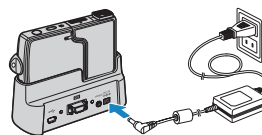

- Important**
- When you first purchase the camera, you need to charge the battery fully.
 - If the battery pack is repeatedly charged with the battery pack or camera containing the battery left in a hot location, the battery pack will deteriorate, reducing the number of photos that can be taken. When this occurs, replace the battery pack with a new one.
 - Remove the camera from the USB cradle and turn the power on to check the camera battery level. (→ p.33)

Note The AC adapter supports voltages of up to 240 V. When you are charging the camera in a foreign country, use the AC adapter cable that matches the voltage and power socket of that country. You do not need to use a voltage transformer or other devices.



Inserting the Memory Card

1 Check that the camera is turned off and then open the card/battery cover.

Slide the card/battery cover in the direction of the arrow  to open it.

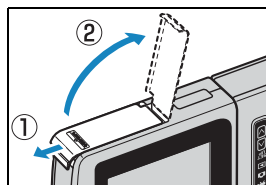

2 Insert the memory card.

Insert the memory card with the labeled side facing the LCD monitor. When inserting the card, push it into the slot until it makes a clicking sound and stops.

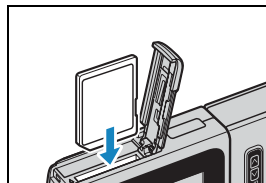

! Important

- If the card does not slide in smoothly, the card may be upside down. Check that the card is the right way up and do not try to force it into the slot.
- Do not attach stickers of any sort to the memory card as this may jam the card in the slot so that you cannot remove it.

3 Close the card/battery cover.

Close the cover and slide it opposite to the direction of the arrow  to lock it.

Note

Format the memory card in the camera before shooting to ensure the best possible performance from the camera. (→ [p.163](#))



■ Write-Protect Switch *SD Memory Cards only

SD Memory Cards come with a write-protect switch (although some cards may not have this switch).

Sliding this switch downward prevents any more files from being recorded onto the card and protects the images and files already stored on it.

If a write-protected card is inserted into the camera in "📷" or "📺" mode, "WRITE PROTECT" is displayed on the LCD monitor.

You cannot take pictures or edit images using a write-protected card. Note also that you cannot erase images stored on the card or format the card.

Write-Protect Switch
Slide this switch down to write-protect the card.

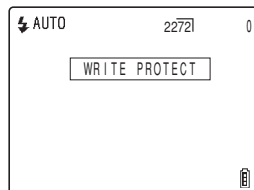
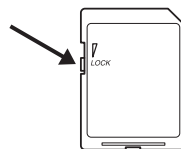

Removing the Memory Card

1 Check that the camera is turned off and then open the card/battery cover.

Slide the card/battery cover in the direction of the arrow  to open it.

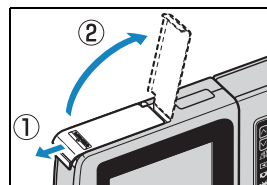

! Important When the card access LED is blinking, images are being recorded onto the memory card. Do not open the card/battery cover or remove the memory card while the LED is flashing as this could cause data corruption or, in some cases, camera damage.

2 Push the memory card in gently with your fingertip.

When the memory card is pushed in slightly, it pops back out and you can then remove it.

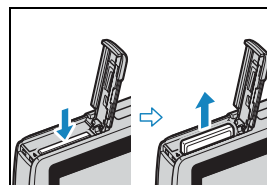

3 Close the card/battery cover.

Close the cover and slide it opposite to the direction of the arrow  to lock it.

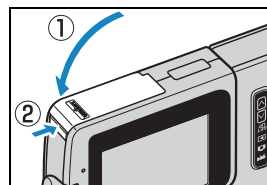

Turning the Camera On

Important Check that a memory card is inserted in the camera before turning the camera on.

1 Press the **POWER** button .

The startup screen is displayed for a few seconds and then the normal screen for the selected camera mode appears.

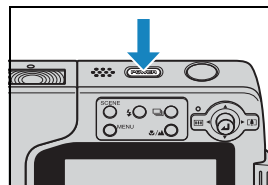

Note

- While the camera is turned on, press the POWER button  again to turn the camera off.
- You can configure whether the camera starts in still image mode when it is turned on or if it returns to same mode as when it was turned off. (→ [p.180](#))

■ Viewing the battery level and charging guide



Battery fully charged.



Approximately 70% used.



Remaining charge very low. Charge the battery soon.



Camera will not operate. Charge the battery.

When the battery charge is completely depleted, the "LOW BATTERY" message appears on the LCD monitor.

The amount of power consumed by a digital camera varies considerably depending on the environment in which it is being used. Even if the battery level indicator shows that there is still charge in the batteries, the camera may turn itself off in some camera operating conditions. Recharge the battery if this happens.

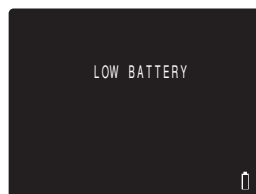

Setting the Date and Time



The first time you use your digital camera, you should set the date and time.

Your date and time settings may be cleared when you remove the battery pack or if you leave the camera unused for a long period. If this happens, reset the date and time.

- 1 Turn the camera on and press the mode button  until "SET UP" lights up on the mode select LED.

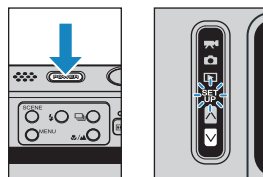
The SET UP menu screen is displayed.



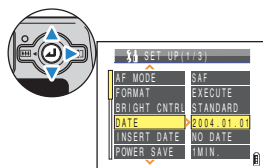

- 2 Move the selector lever up  or down  to select [DATE], then move the lever right .

The details screen for setting the date and time appears.



- 3 Move the selector lever left  or right  to select the item to set.

Moving the selector lever left  or right  changes between the date setting items in the order: Year ⇔ Month ⇔ Day ⇔ Hour ⇔ Minute ⇔ Date Display Format.

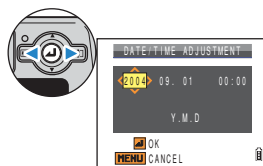

■ Date display format

This refers to the order in which the year, month and day are shown. The 3 available formats are shown on the right.

Dates are written onto prints in the date display format set here.

(→ [p.165](#))

Order	Sample Display
Y.M.D	2004. 08. 21
M.D.Y	08. 21. 2004
D.M.Y	21. 08. 2004

4 Move the selector lever up ▲ or down ▼ to change the date or select the display format.

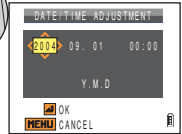

5 Press .

This completes the settings and the SET UP menu reappears.

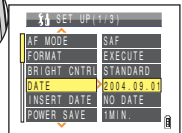

Note

On this camera, the date and time of shooting are stored on the memory card along with the image file. Setting the date and time helps you to organize your images on a personal computer.



Using the Accessories

Using the USB Cradle

Use the USB cradle to charge the battery pack and to connect to a computer, printer, television or television that supports D3 or higher video input (Japan only).

! Important Make sure the camera is turned off when attaching it to or removing it from the USB cradle.

● Placing the camera in the USB cradle.

Place the camera in the cradle in the direction shown in the illustration.

! Important Do not insert the camera the wrong way around. Inserting the camera in the wrong direction may damage the camera or cradle.

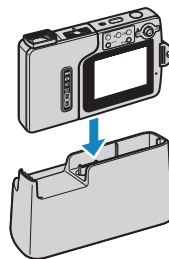

● Removing the camera from the USB cradle.

Take the camera and remove it from the USB cradle as shown in the illustration.

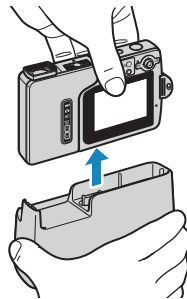

! Important Do not remove the camera from the USB cradle while the camera is communicating with a PC or other device. Doing so may corrupt the files on the memory card, or even damage the camera.

[NEXT](#) 

Attaching the Strap

Attach the supplied strap as shown in the illustration.

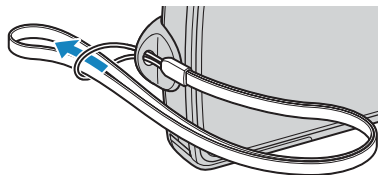

Using the Camera Case

Use the camera case as shown in the illustration.

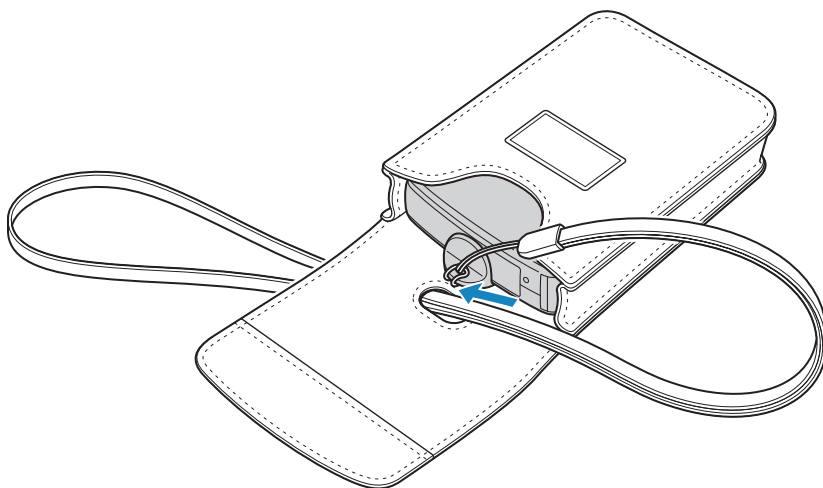

Using the Cleaning Pad

Attach the cleaning pad to the strap as shown in the illustration.

Clean the lens and LCD monitor with the side to which the cleaning cloth is attached.

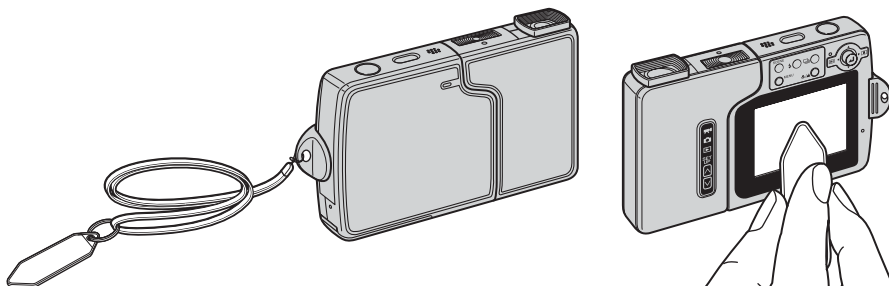

When cleaning the lens, remove the lens hood before wiping the lens with the cleaning pad.

To remove the lens hood, grip the hood with your fingertips and turn it counterclockwise.

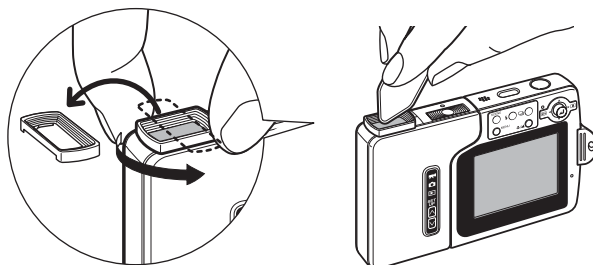

Attaching the Filter Adapter

Remove the lens hood, then attach the filter adapter by turning it clockwise.

Use commercially available 28mm diameter filters.

! Important

- The filter adapter is only for use with filters. Do not attach conversion lenses or any other component that is not a filter.
- Do not use the flash (Flash Off mode). The correct exposure cannot be obtained.
- Depending on the type of filter, exposure and focusing may be affected. Please verify before use.
- When removing the lens hood, take care not to touch the lens directly.
- Take care not to lose the lens hood.



Taking Pictures

This chapter explains how to shoot still images and movies.

▼ **Click on the section you want to read.**

Taking Still Images



Using Continuous Shooting Mode



Shooting Movies



Quickly Checking Your Shots (Quick View)



Using Scene Modes



Using Self-Timer



Using Zoom



Using Flash



Adjusting Brightness



Setting Focus



Selecting the Number of Pixels (Image Size)



Adjusting Image Colors and Other Settings



In this chapter, icons are shown below each heading as a quick guide to the modes in which the respective functions can be used.

The meanings of these icons are shown below.

Applicable Mode:

Can be used in (still image mode).

Applicable Mode:

Can be used in (movie mode).

Taking Still Images

«Applicable mode: »

You can use this camera in various ways. You can take still images, shoot a sequence of consecutive shots (continuous shooting), and shoot movies. This chapter begins by explaining how to shoot photos (still images).

- 1 Press the POWER button  to turn the camera on, then press the mode buttons   until "CAM" lights up on the mode select LED.**

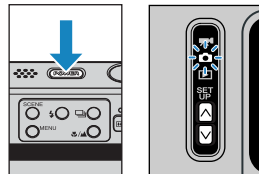

The startup screen appears and then the date is displayed for approximately 3 seconds.

Check that the date is correct.

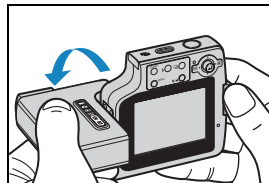

- 2 While keeping the LCD monitor facing you, gently twist the left side of the camera (the lens unit).**

Rotate the lens unit to point at the subject to be photographed while choosing an angle where the LCD monitor is easy to view.



- 3 Compose the shot by looking at the LCD monitor.**

 **Note**

Move the selector lever to the right  to zoom in on the image, and to the left  to zoom back out.
(→ [p.60](#))

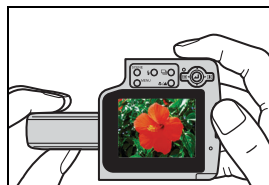

■ Avoiding camera shake

Camera shake refers to the effect of images appearing blurred or out of focus because the camera moved when the picture was taken. This is particularly likely to occur at slow shutter speeds and in macro shots.

This applies particularly to macro shots with high magnifications, where the subject's depth of field is extremely shallow, and even the slight camera movement when the shutter release button is pressed can have a large impact on the image.

In situations of this sort, place the camera on a stable surface to take the shot. Even greater stability can be achieved by using the self-timer (→ [p.58](#)) so that the camera does not move when the shutter release button is pressed.

NEXT 

■ Holding the camera

With the LCD monitor facing towards you, hold the lens unit with your left hand and the section with the LCD monitor in your right hand. Take care that your fingers do not obstruct the lens or flash. The camera is easier to hold if the lens unit and LCD monitor unit are at an angle of between 30° and 45° to each other.

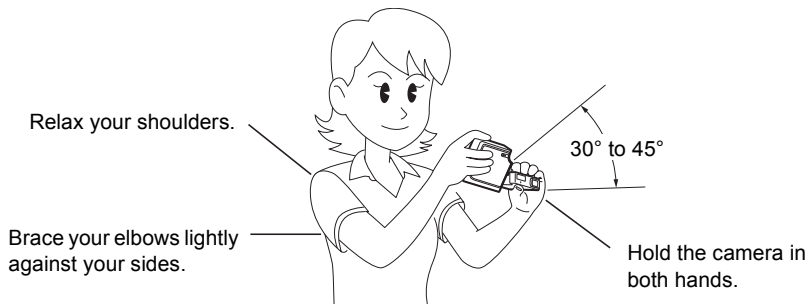

4 Press the shutter release button down half way to set the focus.

The camera gives a short double-beep, the green shooting mark "●" lights on the LCD monitor and the focus frame turns green to indicate that the focus has been set.

Note

- A flashing shooting mark "●" indicates that the focus is not set. Press the shutter release button half way again until the shooting mark "●" stays lit and the focus is set.
- When the focus frame (→ [p.73](#)) is set to [MULTI AF], the selected focus frame turns green.
- There is no focus frame displayed when the focus is fixed at infinity (Twilight mode, Night View mode, and Landscape mode).

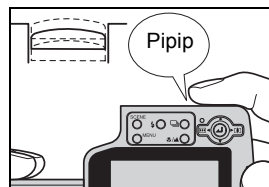

■ Pressing the shutter release button half way

When you press the shutter release button, it stops at a point on the way down to the fully pressed position. At this point, it is said to be pressed half way and the camera determines the focus in readiness for taking a picture. If you then continue pressing the shutter release button all the way down, the camera takes the picture.

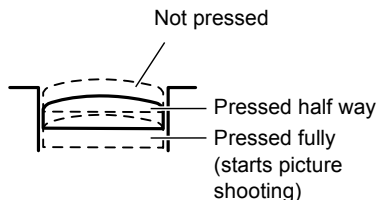

5 Press the shutter release button down fully.

The camera emits the shutter sound and takes a picture.

Note

You can adjust the volume of the shutter sound.

(→ [p.170](#))

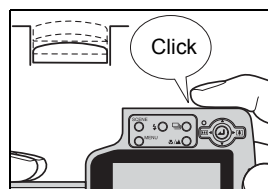

! **Important** For subjects that are closer than 60 cm to the camera, use macro mode to take the shot.
(→ [p.56](#))

■ When the Memory Card is Full

When you cannot record any more images on a memory card, the "MEMORY CARD FULL" message appears on the LCD monitor. When this happens, try the following:

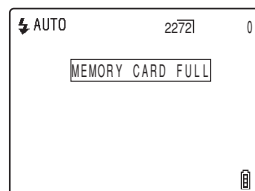

- Erase any unwanted images.
- Save your images onto a PC and then erase the images stored on the memory card.
- Insert another memory card that has some available space.



To erase images on a memory card, you can use [ERASE], [ERASE MULTIPLE] ([SELECT AND ERASE] or [ERASE ALL]) or [FORMAT]. For more information on erasing images, see [p.103](#). For more information on formatting memory cards, see [p.163](#).

To save images to a personal computer, use the USB cable provided. Refer to "[Connecting to a Windows PC](#)" (→ [p.136](#)) or "[Connecting to a Macintosh](#)" (→ [p.146](#)) for details.

! Important

- Press the shutter release button lightly with the soft pad of your fingertip. Pressing the button too hard will result in camera shake. (["Avoiding camera shake"](#) → [p.40](#))
- When the shutter speed is low, the warning LED flashes relatively fast and the camera shake warning icon [] is displayed on the screen. This indicates that there is a risk of camera shake occurring. You should place the camera on a stable surface and use the self-timer (→ [p.58](#)) or, depending on the subject, use the flash. (["Avoiding camera shake"](#) → [p.40](#), ["Using the Flash"](#) → [p.63](#))
- After taking a shot, the warning LED flashes relatively slowly and the red and white flash icon [] blinks alternately on the screen while the flash is recharging. Wait for the warning LED to go out and the flash icon to stop blinking before taking the next shot. (["Using the Flash"](#) → [p.63](#))
- When the card access LED is blinking, data is being read from or written to the card. Do not open the card/battery cover or remove the memory card while the LED is flashing as this could cause data corruption or, in some cases, camera damage. Note that you can still take pictures while the card access LED is flashing.





Using Continuous Shooting Mode

«Applicable mode: »

This camera is capable of taking a series of consecutive shots at up to approximately 3.3 frames per second.* This feature is useful for photographing moving subjects and for situations where you do not want to miss a snapshot opportunity. Select AF continuous to refocus the camera for each frame while shooting continuously.

* When using a high speed memory card (an SD Memory Card with a writing speed of 10MB/S or more).

1 Turn the camera on and press the mode buttons   until "📷" lights up on the mode select LED.

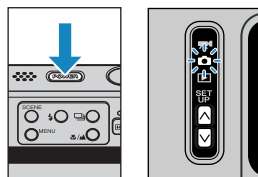

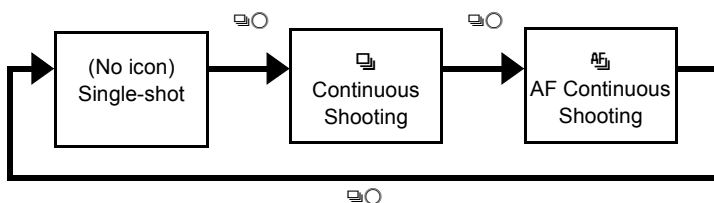
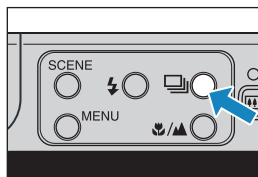

2 Press the continuous shooting button  to select continuous shooting mode.

The shooting mode changes as shown below each time the continuous shooting button  is pressed.



(No icon) (Single-Shot) : Standard shooting mode. (Default)

 (Continuous Shooting) : A series of photos can be shot continuously. (Approximately 3.3 frames per second)

 (AF Continuous Shooting) : Continuous shooting with focus set for each frame. This reduces the continuous shooting speed. (Approximately 2 frames per second)

NEXT 

3 Compose the shot.

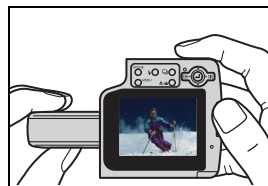

4 Press the shutter release button down half way to set the focus.

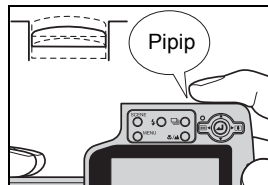

5 Press the shutter release button down fully.

The camera shoots pictures continuously for as long as you hold the button down.

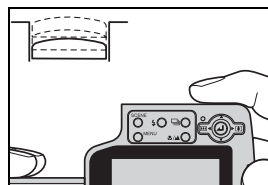

! Important

- This setting is retained when you turn the camera off.
- To ensure that you obtain true 3.3 frame per second (approx. 2 frames per second for AF continuous shooting) performance, you should format (→ p.163) the SD memory card in the camera beforehand. If you repeatedly shoot and erase frames, the continuous shooting speed may drop. If this occurs, save the images to your PC and then format the memory card using the camera before continuing.
- The number of continuous shots that can be taken varies depending on the type and capacity of the memory card in the camera and on the subject. Continuous shooting stops when the memory card is full of recorded images.
- The speed at which data is written to a memory card varies according to the type of card used.
- If you use an SD memory card that is intended for high-speed recording, you can use continuous shooting to shoot at approximately 3.3 frames per second (approx. 2 frames per second for AF continuous shooting) until the memory card is full. (The speed varies depending on the subject.)
- If slower shutter speeds are used because the subject is dark, the continuous shooting speed may be slower than 3.3 frames per second (or approx. 2 frames per second for AF continuous shooting).
- If you use the flash, the camera cannot shoot continuously.
- When you erase a single image from the middle of a group of continuous images, the group splits into 2 groups of continuous images.

A blue arrow pointing to the left, containing the word "BACK" in white capital letters.

A blue arrow pointing to the right, containing the word "NEXT" in white capital letters.

 **Note**

- When used in combination with the self-timer, a series of 3 continuous shots are taken after either 10 seconds or 2 seconds. ("[📷] Using the Self-Timer" → p.58)
- You cannot switch to AF continuous shooting in Twilight, Night View or Landscape modes.
- You cannot switch to continuous shooting or AF continuous shooting in Night Portrait mode.



Shooting Movies

«Applicable mode: »

You can use the camera to shoot movies with sound.

1 Turn the camera on and press the mode button until "🎥" lights up on the mode select LED.

The movie mark and remaining shooting time appear at the top of the screen.

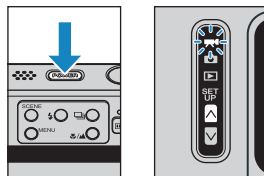

2 Compose the shot.

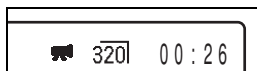
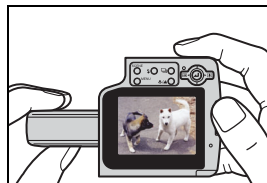

3 Press the shutter release button down half way to set the focus.

The camera gives a short double-beep, the green shooting mark "●" lights on the LCD monitor and the focus frame turns green to indicate that the focus has been set.

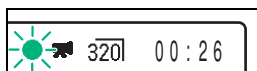
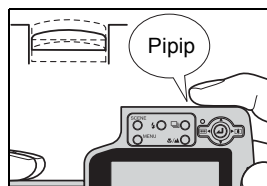

Note

- During movie shooting, the exposure is adjusted according to the ambient conditions, but the focus does not change. The entire movie is shot using the focus set just before shooting started.
- The shooting mark "●" flashes when the focus is not set. Press the shutter release button half way again until the shooting mark "●" stays lit and the focus is set.
- When the focus frame (→ [p.73](#)) is set to [MULTI AF], the selected focus frame turns green.

NEXT 

4 Press the shutter release button down fully.

The camera starts shooting the movie.

During movie shooting, the shooting mark (a red "●") appears and the self-timer LED lights. The elapsed shooting time is displayed in the upper right of the screen and the focus frame disappears.

When the remaining shooting time drops below approx. 10 seconds, the time display turns red.

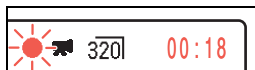
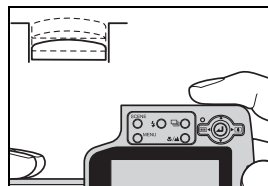

The table below shows the available shooting times for each image size using a 256 MB memory card. (Times given are for a new or freshly formatted high speed memory card at a frame rate of 30fps)

Image Size	Time
640 x 480	Approx. 1 min. 50 sec.
320 x 240	Approx. 7 min.

Available shooting time display in movie mode

- The shooting time shown on the LCD monitor when you start shooting in movie mode does not indicate the time available for one continuous shot. The length of a continuous movie shot is limited by the speed at which data is written to the SD memory card and differs depending on the card you are using.
- If you use a high-speed SD memory card (an SD memory card with a write speed of 10 MB/sec or faster), the available shooting time displayed on the LCD monitor serves as a guide to the actual continuous shooting time available.

! Important Depending on the SD memory card write speed, the camera may stop shooting mid-shot.

5 Press the shutter release button half way to stop shooting.

Note If you do not press the shutter release button half way, shooting continues until the memory card is full.



[fps] Setting the Frame Rate for Movies (frames per second)

«Applicable mode: »

The frame rate refers to the number of frames shot per second in a movie. The available frame rate settings are 30 frames per second [30fps] and 15 frames per second [15fps].

Although movement in movies with a frame rate of 30 fps is smooth, the available shooting time for 30 fps movies is shorter than for movies shot at 15 fps.

- 1 Turn the camera on and press the mode button  until "📷" lights up on the mode select LED.

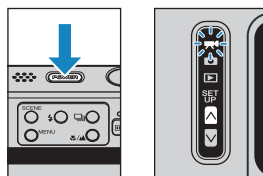

- 2 Press the MENU button  to display the menu icons.

- 3 Move the selector lever left  or right  to select FRAME/SEC [fps] and press .

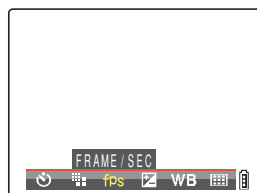

- 4 Move the selector lever up  or down  to select the desired frame rate and press .

This sets the frame rate.

[30fps]: 30 frames are shot per second. (Default)

[15fps]: 15 frames are shot per second.

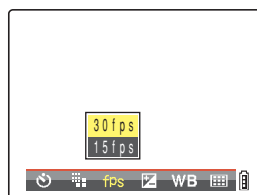

5 Press the MENU button .

The selected frame rate appears on the LCD monitor.



! Important This setting is retained when you turn the camera off.

Quickly Checking/Erasing Your Shots (Quick View)

«Applicable mode: »

This function lets you quickly check the images you have just taken and erase unwanted images when the camera is in "" or "" mode.

Checking your images

1 If the camera is ready to shoot in either "" or "" mode, press down for more than 1 second.



The last image shot appears on the LCD monitor.

Move the selector lever right to cycle forwards through the images, and left to cycle backwards through the images.

Press the shutter release button down half way to return to the normal shooting screen.

Note

- Press when an image is displayed to show the zoom magnification adjustment screen. Move the selector lever left or right to zoom in or zoom out of the image. (→ [p.87](#))
- Press the continuous shooting button when an image from a group of continuous shots is displayed to playback the group of continuous shots. (→ [p.94](#))
- You cannot play back movies or postrecorded audio. (For movies, the first frame is displayed.)
- The screen changes in the following order each time the selector lever is moved up . Refer to [p.24](#) for details of the screen displayed.

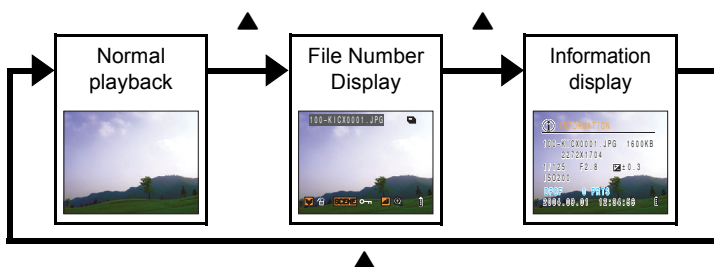

- Press the SCENE button while an image is being displayed to view the protection settings screen. Move the selector lever up to select [SET] and press to protect the currently displayed image.

NEXT

! Important Quick View cannot be used in the following situations:

- When there is no memory card inserted
- When the card/battery cover is open
- When there are no images stored on the memory card

Erasing images

1 While an image is displayed, move the selector lever down ▼.

A message appears asking you to confirm that you want to erase the image.

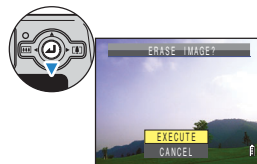

2 Move the selector lever up ▲ to select [EXECUTE], then press



The image is erased.

Press the shutter release button down half way to return to the normal shooting screen.





Selecting Scenes to Automatically Set the Focus and Flash

The camera can be set to the optimal shooting settings for any subject.

Selecting the Scene Mode

«Applicable mode: »



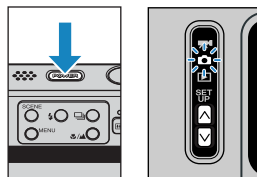

1 Turn the camera on and press the mode buttons   until "📷" lights up on the mode select LED.

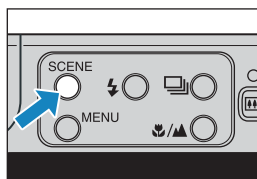

2 Press the SCENE button  .

The scene mode menu is displayed.



3 Move the selector lever up, down, left or right     to select the scene mode that suits the subject.

Refer to [p.54](#) for details on each of the scene modes.

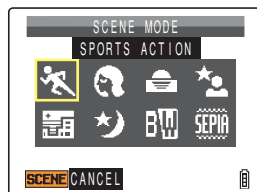

4 Press .

The scene mode is set. You can now shoot using the selected mode.

! Important

- This setting is retained when you turn the camera off.
- Each time you change the scene mode, the focus, flash and other camera settings are reset to the default settings for the new mode.

NEXT 

The following 8 scene modes are available.

Sports Action mode

This is the best scene mode for shots of moving subjects, such as at sporting events.

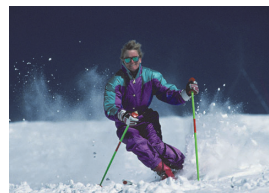

Portrait mode

This scene mode is suitable for taking pictures of people.

The white balance is optimized to give exquisite skin tones when using this scene mode.



Sunset mode

This is the best scene mode for shots of the sunset.

The flash is turned off and white balance and ISO settings are automatically configured.

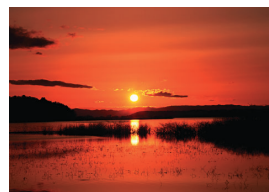

Night Portrait mode

This scene mode is ideal for shots of people against a night background.

The flash can be set either to "auto flash mode", in which the flash automatically fires according to the ambient light levels, or to "red-eye reduction auto mode", which prevents red-eye effect.



Twilight mode

This mode is optimized for shooting in the glow of twilight after the sun has set.

The flash is turned off and white balance and ISO settings are automatically configured. In addition, the focus is fixed at infinity.

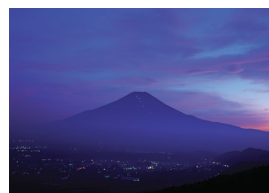

★ Night View mode

This is the best scene mode for shots of nighttime scenes.

The flash is turned off and the focus is fixed at infinity.



Black and White mode

This mode gives the same colors as photographs taken using monochrome film.



Sepia mode

This mode gives the same colors as photographs taken using sepia film.



! Important

Because slow shutter speeds are used in Sunset, Night Portrait, Twilight and Night View modes, you should place the camera on a stable surface and use the self-timer (→ [p.58](#)) when taking pictures to prevent camera shake.

Cancelling Scene Modes

«Applicable mode: »

1 Press the SCENE button  while in the scene mode configuration.



Switching Between Macro and Landscape Mode

«Applicable mode: »

Macro and Landscape modes help you select the best possible camera settings for shots of close-up subjects and distant scenery.

1 With the camera ready to shoot in "📷" or "🌿" mode, press the Macro/Landscape button .

The camera changes between Macro and Landscape mode each time the Macro/Landscape button is pressed.

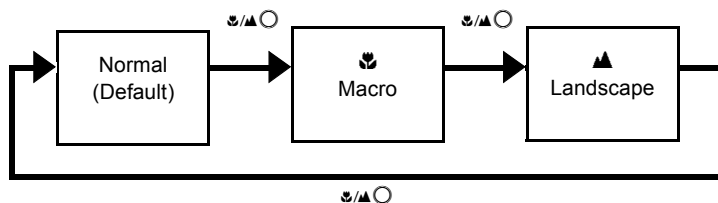
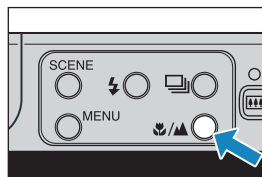

Important This setting reverts to the default value when you turn the camera off.

Note You cannot change Macro/Landscape mode while in Twilight or Night View scene modes.

Macro Mode

Macro mode allows you to take close-up pictures at distances as close as approx. 20 cm (7.9")*¹ from the subject. Because the focal length of the lens is locked in the wide-angle position (shortest focal length), the zoom does not function.*²

As flash mode, you can select either Fill-in Flash mode, in which the flash fires for every shot, or Flash Off mode, in which the flash never fires.

(→ [p.63](#))

*¹ Distance measured from the glass cover plate on the lens to the subject.

*² Only the digital zoom can be used.

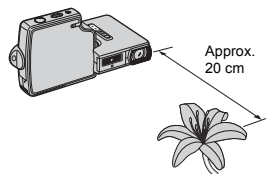
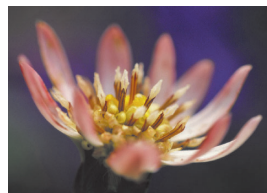

← BACK

NEXT →

■ Using Macro Mode

Compose the shot and press the shutter release button half way. The camera gives a short double-beep, the green shooting mark "●" lights on the LCD monitor and the focus frame turns green to indicate that the focus has been set.

Then, taking care not to move the camera, release the shutter to take the picture.



▲ Landscape Mode

This shooting mode is ideal for shots of scenery.









Regardless of the shooting mode, the flash is set not to fire and focus is fixed at infinity.



Using the Self-Timer

«Applicable mode:  »

The self-timer is useful for shots where you want to include the photographer in the shot, such as commemorative photographs. In this mode, the shutter releases either 2 seconds or 10 seconds after you press the shutter release button. The 2-second delay on the self-timer is also useful for preventing camera shake when you are shooting still photographs using Macro or Night View mode.

- 1 Turn the camera on and press the mode buttons   until  or  lights up on the mode select LED.
- 2 Press the MENU button  to display the menu icons.
- 3 Move the selector lever left  or right  to select SELF TIMER  and press .



- 4 Move the selector lever up  or down  to select the desired delay and press .

The self-timer is now set.

An icon appears on the LCD monitor to show the selected delay.

 : Sets the self-timer delay to 10 seconds.

 : Sets the self-timer delay to 2 seconds.

[OFF] : Normal photography. (Default)

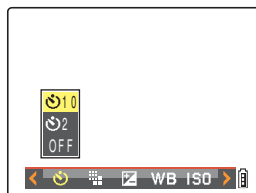

- 5 Press the MENU button .

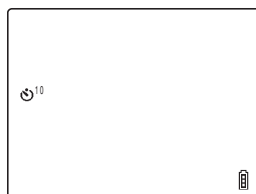

NEXT 

6 Press the shutter release button.

The self-timer runs for the selected delay time and then releases the shutter. When you are shooting a movie, movie shooting starts when the specified self-timer delay has elapsed.

! Important

- This mode is cancelled after you take the picture. To continue using the self-timer, select self-timer mode again.
- To interrupt the self-timer once it has started running, press the shutter release button half way.





Note



- Place the camera on a stable surface before taking the shot.
- In continuous shooting and AF continuous shooting modes, 3 consecutive shots are taken after the specified time has elapsed.



Using Zoom (Wide-angle and Telephoto)

«Applicable mode:  »

Use zoom to take pictures when you are at events such as sports meets or school plays where you want to zoom in on a distant subject, or when you want to compose a wide-angle shot of distant scenery.

- Selector lever right  (Telephoto) : Enlarges the image.
- Selector lever left  (Wide-Angle): Returns the zoomed image to its original size and lets you include a larger area in the shot.

As well as an optical zoom (3x) that uses the lens to change the image magnification, this camera also features a digital zoom that enlarges the image digitally. By combining the digital zoom with optical zoom, you can enlarge a still image by up to 18x or a movie by up to 6x.

! Important Using the digital zoom degrades the image quality.

1 Move the selector lever right before shooting.

A zoom bar is displayed on the bottom of the screen. The indicator in the zoom bar moves right as you zoom in and left as you zoom out.

The zoom bar remains on the screen for approximately 2 seconds after you release the zoom button.

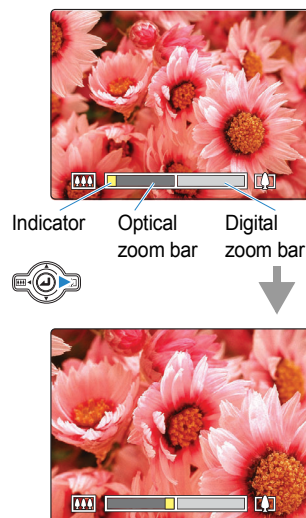

NEXT 

2 When the image is fully zoomed in, release the selector lever and then move the selector lever right again.

This camera can zoom from x1.3 to x6.0 in 15 steps of 1/3 zoom.
(Digital Zoom)

When shooting still images, the range of magnification available using digital zoom depends on the image size (→ p.78), as shown below.

When shooting movies, the magnification is not related to the number of pixels, and the maximum zoom is x2.0.

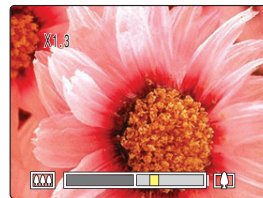
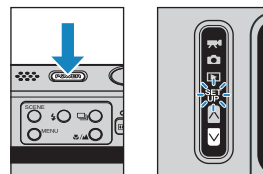

Image Size	Available digital zoom magnification
2272 x 1704	up to 4.0x
1600 x 1200	up to 5.0x
1280 x 960	up to 6.0x
640 x 480	up to 6.0x

Switching the Digital Zoom ON and OFF

You can use the procedure below to set digital zoom ON or OFF.

1 Turn the camera on and press the mode button until "SET UP" lights up on the mode select LED.



2 Move the selector lever up or down to select [DIGITAL ZOOM], then move the lever right .

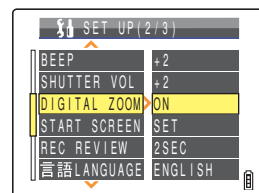

3 Move the selector lever up ▲ or down ▼ to select the desired setting, then press



The selected setting is applied.

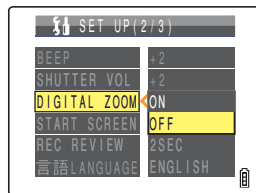

! Important This setting is retained when you turn the camera off.

📝 Note The digital zoom bar is not displayed when digital zoom is set to [OFF].



Using the Flash

«Applicable mode: »

This camera has an **Automatic Flash mode** in which the camera determines whether or not to fire the flash based on the ambient light level. However, there is also a range of other flash modes that you can use to achieve particular effects in your shots.

! Important When using the flash for close-up shots, you should set the ISO sensitivity to 200 or less. If you set the sensitivity to a high ISO setting and then take close-up shots, the image will be overexposed.

Flash Modes

Auto Flash mode

The camera detects the ambient light level and determines whether to fire the flash.

Red-eye Reduction Auto mode

In this mode, the flash reduces the red-eye effect by firing twice: once just before and again when the picture is taken. As in Auto Flash mode, the camera detects the ambient light level and determines whether to fire the flash.

! Important The shot is taken the second time the flash fires, not the first time. Take care to ensure that neither the camera nor the subject move after the flash fires the first time.

Flash Off mode

In this mode, the flash never fires, regardless of the ambient light levels. This mode is best for shots of sunsets or shots where you want to retain an indoor ambiance.

! Important



- Because the shutter speed used may be slow, depending on the light level, you should place the camera on a stable surface and use the self-timer (→ [p.58](#)) to prevent camera shake when the shot is taken.
- If the photographed image is too dark, use the exposure compensation (→ [p.67](#)) or ISO sensitivity (→ [p.69](#)) settings to adjust the brightness.

Fill-in Flash mode

In this mode, the flash fires regardless of the ambient light conditions. When you take a picture in strong sunlight or when the subject is backlit, this mode allows you to take a picture that clearly shows both the subject and the background.

NEXT 

Setting the Flash Mode

- 1 Turn the camera on and press the mode buttons   until "CAM" lights up on the mode select LED.

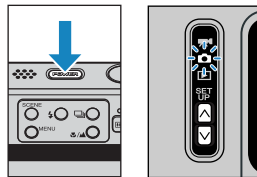

- 2 Press the flash button  to select the icon for the mode you want to set.

The flash mode icon changes in the cycle shown below each time you press the flash button .

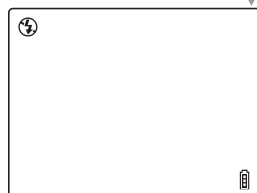
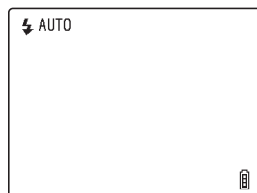
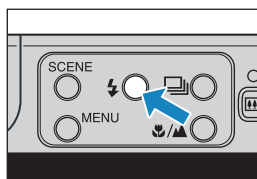
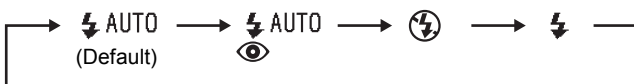

Note

This setting reverts to the default value when you turn the camera off.



Flash settings for each modes

There are limitations on flash settings when using Scene modes (→ [p.53](#)) or Macro/Landscape mode (→ [p.56](#)).

 **Note** It is recommended that you use the default flash settings in each of these modes.

Scene mode

Scene mode	Available flash modes
Sports Action	⊕ Flash Off mode (Default), ⚡ Fill-in Flash mode ⚡ ^{AUTO} Auto Flash mode, ⚡ ^{AUTO} Red-eye Reduction Auto mode
Portrait	⚡ ^{AUTO} Red-eye Reduction Auto mode (Default), ⊕ Flash Off mode ⚡ Fill-in Flash mode, ⚡ ^{AUTO} Auto Flash mode
Sunset	⊕ Flash Off mode
Night Portrait	⚡ ^{AUTO} Red-eye Reduction Auto mode (Default), ⚡ ^{AUTO} Auto Flash mode
Twilight	⊕ Flash Off mode
Night View	
Black and White	⚡ ^{AUTO} Auto Flash mode (Default), ⚡ ^{AUTO} Red-eye Reduction Auto mode
Sepia	⊕ Flash Off mode, ⚡ Fill-in Flash mode

 **Note** When the Scene mode returns to Normal mode, the flash mode reverts to the last flash mode selected in Normal mode. However, if you change the flash mode while in a Scene mode, that flash mode is retained when you return to Normal mode.

Macro/Landscape mode

Macro/Landscape mode	Available flash modes
Macro	⊕ Flash Off mode (Default), ⚡ Fill-in Flash mode
Landscape	⊕ Flash Off mode

 **Note**

- The flash mode reverts to the last flash mode set in Normal mode when the Macro/Landscape mode returns to Normal. However, if you change the flash mode while in Macro mode, that flash mode is retained when you return to Normal mode.
- Using the Fill-in Flash mode while in Macro mode will result in over-exposure.



■ Effective flash range

The effective flash range varies depending on parameters such as zoom and ISO sensitivity (→ [p.69](#)) settings.

When taking pictures, refer to the distances shown in the figure at the right.

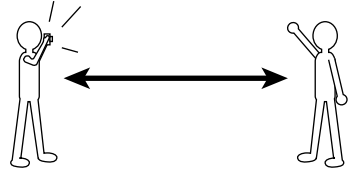



Wide-Angle : Approx. 0.6m to 2.5m
Telephoto : Approx. 0.9m to 1.8m
(ISO: AUTO)



Adjusting the Brightness

[] Using Exposure Compensation

«Applicable mode:  »

Use exposure compensation to adjust the brightness of your images. This function is especially useful for shots where you did not get the ideal **exposure** because the brightness of the subject and background were very different. You can also use this feature when you deliberately want to shoot under- or over-exposed images.

This camera allows you to adjust the brightness up to plus or minus 2.0 EV in 1/3 EV increments.

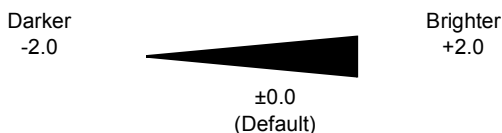

1 Turn the camera on and press the mode buttons   until "" or "" lights up on the mode select LED.

2 Press the MENU button  to display the menu icons.

3 Move the selector lever left  or right  to select EXP.COMP. [] and press .

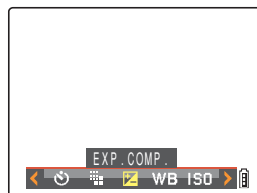

4 Move the selector lever up  or down  to select the desired compensation value and press .

The compensation value is now set to the selected value.

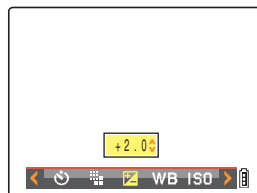

NEXT 

5 Press the MENU button .

The specified value appears on the LCD monitor.

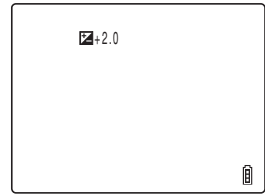

! Important

- The exposure compensation setting does not change after a shot is taken.
- This setting reverts to the default value when you turn the camera off.
- When the flash is used, exposure compensation is limited to between -1.0 and +1.0 EV.

Note

You cannot set the exposure compensation in Night View mode.



[ISO] Changing the ISO Sensitivity to Shoot Fast Moving Subjects

«Applicable mode: »



The [ISO] setting corresponds to the ISO value of conventional film and indicates sensitivity to light.

The ISO sensitivity options in this mode are [AUTO], [50], [100], [200] and [400]. The default setting is [AUTO], in which case the camera automatically chooses the ISO sensitivity to suit the ambient conditions. Although the image quality is worse for higher values, the sensitivity to light is better, allowing you to take shots in dark locations and use the high-speed shutter. This also slightly increases the effective range of the flash.

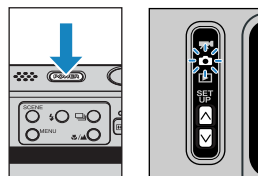
- 1 Turn the camera on and press the mode buttons   until "C" lights up on the mode select LED.



- 2 Press the MENU button  to display the menu icons.

- 3 Move the selector lever left  or right  to select ISO [ISO] and press .



- 4 Move the selector lever up  or down  to select the desired sensitivity and press .

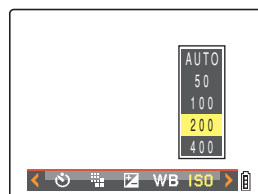

The ISO sensitivity is now set.

(No icon) [AUTO]: The camera sets the ISO sensitivity to suit the ambient conditions. (Default)

[ISO50] [50] : Fixed at ISO 50

[ISO100] [100] : Fixed at ISO 100

[ISO200] [200] : Fixed at ISO 200

[ISO400] [400] : Fixed at ISO 400



5 Press the MENU button .

The icon for the specified value appears on the LCD monitor.



! Important This setting is retained when you turn the camera off.

📝 Note [AUTO] is used in Sports Action, Portrait, Sunset, Night Portrait, Twilight and Night View modes.

[METERING] Selecting the Area Used for Setting the Exposure

«Applicable mode: »

In this mode, you can select the area that the camera uses to set the exposure. The available settings are [EVALUATION], [CENTER] and [SPOT AREA]. Use the setting that best suits your subject.

[EVALUATION] : The screen is partitioned into zones and the optimum exposure is determined based on measurements of the light in each zone. Because this mode allows ordinary shots or even backlit shots to be taken with little or no exposure compensation, it is recommended for novices or for users who want to take pictures without having to worry about the exposure settings.

[CENTER] : The exposure is determined by giving particular weight to measurements of the light from the subject that strikes the central part of the screen. This mode makes it easy for the camera to set the exposure even in shots where there is a strong light source close to the subject.

[SPOT AREA] : The camera determines the exposure by measuring only the light from the subject that strikes the center of the screen. This mode should be used for shots where there is a strong contrast in brightness between the subject and the background, such as a backlit portrait or a shot of a performance where the lighting is focused on a specific part of the stage. You can also use this mode to measure the light from a particular part of your subject when you are trying to achieve a specific effect.

(Area measured)

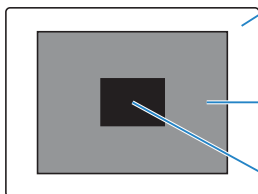

Area measured in [EVALUATION] mode



Measures by splitting the entire screen into zones.

Area measured in [CENTER] mode

Measures the central part of the screen.

Area measured in [SPOT AREA] mode

Only measures a single point in the center of the screen.

1 Turn the camera on and press the mode buttons   until "O" lights up on the mode select LED.

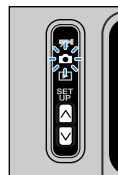
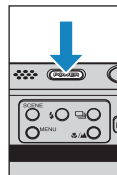

2 Press the MENU button  to display the menu icons.



3 Move the selector lever left ◀ or right ▶ to select **METERING** [] and press [OK].

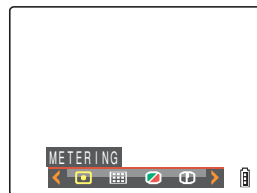

4 Move the selector lever up ▲ or down ▼ to select the desired setting and press [OK].

The metering mode is now set.

(No icon) [EVALUATION] : The entire screen is partitioned into 256 zones and the light in each zone is measured to determine the optimum exposure for the subject. (Default)

[] [CENTER] : The exposure is determined by measuring the light and giving greater weight to the central part of the screen (an area larger than that used for spot metering).

[] [SPOT AREA] : The exposure is determined by measuring the light at the center of the screen.

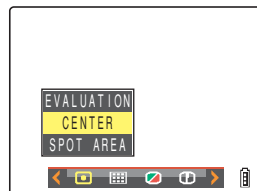

5 Press the **MENU** button [MENU].

The icon for the selected metering mode appears on the LCD monitor.

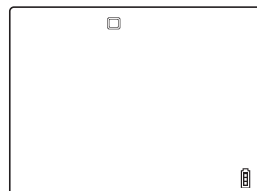



! Important This setting is retained when you turn the camera off.



Setting the Focus

[FOCUSING] Selecting the Focusing Method

«Applicable mode:  »

You can select either of 2 automatic focusing modes: [MULTI AF] or [SPOT AF].

[MULTI AF] : The camera automatically chooses the location to focus on from multiple points on the screen. This mode uses a wide focusing frame, and is useful for shots such as photos of 2 people standing side by side. (Default)

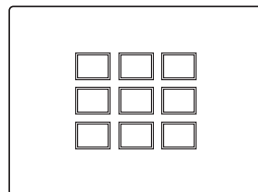

When you press the shutter release button half way, the one location out of the nine focus frames that is focused is displayed.

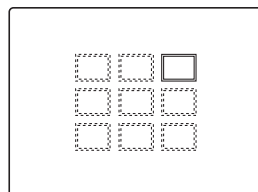

[SPOT AF] : Use this mode to focus on a specific part of your subject. You should also use this mode when you use focus lock to take pictures.

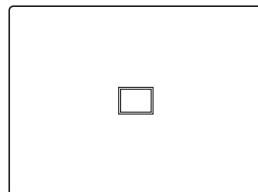

* When the subject you want to focus on is not inside the focus frame, use focus lock to set the focus.

("Focusing Off-Center (Focus Lock)" → p.75)

1 Turn the camera on and press the mode buttons   until "" or "" lights up on the mode select LED.

2 Press the MENU button  to display the menu icons.

NEXT 

3 Move the selector lever left ◀ or right ▶ to select **FOCUSING** [] and press .



4 Move the selector lever up ▲ or down ▼ to select the desired mode and press .

The focusing frame is now set.

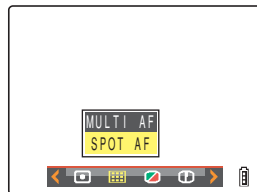

5 Press the MENU button .

The selected focusing frame appears on the LCD monitor.

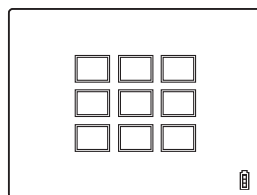
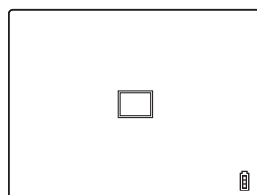



! Important

- This setting is retained when you turn the camera off.
- In Twilight mode, Night View mode and Landscape mode, the focus is fixed at infinity and the [FOCUSING] setting cannot be changed. The focus frame is not displayed.



Focusing Off-Center (Focus Lock)

«Applicable mode:  »

Use Focus Lock in situations where the subject you want to focus on is not in the center of the image, or when you want to compose a shot where the focal point is not in the center of the shot.

1 Turn the camera on and press the mode buttons   until "AF" or "AE" lights up on the mode select LED.

2 Position the focusing frame over the subject you want to focus on and press the shutter release button half way.

The camera gives a short double-beep, the green shooting mark "●" lights on the LCD monitor and the focus frame turns green to indicate that the focus has been set and locked. (Focus Lock, AE Lock)

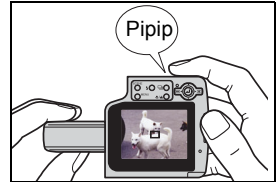

Note

- The shooting mark "●" flashes when the focus is not set. Press the shutter release button half way again until the shooting mark "●" stays lit and the focus is set, or focus on the other subject.
- When the focus frame (→ p.73) is set to [MULTI AF], the selected focus frame turns green.
- There is no focus frame displayed when the focus is fixed at infinity (Twilight mode, Night View mode, and Landscape mode).

3 With the shutter release button still half-pressed, move the camera until the shot is composed as you want it.

4 Press the shutter release button down fully.

Removing your finger from the shutter release button releases the Focus Lock and AE Lock.

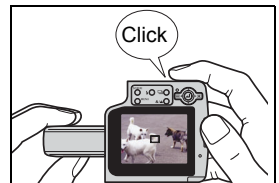

■ Subjects That Are Difficult to Focus On

The camera has difficulty focusing on the following types of subject. Lock the focus on another object at the same distance from the camera as the desired subject and then take the picture.

- Low contrast subjects
- Objects that consist of the same pattern repeated
- Dark subjects
- Subjects made up only of horizontal lines
- Extremely bright or glossy subjects
- Subjects where there is a strong light source in or near the field of view, or when there is strong light such as sunlight in the LCD monitor image
- When there are 2 or more subjects in or near the center of the field of view that are at different distances from the camera
- Very fast moving subjects



[AF MODE] Still and Moving Subjects

«Applicable mode: »

This setting selects the method the camera uses to automatically set the focus.

[SAF] : (Single Auto Focus) (Default): Best for normal photography.

The camera sets the focus when you press the shutter release button half way. When the shot is focused, the green shooting mark appears to show that focus and exposure are set. Continue pressing the shutter release button down fully to take the shot.

[CAF] : (Continuous Auto Focus): Best for moving subjects.

While the camera is turned on, it continuously adjusts the focus. With the shutter release button pressed half way down, check that the shooting mark is shown and then simply press the shutter release button down fully to take the shot.

1 Turn the camera on and press the mode button until "SET UP" lights up on the mode select LED.

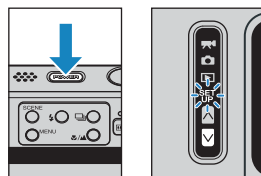

2 Move the selector lever up or down to select [AF MODE], then move the lever right .

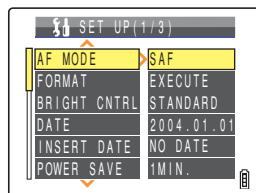

3 Move the selector lever up or down to select the desired AF mode and press .

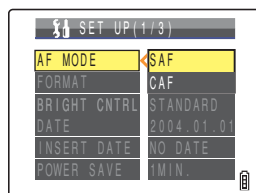



The AF mode is now set.

! Important

- This setting is retained when you turn the camera off.
- Even when [CAF] is selected, the auto focus may not be able to successfully track some fast-moving subjects.
- Selecting [CAF] uses up battery power more quickly.





Selecting the Number of Pixels

«Applicable mode:  »

The number of pixels refers to the number of individual dots used to make up the image. The larger this number, the better the image quality. However, this also increases the size of the image file so that fewer pictures can be taken. Choose the image size that best suits the intended use of the shot.

(→ [p.79](#))



1 Turn the camera on and press the mode buttons   until "" or "" lights up on the mode select LED.

2 Press the MENU button  to display the menu icons.

3 Move the selector lever left  or right  to select the PIXELS  and press .

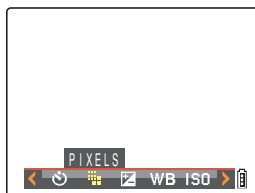
Notes about the desired use are displayed next to each image size.



4 Move the selector lever up  or down  to select the desired number of pixels and press .

The image size setting is set.

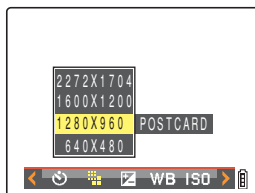

5 Press the MENU button .

The icon for the selected image size appears on the LCD monitor.

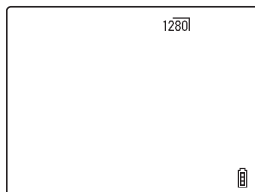

! **Important** This setting is retained when you turn the camera off.

NEXT 



■ Guide to Selecting the Number of Pixels

For high-quality printing or to give priority to image quality, choose a large number of pixels (image size). For files you want to send as e-mail attachments, choose a small image size to keep the file size small.

The number of shots that can be taken is smaller if the number of pixels is large, and larger if the number of pixels is small.

It is also possible to further reduce the number of pixels in an image after shooting. (→ [p.114](#))

Still Images

Number of Pixels	Intended Use (Notes)	Image Quality	Number of available shots
2272 x 1704 (Default)	A4 or larger sized prints	High  Low	Few  Many
1600 x 1200	A5 or larger sized prints		
1280 x 960	Postcard sized prints		
640 x 480	Sending as an email attachment*		

* When you are attaching images to an email to send to a mobile phone, the number of pixels that can be used varies depending on the mobile phone you are using. Refer to the instruction manual for the mobile phone you are using for details.



Movies

Number of Pixels	Intended Use (Notes)	Image Quality	Available Shooting Time
640 x 480	Recording with quality equivalent to television	High	Short
320 x 240 (Default)	Shooting for relatively long periods	Low	Long













Adjusting Image Colors and Other Settings

[WB] Selecting the Light Source (White Balance)



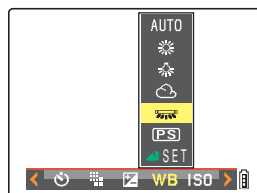

«Applicable mode:  »

The color of a subject varies depending on the light source used. Setting the white balance is the process by which image colors are calibrated to ensure that photographed objects appear in their true colors regardless of the light source used.

- 1 Turn the camera on and press the mode buttons   until "" or "" lights up on the mode select LED.
- 2 Press the MENU button  to display the menu icons.
- 3 Move the selector lever left  or right  to select **WHITE BALANCE [WB]** and press .
- 4 Move the selector lever up  or down  to select the desired setting and press .



The white balance setting is updated.

[AUTO] Automatic	Automatically sets the white balance to suit the ambient conditions. (Default)
[] Daylight	Specifies the light source.
[] Incandescent	
[] Cloudy	
[] Fluorescent	
[[PS]] Preset	Uses the white balance specified in [WB PRESET]. This value must be set beforehand.
[[SET]] WB Preset	Allows you to configure the white balance by yourself.



5 Press the MENU button .

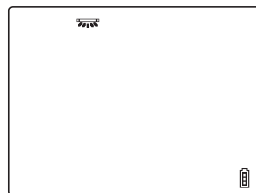

The icon for the selected white balance setting appears on the LCD monitor.



Important This setting is retained when you turn the camera off.

Note In Sunset mode, Twilight mode, Black and White mode, and Sepia mode, the white balance is automatically configured as suitable for the mode and cannot be changed.



Configuring white balance manually

«Applicable mode:  »

You can configure the white balance by yourself when there are multiple light sources, or to accurately calibrate white. Reconfigure each time the light source changes.

1 Turn the camera on and press the mode buttons   until "☞" or "☞" lights up on the mode select LED.

2 Press the MENU button  to display the menu icons.

3 Move the selector lever left  or right  to select WHITE BALANCE [WB] and press .



4 Move the selector lever down  to select [SET] and press .

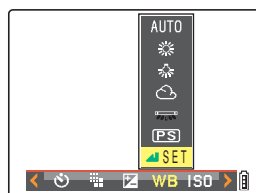

5 Position your prepared white sample so that it fills the frame on the screen.

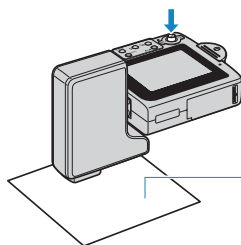

White subject,
such as paper.

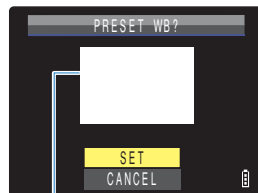

Adjust the subject to fill
the frame on the screen.

6 Move the selector lever up ▲ to select [SET], then press ⏏.

The preset value for the white balance is set.

To cancel this setting, select [CANCEL] and press ⏏.

7 Press the MENU button .

The white balance is set to [**PS**].

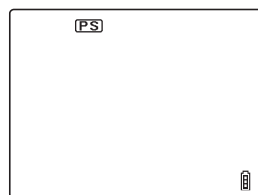

! Important This setting is retained when you turn the camera off.



📝 Note In Sunset mode, Twilight mode, Black and White mode, and Sepia mode, the white balance is automatically configured as suitable for the mode and cannot be changed.



[CHROMA] Changing the color intensity

«Applicable mode: »

The [CHROMA] setting lets you take pictures in which the intensity of the colors is increased (brighter colors) or decreased (paler colors).

1 Turn the camera on and press the mode buttons   until "C" lights up on the mode select LED.

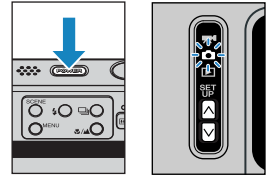

2 Press the MENU button  to display the menu icons.

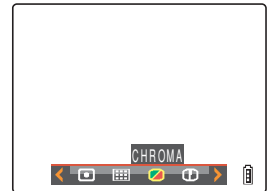

3 Move the selector lever left  or right  to select CHROMA  and press .

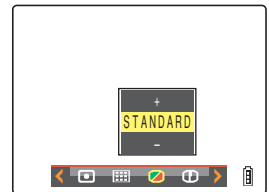

4 Move the selector lever up  or down  to select the desired setting and press .



The chroma settings is updated.

  : Increases the color intensity.

(No icon) [STANDARD]: Uses the standard color intensity. (Default)

  : Decreases the color intensity.

5 Press the MENU button .

The icon for the selected intensity appears on the LCD monitor.



! Important This setting is retained when you turn the camera off.



 Note The [STANDARD] setting is used in Black and White mode and Sepia mode.



[SHARPNESS] Enhancing the Image Outlines

«Applicable mode: »

This setting enables you to take pictures in which the subject's outline is sharpened or softened.

- 1 Turn the camera on and press the mode buttons   until "CAM" lights up on the mode select LED.**

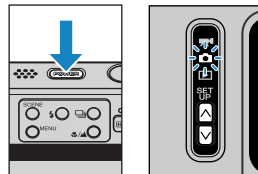

- 2 Press the MENU button  to display the menu icons.**

- 3 Move the selector lever left  or right  to select SHARPNESS  and press .**



- 4 Move the selector lever up  or down  to select the desired setting and press .**

The sharpness setting is updated.

+3 : +3

+2 : +2

+1 : +1

(No icon) : STANDARD (Default)

-1 : -1

Sharper outlines



Softer outlines

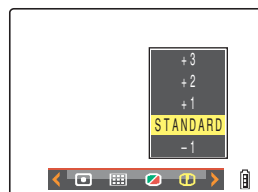

- 5 Press the MENU button .**

The icon for the selected sharpness appears on the LCD monitor.

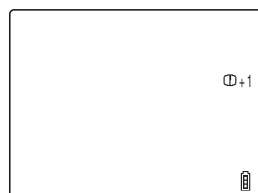

! Important This setting is retained when you turn the camera off.



Playback

This chapter explains how to use your camera's playback modes to check your images.

▼ **Click on the section you want to read.**

Viewing Still Images



Viewing Multiple Images



Viewing Continuous Shooting Images



Viewing Movies



Viewing Images with Auto Play



Erasing Unwanted Images



Protecting Images



Using Postrecording to Add Voice Messages



Resizing Images



Rotating Images



Specifying DPOF Settings



Printing with PictBridge



Connecting to a Windows PC



Connecting to a Macintosh



Connecting to a Television



Viewing Still Images

«Applicable images: Still images only»

1 Turn the camera on and press the mode buttons until "▶" lights up on the mode select LED.



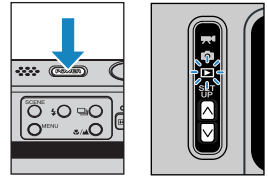

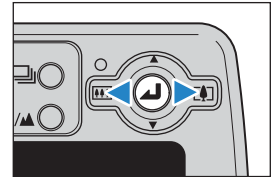

The last image shot appears on the LCD monitor.



2 Move the selector lever left or right to select the image to view.



The table below shows the operations that can be performed during playback.

Operation	Description
Selector lever up 	Switches to the File No display and the information display. (→ p.88)
Selector lever down 	Erases the image. (→ p.103)
Selector lever left 	Displays images in reverse order. Hold the lever left for more than one second to scroll through the images at high speed.
Selector lever right 	Displays images in forward order. Hold the lever right for more than one second to scroll through the images at high speed.
	Enlarges the image for playback. (→ p.87)
SCENE button 	Protects the image. (→ p.107)
Continuous shooting button 	Plays back the group of continuous shots if the image belongs to a group of continuous shots. (→ p.94)

Note



- Any resized images are displayed before the normal images.
- Resized images are displayed at different sizes depending on the image size. When this occurs, the resize icon  appears in the top-left corner of the LCD monitor. For more information on resizing images, see "[Resizing and Trimming Images \(RESIZE\)](#)" (→ [p.114](#)).

NEXT 

Viewing Your Images Enlarged

«Applicable images: Still images only»

You can move the selector lever ◀▶ to enlarge an image during playback.

- 1 Turn the camera on and press the mode buttons   until "▶" lights up on the mode select LED.

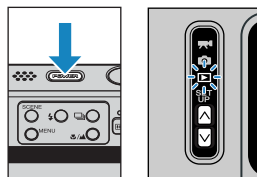

- 2 Move the selector lever left ◀ or right ▶ to select the image to playback.



- 3 Press  to display the zoom magnification adjustment screen.



- 4 Move the selector lever right ▶  .





The image is enlarged as follows each time you move the selector lever right ▶ : 2x → 4x → 8x.

Note

- To restore a magnified image to its original size, move the selector lever left ◀ . The image reverts to its original size in 3 steps each time you move the selector lever ◀ , as follows: 4x → 2x → original size.
- To quickly return an enlarged image to its original size during zoomed playback, simply press the MENU button .





5 Press to display the zoom area movement screen.

Move the selector lever up, down, left or right  to scroll the image in that direction.

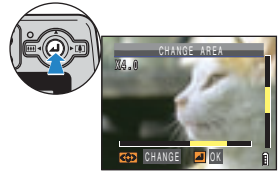
Press  again to accept the selected magnification and area and return to the playback screen (zoomed playback).



Note

- Scroll bars are displayed at the bottom and on the right side of the zoom area movement screen. The scroll bars act as a guide to which part of the original image is currently displayed.
- During zoomed playback, move the selector lever left  or right  to move forwards or backwards through the images while keeping the same magnification and area selection.

Important

- Resized images cannot be viewed enlarged using zoomed playback.
- When you are enlarging images with a postrecording attached, perform this step while the File No screen is displayed (→ p.88).

Viewing Image Information (File No/INFORMATION)

«Applicable images: Still images / movies»

You can use the procedure below to check information such as the aperture and shutter speed used to record an image.



1 Move the selector lever up while the image is being displayed.

The information for the displayed image appears.

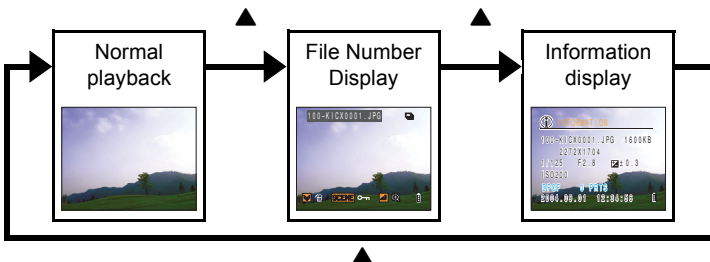
The screen changes in the following order each time the selector lever is moved up .



Important

For movies, moving the selector lever up  only adjusts the audio volume, and does not display any information. To view movie information, first display the information for a still image, then move the selector lever left  or right  to select the movie.



 **Note**

- Refer to [p.24](#) for details of the screen displayed.
- Press the MENU button  when information is displayed to return to the normal playback screen.



[🖼️] Viewing Multiple Images

«Applicable images: Still images / movies»

In addition to the standard **SINGLE** playback mode, the camera has **MULTI** playback and **GROUP** playback modes that show multiple thumbnail images.

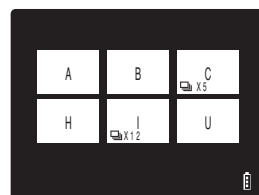
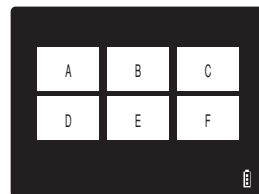

- **MULTI** playback : 6 small (thumbnail) images are shown on the screen at the same time. All of the images from each group of continuous shots are shown separately.
- **GROUP** playback : 6 small (thumbnail) images are shown on the screen at the same time. Only the first image from each series of continuous shots (image group) is shown.



Note

You can playback continuous shots, postrecord messages, protect images, erase one or more images, resize images, run a slideshow, specify the settings for printing and use PictBridge from the MULTI playback / GROUP playback screens.

Displaying multiple images

- 1 Turn the camera on and press the mode buttons   until "▶" lights up on the mode select LED.

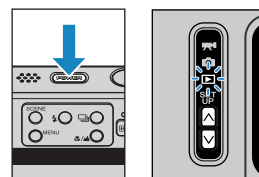

- 2 Press the MENU button  to display the menu icons.

NEXT 

3 Move the selector lever left ◀ or right ▶ to select **DISPLAY MODE** [⊞] and press [OK].

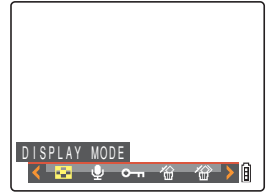

4 Move the selector lever up ▲ or down ▼ to select **[MULTI]** or **[GROUP]**, then press [OK].

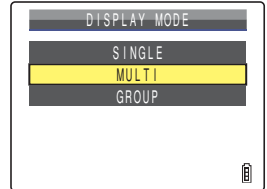

A list of image thumbnails is shown.



■ Using the MULTI playback / GROUP playback screen

MULTI Playback

DPOF icon:

Indicates that print settings have been specified for the image.

Current frame number/Total number of frames:

Shows the position of the selected image relative to the total number of photographed images.

Protect icon:

Displayed for images that have been protected.

To previous image (backwards)

Sound icon

Displayed for movies with sound and for images with postrecorded messages.

[R] Resize icon:

Displayed for resized images.

Movie icon

Displayed for movies.

Cursor

To next image (forwards)

Move the selector lever left ◀ to step backwards and right ▶ to step forwards through the images. Hold the selector lever left ◀ or right ▶ to move rapidly through the pages of images. Move the selector lever up ▲ or down ▼ to move up or down a layer.

GROUP Playback

Protect icon:

Displayed for images that have been protected. For groups of continuous shots, this is only displayed if all of the images in the group are protected.

To previous image (backwards)

Current frame number/Total number of frames:

Shows the position of the selected image relative to the total number of photographed images. In the case of groups of continuous shots, the sequence number of the first image is shown.

Cursor

To next image (forwards)

Continuous shooting icon / Number of continuous shots

In GROUP playback mode, the icon is displayed on the first image of a group of continuous images. The number of continuous shots shows the total number of images in each group.



To return to normal playback (SINGLE playback)

1 In **MULTI playback / GROUP playback mode**, move the selector lever up, down, left or right ▲▼◀▶ to select the image to be viewed in the normal playback mode.

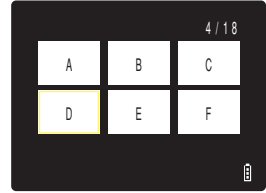

2 Press .



Note

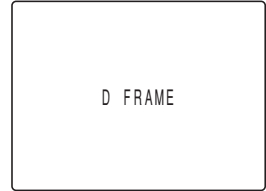

For GROUP playback mode, when you select an image that belongs to a group, the first image from that group is displayed in SINGLE playback mode.





Viewing Continuous Shooting Images

«Applicable images: Continuous shooting images only»

Each series of continuous shooting images (image group) is automatically played back continuously.

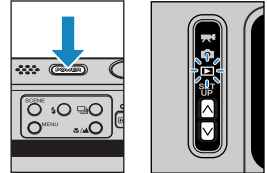

1 Turn the camera on and press the mode buttons   until "▶" lights up on the mode select LED.

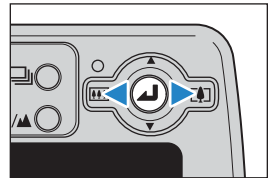

2 Move the selector lever left  or right  to select the continuous shooting images to playback.





Note

- You can also playback continuous shooting images using the MULTI playback and GROUP playback (→ [p.90](#)).
- In SINGLE playback mode, you can easily search for groups of continuous shots by moving the selector lever up  to switch to the File No screen and display  on groups of continuous shots.
- In SINGLE playback and MULTI playback modes, you can view the image group starting at any image within the group. For example, if you begin continuous playback from the third image in a group of 6 images, images are displayed in the order 3 → 4 → 5 → 6 → 1 → 2 → 3.
- If you playback a group of continuous shots from the zoomed display, the zoomed area is fixed during the playback.

NEXT 

3 Press the continuous shooting button .

Note

Press the continuous shooting button  again or press the MENU button  to stop the playback of continuous shooting images.

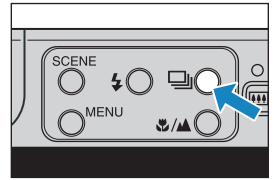

Important



When you erase a single image from within a group of continuous images, the group splits into 2 groups of continuous images.







Viewing Movies

«Applicable images: Movies only»

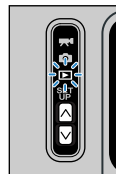
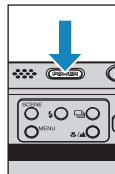
While playing movies, you can pause playback, move forward one frame at a time (frame advance) and adjust the volume.

1 Turn the camera on and press the mode buttons   until "" lights up on the mode select LED.



2 Move the selector lever left  or right  to select the movie to playback, and up  or down  to adjust the volume.

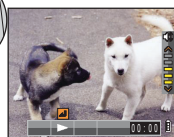

 **Note**



- You can also adjust the playback volume while the movie is running.
- You can view image information before playing back a movie. (→ [p.88](#))

3 Press .

Movie playback begins.

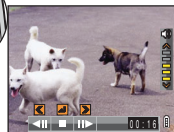
The table below shows the operations that can be performed during playback.



Operation	Description
Selector lever up 	Increases the volume.
Selector lever down 	Decreases the volume.
Selector lever left 	Move selector lever once to stop the movie, and then begin scanning backwards through the movie frame by frame each time you move the selector lever. Hold the lever left for 1 second to scan back through the movie at twice the playback speed. Hold the lever left for another 2 seconds to scan back through the movie at 4 times the playback speed.

NEXT 

Operation	Description
Selector lever right ►	Move selector lever once to stop the movie, and then begin scanning forwards through the movie frame by frame each time you move the selector lever. Hold the lever right for 1 second to scan forward through the movie at twice the playback speed. Hold the lever right for another 2 seconds to scan forward through the movie at 4 times the playback speed.(Sound is not played back during forward scanning.)
⏸	Press to stop movie playback.



Viewing Images Automatically as a Slideshow (Auto Play)

«Applicable images: Still images / movies»

The camera's [AUTO PLAY] (slideshow) function displays your images at set intervals in the order in which they were photographed. AUTO PLAY can playback sound for movies and for images with postrecorded messages. You can also specify the effect used for the transition between images.

[AUTO PLAY] settings

You can specify the following settings for an [AUTO PLAY] slideshow:

- [INTERVAL] : The delay between images
- [START FRAME] : The first image in the slideshow
- [RECORD/MOVIE]: Playback postrecorded voice messages and movies
- [EFFECT] : The effect used in the transition between images

 **Note** These settings can also be used in MULTI playback / GROUP playback modes (→ p.90).

1 Turn the camera on and press the mode buttons   until "▶" lights up on the mode select LED.

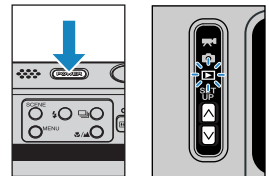

2 Press the MENU button  to display the menu icons.

3 Move the selector lever left  or right  to select AUTO PLAY  and press .

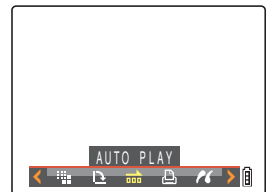

NEXT 

4 Move the selector lever up ▲ or down ▼ to select [INTERVAL], then move the lever right ►.

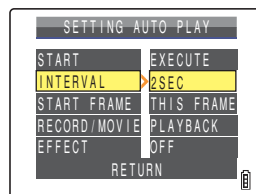

5 Move the selector lever up ▲ or down ▼ to select the desired value, then press ⏪.

The available intervals are 2, 10, 15 and 30 seconds.

Note

The recorded duration of movies and postrecordings takes precedence over the playback interval setting.

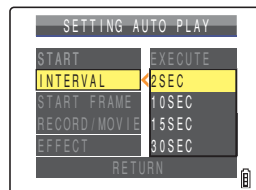

6 Move the selector lever up ▲ or down ▼ to select [START FRAME], then move the lever right ►.

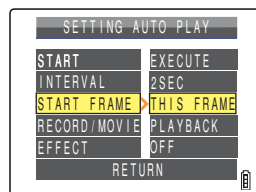

7 Move the selector lever up ▲ or down ▼ to select the starting image, then press ⏪.

[THIS FRAME] : Starts playback from the currently displayed image.

[1ST FRAME] : Starts playback from the image with the lowest number in the file name.

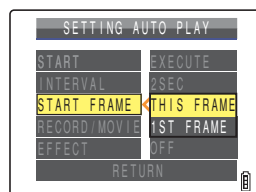

8 Move the selector lever up ▲ or down ▼ to select [RECORD/MOVIE], then move the lever right ►.

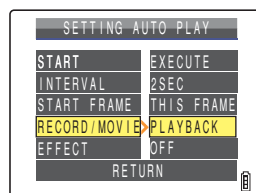

9 Move the selector lever up ▲ or down ▼ to select the playback method, then press .

[PLAYBACK] : Postrecorded voice messages and movies are included in the slideshow.

[NOPLAYBACK]: Postrecorded voice messages and movies are not included in the slideshow.

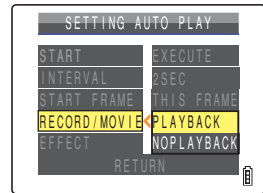

10 Move the selector lever up ▲ or down ▼ to select [EFFECT], then move the lever right ►.

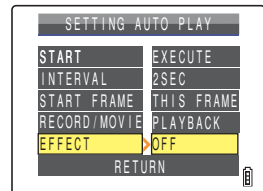

11 Move the selector lever up ▲ or down ▼ to select the desired effect, then press .

[OFF] : No effect is set.

[FADE] : The current image gradually darkens (fades out) and the next image gradually fades in.

[OVERLAP] : The next image slides over the current image and replaces it.

[SHUTTER] : Black curtains close from the top and bottom of the screen to erase the current image, after which the black curtains open again towards the top and bottom to reveal the next image.

[WIPE] : The current image disappears as if wiped away from the left and is replaced by the next image.

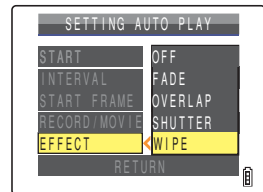

12 Press the MENU button .



Starting and Ending an [AUTO PLAY] Slideshow

See [p.98](#) for more information on the [AUTO PLAY] settings.

- 1 Turn the camera on and press the mode buttons   until "▶" lights up on the mode select LED.

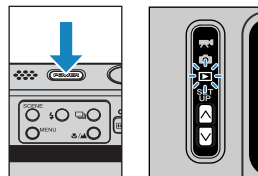

- 2 Press the MENU button  to display the menu icons.

- 3 Move the selector lever left  or right  to select AUTO PLAY  and press .

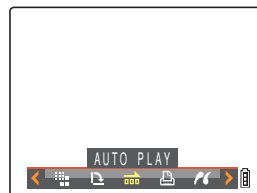

- 4 Move the selector lever up  to select [START], then press .

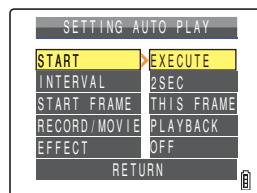



The slideshow begins.

Note

Press the MENU button  to end a slide show in progress.



The table below lists the operations you can perform while a movie or a still image with a postrecorded message is being played back.

Operation	Description	
	Movies	Still image with postrecorded message
Selector lever up ▲	Increases the volume.	Increases the volume.
Selector lever down ▼	Decreases the volume.	Decreases the volume.
Selector lever left ◀	Move the selector lever once to stop the movie, and then begin scanning backwards through the movie frame by frame each time you move the selector lever. Hold the lever left for 1 second to scan back through the movie at twice the playback speed. Hold the lever left for another 2 seconds to scan back through the movie at 4 times the playback speed.	Hold the lever left to slow playback down to half speed. Release to resume normal playback.
Selector lever right ▶	Move the selector lever once to stop the movie, and then begin scanning forwards through the movie frame by frame each time you move the selector lever. Hold the lever right for 1 second to scan forward through the movie at twice the playback speed. Hold the lever right for another 2 seconds to scan forward through the movie at 4 times the playback speed.	Hold the lever right to play back the message at double speed. Release to return to normal playback.
	Press to stop movie playback.	Press to stop voice message playback.
MENU button 	Press once to end a slide show in progress.	



[🗑️]/[🗑️] Erasing Unwanted Images

«Applicable images: Still images / movies»

There are 3 methods for erasing images recorded on a memory card:



- [ERASE] : Erases just one image.
- [SELECT AND ERASE]: Erases the images you have selected.
- [ERASE ALL] : Erases all the images on the card.

 **Note** You can also erase images from the MULTI playback / GROUP playback screen (→ [p.90](#)) and Quickview screen (→ [p.51](#)).

Erasing individual images (ERASE)

Use the procedure below to erase a single image.

-  **Important**
- You cannot erase protected images (→ [p.107](#)).
 - Images are displayed as thumbnails in MULTI playback / GROUP playback modes. When erasing continuous shooting images in MULTI playback mode, take care not to mistakenly erase images that you want to keep.
 - When you erase an image with a postrecorded voice message (→ [p.110](#)), the sound file is also erased.
 - There are no camera functions to restore an image once it has been erased. When erasing, take care that you do not erase images that you want to keep.
 - When you erase a single image from within a group of continuous images, the group splits into 2 groups of continuous images.

1 Turn the camera on and press the mode buttons   until "▶" lights up on the mode select LED.

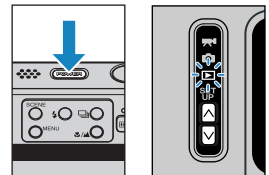

2 Press the MENU button  to display the menu icons.

3 Move the selector lever left  or right  to select ERASE  and press .

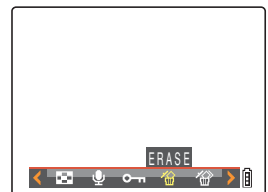

NEXT 

4 Move the selector lever left ◀ or right ▶ to select the image you want to erase.

5 Move the selector lever up ▲ to select [EXECUTE], then press ⏏.

The image is erased and the next image appears.

If there are no further images, the "NO IMAGE" message appears.

Note

- To erase another image, repeat steps 4 and 5.
- When you select an image from a group of continuous shots, a screen is displayed to confirm that you want to erase the group. Move the select lever up ▲ to select [EXECUTE], then press ⏏ to erase all the images from within the group of continuous shots.

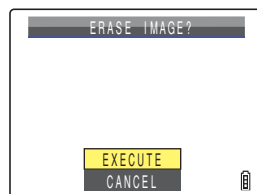

6 Press the MENU button .

Note

In SINGLE playback mode, the erase confirmation screen is displayed when you move the selector lever down ▼, even if you did not choose erase [⊗] from the menu. Move the selector lever up ▲ to select [EXECUTE] and press ⏏ to erase the currently displayed image.

Erasing a selection of images (SELECT AND ERASE)

You can use this function to select images and then erase them collectively.

Important

- You cannot erase protected images (→ [p.107](#)).
- When you erase an image with a postrecorded voice message (→ [p.110](#)), the sound file is also erased.

1 Turn the camera on and press the mode buttons   until "▶" lights up on the mode select LED.

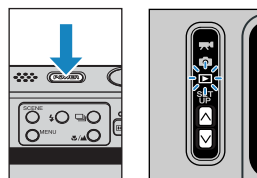

2 Press the MENU button  to display the menu icons.



3 Move the selector lever left ◀ or right ▶ to select ERASE MULTIPLE [🗑️] and press ⏺.

The multiple erase screen appears.



4 Move the selector lever up ▲ to select [SELECT AND ERASE], then press ⏺.

A screen appears in which you can select the images to be erased.

Note The selection screen for erasing images is displayed in MULTI playback mode.

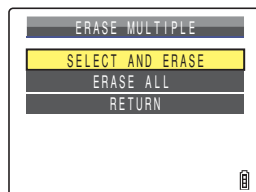

5 Move the selector lever up, down, left or right ▲▼◀▶ to select an image to erase, then press ⏺.

[🗑️] appears next to the selected image. Then repeat this procedure to select the other images you want to erase. To deselect a selected image, select an image marked with the Trash icon [🗑️] and press ⏺.

Note You can select up to 99 images.



6 Press the SCENE button .

A message appears asking you to confirm that you want to erase the images.

7 Move the selector lever up ▲ to select [EXECUTE], then press ⏺.

The selected images are erased.

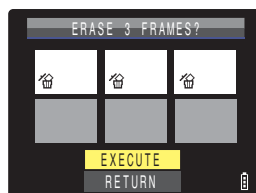

Erasing all the images (ERASE ALL)

You can use the procedure below to erase all the images recorded on a memory card.

- ! **Important**
- You cannot erase protected images (→ [p.107](#)).
 - When you erase an image with a postrecorded voice message (→ [p.110](#)), the sound file is also erased.

1 Turn the camera on and press the mode buttons   until "▶" lights up on the mode select LED.

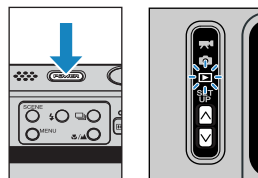

2 Press the MENU button  to display the menu icons.

3 Move the selector lever left  or right  to select ERASE MULTIPLE [] and press .



The multiple erase screen appears.

4 Move the selector lever up  or down  to select [ERASE ALL], then press .

A message appears asking you to confirm that you want to erase the images.

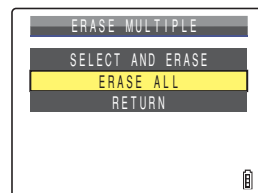

5 Move the selector lever up  to select [EXECUTE], then press .

All the images are erased and the "NO IMAGE" message appears.

- ! **Important** If there are images still shown after you use [ERASE ALL], those images may be protected. To forcibly erase all the images, format the memory card. ("[FORMAT] Initializing a Memory Card" → [p.163](#))

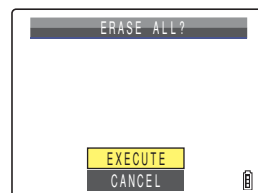

[] Protecting Images from Accidental Erasing (PROTECT)

«Applicable images: Still images / movies»

This feature enables you to protect important images to ensure that they are not inadvertently erased.

Note

These settings can also be changed in MULTI playback / GROUP playback (→ p.90) and QuickView (→ p.51) modes.

Protecting an image

1 Turn the camera on and press the mode buttons   until "" lights up on the mode select LED.

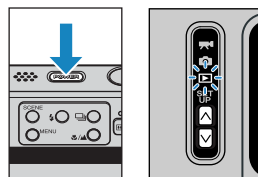

2 Press the MENU button  to display the menu icons.

3 Move the selector lever left  or right  to select PROTECT [] and press .



4 Move the selector lever left  or right  to select the image to be protected.

5 Move the selector lever up  to select [SET], then press .

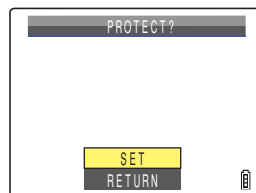

The [] icon appears on protected images.



Note

- To protect another image, repeat steps 4 and 5.
- In GROUP playback, all of the images in a group of continuous shots are protected when you protect an image from a group.

NEXT 

6 Press the MENU button .

Important [ERASE ALL] (→ p.106) does not erase protected images. However, [FORMAT] (→ p.163) erases all of the images on the card, including protected images.

Note In SINGLE playback mode, press the SCENE button  to view the protection settings screen. Move the selector lever up  to select [SET] and press  to protect the currently displayed image.

Unprotecting an image

1 Turn the camera on and press the mode buttons   until "▶" lights up on the mode select LED.

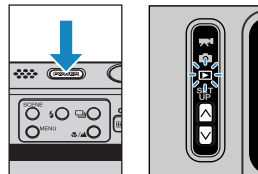

2 Press the MENU button  to display the menu icons.

3 Move the selector lever left  or right  to select PROTECT [] and press .



4 Move the selector lever left  or right  to select the image to be unprotected.

The [] icon is displayed with protected images.

5 Move the selector lever up  to select [EXECUTE], then press .

The image protection is removed.

Note

- To unprotect another image, repeat steps 4 and 5.
- In GROUP playback, all of the images in a group of continuous shots are unprotected when you unprotect an image from a group.

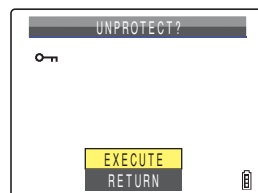

6 Press the MENU button .



■ Tips for Erasing Images Using [PROTECT] and [ERASE ALL]

For example, if you have 100 recorded images and you only want to keep 5 or 6 of them, using [ERASE] or [SELECT AND ERASE] to erase individual images can be very time-consuming.

In a situation like this, where you have a large number of recorded images and you only want to keep a few of them, you can accomplish it in just a few steps using [PROTECT] and [ERASE ALL].

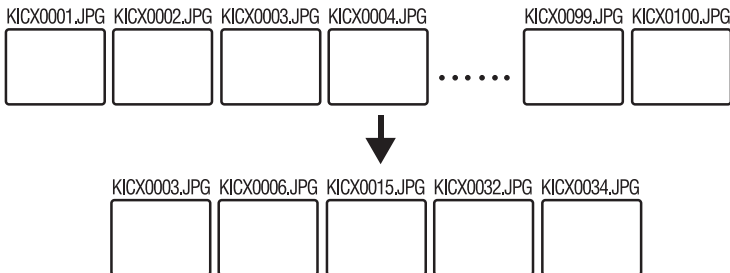

1 First protect the images you want to keep. ("[\square] Protecting Images from Accidental Erasing (PROTECT)" → **p.107**)

2 Then erase all the images. ("Erasing all the images (ERASE ALL)" → **p.106**)

All the unprotected images are erased, leaving just the protected images behind.



[🗣️] Adding Sounds to Still Images (POSTRECORDING)

«Applicable images: Still images only»

This feature allows you to add recorded voice messages to photographed images.

Note

- These settings can also be used in MULTI playback / GROUP playback modes (→ p.90).
- Postrecorded audio is saved in the same folder as the image file, but with a different file extension, as shown below.

DCIM

100CXBOX

KICX0001.jpg

KICX0002.jpg

KICX0002.wav

KICX0003.jpg

•

•

•

— Image file that has had audio attached

— Recorded audio file

Recording a message

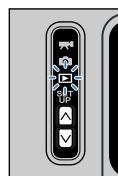
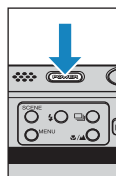

1 Turn the camera on and press the mode buttons   until "📷" lights up on the mode select LED.

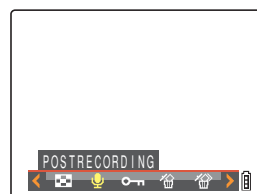

2 Press the MENU button  to display the menu icons.

3 Move the selector lever left  or right  to select POSTRECORDING [🗣️] and press .



4 Move the selector lever left  or right  to select the image to which you want to add the voice message.

NEXT 

5 Move the selector lever up ▲ to select [EXECUTE], then press .

Voice recording begins.

When you speak into the microphone on the front of the camera, the camera records your voice.

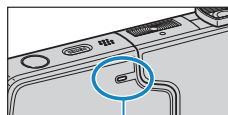

Microphone

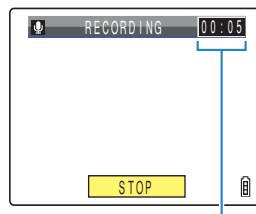
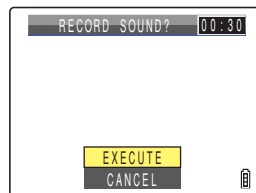

A countdown timer shows the seconds remaining during recording. Messages up to 30 seconds long can be recorded.

6 Press .

Recording stops and the screen in step 3 reappears.

7 Press the MENU button .

! Important

- It may not be possible to record a voice message if there is insufficient space available on the memory card.
- Postrecordings cannot be made for groups of continuous shots, protected images or resized images.
- You may not be able to postrecord audio on images shot with another camera.





Playing back a recorded message

Use the procedure below to play back a postrecorded voice message.

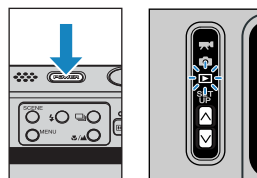
- 1 Turn the camera on and press the mode buttons   until "▶" lights up on the mode select LED.



- 2 Move the selector lever left  or right  to select the image you want to playback.

The [P] icon is displayed for images with a postrecorded message.



- 3 Press .

Voice message playback begins.

The table below shows the operations that can be performed during message playback.

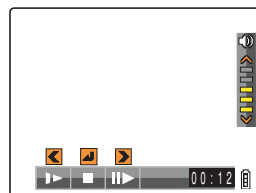

Operation	Description
Selector lever up ▲	Increases the volume.
Selector lever down ▼	Decreases the volume.
Selector lever left ◀	Hold the lever left to play back the message at half speed. Release to return to normal playback.
Selector lever right ▶	Hold the lever right to play back the message at double speed. Release to return to normal playback.
	Press to stop voice message playback.



Erasing a recorded message

Use the procedure below to erase a postrecorded voice message.

- 1 Turn the camera on and press the mode buttons   until "▶" lights up on the mode select LED.

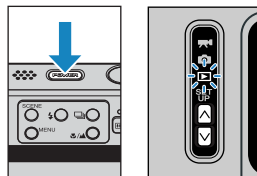

- 2 Press the MENU button  to display the menu icons.

- 3 Move the selector lever left  or right  to select POSTRECORDING  and press .



- 4 Move the selector lever left  or right  to select the image with the voice message you want to erase.

- 5 Move the selector lever up  to select [EXECUTE], then press .

The voice message is erased and the "RECORD SOUND?" message appears.

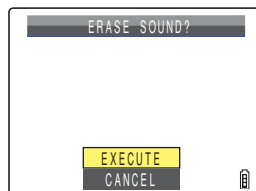

- 6 Press the MENU button .

! Important Audio cannot be erased from protected images.



Resizing and Trimming Images (RESIZE)

«Applicable images: Still images only»

You can use the procedure below to change the number of pixels (resize) in a photographed image and trim off any unwanted portions (trimming). You can select "320 x 240" or "160 x 120" as the number of pixels.

Resized or trimmed images are saved as new image files, so the original images are left untouched.

Important

- You cannot resize groups of continuous shots.
- You may not be able to resize images shot with another camera.
- Resizing may not be possible if there is too little space available on the memory card.
- You cannot perform resizing if the memory card contains the folder 999CXBOX.
- Resized images can be viewed in normal playback but cannot be viewed enlarged using zoomed playback. Note also that resized images cannot be resized again or rotated, and postrecording cannot be used with resized images.

Note

- These settings can also be used in MULTI playback / GROUP playback modes (→ [p.90](#)).
- Resized images are recorded and stored as shown below.

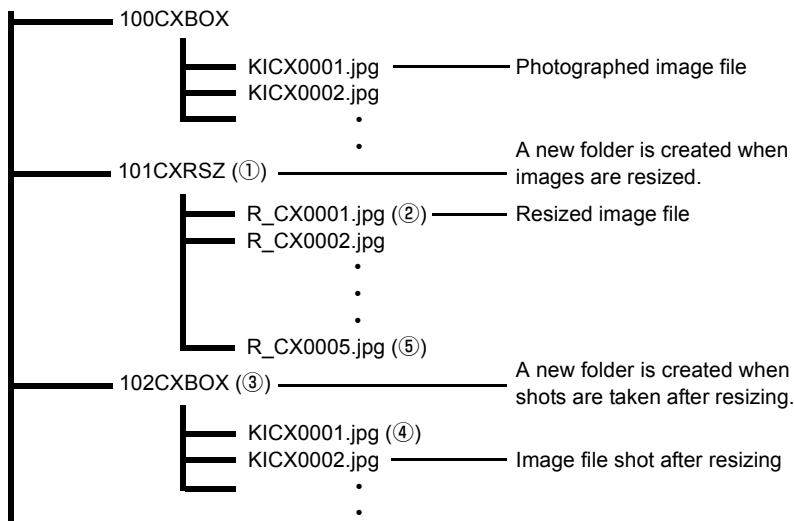

DCIM



- When you resize an image, a folder with a new number is created (①) and the resized image is saved in the new folder (②). If you take a picture after resizing the image, another folder with a new number is created (③) and the new image is saved in that folder (④). If you then resize that image, the resized image (⑤) is saved in the resize folder created initially (①).

NEXT 

Resizing an image

- 1** Turn the camera on and press the mode buttons   until "▶" lights up on the mode select LED.

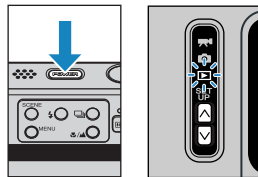

- 2** Press the MENU button  to display the menu icons.

- 3** Move the selector lever left  or right  to select RESIZE  and press .

The resize menu appears.

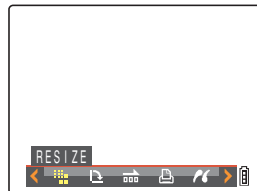

- 4** Move the selector lever up  to select [EXECUTE RESIZING], then press .

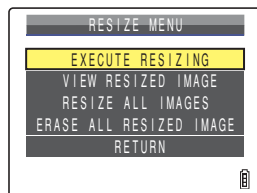





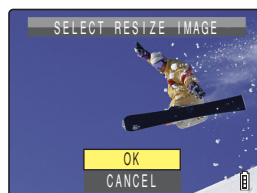

- 5** Move the selector lever left  or right  to select the image to be resized.

- 6** Move the selector lever up  to select [OK], then press .



7 Set the area to be resized and then press .

To simply change the number of pixels, press .

To enlarge an area, press the SCENE button  to enlarge the image by 2x or 4x. Move the selector lever up, down, left and right     to set the area to be resized and then press .

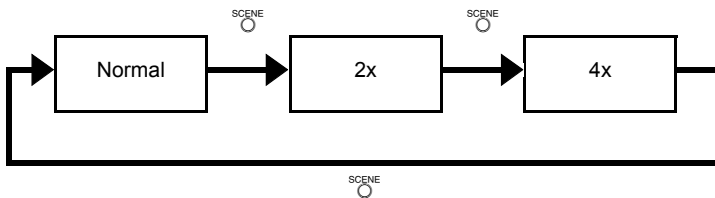

Notes about the desired use are displayed next to each image size.

8 Move the selector lever up or down to select the image size, then press .

The name of the resized image is displayed.

[320x240 E-MAIL(S)] : Resizes the image to a smaller size that is convenient for attaching to an e-mail and sending from a computer.

[160x120 THUMB NAIL]: Resizes the image to a smaller size that is convenient for attaching to an e-mail and sending from a mobile phone.

Note

When you are attaching images to an email to send to a mobile phone, the number of pixels that can be used varies depending on the mobile phone you are using. Refer to the instruction manual for the mobile phone you are using for details.

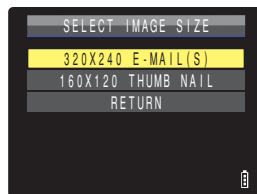
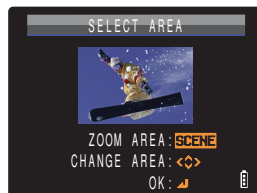
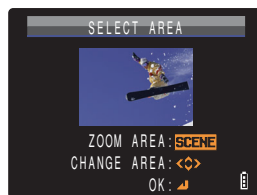

9 Press .



10 Press the MENU button .



Checking and erasing resized images

While you can use normal playback to view resized images, the procedure below enables you to view and erase only the resized images.

- 1 Turn the camera on and press the mode buttons   until "▶" lights up on the mode select LED.

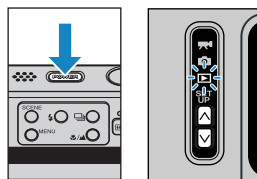

- 2 Press the MENU button  to display the menu icons.

- 3 Move the selector lever left  or right  to select RESIZE  and press .

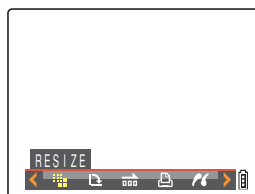

The resize menu appears.







- 4 Move the selector lever up  or down  to select [VIEW RESIZED IMAGE], then press .

The resized images are displayed.

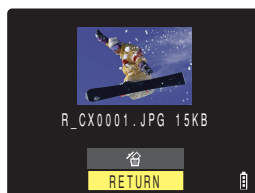
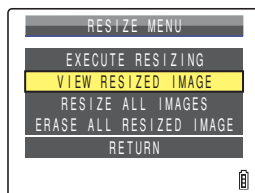
Note

If there are multiple resized images, move the selector lever left  or right  to move between images.



- 5 To erase the image, move the selector lever up  to select [, then press .

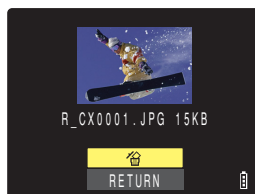

6 Press the MENU button .

Resizing all the images

You can use this procedure to resize all the images recorded on a memory card.

- 1 Turn the camera on and press the mode buttons   until "▶" lights up on the mode select LED.

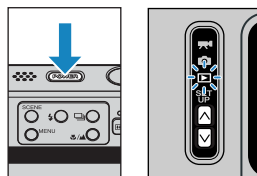

- 2 Press the MENU button  to display the menu icons.

- 3 Move the selector lever left  or right  to select RESIZE  and press .

The resize menu appears.

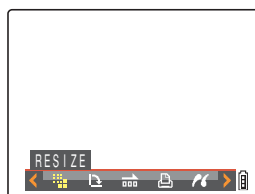

- 4 Move the selector lever up  or down  to select [RESIZE ALL IMAGES], then press .

Notes about the desired use are displayed next to each image size.

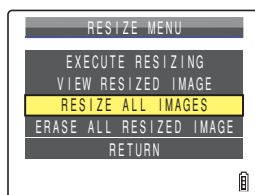

5 Move the selector lever up ▲ or down ▼ to select the image size, then press .

The number of resized images is displayed.

[320x240 E-MAIL(S)] : Resizes the image to a smaller size that is convenient for attaching to an e-mail and sending from a computer.

[160x120 THUMB NAIL]: Resizes the image to a smaller size that is convenient for attaching to an e-mail and sending from a mobile phone.

Note

- When you are attaching images to an email to send to a mobile phone, the number of pixels that can be used varies depending on the mobile phone you are using. Refer to the instruction manual for the mobile phone you are using for details.
- Press the MENU button  during resizing to stop resizing. Only images that have already been resized are saved.

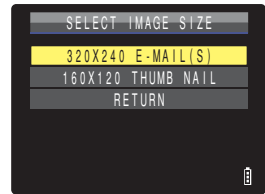

6 Press to confirm.



7 Press the MENU button .

Important

- You may not be able to resize images shot with another camera.
- If the memory card becomes full during resizing of all the images, resizing stops and only the images resized up to that point are saved.
- You cannot resize a specified area (trimming).



Erasing all resized images

This procedure erases all resized images.

- 1 Turn the camera on and press the mode buttons   until "▶" lights up on the mode select LED.

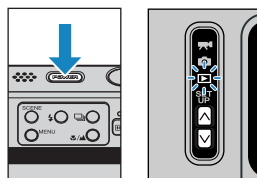

- 2 Press the MENU button  to display the menu icons.

- 3 Move the selector lever left  or right  to select RESIZE  and press .

The resize menu appears.



- 4 Move the selector lever up  or down  to select [ERASE ALL RESIZED IMAGE], then press .

A message appears asking you to confirm that you want to erase all resized images.

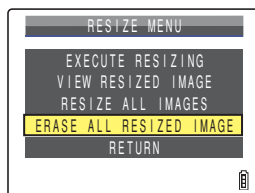

- 5 Move the selector lever up  to select [EXECUTE], then press .

The resized images are all erased.





- 6 Press the MENU button .



[↻] Rotating an Image

«Applicable images: Still images only»

Use the procedure below to rotate an image 90° left or right.

- 1 Turn the camera on and press the mode buttons   until "" lights up on the mode select LED.

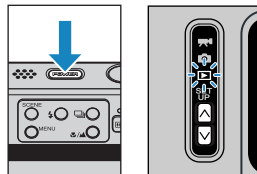

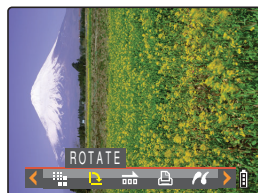

- 2 Press the MENU button  to display the menu icons.

- 3 Move the selector lever left  or right  to select ROTATE  and press .



- 4 Move the selector lever left  or right  to select the image to be rotated.

- 5 Move the selector lever up  or down  to select the direction of rotation, then press .

The rotated image is displayed.

[↶90°] : Rotates the image 90° to the left (counterclockwise)

[90°↷] : Rotates the image 90° to the right (clockwise)

[RETURN]: Returns you to the menu icon screen

 **Note** To rotate another image, repeat steps 4 and 5.

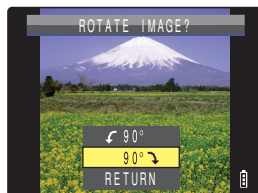
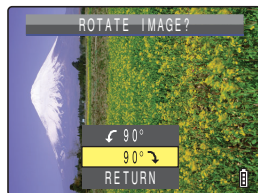

NEXT 

6 Press the MENU button .

! Important

- You cannot rotate groups of continuous shots, protected images or resized images.
- You may not be able to rotate images shot with another camera.
- Images are displayed in the pre-rotated orientation in MULTI playback / GROUP playback modes.



Using DPOF to specify print settings



«Applicable images: Still images only»

DPOF (Digital Print Order Format) is a printing standard for images shot on digital cameras that simplifies the printing of images on a consumer printer or at a print processing outlet.

The DPOF settings specify which images are to be printed and how many copies of each image are printed. They also support other basic settings such as date imprinting. Check that your printer supports DPOF printing or that your local print processing shop provides a DPOF printing service. For more information on the DPOF settings, refer to the instruction manual provided with your DPOF-compatible printer.

 **Note** These settings can also be used in MULTI playback / GROUP playback modes (→ p.90).

Specifying DPOF settings

- 1 Turn the camera on and press the mode buttons   until "" lights up on the mode select LED.

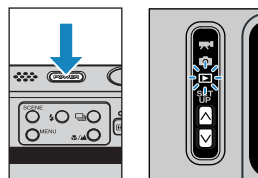

- 2 Press the MENU button  to display the menu icons.

- 3 Move the selector lever left  or right  to select DPOF  and press .

The print settings screen appears.

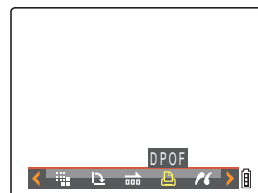

- 4 Move the selector lever up  to select [PRINT], then move the lever right .

The print image selection screen appears.

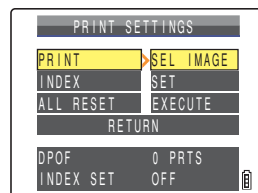

NEXT 

11 Move the selector lever up ▲ or down ▼ to select [PRINT SETS], then move the lever right ►.

The DPOF specifications are set and the print settings screen reappears.

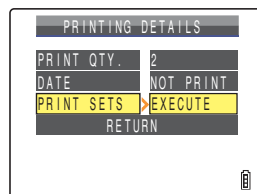

12 Press the MENU button .

! Important

- You may not be able to specify settings if there is too little space available on the memory card.
- You cannot specify settings for resized images.
- You may not be able to configure settings for images shot with another camera.

Note

- To specify DPOF settings for another image, repeat steps 4-11.
- Selecting [RETURN] cancels the settings selected up to step 11 and returns you to the print settings screen.

Specifying index print settings

This function produces a single index print that shows thumbnail versions of the images recorded on the memory card.

1 Turn the camera on and press the mode buttons until "▶" lights up on the mode select LED.

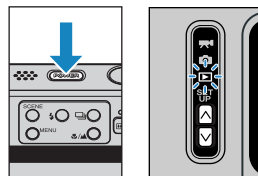

2 Press the MENU button to display the menu icons.

3 Move the selector lever left ◀ or right ▶ to select DPOF and press .

The print settings screen appears.

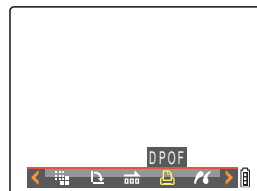

4 Move the selector lever up ▲ or down ▼ to select [INDEX], then move the lever right ►.

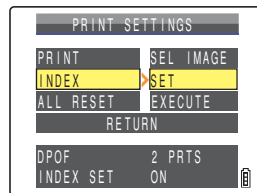

5 Move the selector lever up ▲ to select [SET UP INDEX PRINT] and press ⏻.

Index printing is then set and the print settings screen reappears.



6 Press the MENU button .

Note

- Selecting [ERASE INDEX SETTING] and pressing ⏻ deletes the index print settings and returns you to the print settings screen.
- Select [RETURN] to return to the print settings screen.

Resetting all the DPOF print settings

1 Turn the camera on and press the mode buttons until "▶" lights up on the mode select LED.

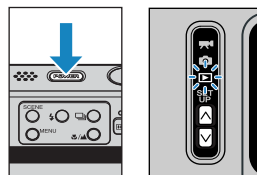

2 Press the MENU button to display the menu icons.

3 Move the selector lever left ◀ or right ▶ to select DPOF and press ⏻.

The print settings screen appears.

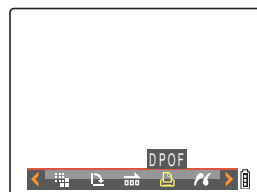

- 4** Move the selector lever up ▲ or down ▼ to select **[ALL RESET]**, then move the lever right ►.

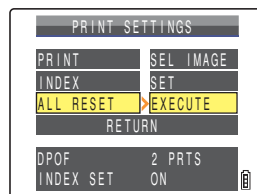

- 5** Move the selector lever up ▲ to select **[EXECUTE]**, then press .

All the print settings are reset and the screen from step 4 reappears.

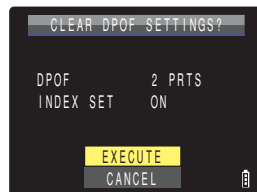

- 6** Press the MENU button .

[📷] Printing by Connecting the Camera Directly to a Printer (PictBridge)

«Applicable images: Still images only»

By connecting the camera to a printer that supports PictBridge, you can print your images quickly and simply direct from the camera. You can also use this method to print images with DPOF settings (→ [p.123](#)) on printers that support DPOF. Refer to the Instruction Manual for your printer when using this print method.

- ❗ **Important**
- Check that your printer supports PictBridge.
 - Set the printer up for printing before starting this procedure. (Refer to the instruction manual for your printer.)

📝 **Note** These settings can also be used in MULTI playback / GROUP playback modes (→ [p.90](#)).

Connecting the camera to the printer

1 Turn the printer on.

2 Place the camera in the USB cradle.

- 📝 **Note** Refer to "Using the USB Cradle" (→ [p.36](#)) for details on attaching the USB cradle.

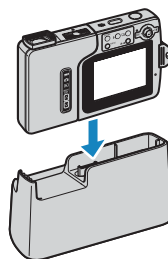

3 Turn the camera on and press the mode buttons   until "▶" lights up on the mode select LED.

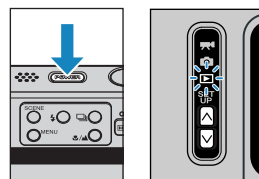

4 Press the MENU button  to display the menu icons.

NEXT 

5 Move the selector lever left ◀ or right ▶ to select PictBridge [P] and press ⏴.

The printer connection screen appears.

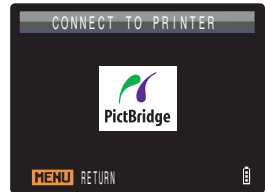
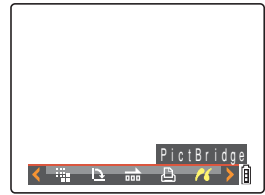

6 Use the USB cable supplied with the camera to connect the USB cradle holding the camera to the printer.

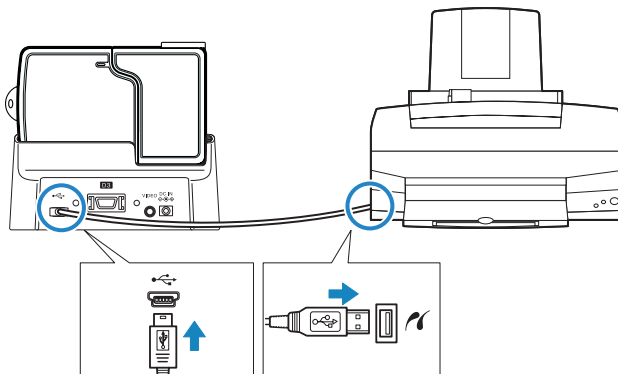

! Important

- Do not connect the camera to the printer until the "CONNECT TO PRINTER" screen shown in step 5 appears on the screen. If you connect to the printer before this screen appears, the camera will enter PC mode and you will not be able to print.
- Check the sizes of the USB connectors. Plug the small connector into the USB cradle and the large connector into the USB port on your printer.



The print menu screen appears.

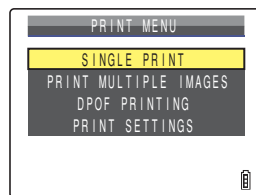

Specifying the print settings

- 1** In the print menu screen, move the selector lever down ▼ to select [PRINT SETTINGS] and then press ⏏.
- 2** Move the selector lever up ▲ to select [PRINT QTY.], then move the lever right ▶.
- 3** Move the selector lever up ▲ or down ▼ to select the number of prints, then press ⏏.

The number of prints is set.

Note The number of prints can be set to a maximum of 9.
- 4** Move the selector lever up ▲ or down ▼ to select [PAPER SIZE], then move the lever right ▶.

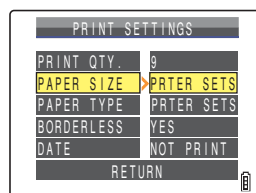
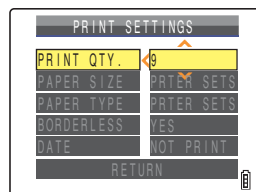
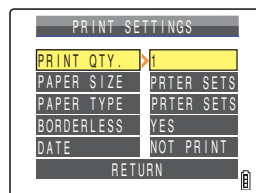
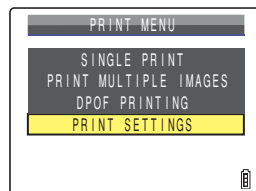

5 Move the selector lever up ▲ or down ▼ to select the paper size, then press .

The paper size is set.

Note

The paper sizes displayed are determined by the printer settings or by the paper sizes supported by the printer.

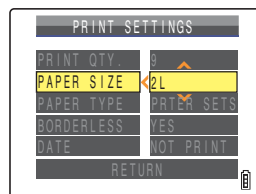

6 Move the selector lever up ▲ or down ▼ to select [PAPER TYPE], then move the lever right ►.

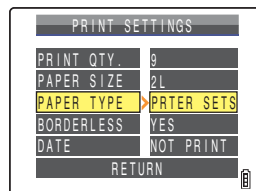

7 Move the selector lever up ▲ or down ▼ to select the paper type, then press .

The paper type is set.

Note

The paper types displayed are determined by the printer settings or by the paper types supported by the printer.

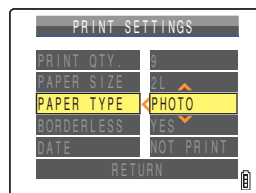

8 Move the selector lever up ▲ or down ▼ to select [BORDERLESS], then move the lever right ►.

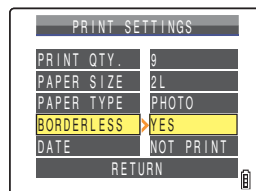

9 Move the selector lever up ▲ or down ▼ to select the desired printing style, then press .

[PRTER SETS] : Uses the printer settings.

[YES] : The images are printed without borders.

[NO] : The images are printed with borders.

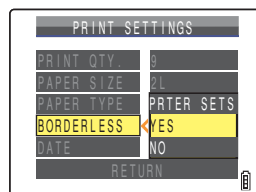

- 10** Move the selector lever up ▲ or down ▼ to select [DATE], then move the lever right ►.

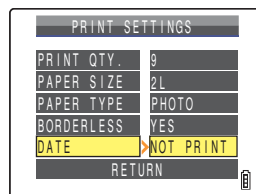

- 11** Move the selector lever up ▲ or down ▼ to select the desired printing style, then press ⏎.

[PRTER SETS] : Uses the printer settings.

[NOT PRINT] : The date is not imprinted on the images.

[PRINT] : The date is imprinted on the images.

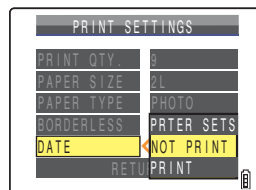

- 12** Move the selector lever down ▼ to select [RETURN], then press ⏎.

Return to the Print Menu screen.

Note If you configured the print settings from the print confirmation screen, return to the print confirmation screen.

Printing individual images

- 1** In the print menu screen, move the selector lever up ▲ to select [SINGLE PRINT] and then press ⏎.

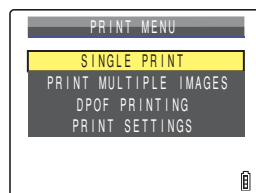

- 2** Move the selector lever left ◀ or right ▶ to select the image to be printed.

- 3** Move the selector lever up ▲ to select [OK], then press ⏎.

A message appears asking you to confirm that you want to print the images.

To change print settings, see "[Specifying the print settings](#)" (→ p.130).

Note Press the MENU button  to display the print menu screen.

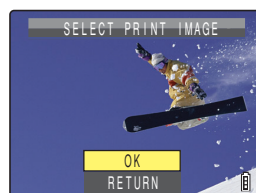



4 Move the selector lever up ▲ to select [EXECUTE], then press ⏻.

Printing begins, and when printing is successfully completed, the print completion screen appears.

! Important If an error occurs during printing, an error message is displayed and printing stops. Refer to [p.190](#) for information on the message displayed and the correct response.

Note

- You can specify the print settings by clicking the SCENE button  before proceeding with this step. (See steps 2 to 12 on [p.130](#) for information on the setting procedure.)
- During printing, a counter on the LCD monitor displays the total number of prints and the number of prints completed so far.
- Press the MENU button  to stop printing in progress.

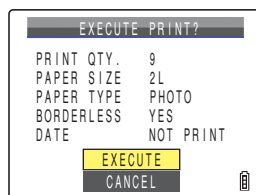



Printing multiple images

1 In the print menu screen, move the selector lever up ▲ or down ▼ to select [PRINT MULTIPLE IMAGES] and then press ⏻.

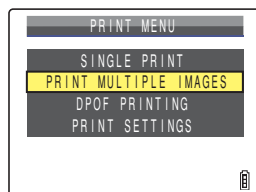
The print image selection screen appears.



2 Move the selector lever up, down, left or right ▲▼◀▶ to select an image you want to print, then press ⏻.

The  icon appears next to the selected images. Repeat this step to select the rest of the images you want to print. To deselect a selected image, select an image marked with the Print icon  and press ⏻.

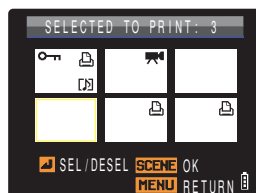

 Note You can select up to 99 images.



3 Press the SCENE button .

A message appears asking you to confirm that you want to print the images.

To change print settings, see "[Specifying the print settings](#)" (→ [p.130](#)).

 **Note** Press the MENU button  to display the print menu screen.

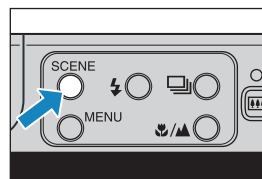



4 Move the selector lever up to select [EXECUTE], then press .

Printing begins, and when printing is successfully completed, the print completion screen appears.

 **Important** If an error occurs during printing, an error message is displayed and printing stops. See [p.190](#) for information on the message displayed and the correct response.

 **Note**

- You can specify the print settings by clicking the SCENE button  before proceeding with this step. (See steps 2 to 12 on [p.130](#) for information on the setting procedure.)
- During printing, a counter on the LCD monitor displays the total number of prints and the number of prints completed so far.
- Press the MENU button  to stop printing in progress.

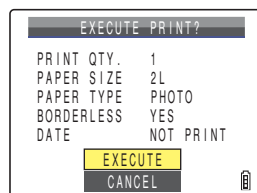

Printing using DPOF settings

 **Important** DPOF printing can only be used if DPOF settings have already been specified for the images. (→ [p.123](#))

1 In the print menu screen, move the selector lever up or down to select [DPOF PRINTING] and then press .

The DPOF print screen appears.

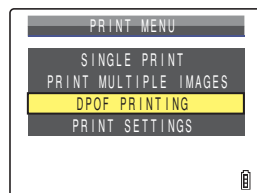

2 Move the selector lever up ▲ to select [EXECUTE], then press .

A message appears asking you to confirm that you want to print the images.

Refer to "[Specifying the print settings](#)" (→ [p.130](#)) to change print settings.

Note

Press the MENU button  to display the print menu screen.





3 Move the selector lever up ▲ to select [EXECUTE], then press .

Printing begins, and when printing is successfully completed, the print completion screen appears.

Important

If an error occurs during printing, an error message is displayed and printing stops. Refer to [p.190](#) for information on the message displayed and the correct response.

Note

- You can specify the print settings by clicking the SCENE button  before proceeding with this step. (See steps 2 to 12 on [p.130](#) for information on the setting procedure.)
- The number of copies and date imprinting settings are not shown because the DPOF settings take precedence.
- During printing, a counter on the LCD monitor displays the total number of prints and the number of prints completed so far.
- Press the MENU button  to stop printing in progress.

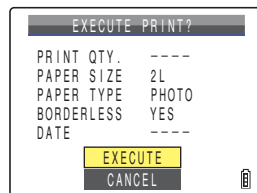

Ending PictBridge

Wait until the print menu screen is displayed, then disconnect the USB cable.



Connecting to a Windows PC

You can view images you have shot with this camera on a PC, copy the images to the PC and edit them, and then send them from the PC via e-mail. First check the operating system software on your PC and then read the relevant sections for your software.

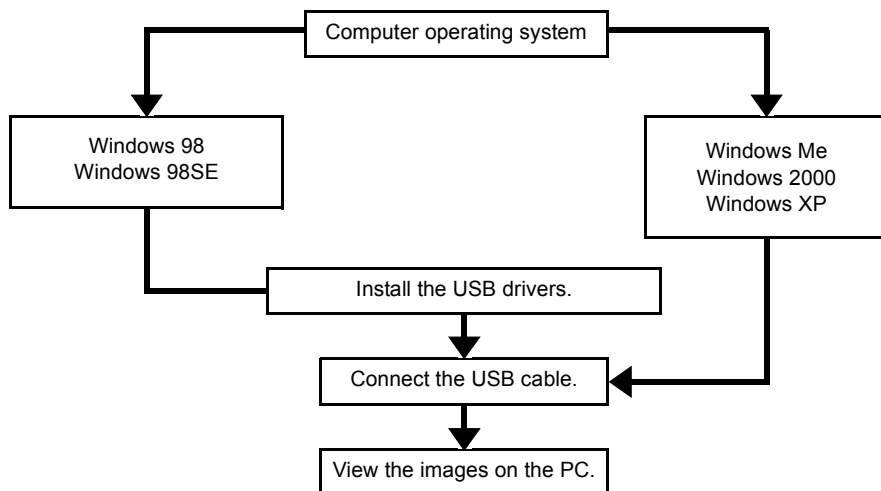

Computer hardware and software requirements

- Must be equipped with a USB port as standard (required for camera connection)
 - Must be equipped with a CD-ROM drive for Windows 98 and Windows 98SE (required for installing the USB drivers)
 - Must have Windows 98, Windows 98SE, Windows Me, Windows 2000 Professional, Windows XP Home Edition or Windows XP Professional pre-installed
- * Successful operation is not guaranteed on systems where the software has been upgraded to the versions listed above.
- * This product supports USB2.0 (Hi-Speed).
By connecting this product to a personal computer that supports Hi-Speed, data can be exchanged at a faster rate.

NEXT 

Install the USB driver (Windows 98, Windows 98SE Only)

If you are using Windows 98 or Windows 98SE, you will need to install the USB drivers. A USB driver is included on the CD-ROM ("Instruction Manual" and USB driver) supplied with the camera.

! Important Do not connect the USB cable until the USB driver installation is complete. Connecting the USB cable prior to installation will prevent successful USB driver installation. If you have mistakenly connected the USB cable, see "[Deleting the Device \(Windows 98 and Windows 98SE only\)](#)" (→ [p.144](#)).

1 Turn the PC on and start up Windows.

2 Insert the CD-ROM provided ("Instruction Manual" and USB driver) into the CD-ROM drive in your PC.

The program on the CD-ROM automatically starts up. If the program does not start automatically, double-click the [CONTAXU4R] icon in [My Computer].

3 When the language selection screen appears, click the language to be used.

4 Click [Install USB drivers].

Installation begins. Proceed with the installation as directed by the on-screen instructions.

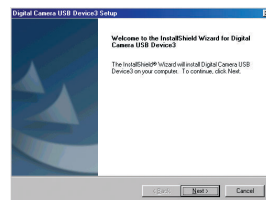

5 When the [InstallShield Wizard Complete] message appears, make sure that the [Yes, I want to restart my computer now.] option is checked, then click [Finish].

Installation ends and the PC restarts.

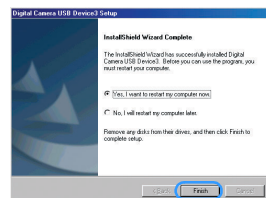

! Important If installation fails, uninstall the drivers as described in "[Deleting the Device \(Windows 98 and Windows 98SE only\)](#)" (→ [p.144](#)) and then install the drivers again.



If you no longer need the USB drivers

- 1 Turn the PC on and start up Windows.
- 2 Double-click [My Computer].
- 3 Double-click [Control Panel].
- 4 Double-click [Add/Remove Programs] and select [Digital Camera USB Device3].
- 5 Click [Add/Remove].

When the [Do you want to completely remove the selected application and all of its components?] message appears, click [OK]. This deletes the drivers.



Viewing images on a Windows PC

- ! Important**
- If you are using Windows 98 or Windows 98SE, install the USB drivers before connecting the USB cable. (→ [p.137](#))
 - If you are using Windows Me, Windows 2000 or Windows XP, you do not need to install the USB drivers. Connect the USB cable without installing the drivers.
 - To view images on your PC, you must have image-viewing software already installed. (To play movies, QuickTime 4.1 or later is required.)
 - Always use the AC adapter when you connect the camera to a computer to view and copy images, etc. If the battery runs out and the camera turns off, files may be corrupted.

1 Insert the memory card into the camera. (→ [p.30](#))

- ! Important** You cannot view images on the PC unless there is a memory card in the camera.

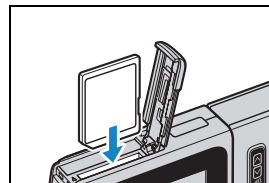

2 Place the camera in the USB cradle and connect the AC adapter.

- Note** Refer to "[Using the USB Cradle](#)" (→ [p.36](#)) for details on attaching the USB cradle.

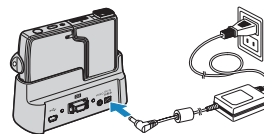

3 Use the USB cable supplied with the camera to connect the USB cradle holding the camera to the PC, then start the PC.

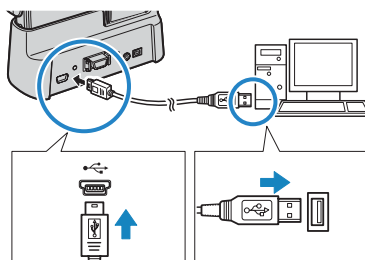

- ! Important** Check the sizes of the USB connectors. Plug the small connector into the USB cradle and the large connector into the USB port on your PC.



4 Press the **POWER** button to turn the camera on.

[PC MODE] appears on the LCD monitor and you can check the images stored on the camera's memory card from your PC and copy the images to your PC.

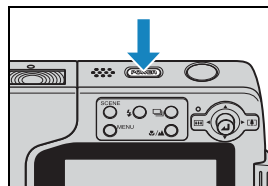

! Important

- In Windows XP, the Scanner and Camera Wizard window may appear. If this happens, click the Cancel button to close the window.
- When the camera is connected to a PC and you are viewing or copying images, the card access LED flashes. Do not do any of the following:
 - Remove the camera from the USB cradle.
 - Unplug the USB cable.
 - Turn off the PC.

📄 Note

- When the camera is connected to the PC and the two are communicating so that files can be exchanged, the self-timer LED lights.
- The procedure for disconnecting the USB cable once the camera and PC have established communication differs according to the version of Windows you are using. (→ [p.142](#))

5 A [Removable Disk] icon appears in the [My Computer] window. Double-click the icon to open the disk window.

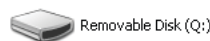

! Important

If [PC MODE] is displayed on the LCD monitor but no [Removable Disk] icon appears in the [My Computer] window on the PC, check that the USB cable is securely connected.

6 Open the [xxxCXBOX] folder or the [xxxCXRSZ] resized images folder in the DCIM folder and then select and double-click the image file you want to view.

📄 Note

A number between 100 and 999 is substituted for "xxx" in the [xxxCXBOX] and [xxxCXRSZ] folder names. (→ [p.182](#))



■ Memory card folder structure

On Windows PCs, the folders in a camera memory card are configured as shown below.

Removable Disk

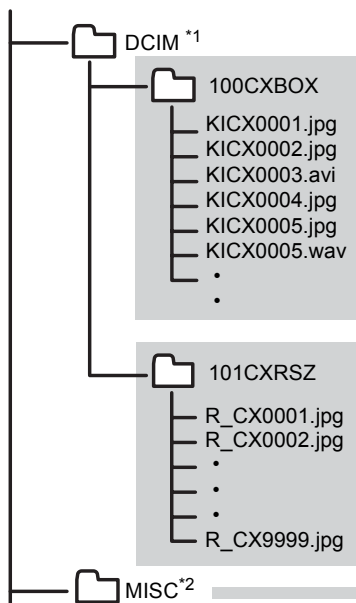

Still Image / Movie / Audio

The same file name cannot be used twice in the same folder.

If one of the images is erased on the camera, that file name is skipped.

Audio data recorded using the postrecording feature is saved in the same folder as the still image, but with the file extension changed to ".wav".

Resized images are recorded here.

This folder is created when DPOF print settings are specified (→ [p.123](#)).

^{*1} DCIM: Digital Camera Image

^{*2} MISC: Miscellaneous

! Important

- Do not delete image files from a memory card using your PC. Always use the camera to erase images.
- The same file name cannot be used twice in the same folder. If one of the images is erased on the camera, that file name is skipped.
- If you use the Suspend-Resume function or wake your PC up from sleep mode, it may not be possible to resume communication.
- When you want to edit an image (resizing, rotating, etc.), do not forget to copy the image to your PC beforehand. If you directly edit the image on the memory card, the image will no longer be viewable in the camera.
- Do not format the memory card using your PC. This may make the memory card unusable in the camera.

← BACK

NEXT →

Disconnecting the USB cable from a Windows PC

Use the procedure below when disconnecting the USB cable from a Windows PC.

● For Windows Me users

- 1 Double-click the [Unplug or Eject Hardware] icon in the task bar in the lower-right corner of the desktop.
- 2 Select [USB Disk] and then click [Stop].
- 3 Select [USB Disk] and then click [OK].
- 4 When the message saying [The 'USB Disk' device can now be safely removed from the system] appears, click [OK].
- 5 Disconnect the USB cable from the PC and the USB cradle.

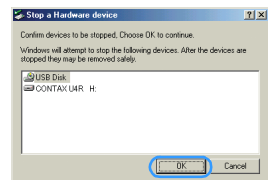
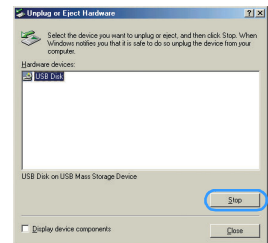
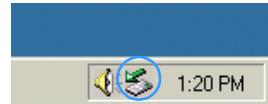

• For Windows 2000, Windows XP users

- 1 Double-click the [Unplug or Eject Hardware] icon in the task bar in the lower-right corner of the desktop.**
- 2 Select [USB Mass Storage Device] and then click [Stop].**

- 3 Select [CONTAX U4R USB Device] and then click [OK].**

- 4 When the message saying [The 'USB Mass Storage Device' device can now be safely removed from the system] appears, click [OK].**

- 5 Disconnect the USB cable from the PC and the USB cradle.**

• For Windows 98, Windows 98SE users

Turn off the camera and then simply disconnect the USB cable.

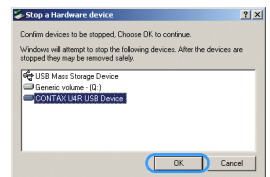
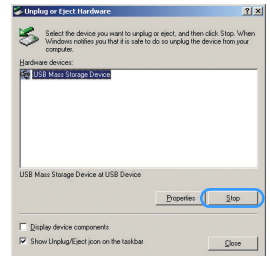

Deleting the Device (Windows 98 and Windows 98SE only)

If the driver software is not installed successfully, the PC will be unable to recognize the camera.

If this occurs, use the procedure below to delete the device. Then use the procedure on [p.137](#) to re-install the drivers.

*Note that this operation is only required for Windows 98 and Windows 98SE.

1 Insert the memory card into the camera. (→ [p.30](#))

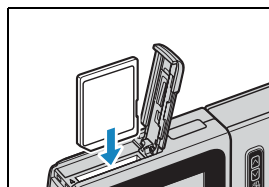

2 Place the camera in the USB cradle and connect the AC adapter.



Note

Refer to "[Using the USB Cradle](#)" (→ [p.36](#)) for details on attaching the USB cradle.

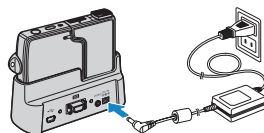

3 Use the USB cable supplied with the camera to connect the USB cradle holding the camera to the PC, then start the PC.

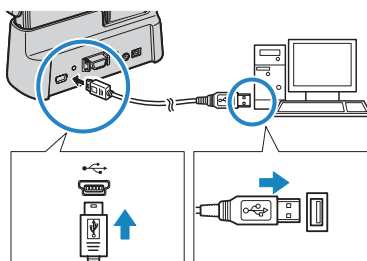

! Important

Check the sizes of the USB connectors. Plug the small connector into the USB cradle and the large connector into the USB port on your PC.

4 Press the **POWER** button  to turn the camera on.

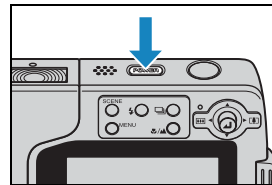

5 Right-click [My Computer] and select [Properties].

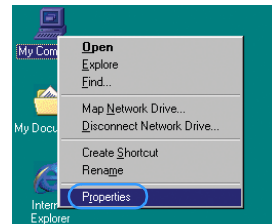

6 When the [System Properties] window opens, click the [Device Manager] tab.

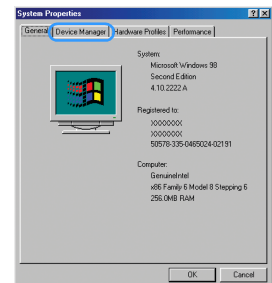

7 Select [CONTAX U4R] marked with a question mark in [Other devices] and then click [Remove].

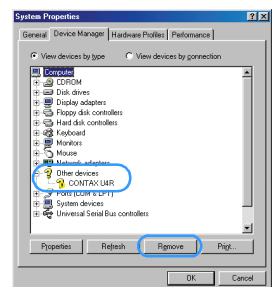

8 When the device deletion confirmation message appears, click [OK].

9 Turn the camera off, disconnect the **USB** cable and then restart your **PC**.



Connecting to a Macintosh

You can view images you have shot with this camera on a Macintosh, copy the images to the Macintosh and edit them, and then send them from the Macintosh via e-mail.

First check the operating system software on your Macintosh and then read the relevant sections for your software.

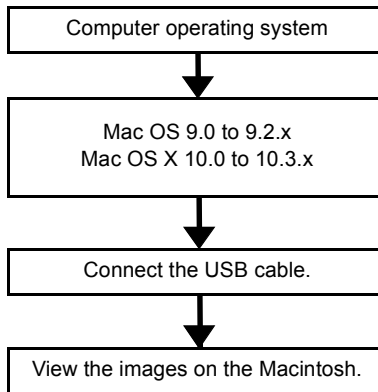

Computer hardware and software requirements

- Must be equipped with a USB port as standard (required for camera connection)
- Must have Mac OS 9.0 to 9.2.x or Mac OS X 10.0 to 10.3.x (excluding OS X Server) pre-installed

*Successful operation is not guaranteed on systems where the software has been upgraded to the versions listed above.

Viewing images on a Macintosh

- ! **Important**
- You do not need to install the USB drivers on a Macintosh computer. Connect the USB cable without installing the drivers.
 - To view images on your Macintosh, you must have image-viewing software already installed. (To play movies, QuickTime 4.1 or later is required.)
 - Always use the AC adapter when you connect the camera to a computer to view and copy images, etc. If the battery runs out and the camera turns off, files may be corrupted.

1 Insert the memory card into the camera. (→ [p.30](#))

- ! **Important** You cannot view images on the Macintosh unless there is a memory card in the camera.

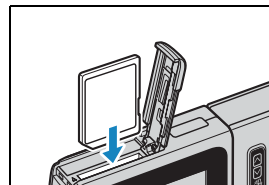

2 Place the camera in the USB cradle and connect the AC adapter.

- 📄 **Note** Refer to "Using the USB Cradle" (→ [p.36](#)) for details on attaching the USB cradle.

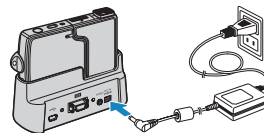

3 Use the USB cable supplied with the camera to connect the USB cradle to the Macintosh and start the Macintosh.

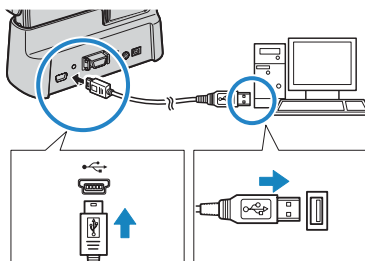

- ! **Important** Check the sizes of the USB connectors. Plug the small connector into the USB cradle and the large connector into the USB port on your Macintosh.



4 Press the **POWER** button to turn the camera on.

[PC MODE] appears on the LCD monitor and you can check the images stored on the camera's memory card from your Macintosh and copy the images to your Macintosh.

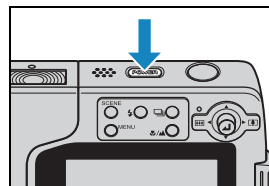

! Important When the camera is connected to a Macintosh and you are viewing or copying images, the card access LED flashes. Do not do any of the following:

- Remove the camera from the USB cradle.
- Unplug the USB cable.
- Turn off the Macintosh.

 **Note**

When the camera is connected to the Macintosh and the two are communicating so that files can be exchanged, the self-timer LED lights.

5 An [untitled] disk icon appears on the desktop. Double-click the icon to open the disk window.

* Displayed as [NO_NAME] in Mac OS X 10.0 to 10.3.x.

! Important If [PC MODE] is displayed on the LCD monitor but no [untitled] or [NO_NAME] icon appears, check that the USB cable is securely connected.

6 Open the [xxxCXBOX] folder or the [xxxCXRSZ] resized images folder in the DCIM folder and then select and double-click the image file you want to view.

 **Note**

A number between 100 and 999 is substituted for "xxx" in the [xxxCXBOX] and [xxxCXRSZ] folder names. (→ [p.182](#))



■ Memory card folder structure

On Macintosh computers, the folders in a camera memory card are configured as shown below.

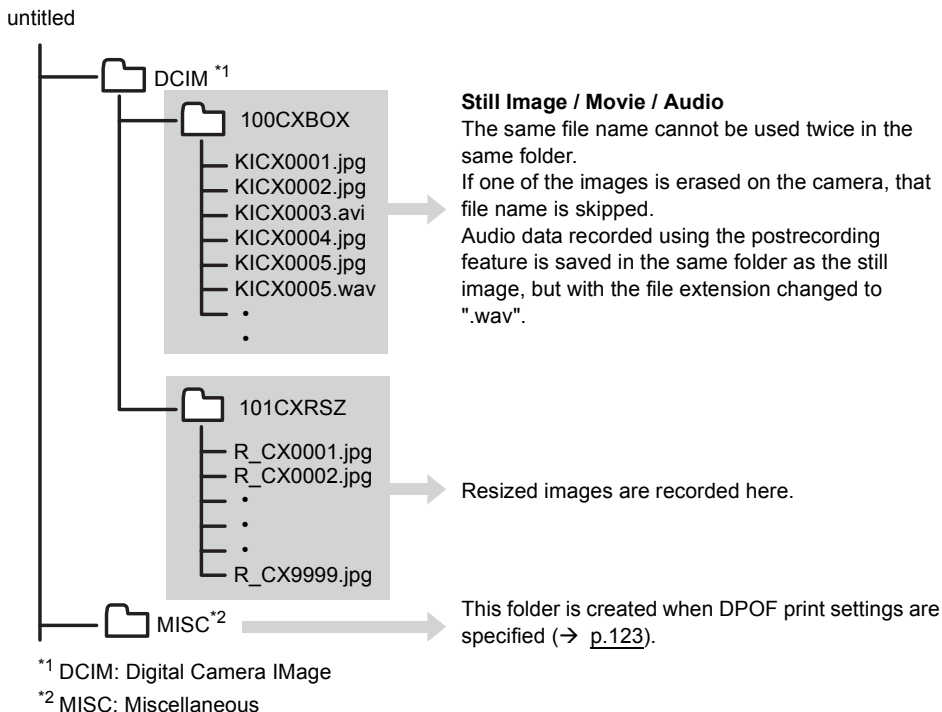

! Important

- Do not delete image files from a memory card using your Macintosh. Always use the camera to erase images.
- The same file name cannot be used twice in the same folder. If one of the images is erased on the camera, that file name is skipped.
- If you use the Energy Saver function and wake your Macintosh up from sleep mode, it may not be possible to resume communication.
- When you want to edit an image (resizing, rotating, etc.), do not forget to copy the image to your Macintosh beforehand. If you directly edit the image on the memory card, the image will no longer be viewable in the camera.
- Do not format the memory card using your Macintosh. This may make the memory card unusable in the camera.

Disconnecting the USB cable from a Macintosh

Drag the [untitled] (Mac OS 9) or [NO_NAME] (Mac OS X) folder on the desktop to the Trash. Check that the "It is now safe to disconnect the device" message is displayed or that the [untitled] (Mac OS 9) or [NO_NAME] (Mac OS X) icon is no longer displayed on the desktop before disconnecting the USB cable.



Connecting to a Television

«Use the VIDEO OUT port to connect to the television»

You can view the images taken with the camera on a television. You can view images you have taken on a television while you are traveling or at your home.

1 Insert the memory card into the camera. (→ p.30)

! Important You cannot view images on the television unless there is a memory card in the camera.

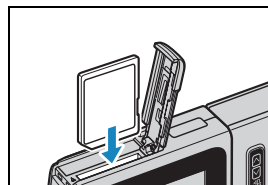

2 Place the camera in the USB cradle and connect the AC adapter.

! Important Turn the camera and television off before connecting them.

Note Refer to "Using the USB Cradle" (→ p.36) for details on attaching the USB cradle.

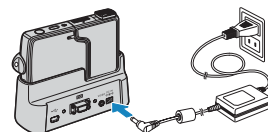

3 Use the supplied video cable to connect the USB cradle holding the camera to the television, then turn the television on.

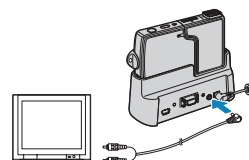

4 Turn the camera on and press the mode buttons until "" lights up on the mode select LED.

Images are displayed on the television.

The shooting, playback and SET UP functions are enabled in this state.

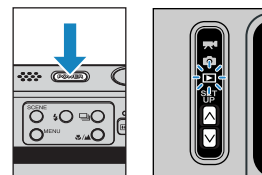

NEXT 

! Important

- Set the television to video input mode.
- The LCD monitor turns off while the video cable is connected.
- Images may sometimes not be displayed correctly on a television.

📝 Note

The video output format of the camera can be selected from NTSC and PAL formats. Because different TV signal formats are used in different countries, when you connect the camera to a television while on vacation, you should set the video output to the format of the country you are in. Refer to [p.179](#) to configure this setting.



«Playback on a television that supports D3 or higher video input»

You can view the pictures taken with the camera on a television that supports D3 or higher video input. You can get clearer images by connecting the television to the D3 video output connector instead of the VIDEO OUT port.

About the D connector

The D connector is a standardized video connector component that supports digital tuners, DVD players, etc. This camera offers 1080 scan line resolution. You can view images on a television by connecting the camera to a D3 or D4 video input port (D3 video is displayed even if the camera is connected to a D4 video input port). You cannot view images on a television using a D1 or D2 video input connector.

- ❗ **Important**
- Connection to a television supporting D3 or higher video input is only available within Japan. This cannot be used in foreign countries.
 - You cannot use shooting or SET UP functions while connected to a television via a D3 or higher video input connector.
 - You cannot playback movies or postrecorded audio while playing back on a television using a D3 or higher video input connector. Only the first frame of movies will be shown.

1 Insert the memory card into the camera. (→ [p.30](#))

- ❗ **Important** You cannot view images on the television unless there is a memory card in the camera.

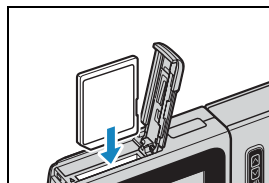

2 Place the camera in the USB cradle and connect the AC adapter.

- ❗ **Important** Turn the camera and television off before connecting them.

- 📄 **Note** Refer to "[Using the USB Cradle](#)" (→ [p.36](#)) for details on attaching the USB cradle.

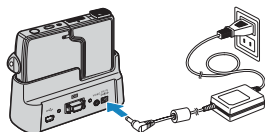

3 Use the D-connector cable to connect the USB cradle holding the camera to the television, then turn the television on.

- ! Important** Push the D3 connector cable on until the clips on the right and left sides of the D3 video connector click into place.

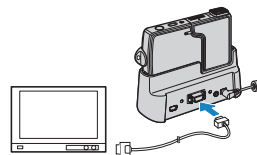

4 Turn the camera on.

Images are displayed on the television.

The table below shows the operations that can be performed during playback.

Operation	Description
Selector lever up ▲	Switches to the File No display. (→ p.24)
Selector lever left ◀	Displays images in reverse order.
Selector lever right ▶	Displays images in forward order.

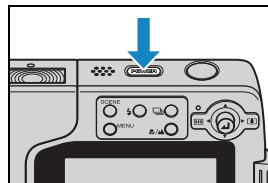

- ! Important**
- The LCD monitor turns off while the D-connector cable is connected.
 - Images may sometimes not be displayed correctly on a television.

Note [🔊] and [🔊] are displayed for movies and still images with postrecorded audio.

Displaying Information (File No Display)

«Applicable images: Still images / movies»

You can check information such as the filename and number of pixels of an image during playback.

1 Move the selector lever up ▲ while playing back an image.

The information for the displayed image appears.

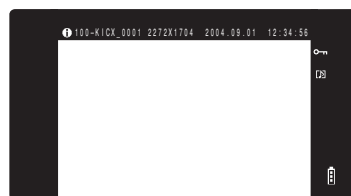

- Note**
- Refer to p.24 for details of the screen displayed.
 - Press the MENU button \bigcirc^{MENU} when information is displayed to return to the normal playback screen.



[↶] Rotating an Image

«Applicable images: Still images only»



Use the procedure below to rotate an image 90° left or right.

1 Press the MENU button  during playback to display the menu icons.

2 Move the selector lever up  to select ROTATE  and press .



3 Move the selector lever left  or right  to select the image to be rotated.

4 Move the selector lever up  or down  to select the direction of rotation, then press .

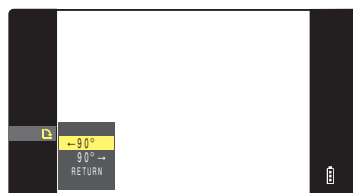

The rotated image is displayed.

[←90°] : Rotates the image 90° to the left (counterclockwise)

[90°→] : Rotates the image 90° to the right (clockwise)

[RETURN]: Returns you to the menu icon screen

 **Note** To rotate another image, repeat steps 3 and 4.

5 Press the MENU button .

- ! Important**
- You cannot rotate protected images or resized images.
 - You may not be able to rotate images shot with another camera.



[] Viewing Images Automatically as a Slideshow (Auto Play)

«Applicable images: Still images / movies»

Images are displayed at fixed intervals in the order that they were shot. You can configure the effect used for the transition between images.

[AUTO PLAY] settings

You can specify the following settings for an [AUTO PLAY] slideshow:

- [INTERVAL] : The delay between images
- [START FRAME] : The first image in the slideshow
- [EFFECT] : The effect used in the transition between images

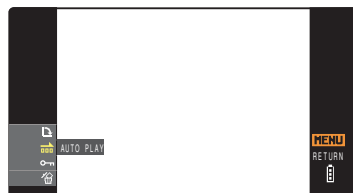

1 Press the MENU button  during playback to display the menu icons.

2 Move the selector lever up  or down  to select AUTO PLAY [] and press .

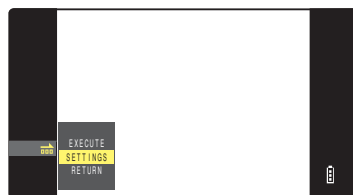

3 Move the selector lever up  or down  to select [SETTINGS] and press .



4 Move the selector lever up  to select [INTERVAL], then move the lever right .

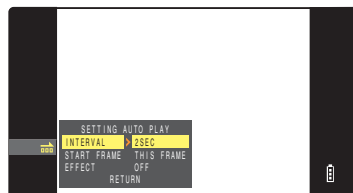

5 Move the selector lever up ▲ or down ▼ to select the desired value, then press ⏵.

The available intervals are 2, 10, 15 and 30 seconds.

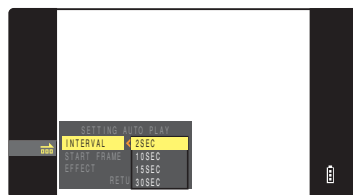

6 Move the selector lever up ▲ or down ▼ to select [START FRAME], then move the lever right ►.

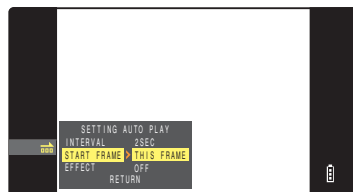

7 Move the selector lever up ▲ or down ▼ to select the starting image, then press ⏵.

[THIS FRAME] : Starts playback from the currently displayed image.

[1ST FRAME] : Starts playback from the image with the lowest number in the file name.

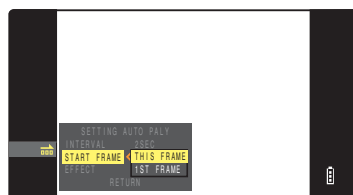

8 Move the selector lever up ▲ or down ▼ to select [EFFECT], then move the lever right ►.

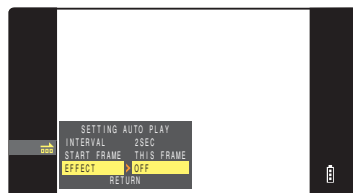

9 Move the selector lever up ▲ or down ▼ to select the desired effect, then press .

- [OFF] : No effect is set.
- [FADE] : The current image gradually darkens (fades out) and the next image gradually fades in.
- [OVERLAP] : The next image slides over the current image and replaces it.
- [SHUTTER] : Black curtains close from the top and bottom of the screen to erase the current image, after which the black curtains open again towards the top and bottom to reveal the next image.
- [WIPE] : The current image disappears as if wiped away from the left and is replaced by the next image.

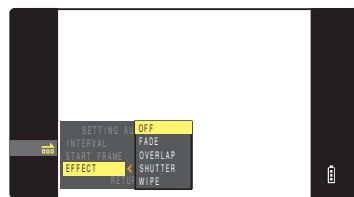

10 Press the MENU button .

Starting and Ending an [AUTO PLAY] Slideshow

See [p.156](#) for more information on the [AUTO PLAY] settings.

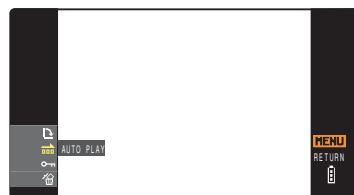

1 Press the MENU button during playback to display the menu icons.

2 Move the selector lever up ▲ or down ▼ to select AUTO PLAY and press .



3 Move the selector lever up ▲ to select [EXECUTE], then press .

The slideshow begins.

-  **Note** Press the MENU button  to end a slide show in progress.

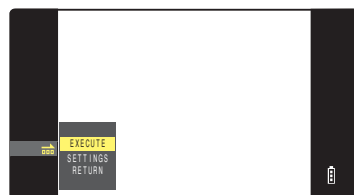

[] Protecting Images from Accidental Erasing (PROTECT)

«Applicable images: Still images / movies»

This feature enables you to protect important images to ensure that they are not inadvertently erased.

Protecting an image

1 Press the MENU button  during playback to display the menu icons.

2 Move the selector lever up  or down  to select PROTECT [] and press .



3 Move the selector lever left  or right  to select the image to be protected.

4 Move the selector lever up  to select [SET], then press .

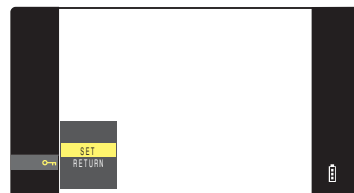

The [] icon appears on protected images.





 **Note** To protect another image, repeat steps 3 and 4.

5 Press the MENU button .

! Important [ERASE ALL] (→ [p.106](#)) does not erase protected images. However, [FORMAT] (→ [p.163](#)) erases all of the images on the card, including protected images.



Unprotecting an image

- 1 Press the MENU button  during playback to display the menu icons.
- 2 Move the selector lever up  or down  to select PROTECT  and press .



- 3 Move the selector lever left  or right  to select the image to be unprotected.

The  icon is displayed with protected images.

- 4 Move the selector lever up  to select [EXECUTE], then press .

The image protection is removed.

 **Note** To unprotect another image, repeat steps 3 and 4.



- 5 Press the MENU button .



[🗑️] Erasing individual images (ERASE)

«Applicable images: Still images / movies»

Use the procedure below to erase a single image.

- ❗ **Important**
- You cannot erase protected images (→ [p.107](#)).
 - When you erase an image with a postrecorded voice message (→ [p.110](#)), the sound file is also erased.

1 Press the MENU button  **during playback to display the menu icons.**

2 Move the selector lever down  **to select ERASE [🗑️] and press** .



3 Move the selector lever left  **or right**  **to select the image you want to erase.**

4 Move the selector lever up  **to select [EXECUTE], then press** .



The image is erased and the next image appears.

If there are no further images, the "NO IMAGE" message appears.

-  **Note** To erase another image, repeat steps 3 and 4.

5 Press the MENU button .



Set Up

This chapter describes how to set up some of the camera's more advanced functions.

▼ **Click on the section you want to read.**

Formatting Memory Card

FORMAT

Adjusting the LCD Monitor Brightness

BRIGHT CNTRL

Adding the Date to Images

INSERT DATE

Setting POWER SAVE

POWER SAVE

Adjusting the BEEP

BEEP

Adjusting the SHUTTER VOLUME

SHUTTER VOL

Setting the Startup Screen

START SCREEN

Checking images right after shooting

REC REVIEW

Selecting the Language

言語LANGUAGE

Setting VIDEO OUTPUT

VIDEO OUT

Selecting the camera mode used at startup

STARTUP MODE

Selecting the Way Image Information is Displayed

DISPLAY INFO

Resetting File Numbers

FILE NO.

Using MODE RESET

MODE RESET

[FORMAT] Initializing a Memory Card

You should use this function to format new memory cards before you use them or when you want to erase all the files (including images) on a card.

- ! **Important**
- To ensure that you get the best possible performance from this camera, cards should be formatted in the camera.
 - Note that formatting a card also erases protected images.

1 Turn the camera on and press the mode button until "SET UP" lights up on the mode select LED.

The SET UP menu screen is displayed.

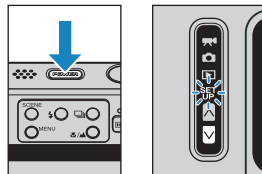

2 Move the selector lever up or down to select [FORMAT], then move the lever right .

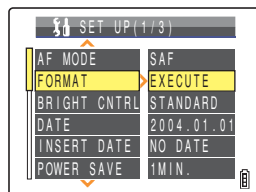

3 Move the selector lever up to select [EXECUTE], then press .

Card formatting begins.

When formatting is completed, the SET UP menu screen reappears.

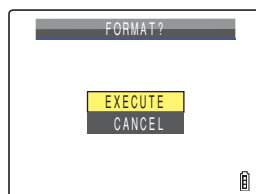

[BRIGHT CNTRL] Adjusting the LCD Monitor Brightness

You can adjust the LCD monitor brightness through 5 levels. Set the brightness to your preferred level.

- 1 Turn the camera on and press the mode button  until "SET UP" lights up on the mode select LED.

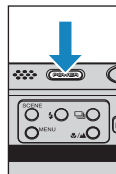

- 2 Move the selector lever up  or down  to select [BRIGHT CNTRL], then move the lever right .

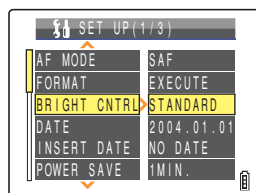

- 3 Move the selector lever up  or down  to select the brightness, then press .

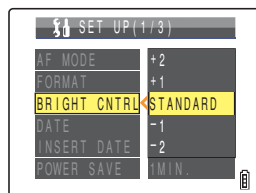

The selected brightness is applied.

- [+2] : Sets the maximum brightness.
- [+1] : Sets the brightness slightly higher than normal.
- [STANDARD] : Normal level of brightness. (Default)
- [-1] : Sets the brightness slightly lower than normal.
- [-2] : Sets the minimum brightness.



Note

This setting is retained when you turn the camera off.

[INSERT DATE] Adding the Date to Images

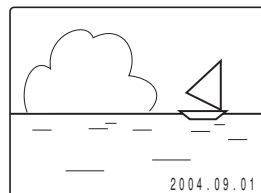

You can choose to imprint the date on images.

1 Turn the camera on and press the mode button  until "SET UP" lights up on the mode select LED.

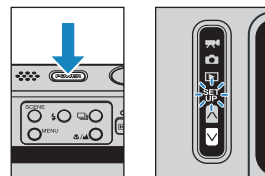

2 Move the selector lever up  or down  to select [INSERT DATE], then move the lever right .



3 Move the selector lever up  or down  to select [NO DATE] or [WITH DATE], then press .

The selected setting is applied.

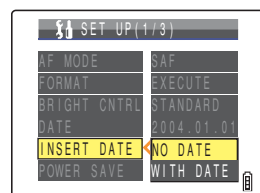
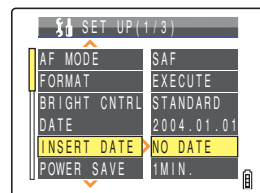

! Important If you set [DATE] to [PRINT] in [DPOF] (→ p.123), then print photographs that were shot with [INSERT DATE] set to [WITH DATE], the date will appear twice on the prints.

Note

- This setting is retained when you turn the camera off.
- When [INSERT DATE] is set to [NO DATE], the date is only shown for 3 seconds when the camera is turned on.
- The date is written on the bottom right of the image. It is not possible to erase the date from an image.
- The date may be difficult to read if the background in the section where the date is written is bright white or yellow.

[POWER SAVE] Having the Camera Turn Off Automatically to Save Power

Forgetting to turn the camera off can cause the camera's battery charge to fall to a low level. For this reason, the camera features a power save function that automatically turns the camera off after several minutes if it is left turned on. When you activate the power save function, the camera automatically enters sleep mode after the configured time and then turns off two minutes later. In sleep mode, the LCD monitor goes blank. This setting allows you to choose the amount of time before the camera enters sleep mode.

1 Turn the camera on and press the mode button  until "SET UP" lights up on the mode select LED.

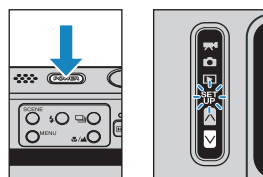

2 Move the selector lever up  or down  to select [POWER SAVE], then move the lever right .

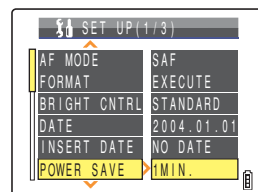

 NEXT

3 Move the selector lever up ▲ or down ▼ to select the desired time, then press .

The selected setting is applied.

[NO PWR OFF]: The camera is not automatically turned off. Take care to remember to turn the camera off yourself.

[15SEC] : In "📷" and "📺" mode, the LCD monitor turns off after 15 seconds. In "📷" and "SET" mode, the camera shuts down after 1 minute.

[30SEC] : In "📷" and "📺" mode, the LCD monitor turns off after 30 seconds. In "📷" and "SET" mode, the camera shuts down after 1 minute.

[1MIN.] : In "📷" and "📺" mode, the LCD monitor turns off after 1 minute. In "📷" and "SET" mode, the camera shuts down after 1 minute. (Default)

[3MIN.] : In "📷" and "📺" mode, the LCD monitor turns off after 3 minutes. In "📷" and "SET" mode, the camera shuts down after 3 minutes.

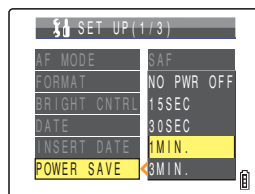

! Important

The power save function does not operate in the following situations:

- During a slideshow
- While shooting or playing back a movie
- While playing back continuous shots
- In PC mode (while connected to a computer)
- When connected to a PictBridge-compatible printer

Note

This setting is retained when you turn the camera off.



■ Notes on using the power save function (in "D" or "A" mode)

Depending on the power save setting, the camera operates as follows:

- When [POWER SAVE] is set to [15SEC], [30SEC], [1MIN.] or [3MIN.].

If the camera is left turned on for the configured time or longer, the LCD monitor automatically goes blank for two minutes (sleep mode).

While the camera is in sleep mode, it can be quickly returned to its original shooting mode by pressing the shutter release button half way or by pressing any of the other function buttons.

However, the camera turns off after the two minutes have passed.

- When [POWER SAVE] is set to [NO PWR OFF].

If the camera is left turned on for six minutes or more, the LCD monitor goes blank.

In this case, the LCD monitor remains blank but the camera is not turned off. To return the camera to its normal shooting mode, press the shutter release button half way or press any of the other function buttons.

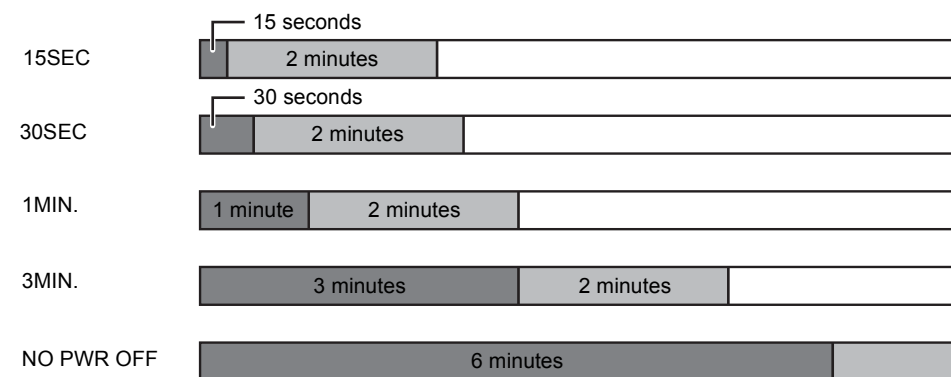

 : Shooting mode

 : Sleep mode (LCD monitor blank). Pressing the shutter release button half way or pressing any of the other function buttons returns the camera to shooting mode. (Sleep mode)

 : Camera turned off





[BEEP] Adjusting the Volume of the Camera Button Beep

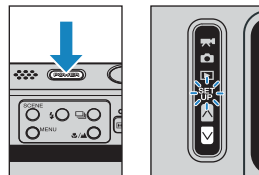

Use this procedure to adjust the volume of the beep emitted when a camera button is pressed or the camera is turned on.

- 1 Turn the camera on and press the mode button  until "SET UP" lights up on the mode select LED.

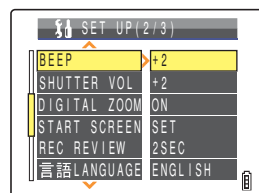

- 2 Move the selector lever up  or down  to select [BEEP], then move the lever right .



- 3 Move the selector lever up  or down  to select the desired volume, then press .

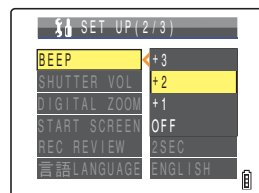

The selected volume is applied.

- [+3] : Maximum volume
- [+2] : Medium volume (Default)
- [+1] : Low volume
- [OFF] : No button beep

 **Note** This setting is retained when you turn the camera off.

[SHUTTER VOL] Adjusting the Volume of the Shutter Sound

Use this procedure to adjust the volume of the shutter sound.

- 1 Turn the camera on and press the mode button  until "SET UP" lights up on the mode select LED.

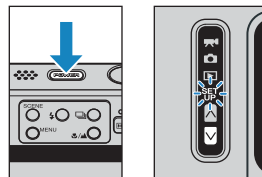

- 2 Move the selector lever up  or down  to select [SHUTTER VOL], then move the lever right .

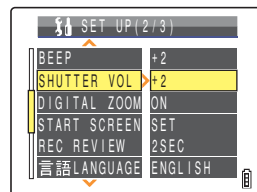

- 3 Move the selector lever up  or down  to select the desired volume, then press .

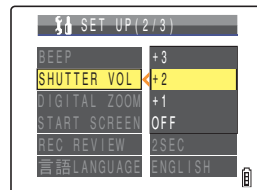

The selected volume is applied.

- [+3] : Maximum volume
- [+2] : Medium volume (Default)
- [+1] : Low volume
- [OFF] : No shutter sound

 **Note** This setting is retained when you turn the camera off.

[START SCREEN] Selecting the Startup Screen

Use this procedure to select one of the following as the startup screen that is displayed when you turn the camera on:

- CONTAX logo (SINGLE) : The CONTAX logo screen is displayed for approximately 1 second. (Default)
- CONTAX logo (MULTI) : The CONTAX logo animation is displayed for approximately 1 second.
- User-defined screen (SINGLE) : You can choose an image from those saved on the memory card to display for approximately 1 second.
- User-defined screen (MULTI) : You can choose multiple images from the memory card to display sequentially for approximately 1 second to form an animation. (up to 10 images)
- OFF screen : No startup screen is displayed.

Note

When you turn the power on, the camera runs a check on the memory card. If there is a lot of data stored on the memory card, the startup screen is displayed until the check operation is finished. If the startup screen is set to MULTI, the final frame of the animation is displayed during this time.

To set the CONTAX logo screen (SINGLE/MULTI)

1 Turn the camera on and press the mode button  until "SET UP" lights up on the mode select LED.

The SET UP menu screen is displayed.

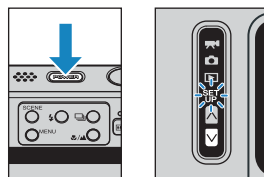

2 Move the selector lever up  or down  to select [START SCREEN], then move the lever right .

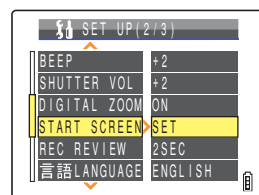

NEXT 

- 3 Move the selector lever up ▲ or down ▼ to select [SINGLE] or [MULTI], then press .**

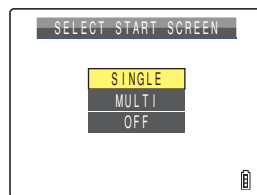

- 4 Move the selector lever left ◀ to select the CONTAX logo screen, then press .**

The CONTAX logo screen is configured, and an example of the startup screen is displayed for 1 second before returning to the SET UP menu screen.

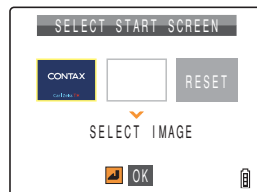

 **Note** This setting is retained when you turn the camera off.

To set a user-defined screen (SINGLE)

- ! Important** Check that the memory card containing the images you want to use is inserted into the camera.

- 1 Turn the camera on and press the mode button  until "SET UP" lights up on the mode select LED.**

The SET UP menu screen is displayed.

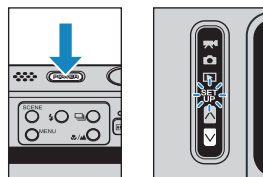

- 2 Move the selector lever up ▲ or down ▼ to select [START SCREEN], then move the lever right ▶.**

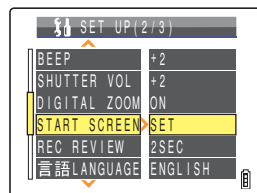

3 Move the selector lever up ▲ to select [SINGLE], then press ⏪.

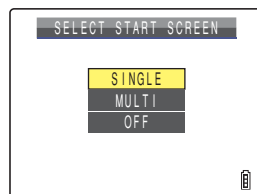

4 Move the selector lever left ◀ or right ▶ to select the center location, then move the lever down ▼.

The image selection screen appears showing the still images stored on the memory card.

Note

If you select [RESET], the reset confirmation message appears. Select [EXECUTE] and press ⏪ to delete the user-defined screen set previously from the camera's memory.

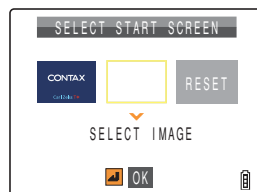

5 Move the selector lever left ◀ or right ▶ to select an image and press ⏪.

A message appears asking you to confirm the image setting.



6 Move the selector lever up ▲ to select [SET], then press ⏪.

The selected image is stored in the internal camera memory.

The user-defined screen setting is set and the startup screen is displayed for 1 second, and then the SET UP menu screen reappears.



Note

- This setting is retained when you turn the camera off.
- Because the selected images are stored in the camera's memory, switching memory cards or erasing the image from the memory card does not affect the images shown in the startup screen.





To set a user-defined screen (MULTI)

Important Check that the memory card containing the images you want to use is inserted into the camera.

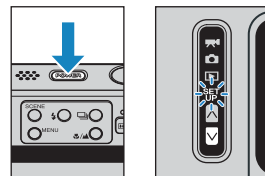

1 Turn the camera on and press the mode button  until "SET UP" lights up on the mode select LED.

The SET UP menu screen is displayed.



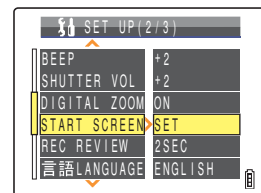

2 Move the selector lever up  or down  to select [START SCREEN], then move the lever right .

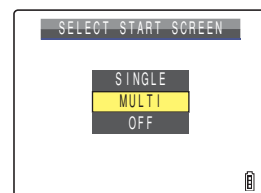

3 Move the selector lever up  or down  to select [MULTI], then press .



4 Move the selector lever left  or right  to select the center location, then move the lever down .

The image selection screen appears showing the still images stored on the memory card.

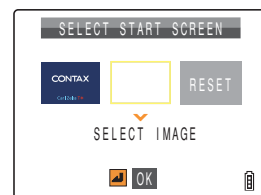

Note

If you select [RESET], the reset confirmation message appears. Select [EXECUTE] and press  to delete the user-defined screen set previously from the camera's memory.



5 Move the selector lever left ◀ or right ▶ to select an image and press .

A number is displayed in the lower left of the selected image. Repeat this procedure to select more images for the startup screen.

Note

You can select a maximum of 10 images. If you have selected 10 images, continue on to step 7.

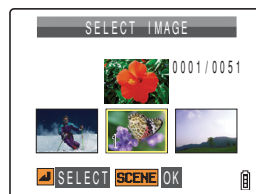

6 Press the **SCENE** button .

A message appears asking you to confirm the image setting.

Note

Once you have selected more than 6 images, you can move the selector lever left ◀ or right ▶ to check the remaining images.

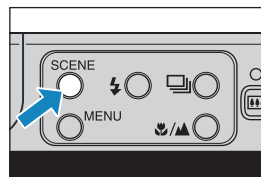

7 Move the selector lever up ▲ to select [SET], then press .

The selected image is stored in the internal camera memory.

The user-defined screen setting is set and the startup screen is displayed for 1 second, and then the SET UP menu screen reappears.

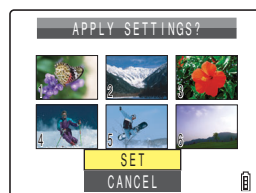

Note

- This setting is retained when you turn the camera off.
- Because the selected images are stored in the camera's memory, switching memory cards or erasing the image from the memory card does not affect the images shown in the startup screen.



Turning the startup screen off

- 1** Turn the camera on and press the mode button  until "SET UP" lights up on the mode select LED.

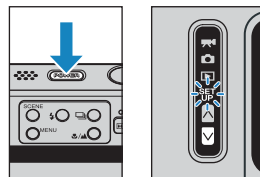

- 2** Move the selector lever up  or down  to select [START SCREEN], then move the lever right .

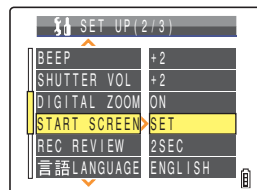

- 3** Move the selector lever down  to select [OFF], then press .

The startup screen is set to [OFF] and the SET UP menu screen reappears.

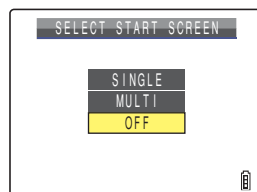

Note

This setting is retained when you turn the camera off.



[REC REVIEW] Checking Images Right After You Shoot Them

«Applicable mode: »

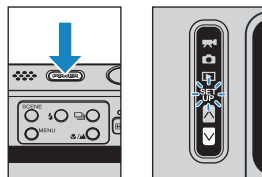

Use this procedure to have the camera display images for several seconds immediately after you shoot them.

- 1 Turn the camera on and press the mode button  until "SET UP" lights up on the mode select LED.

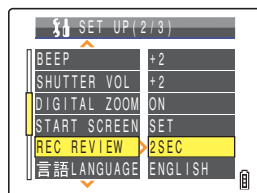

- 2 Move the selector lever up  or down  to select [REC REVIEW], then move the lever right .



- 3 Move the selector lever up  or down  to select the desired number of seconds and press .

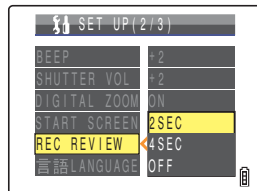

This sets the number of seconds to show images.

[2SEC] : The photographed image is displayed for 2 seconds right after shooting. (Default)

[4SEC] : The photographed image is displayed for 4 seconds right after shooting.

[OFF] : The photographed image is not displayed right after shooting.

Important This setting is retained when you turn the camera off.



[言語 LANGUAGE] Selecting the Menu Language

You can choose one of the following as the language displayed on the camera's screens:

- Japanese (Default)
- English
- French
- German
- Spanish
- Chinese (Simplified)

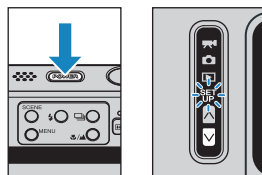
1 Turn the camera on and press the mode button  until "SET UP" lights up on the mode select LED.



2 Move the selector lever up  or down  to select [言語 LANGUAGE], then move the lever right .

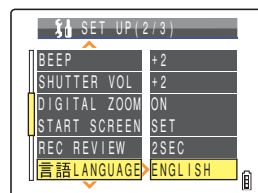

3 Move the selector lever up  or down  to select the language, then press .

The selected setting is applied.

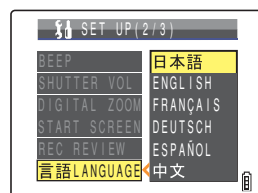

Note

This setting is retained when you turn the camera off.

[VIDEO OUT] Setting the Output Format for a TV Connection

You can choose between NTSC and PAL video output formats when the camera is connected to a television through the VIDEO OUT port on the USB cradle. Different TV signal formats are used in different countries. When you are on holiday, you should configure the video output to match the format for your destination country.

Note If the D connector cable is connected, the camera will automatically switch to D3 output format regardless of this setting.

1 Turn the camera on and press the mode button  until "SET UP" lights up on the mode select LED.

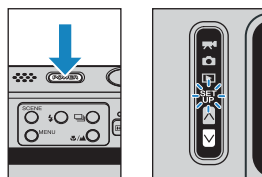

2 Move the selector lever up  or down  to select [VIDEO OUT], then move the lever right .

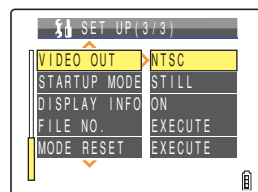

3 Move the selector lever up  or down  to select the video output format, then press .

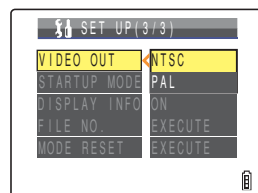

The selected setting is applied.

[NTSC]: Video output format used in, for instance, Japan and the U.S..
(Default)

[PAL] : Video output format used mostly in Europe.

Note This setting is retained when you turn the camera off.

[STARTUP MODE] Setting the Mode the Camera Starts In

The camera can be set to always start in still image mode when turned on, or to start in the same mode as the last time it was turned off.

- 1 Turn the camera on and press the mode button  until "SET UP" lights up on the mode select LED.

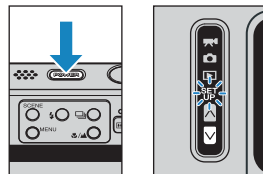

- 2 Move the selector lever up  or down  to select [STARTUP MODE], then move the lever right .

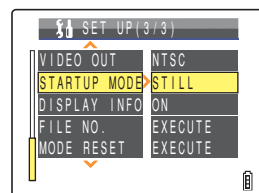

- 3 Move the selector lever up  or down  to select the desired mode, then press .

The selected setting is applied.

[STILL] : The camera switches to still image mode when it is turned on.
(Default)

[LOCK] : When you turn the camera on, the camera uses the mode used last time the power was turned off.

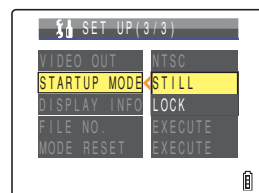

 **Note** This setting is retained when you turn the camera off.

[DISPLAY INFO] Choosing the Information Displayed on the Screen

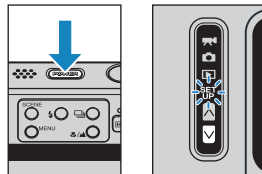

In "📷" and "📺" modes, a large number of icons are displayed on the LCD monitor. If you find the icons annoying when you are shooting, it is possible to change the display to make the screen easier to view.

1 Turn the camera on and press the mode button  until "SET UP" lights up on the mode select LED.

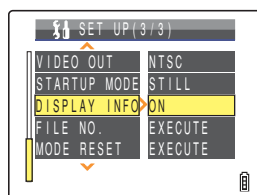

2 Move the selector lever up  or down  to select [DISPLAY INFO], then move the lever right .



3 Move the selector lever up  or down  to select the display style, then press .

The selected setting is applied.

[ON] : Icons for all of the current settings are displayed on the screen.
(Default)

[OFF] : Only the Flash mode, Macro/Landscape mode, Scene mode, Digital Zoom Magnification and Date are displayed.

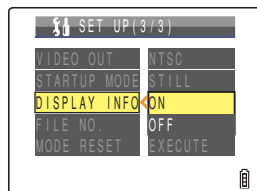

 **Note** This setting is retained when you turn the camera off.

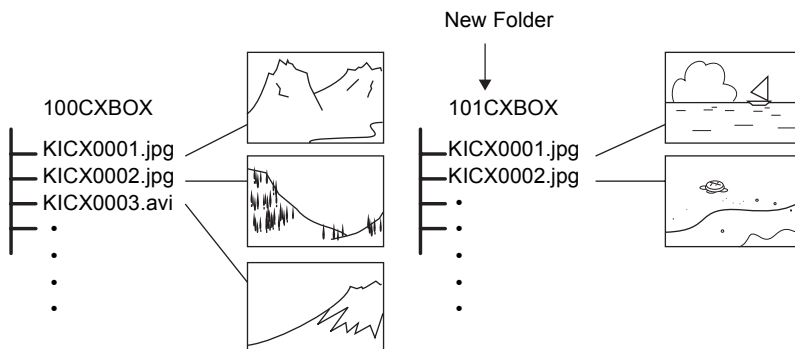

[FILE NO.] Starting Image File Numbers from 0001

Images shot on the camera are assigned file names that consist of sequential numbers before being saved in a folder called "100CXBOX". Executing [FILE NO.] creates a new folder "101CXBOX" and new images are stored in this folder. File names are numbered starting from "0001". Resetting the file number in this way is useful when you want to store shots of a particular scene in a different folder.

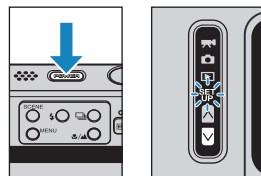

- 1 Turn the camera on and press the mode button  until "SET UP" lights up on the mode select LED.



- 2 Move the selector lever up  or down  to select [FILE NO.], then move the lever right .

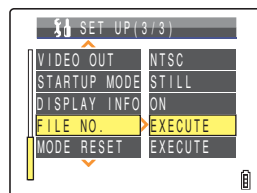

3 Move the selector lever up ▲ to select [EXECUTE], then press .

The image file numbers are reset and the SET UP menu screen reappears.

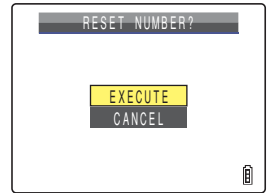

Note

- Folders "100CXBOX" to "999CXBOX" can be created.
- [FILE NO.] cannot be used if the "999CXBOX" folder has already been created.
- To reset the folder numbers and begin again from "100CXBOX", reset the file numbers without inserting the memory card and insert a formatted memory card before shooting.



[MODE RESET] Resetting Function Settings

Use this function when you want to reset the modes and menu settings that you have changed, back to their default settings.

- 1 Turn the camera on and press the mode button  until "SET UP" lights up on the mode select LED.

The SET UP menu screen is displayed.

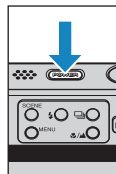

- 2 Move the selector lever up  or down  to select [MODE RESET], then move the lever right .

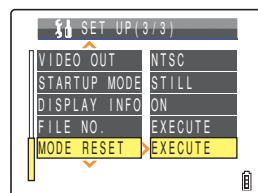





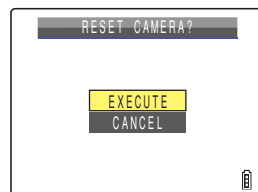











- 3 Move the selector lever up  to select [EXECUTE], then press .

The settings are reset and the SET UP menu screen reappears.



List of Menu Items and Default Values

Mode	Menu	After OFF	Default	Page
 Still image mode  Movie mode	 Flash mode	Default	Auto Flash	63
	 Continuous Shooting mode	Previous	Single-shot	44
	 Scene mode	Previous	Normal	53
	 Macro/Landscape mode	Default	Normal	56
	 SELF TIMER	Default	OFF	58
	 PIXELS	Previous	2272 x 1704	78
	 PIXELS	Previous	320 x 240	78
	 FRAME/SEC	Previous	30fps	49
	 EXP.COMP.	Default	±0.0	67
	 WHITE BALANCE	Previous	AUTO	80
	 ISO	Previous	AUTO	69
	 METERING	Previous	EVALUATION	71
	 FOCUSING	Previous	MULTI AF	73
	 CHROMA	Previous	STANDARD	83
	 SHARPNESS	Previous	STANDARD	84

After OFF: Menu setting after the camera is turned off.

Default : Reverts to the default setting.

Previous : Retains the setting specified before the camera was turned off.

- : Not applicable.



Mode	Menu	After OFF	Default	Page
SET UP SET UP mode	AF MODE	Previous	SAF	<u>77</u>
	FORMAT	-	-	<u>163</u>
	BRIGHT CNTRL	Previous	STANDARD	<u>164</u>
	DATE	Previous	-	<u>34</u>
	INSERT DATE	Previous	NO DATE	<u>165</u>
	POWER SAVE	Previous	1MIN.	<u>166</u>
	BEEP	Previous	+2	<u>169</u>
	SHUTTER VOL	Previous	+2	<u>170</u>
	DIGITAL ZOOM	Previous	ON	<u>61</u>
	START SCREEN	Previous	CONTAX logo screen (SINGLE)	<u>171</u>
	REC REVIEW	Previous	2SEC	<u>177</u>
	言語 LANGUAGE	Previous	Japanese	<u>178</u>
	VIDEO OUT	Previous	NTSC	<u>179</u>
	STARTUP MODE	Previous	STILL	<u>180</u>
	DISPLAY INFO	Previous	ON	<u>181</u>
	FILE NO.	-	-	<u>182</u>
MODE RESET	-	-	<u>184</u>	

After OFF: Menu setting after the camera is turned off.

Default : Reverts to the default setting.

Previous : Retains the setting specified before the camera was turned off.

- : Not applicable.



Troubleshooting

Check the items listed below before deciding that your camera is faulty.

Problems and Solutions

Problem	Cause	Solution	Page
Nothing appears on the LCD monitor.	The batteries are flat, or the Lithium Ion battery pack is not inserted.	Insert the Lithium Ion battery pack into the camera and recharge the camera.	<u>27</u> <u>29</u>
	The Power Save function has turned the camera off.	Press the POWER button  again to turn the camera back on.	<u>33</u>
The LCD monitor is blank.	If you leave the camera for a while without using it, the camera goes into Sleep mode.	Press the shutter release button half way or press any other camera button to restore the camera to Shooting mode. The details vary depending on the Power Save function settings.	<u>166</u>
	There is something generating a magnetic field (such as a magnet or TV) close to the camera.	Move the camera further away from the magnetic object.	-
	A video cable is connected to the USB cradle the camera is placed in.	Disconnect the video cable from the USB cradle.	<u>151</u>
There's no image on the TV.	You are using the wrong video output format.	Use the correct video output format for the TV.	<u>179</u>
The number of available shots did not change when I took a picture.	This is because the photographed image size was small.	This is dependent on factors such as the number of pixels and the subject and is not a problem.	-
I cannot erase an image. "⊞" icon displayed.	The image is protected.	Unprotect the image.	<u>107</u>

NEXT

Problem	Cause	Solution	Page
The number of available shots did not increase after I erased an image.	This is because the erased image size was small.	This is dependent on factors such as the number of pixels and the subject and is not a problem.	-
I cannot charge the battery.	There is no lithium-ion battery pack loaded in the camera.	Load a lithium-ion battery pack into the camera.	<u>27</u>
	The lithium-ion battery pack poles (+ and -) are the wrong way round.	Reload the lithium-ion battery pack correctly.	<u>27</u>
	The AC adapter is not connected correctly.	Check that the adapter is securely connected to the camera and the power socket.	<u>29</u>
	The battery pack terminals are soiled.	Wipe the terminals with a soft clean cloth.	-
I cannot charge the battery. Or charging stops. The caution LED flashes slowly.	The charging protection circuit was activated and halted charging because the ambient temperature is too high or too low.	Charge the battery when the ambient temperature is between 10°C and 30°C. (Charging is possible between 5°C and 40°C but will take slightly longer.)	-
The camera feels hot.	Because the LCD monitor uses relatively large amounts of current, the camera grows warm after prolonged use.	This is not a problem, but you should shut the camera down for a few minutes.	-
The caution LED flashes slowly.	The flash is charging.	Briefly take your finger off the shutter release button and wait.	<u>26</u>
The caution LED flashes quickly.	This is the camera shake warning. The shutter speed is slow.	Place the camera on a stable surface to take the picture.	<u>26</u>
The camera will not focus. The shooting mark flashes.	The subject is a type that is not suited to auto focus.	Use focus lock to focus on a strongly contrasting part of the subject, then compose the shot and take the picture.	<u>75</u>



Problem	Cause	Solution	Page
The picture came out completely white.	The image is overexposed.	Set the exposure compensation to a negative value, or execute mode reset.	<u>67</u> <u>184</u>
There is a lot of 'noise' in the image.	Noise is more likely to occur if high <u>ISO</u> settings are used.	Use the flash or reduce the ISO sensitivity before shooting.	<u>69</u>
I can't rotate images, protect images, specify <u>DPOF</u> settings or format the memory card.	The SD memory card is write-protected.	Remove the write-protection for the card.	<u>31</u>
When I connect the camera to my computer, no [Removable disk], [untitled] or [NO_NAME] icon appears.	The USB cable is not connected properly.	Make sure that the USB cable is securely connected.	<u>139</u> <u>147</u>
	The USB cable is connected to the keyboard or to the USB port on a USB hub.	Plug the USB cable into the USB port on the PC.	-
	The drivers are not installed, or installation failed.	Follow the procedure described in Deleting the Device (Windows 98 and Windows 98SE only).	<u>144</u>
I cannot connect to the printer.	The printer does not support <u>PictBridge</u> .	Refer to the instructions provided with the printer.	-
	The printer is not connected correctly.	Check that the camera is correctly connected to the printer with the USB cable.	<u>128</u>
	Movies cannot be printed.	-	-
	You cannot use DPOF printing if the printer does not support DPOF printing.	Refer to the instructions provided with the printer.	-



Messages and Responses

Message	Cause	Solution	Page
"MEMORY CARD FULL"	There is not enough recording space available on the memory card.	Insert a new memory card or erase some unwanted images.	<u>42</u>
	There are 9999 or more images recorded on the memory card.		
	The memory card contains a "999CXBOX" folder and a "KICX9999.jpg" file.	After you have saved the images you want keep on the computer, either format the memory card or erase all of the images.	<u>42</u>
"NO CARD"	There is no memory card inserted.	Insert a memory card.	<u>30</u>
"WRITE PROTECT"	The SD memory card is write-protected.	Remove the write-protection for the card or use another memory card.	<u>31</u>
"CARD ERROR" or "UNSUPPORTED FORMAT"	You are using a card that was formatted on another device.	Format the memory card in the camera.	<u>163</u>
	The format of the memory card is not compatible with this camera.	Insert a new memory card or format this memory card.	<u>163</u>
	The card is not inserted correctly.	Re-insert the memory card.	<u>30</u>
"NO IMAGE"	Nothing is recorded on the memory card.	Insert a memory card containing images, or take pictures.	-
"PLAYBACK NOT POSSIBLE"	The image file format is incompatible or no image files are recorded on the memory card.	Insert a different memory card or format the card.	<u>163</u>



Message	Cause	Solution	Page
"COVER OPENED"	The card/battery cover is open.	Close the card/battery cover.	<u>27</u>
"LOW BATTERY"	There is no charge left in the battery.	Charge the battery pack or use the AC adapter.	<u>29</u>
"PRINTER ERROR"	The printer is not ready to print.	Check that the printer is ready to print. Refer to the instructions provided with the printer for details.	-
	An error was detected in the connection to the printer.	Reconnect to the printer and then try again.	<u>128</u>
"PAPER ERROR" or "INK ERROR"	The printer is unable to print.	Check that the printer is able to print. Refer to the instructions provided with the printer for details.	-
"FILE ERROR"	The printer is unable to print the selected image.	The image cannot be printed. Refer to the instructions provided with the printer for details.	-



Basic Digital Camera Glossary

AE (Auto Exposure)

Automatic exposure is the function by which the camera automatically adjusts the exposure (the shutter speed and aperture settings) to suit the brightness of the subject.

AF (Auto Focus)

The function by which the camera automatically focuses images.

Aperture

This is a mechanism inside the camera lens that controls the amount of light passing through the lens by changing the size of an opening.

Aperture setting

A number that indicates the size of the aperture opening. Settings are displayed as numbers such as F2.8, and the higher the aperture setting, the smaller the opening and the less light that passes through the lens.

CCD (Charge Coupled Device)

This is a device that converts the light that enters the camera through the lens into digital information. Strictly speaking, a CCD is a tiny component and many hundreds of thousand of CCDs are used to make up the imaging element in a digital camera. The number of CCDs is referred to as the number of pixels. The larger the number of pixels, the greater the amount of information generated by converting light and the higher the resolution of the image.

DCF (Design rule for Camera File system)

This is a standard that stipulates items such as the file formats for digital cameras and related devices. In principle, digital cameras that conform to the DCF standard can freely exchange images, even when the images were shot with a different brand of camera. This camera complies with the DCF standard.

- DCF is a collective mark of the Japan Electronic Industry Development Association (JEIDA).

Depth of field

When a subject is in focus, the depth of field refers to the area in front of and behind the subject that is also in focus. The depth of field increases when the aperture setting is high. Such shots are said to have a large depth of field. Conversely, lower aperture settings give a narrow range in which objects are in focus. This is referred to as a small depth of field. The depth of field becomes smaller when the subject is closer to the camera.

A blue arrow pointing to the right with the word "NEXT" written inside in white capital letters.

DPOF (Digital Print Order Format)

DPOF is a standard used for printing images photographed using a digital camera on a home printer or at a commercial print processing store. Provided a DPOF-compatible printer or a commercial print processing store that provides a DPOF print service is used, prints specified on this (DPOF-compatible) camera will be produced in the quantities and formats specified in the DPOF settings.

- The DPOF trademark indicates that the product conforms to the specifications of the "Digital Print Order Format (DPOF) for digital camera print information". Copyright for DPOF Version 1.00 is held jointly by Canon Inc., Eastman Kodak Co., Fuji Photo Film Co., Ltd and Matsushita Electric Industrial Co., Ltd.

EV (Exposure Value)

An EV is a number that denotes exposure. EV=1 when the aperture setting is F1 and the shutter speed is 1 second. Each time the exposure then halves, the EV number increases by 1 (EV=2, EV=3...). Conversely, when the exposure is double the EV=1 level, the EV becomes -1. When the exposure is doubled again, EV=-2, and so on.

Exposure

This refers to the amount of light projected through the lens that strikes the camera's film or image sensor (CCD in this camera). The exposure is controlled by the combination of shutter speed and aperture setting. The image brightness is determined by the exposure.

Flash

This is a device that produces a bright flash of light when the camera shutter opens. Flash units are used in low-light situations such as indoor shots or pictures taken at night. Flash units tend to deplete the camera batteries if used frequently.

Focal length

This refers to the distance from the lens to a point that is in focus. At shorter focal lengths, the shot covers a wider area, while longer focal lengths make distant objects look larger.

Focus

This term refers to the focal point of a lens, but is more broadly used to refer to the condition whereby the subject of a photograph is seen most clearly. When the focusing is correct and the subject is clearly visible, the shot is said to be "in focus". When this is not the case, the shot is "out of focus".

Formatting (initialization)

This is a process that organizes the internal structure of a memory card so that files can be recorded on the card. Formatting a memory card erases all the existing data stored on that card.



Infinity

Once the subject of a photograph is further than a set distance away from the camera lens, moving still further away requires no adjustment to the focus. The distance at which the subject is so far away that no change in the focus occurs is referred to as "infinity".

ISO (International Organization for Standardization) sensitivity

This is a number that indicates the sensitivity of film to light, with higher values indicating greater sensitivity. Film with higher ISO sensitivity is more sensitive to light and can be used to take pictures in low-light conditions, but is also more susceptible to unwanted specks on the image (noise).

JPEG (Joint Photographic Experts Group)

This refers to an image data compression format. The compression ratio is variable, with higher compression ratios giving smaller image file sizes but poorer image quality.

Memory Card

A recording medium on which data can be written, erased and rewritten. SD memory cards and Multimedia cards can be used with this camera.

PictBridge

This is a printing standard that allows images to be printed directly from a digital camera or video camera via a USB cable, regardless of the manufacturer or model.

Red-eye effect

When a flash is used to take a picture of a person, the light of the flash reflecting from the back (retina) of the subject's eyes has the effect of making them appear to glow red. This camera is equipped with a red-eye reduction function to prevent this effect.

Shooting mark

The "●" mark displayed on the LCD monitor when the camera is ready to take a picture.

Shutter speed

This refers to the length of time that the camera's shutter (a curtain behind the lens) opens when a picture is taken.

Subject

This term refers to the person or object photographed by the camera. In portrait shots, the subject is the person. In shots of landscapes, the subject is the scenery.



TFT (Thin Film Transistor) color LCD monitor

The type of LCD monitor used in this camera. TFT panels provide good resolution and excellent responsiveness.

White Balance

The light emitted by fluorescent tubes or incandescent light bulbs differs slightly in color. Without any adjustment, the colors in shots taken under such light sources differ from the actual colors you see. For this reason, a white subject is used as a reference to adjust the colors before shooting so that the resulting photo shows the actual colors of the subject.

Zoom lens

This is a lens in which the photography scale can be changed gradually. In a zoom lens, the photography scale is varied by gradually changing the focal length.

Zooming

This refers to the gradual changing of the photography scale. Gradual enlargement of the subject is called "zooming in", while gradual reduction of the subject is called "zooming out".



Index

A

- AC adapter 29
- AE 192
 - AE Lock 75
- AF 192
 - AF continuous 44
 - AF MODE 77
 - CAF 77
 - SAF 77
- Aperture 192
 - Aperture setting 192
- Available Shooting Time 21, 48

B

- Battery level indicator 21
- Battery pack 27
- BEEP 169
- Black and White mode 55

C

- Camera case 37
- Camera connection terminal 18
- Camera shake 40
- Card/battery cover 17
- CCD 192
- Chroma 83
- Cleaning pad 38
- Continuous Shooting 44
 - Continuous shooting button 17
 - Image group 94
 - Viewing Continuous Shooting Images 94
- Cover glass 17

D

- D3 video output terminal 18
- DATE 34
- DCF 192
- Depth of field 192
- DISPLAY INFO 181
- Display mode 90
- DPOF 123, 193
 - Index Print 125

E

- ERASE 103
 - ERASE ALL 106
 - ERASE MULTIPLE 105
 - SELECT AND ERASE 104
- EV 193
- Exposure 193
 - Exposure compensation 67

F

- FILE NO. 182
- File number 51, 88
- Flash 193
 - Flash button 17
 - Flash icon 43
- Focal length 193
- Focus 73, 193
 - Focus frame 21
 - Focus Lock 75
 - MULTI AF 73
 - SPOT AF 73
- Format 163
- Formatting 193
- Frames per second 49

G

- GROUP Playback 90

I

- Infinity 194
- INFORMATION 24, 51, 88
- Initializing 163
- INSERT DATE 165
- ISO 69, 194

J

- JPEG 194

L

Landscape Mode 57

LANGUAGE 178

LCD

BRIGHT CNTRL 164

LCD monitor 17, 21

LED 25

Card access LED 17

Caution LED 17

Self-timer LED 17

Lens 17

Lens hood 17

M

Macintosh 146

Macro Mode 56

Macro/Landscape button 17

Memory Card 194

Menu 21, 185

MENU button 17

Metering mode 71

Mode button 17

MODE RESET 184

Mode select LED 17

Movies

Shooting Movies 47

Viewing Movies 96

MULTI Playback 90

N

Night Portrait mode 54

Night View mode 55

Number of available shots 21

Number of Pixels 78

P

PC 136, 146

PictBridge 128, 194

Playback 85

Portrait mode 54

POSTRECORDING 110

POWER button 17

POWER IN port 18

POWER SAVE 166

PROTECT 107

Unprotecting an image 108

Q

Quick View 51

R

REC REVIEW 177

Red-eye effect 194

RESIZE 114

RESIZE ALL IMAGES 118

Trimming 114

Rotating 121

S

SCENE button 17

Scene mode 53

SD Memory Card 31

Selector lever 17

Self-Timer 58

Sepia mode 55

Set Up 162

Sharpness 84

Shooting mark 21, 194

Shutter

Pressing the shutter release button half way 42

Shutter release button 17

Shutter speed 194

SHUTTER VOL 170

SINGLE Playback 93

Slideshow 98

Sports Action mode 54

START SCREEN 171

STARTUP MODE 180

Still Image

Taking Still Images 40

Viewing Still Images 86

Strap 37

Subject 194

Sunset mode 54



T

- Television 151
- Television that supports D3 or higher video input 153
- TFT 195
- Twilight mode 54

U

- USB
 - USB cable 129, 139, 147
 - USB driver 137
 - USB port 18
- USB Cradle 18, 36
 - USB Cradle Connector 17

V

- Video cable 151
- VIDEO OUT 179
 - VIDEO OUT port 18

W

- WB (White Balance) Preset 80
- White Balance 80, 195
- Windows 136
- Write-Protect 31

Z

- Zoom 195
 - DIGITAL ZOOM 60
 - Optical Zoom 60
 - Zoom lens 195

