



DLP PROJECTOR

Owner's Instructions | SP-H700/H710/H500

Table of Contents

Preparation

Features and Design	4
Caution on Lamp Use and Replacement	5
Projector and Accessories	
Front/Upper Side and Accessories	8
Rear Side and Cables	10
Remote Control Buttons	11
Operating the Remote Control.....	12
Installation and Basic Adjustments	
Installation and Turning On	14
Zooming and Focus Adjustment.....	16
Leveling with Adjustable Feet	17
Using the Lens Shift Dial	18
Screen Size and Projection Distance.....	19

Connections and Source Setup

Before Connections	22
Connecting to Video Equipment	
Connecting to VCR/Camcorder/Cable Box	23
Connecting to DVD	24
Connecting to the Digital TV Receiver.....	25
Setting up the External Input Source	26
Naming the External Connections	27

Picture Adjustment

Selecting Picture Mode	30
Custom Settings of the Picture	31
Changing the Color Standard	32
Selecting and Adjusting Color Temperature	33
Gamma Correction	34
Saving Custom Picture Settings	35
Setting up DNLe	36
Selecting Picture Size	37
Screen Position Adjustment	39
Film Mode	40
Overscan	41
Still Picture	42

Setup

Flipping/Reversing the Projected Image	44
Light Setting	45
Correcting Vertical Keystone	46
Test Patterns	47
Restoring the Factory Default Settings	48
Information	49

Menu Option

Setting the Language	52
Setting the Menu Position	53
Setting the Menu Translucency	54
Setting the Menu Display Time	55
Selecting Quick Menu	56

Connecting to PC

Before Connecting to PC	58
Setting up the PC Environment	59
Connecting to PC	60
Automatic Picture Adjustment	62
Frequency Adjustment	63
Fine Tuning with the Phase Adjustment	64
Zooming the Screen	65
Reset the PC	66

Troubleshooting

Before Contacting Service Personnel	68
---	----

Other Information

Storage and Maintenance	72
Purchasing Optional Parts	73
Structure of Screen Menu	74
Lamp Replacement	77
RS-232C Connection and Control	78
Specifications	80
Remote Control Specifications	81

Features and Design

Optical engine adopting advanced DLP technology

- SP-H700/SP-H710: DLP™ HD2+ DMD panel capable of 1280x720 resolution
- SP-H500: DLP™ ED2+ DMD panel capable of 1024x576 resolution
- 5X-speed color wheel designed to reduce digital artifacts
- 250W Lamp designed to improve luminance

Vivid colors

- Quality picture tuning focused on improving color - this unit aims at realizing color coordinates that meet broadcasting standards on video production.

Minimized fan noise and light leakage

- The airflow and fan installation structure are optimized to minimize fan noise and beam leakage.

Various Input Ports

- Five types of input ports including a DVI-D (compatible with HDCP) port, two Component ports improve connection to external peripherals.

User adjustments

- This unit allows adjustment of each input port.
- The unit has a reference pattern that can be used for positioning and adjustment.
- The remote control is backlit to improve usability in a dark environment.

Caution on Lamp Use and Replacement

Projector Lamp

- The Projector lamp changes in nature depending on time of use and using environment. Refer to the installation and other recommended operational sections of the user's manual to avoid rapid degradation of performance and deterioration of picture quality. The projector lamp requires regular replacement.
- Free servicing will be offered within 90 days after purchasing of the product and within 300 hours of product use, if the problem is due to a defective lamp.
- You can check the lamp use time by pressing the INFO button on the remote control.

Caution on Lamp Replacement

- Unplug the power cord before replacing the lamp.
- Inside of the projector is very hot. Cool off the projector for at least an hour after turning off.
- Contact your dealer to purchase a lamp for replacement. (Ultra violets from the lamp can damage your eyes.)
- Turn off the power of the lamp before replacement or repair. (Due to the high-pressure of the lamp, it is possible to explode.)
- When the lamp is broken, be careful not to be hurt by glass pieces. Refer to the manual for proper handling.

Caution on Lamp Use

- This projector produces intense light. Do not stare light source directly.
- Do not touch the exhaust vent during operation. It can be very hot.
- Do not expose the unit to rain or moisture.

V I S U A L R E A L I S M

Preparation

Projector and Accessories	8
Installation and Basic Adjustments	14

Front/Upper Side and Accessories

Front/Upper Side

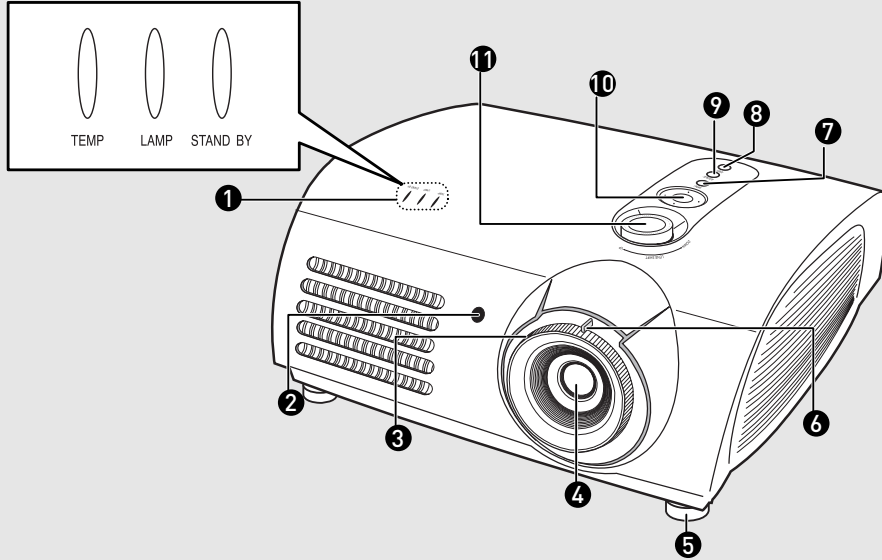

1 Indicators

- TEMP (Red LED)
- LAMP (Blue LED)
- STAND BY (Blue LED)

Refer to page 9 for details.

2 Remote Control Signal Receiver

3 Focus Ring

Used for Focus Adjustment.

4 Lens

5 Adjustable Feet

You can adjust the screen position by moving up and down the adjustable feet.

6 Zoom Knob

Used to enlarge or reduce image size.

7 MENU

Used to open the on-screen Menu.

8 POWER

Used to turn the projector on or off.

9 SOURCE

Used to select input signals from the external sources.

10 Select and Move Button

Used to select a menu item, and to move the cursor.

11 LENS SHIFT Dial

You can adjust screen images up and down within the lens range.

Accessories

Remote Control/
2 Batteries

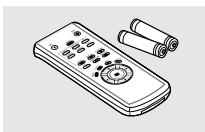

Power Cable



Owner's Instructions



Indicator Information

● : Turned On ●◐ : Flashing ○ : Turned Off

TEMP	LAMP	STANDBY	Information
○	○	●	If you press the POWER button on the remote control or projector, the screen appears within 30 seconds.
○	●	●	The projector is in normal operating condition.
○	●◐	●	The projector is warming up after POWER button has been pressed.
○	●◐	○	The POWER button is pressed to turn off the projector, and the cooling system is in operation to cool off inside of the projector. (Lasts for about 1 minute and 30 seconds)
●◐	○	●◐	Refer to measure 1 below if the cooling fan inside the projector is not in normal operation condition.
●◐	●◐	○	Refer to measure 2 below if the lamp cover protecting the lamp unit is not closed properly.
●◐	○	○	Power is turned off automatically when temperature inside of the projector goes beyond the control limit. Refer to measure 3.
●◐	●◐	●◐	Refer to measure 4 below if the life span of the lamp is running out or a problem with the lamp is detected.

Clearing Indicator Problems

Classification	State	Measures
Measure 1	When the cooling fan system is not in normal operating condition.	Unplug and plug the cord and restart the projector. If the problem does not disappear, contact a dealer or service personnel near you.
Measure 2	When the lamp cover protecting the lamp unit is not properly closed or the sensor system is not in normal operating condition.	Check the screw on the bottom side of the projector. If you do not find any problem, contact a dealer or service personnel near you.
Measure 3	When temperature inside of the projector becomes too high.	Adjust the position of the projector following the installation instructions of this manual and cool off the projector before restarting it. If the problem does not disappear, contact a dealer or service personnel near you.
Measure 4	The lamp is malfunctioning after abnormal power off or restarting right after turning off the projector.	Power off the projector and cool it off for some time before restarting it.
	When brightness of the picture screen degrades or image deterioration is found.	Check how long the lamp has been used on Information and contact a dealer or service personnel near you for lamp replacement.



NOTE

This Projector uses a cooling fan system to keep the unit from overheating.

Operation of the cooling fan may cause noise, which does not affect the product performance.

No exchange or refund for the noise concern.

Rear Side and Cables

Rear Side

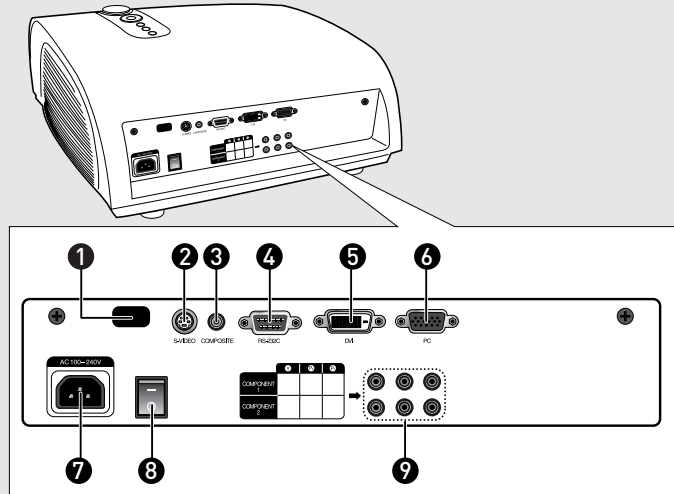

- | | | |
|----------------------------------|------------------|------------------------|
| 1 Remote Control Signal Receiver | 4 RS-232C port | 7 AC Power Input |
| 2 S-VIDEO Input port | 5 DVI Input port | 8 Power Switch |
| 3 COMPOSITE Input ports | 6 PC Input port | 9 Component Input port |

Cables

Power Cord

Connected to the wall outlet **7**.



Video (COMPOSITE) Cable

Connected to the connection port **3**.



S-Video Cable

Connected to the connection port **2**.



Component Cable

Connected to the connection port **9**.



PC Video Cable

Connected to the connection port **6**.

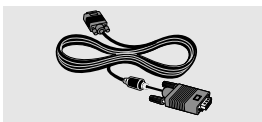

DVI-D Cable

Connected to the connection port **5**.

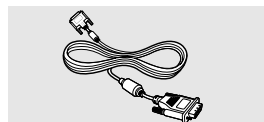

Remote Control Buttons

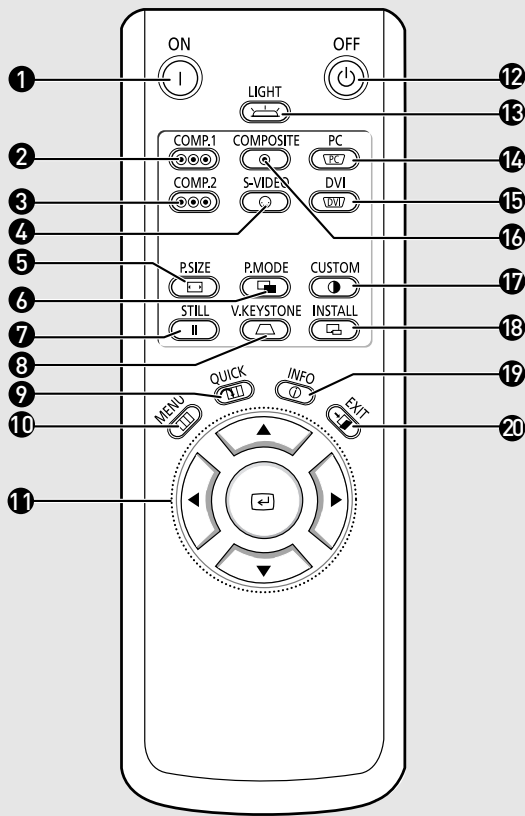

- 1 ON**
Used to turn on the projector.
- 2 COMP.1** (Pages 24~26)
Used to switch to COMPONENT 1 Mode.
- 3 COMP.2** (Pages 24~26)
Used to switch to COMPONENT 2 Mode.
- 4 S-VIDEO** (Pages 23, 26)
Used to switch to S-VIDEO Mode.
- 5 P.SIZE** (Page 37)
Used to adjust the size of picture screen.
- 6 P.MODE** (Page 30)
Used to select Picture Mode.
- 7 STILL** (Page 42)
Used to see still images.
- 8 V.KEYSTONE** (Page 46)
You can use this function for trapezoidal adjustment of the image.
- 9 QUICK** (Page 56)
Used to quickly select the previous menu.
- 10 MENU**
Used to display Menu Screen.
- 11 ▲▼◀▶ (Move) / ⏏ (Select)**
Used to move to or select each menu item.
- 12 OFF**
Used to turn off the projector.
- 13 LIGHT** (Page 13)
Used to operate remote control in dark room.
- 14 PC** (Pages 25, 60, 62~66)
Used to switch to PC Mode.
- 15 DVI** (Page 25, 60)
Used to switch to DVI Mode.
- 16 COMPOSITE** (Pages 23, 26)
Used to switch to COMPOSITE Mode.
- 17 CUSTOM** (Page 31)
Used to select Picture User Adjust Mode.
- 18 INSTALL** (Page 44)
Used to flip or reverse the projected image.
- 19 INFO** (Page 49)
Used to check source signals, picture setup, PC screen adjustment and lamp lifespan.
- 20 EXIT**
Used to make Menu Screen disappear.

Operating the Remote Control

Operating Move/Select Button

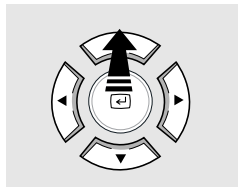
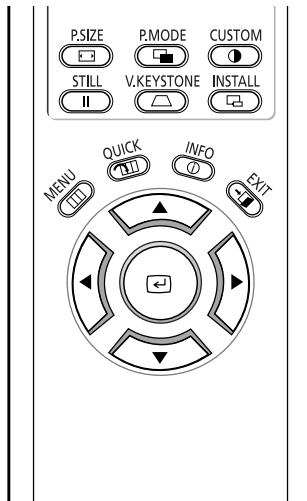

Move Menu Item (Up)



Move Menu Item (Down)

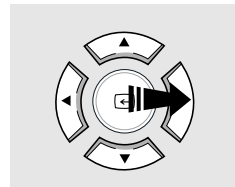

Setting the Adjustment (right), or move to lower item.

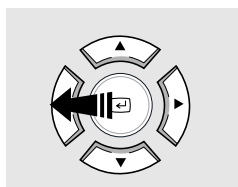

Setting the Adjustment (left), or move to upper item

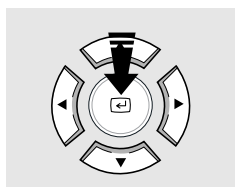

Select the current setting

Inserting Batteries into Remote Control

1. Press on the ▼ part of the lid to remove it.
2. Insert two AAA-sized 1.5V batteries by matching +/-.
3. Close the lid.

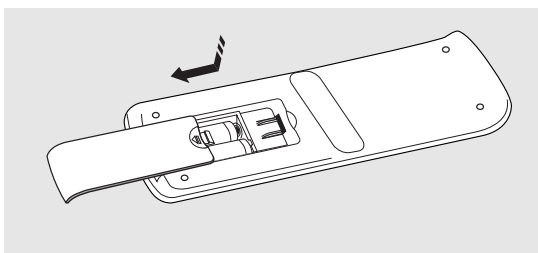

Allowable range & angle of receiving the remote control signal

The remote control is effective within a 30° angle 23~33 ft (7~10m) from the projector.

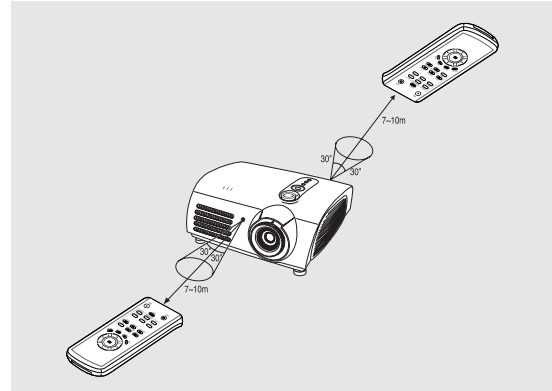

- Keep used batteries away from children and dispose of them properly.
- Do not use new and used batteries together. Replace two batteries at the same time.
- Remove batteries when the projector is not used for long periods of time.

Using Remote Control in Dark Place (LIGHT)

Press the LIGHT button of the remote controller for five seconds. The remote control buttons are lit for about 5 seconds and turn off automatically.

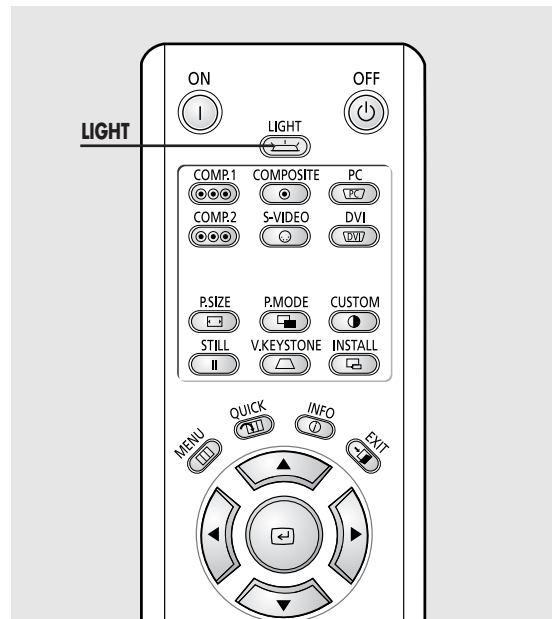

Installation and Turning On

To Install the Projector

Install the projector so that the projection is perpendicular to the screen.



NOTE

- Center the lens to the screen. If the projector is not positioned perpendicular to the screen, the image may appear trapezoidal.
- Do not install the screen in a bright place as it makes it harder to see the screen.
- Darken the room when installing the projector in a bright place.

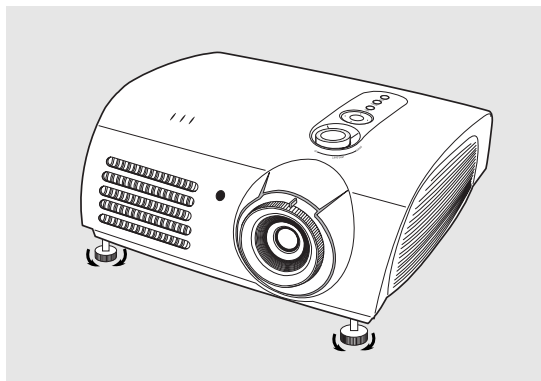

Installing Projector on Backside of Screen

Install a translucent screen to place the projector on the backside of the screen. The Translucent will show the horizontally flipped image. Rotate the image (projected from the projector) horizontally. (Page 44)

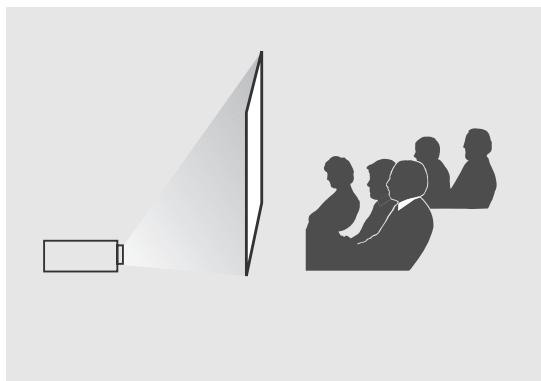

Installing Projector in Front of the Screen

Install the projector at the viewers' side.



NOTE

- The projector may be installed on the ceiling in front / back side of the screen.
- When installing the projector on the ceiling, contact your dealer.

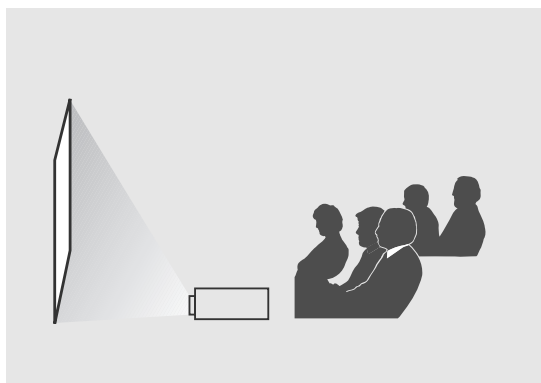

Turning On Projector

1. Plug the power cord into the power terminal on the rear side of the projector.
2. Press and push the power switch on the rear side of the projector toward "—".
3. Press the **POWER** button of the projector or the **ON** button of the remote control.
4. Screen display comes up in 30 seconds.

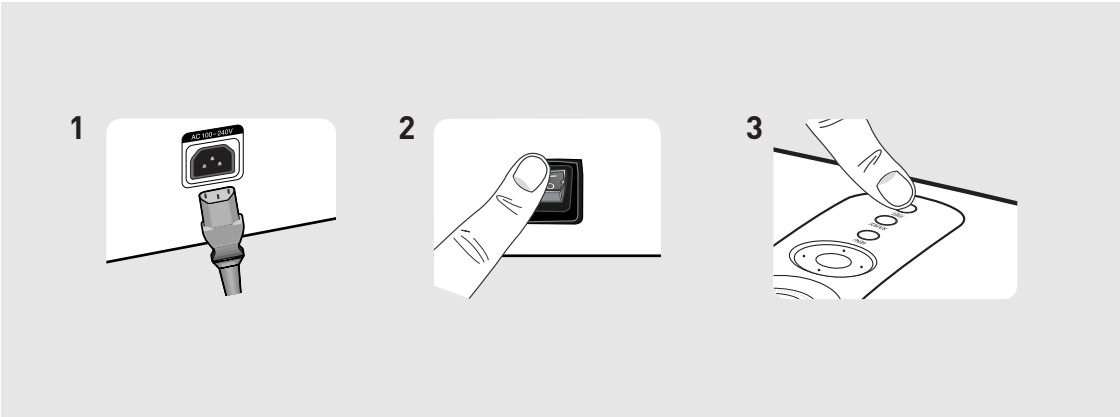
**NOTE**

- When you turn off the projector, the cooling fan stops within 1 minute and 30 seconds.
- When the cooling fan stops, push the power switch toward "O" and unplug the power cord.

Zoom and Focus Adjustment

Using the Zoom Knob and the Focus Ring

1. You can adjust the size of image within zoom range by manipulating the Zoom Knob.
2. Focus the picture on the screen using the Focus Ring.

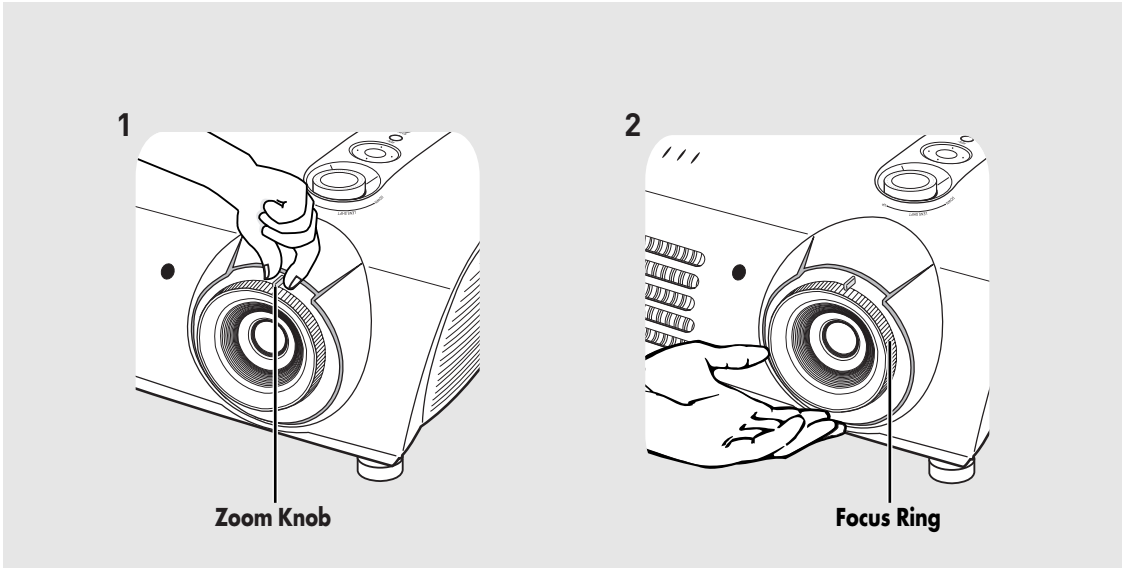

NOTE

Focus may appear dim if the projector is installed at a shorter than recommended distance. (Page 20)

Leveling with Adjustable Feet

Using Adjustable Feet

For level placing of the projector, adjust the Adjustable Feet of the projector.

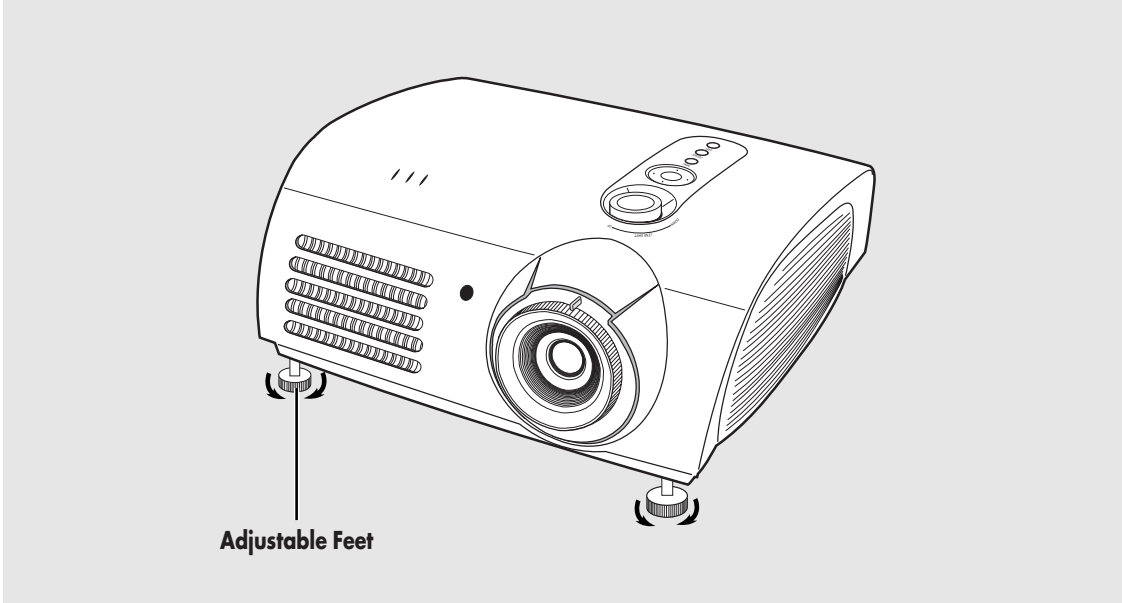

NOTE

- You may adjust the level of the projector up to 5 degrees.
- Depending on the position of the projector, Keystone distortion of image may appear. (Page 46)

Using the Lens Shift Dial

Using the Lens Shift Dial

Move the picture projected on the screen up and down within the lens range by turning the Lens Shift Dial on the top side of the projector with your fingers.

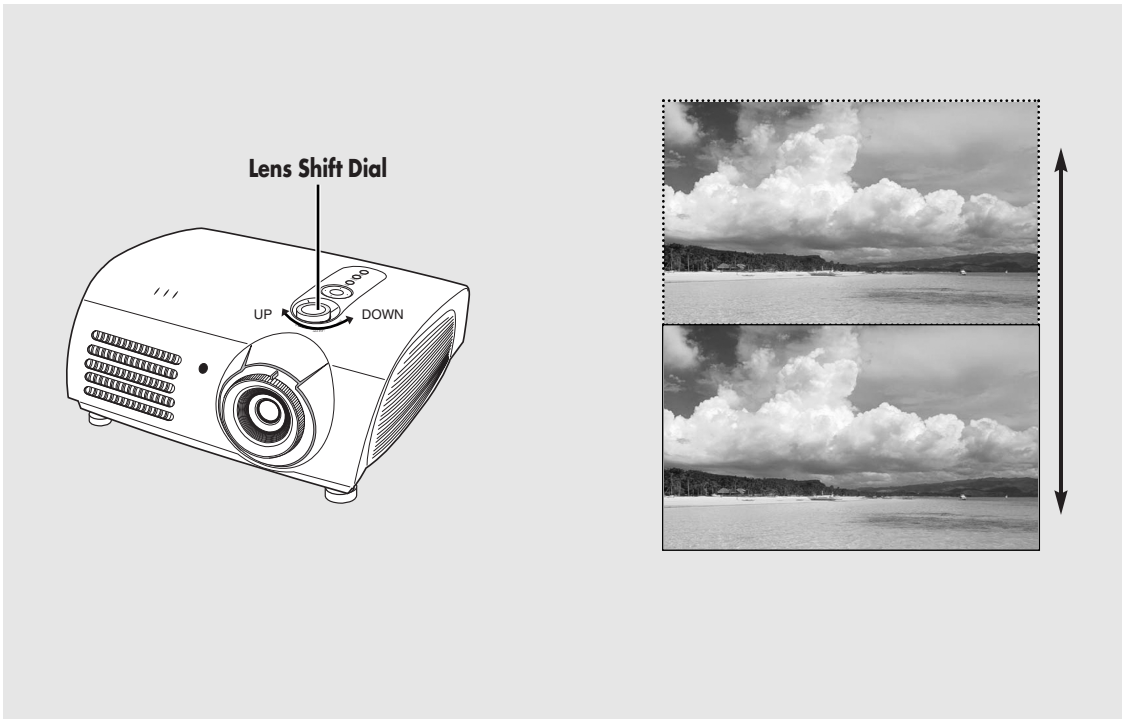

INSTALLATION AND BASIC ADJUSTMENTS

Screen Size and Projection Distance

Check the following before reading this manual.

Install the projector on a flat, even surface and level the projector using the adjustable feet to realize optimal picture quality. If images are not clear, adjust them using the Zoom Knob or Focus Ring, or move the projector forward and backward.

SP-H700/SP-H710

Diagonal Image Size (inch)	Screen Size (16:9)		Throw Distance (Z)		Distance from Lens Center to Image Bottom (Z':cm/inch)
	Horizontal (X:cm/inch)	Vertical (Y:cm/inch)	Min (m/ft)	Max (m/ft)	
300	666.3/262.3	374.6/147.2	10.5/34.0	13.6/44.8	31.2/12.3
250	555.3/218.6	312.2/122.9	8.6/28.3	11.4/37.3	26.0/10.2
200	444.2/174.9	249.7/98.3	6.9/22.7	9.1/29.8	20.8/8.2
190	422.0/166.1	237.2/93.4	6.6/21.5	8.6/28.4	19.8/7.8
180	399.8/157.4	224.7/88.5	6.2/20.4	8.2/26.9	18.7/7.4
170	377.6/148.7	212.3/83.6	5.9/19.3	7.7/25.4	17.7/7.0
160	355.4/139.9	199.8/78.7	5.5/18.1	7.3/23.9	16.6/6.5
150	333.2/131.2	187.3/73.7	5.2/17.0	6.8/22.4	15.6/6.1
140	311.0/122.4	174.8/68.8	4.8/15.9	6.4/20.9	14.6/5.7
130	288.7/113.7	162.3/63.9	4.5/14.7	5.9/19.4	13.5/5.3
120	266.5/104.9	149.8/59.0	4.1/13.6	5.5/17.9	12.5/4.9
110	244.3/96.2	137.3/54.1	3.8/12.5	5.0/16.4	11.4/4.5
100	222.1/87.4	124.9/49.2	3.5/11.3	4.5/14.9	10.4/4.1
90	199.9/78.7	112.4/44.3	3.1/10.2	4.1/13.4	9.4/3.7
80	177.7/70.0	99.9/39.3	2.8/9.1	3.6/11.9	8.3/3.3
70	155.5/61.2	87.4/34.4	2.4/7.9	3.2/10.4	7.3/2.9
60	133.3/52.5	74.9/29.5	2.1/6.8	2.7/9.0	6.2/2.4
50	111.143.7	62.4/24.6	1.7/5.7	2.3/7.5	5.2/2.0
43	95.5/37.6	53.7/21.1	1.5/4.9	1.9/6.4	4.5/1.8
40	88.8/35.0	49.9/19.6	1.4/4.5	1.8/6.0	4.2/1.7
33	73.3/28.9	41.2/16.2	1.1/3.7	1.5/4.9	3.4/1.3
30.385	67.5/26.6	37.9/14.9	1.0/3.4	1.4/4.5	3.2/1.3



This projector is designed to show images optimally on a 80 to 150 inch sized screen.

NOTE

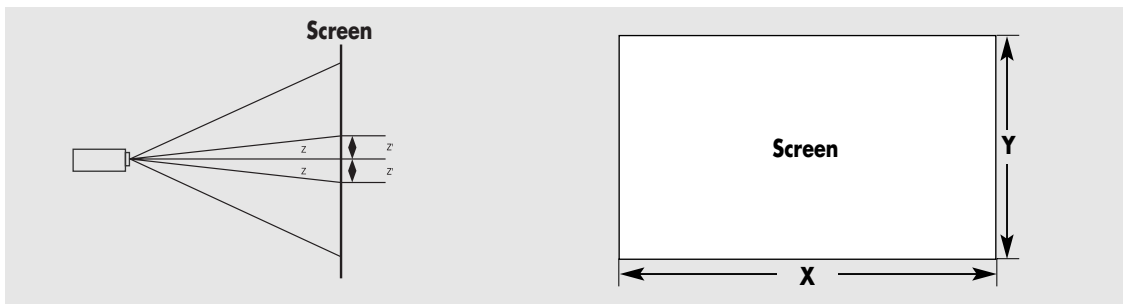

NOTE

- Z : Throw Distance
- Z' : Distance from Lens Center to Image Bottom

Screen Size and Projection Distance

SP-H500

Diagonal Image Size (inch)	Screen Size (16:9)		Throw Distance (Z)		Distance from Lens Center to Image Bottom (Z':cm/inch)
	Horizontal (X:cm/inch)	Vertical (Y:cm/inch)	Min (m/ft)	Max (m/ft)	
200	442.8/174.3	249.1/98.1	6.8/22.4	8.8/28.5	24.9/9.8
190	420.6/165.6	236.6/93.1	6.5/21.3	8.3/27.1	23.7/9.3
180	398.5/156.9	224.1/88.3	6.1/20.1	7.8/25.7	22.4/8.8
170	376.3/148.1	211.7/83.3	5.8/19.0	7.4/24.2	21.2/8.3
160	354.2/139.5	199.2/78.4	5.5/17.9	7.0/22.8	19.9/7.8
150	332.1/130.7	186.8/73.5	5.1/16.8	6.5/21.4	18.7/7.4
140	309.9/122.0	174.3/68.7	4.8/15.6	6.1/19.9	17.4/6.9
130	287.8/113.3	161.9/63.7	4.4/14.5	5.6/18.5	16.2/6.4
120	265.7/104.6	149.4/58.8	4.1/13.4	5.2/17.1	14.9/5.9
110	243.5/95.9	137.0/53.9	3.7/12.3	4.8/15.6	13.7/5.4
100	221.3/87.1	124.5/49.0	3.4/11.1	4.3/14.2	12.5/4.9
90	199.2/78.4	112.1/44.1	3.0/10.0	3.9/12.8	11.2/4.4
80	177.1/69.7	99.6/39.2	2.7/8.9	3.5/11.3	10.0/3.9
70	155.0/61.0	87.2/34.3	2.4/7.7	3.0/9.9	8.7/3.4
60	132.8/52.3	74.7/29.4	2.0/6.6	2.6/8.5	7.5/2.9
50	110.7/43.6	62.3/24.5	1.7/5.5	2.1/7.0	6.2/2.5
40	88.6/34.9	49.8/19.6	1.3/4.4	1.7/5.6	5.0/2.0



This projector is designed to show images optimally on a 80 to 150 inch sized screen.

NOTE

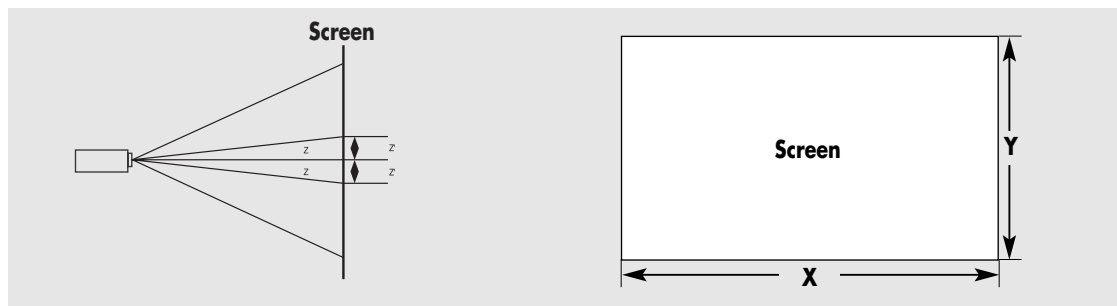

- Z : Throw Distance
- Z' : Distance from Lens Center to Image Bottom

NOTE

Connections and Source Setup

Before Connections	22
Connecting to Video Equipment	23
Setting up the External Input Source	26
Naming the External Connections	27

Before Connections

Check the followings before connecting the projector to other devices.

Check the following Before Connecting

1. Refer to the manual of the device the projector is connected to. The number and position of ports may differ depending on type of devices.
2. Do not connect power until all the connections are completed. If you try to connect power while connecting cables, it may result in damage to the projector.
3. Check the type of ports the projector is connected to.

Refer to "Rear Side and Cables" on page 10 for cables used for connection.

CONNECTING TO VIDEO EQUIPMENT

Connecting to VCR/Camcorder/Cable Box

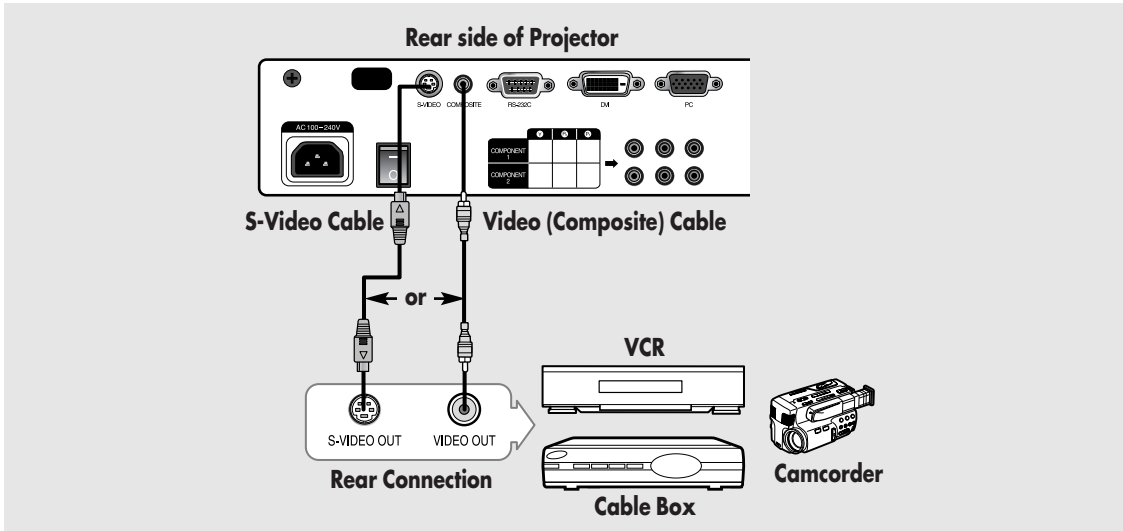

Connect COMPOSITE (yellow) input port of the projector to the VIDEO OUT (yellow) port of video equipment using the video cable.

- If the video equipment has S-VIDEO OUT port, connect it to S-VIDEO input port of the projector.

Viewing the picture

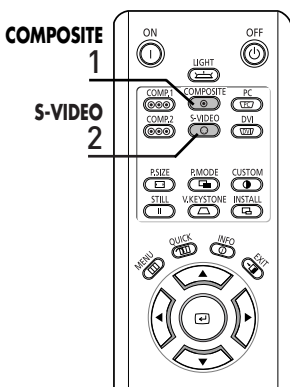

1 Turn on the projector and press the COMPOSITE button to select Composite.

2 Connect the projector and the video equipment via S-Video cable and press the S-VIDEO button to select S-Video.

- When Composite Mode is not available, check the video cables are in place.



NOTE

- Check that the projector and the video equipment are turned off before connecting cables.
- This projector does not support sound. (Separate audio system is needed for sound.)

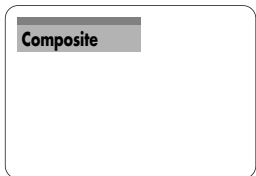

CONNECTING TO VIDEO EQUIPMENT

Connecting to DVD

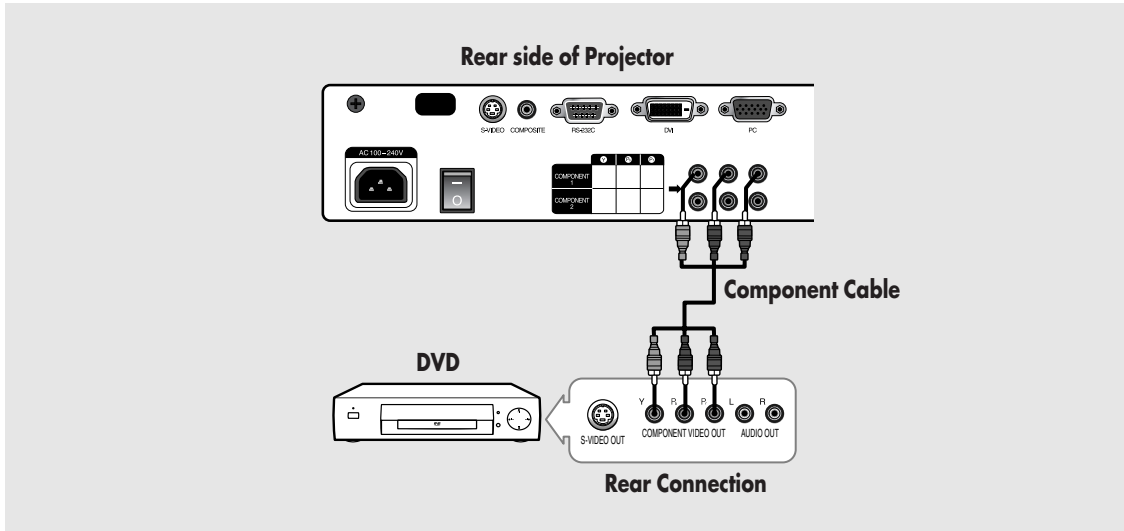

Connect COMPONENT1 or COMPONENT2 (Y/Pb/Pr) ports of the projector to Component port on the rear side of DVD using Component Cable.

Viewing the picture

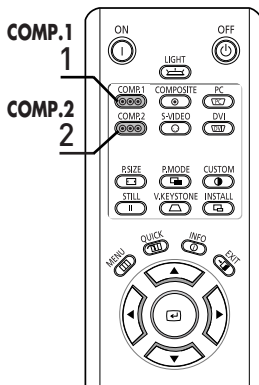

- 1 Turn on the projector and press the COMP.1 button to select Component 1.
- 2 Press the COMP.2 button to select Component 2 if COMPONENT2 is connected.
 - When Component Mode is not available, check that the component cables are in place.

Component1



NOTE

Component Ports are marked as (Y, Pb,Pr), (Y, B-Y, R-Y) or (Y, Cb, Cr) depending on the manufacturer.

CONNECTING TO VIDEO EQUIPMENT

Connecting to the Digital TV Receiver

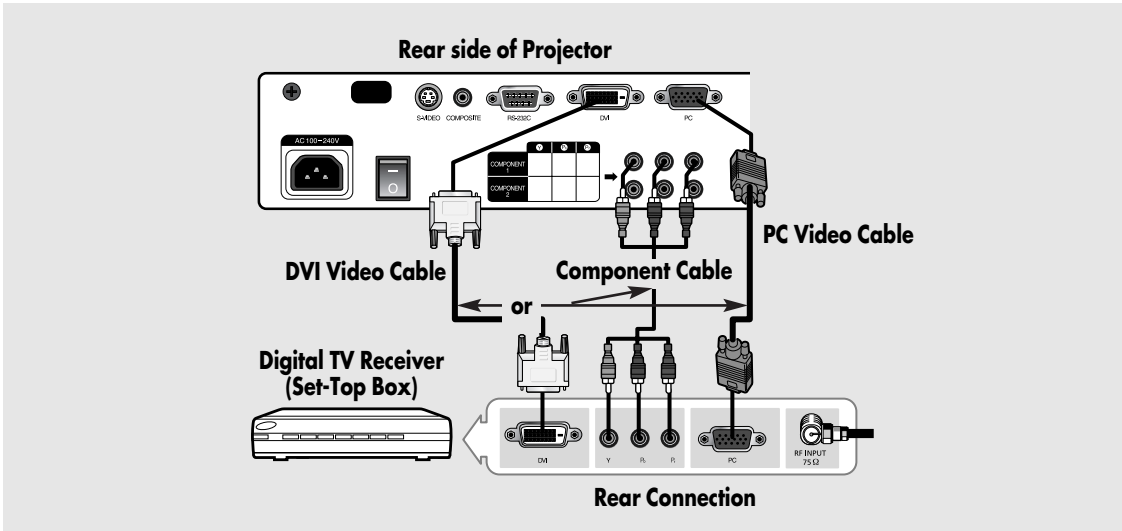

1 Connect antenna cable to antenna signal input terminal of the receiver.

2 Connect COMPONENT1 or COMPONENT2 (Y/Pb/Pr) port of the projector to Component port of the receiver using Component Cable.

- If the receiver has DVI or PC OUT port, you can connect it to DVI or PC input port of the projector.

Viewing the picture

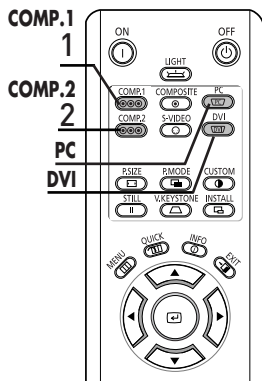

- 1 Turn on the projector and press the COMP.1 button to select Component1.
- 2 Press the COMP.2 button to select Component2 if COMPONENT2 is connected. If the receiver is connected to DVI or PC port, press the DVI or PC button to select DVI or PC respectively.
 - When Component Mode is not available, check that the component cables are in place.

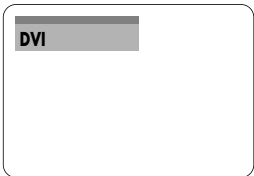
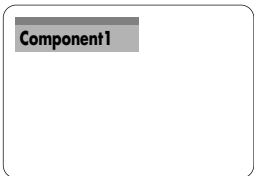

Setting up the External Input Source

You can select a device connected to the projector to display.

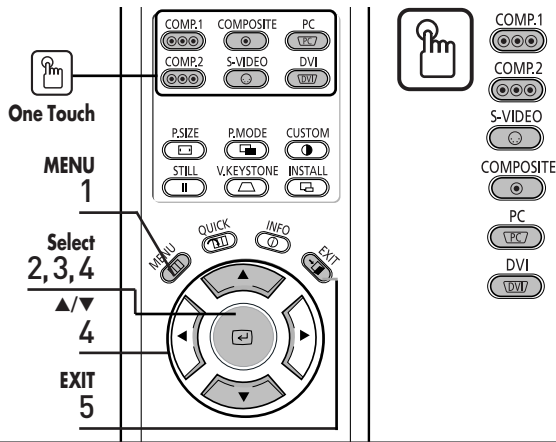



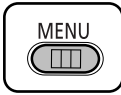

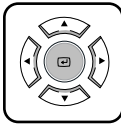
Press the desired source button (**COMP.1/COMP.2/ S-VIDEO/COMPOSITE/ PC/DVI**). Pressing a button switches to the respective mode. You can not switch to the mode if the projector is not connected to the respective device.

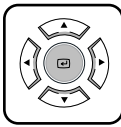
- 

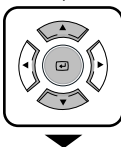
1 Press the **MENU** button.
The main menu is displayed.
- 

2 Press the  button to select **Input**.
The **Input** menu is displayed.
- 

3 Press the  button to select **Source List**.
The **Source List** menu is displayed.
- 

4 Press the  or  button to move to desired input mode, then press the  button.
The source input you chose is displayed.
If the input mode is not selected, check that cables are in place.
- 

5 Press the **EXIT** button to exit the menu.

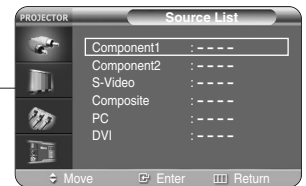

Naming the External Connections

You can select and set up the type of device you want to connect to the projector.

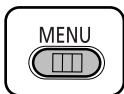
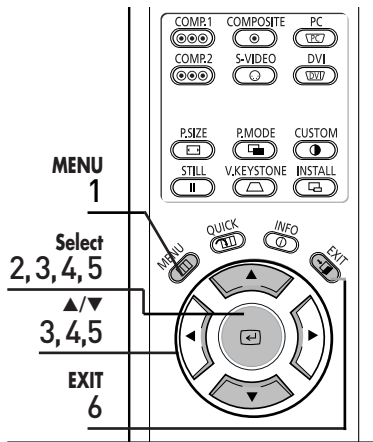

1 Press the **MENU** button.
The main menu is displayed.

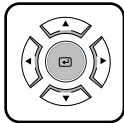

2 Press the button to select **Input**.
The **Input** menu is displayed.

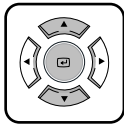

3 Press the **▲** or **▼** button to move to **Edit Name**,
then press the button.
The **Edit Name** menu is displayed.



4 Press the **▲** or **▼** button to move to edited input
mode, then press the button.

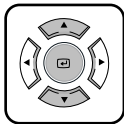

5 Press the **▲** or **▼** button to move to desired
device, then press the button.
Setup is switched to the selected device.

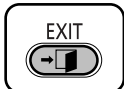

6 Press the **EXIT** button to exit the menu.

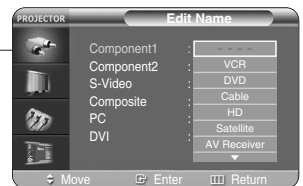
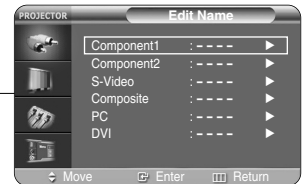
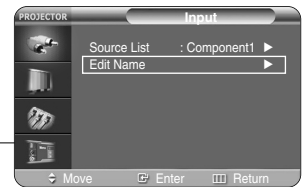

Picture Adjustment

Selecting Picture Mode	30
Custom Settings of the Picture	31
Changing the Color Standard	32
Selecting and Adjusting Color	
Temperature	33
Gamma Correction	34
Saving Custom Picture Settings	35
Setting up DNle	36
Selecting Picture Size	37
Screen Position Adjustment	39
Film Mode	40
Overscan	41
Still Picture	42

Selecting Picture Mode

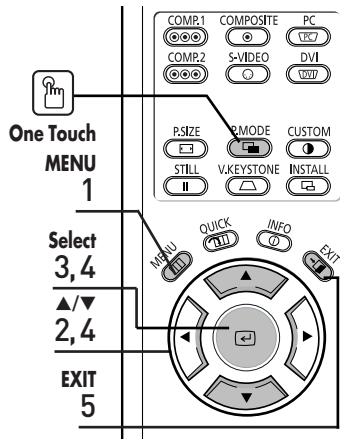

Press the **P.MODE** button.

Each press of the button, picture mode is switched to **Dynamic**, **Standard**, **Movie1**, **Movie2**, **User1**, **User2**, **User3** and **Custom**.

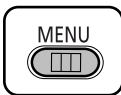
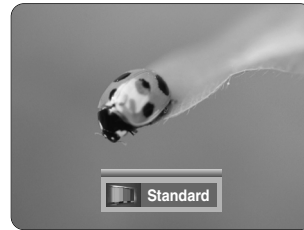

1 Press the **MENU** button.
The main menu is displayed.

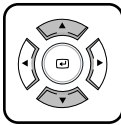

2 Press the **▲** or **▼** button to move to **Picture**.
The **Picture** menu is displayed.

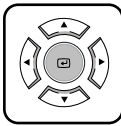

3 Press the **←** button.
The **Picture Mode** is selected.

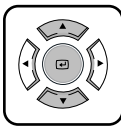

4 Press the **←** button again.
Press the **▲** or **▼** button to move to desired mode, then press the **←** button.
Setup is switched to the selected mode.

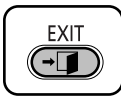

5 Press the **EXIT** button to exit the menu.

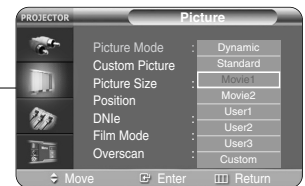
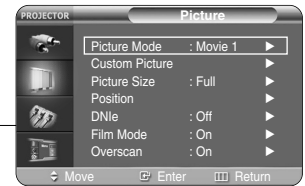

Picture Modes	Color Temperature	Gamma
Dynamic	9300K	Gamma Mode3: Graphic Mode
Standard	8000K	Gamma Mode2: Video Mode
Movie1	6500K	Gamma Mode1: Film Mode
Movie2	5500K	



NOTE

User 1, 2, and 3 Saving Options are designed for setup and storage of various users' customized picture modes.

Custom Settings of the Picture

You can adjust **Contrast**, **Brightness**, **Sharpness**, **Color** and **Tint** of the picture as desired.

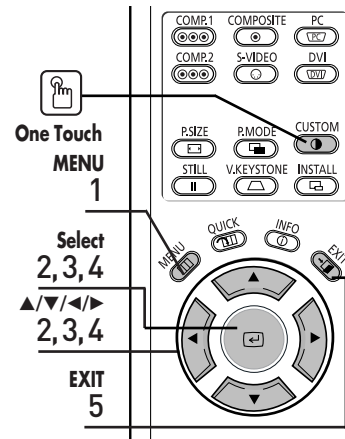

CUSTOM

Press the **CUSTOM** button.

The **Custom Picture** menu is displayed.
Refer to number 4 below to make adjustments.

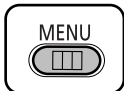
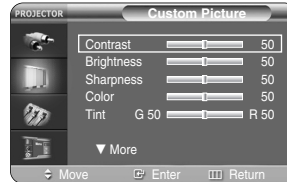

1 Press the **MENU** button.
The main menu is displayed.

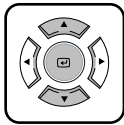

2 Press the **▲** or **▼** button to move to **Picture**.
The **Picture** menu is displayed.
Press the **←** button.

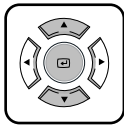

3 Press the **▲** or **▼** button to move to **Custom Picture**, then press the **←** button.
The **Custom Picture** menu is displayed.

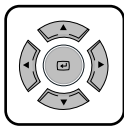
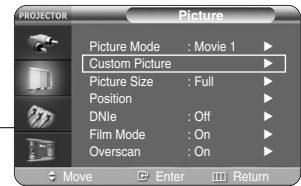

4 Press the **▲** or **▼** button to move to desired item, then press the **←** button.
Press the **◀** or **▶** button to adjust the selected item.

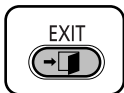
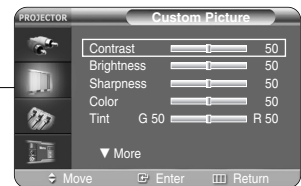

5 Press the **EXIT** button to exit the menu.



Custom Picture Menu

Contrast	Used to adjust the contrast between the object and the background.
Brightness	Used to adjust brightness of the entire picture.
Sharpness	Used to adjust the outlines of the object sharper or less sharp.
Color	Used to adjust color lighter or deeper.
Tint	Used to obtain more natural color of objects using Green or Red enhancement.



NOTE

You cannot adjust tint when the input of **COMPONENT1** and **COMPONENT2** are set at 480p, 720p and 1080i.

Changing the Color Standard

You may adjust the color standard to suit the color standard of the input signal.

Picture Adjustment

Changing the Color Standard

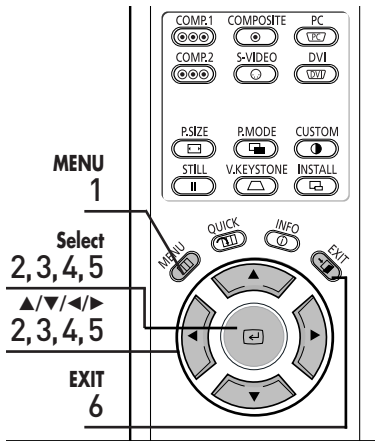

Color Standard		
SMPTE_C	Standardized for Video Equipment by the Society of Motion Picture and Television Engineers	NTSC
HD	High Definition, 1125 scan lines, standard definition TV submitted to the ITU-R by U.S., Japan and Canada, in 1986.	ATSC
EBU	Regulations and standards for European Broadcasting Production and Technology, standardized by the European Broadcasting Union.	PAL, SECAM

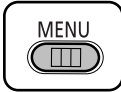
- 

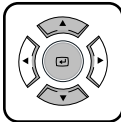
1 Press the **MENU** button.
The main menu is displayed.
- 

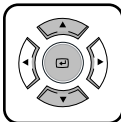
2 Press the **▲** or **▼** button to move to **Picture**.
The **Picture** menu is displayed.
Press the **↵** button.
- 

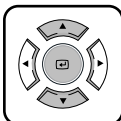
3 Press the **▲** or **▼** button to move to **Custom Picture**, then press the **↵** button.
The **Custom Picture** menu is displayed.
- 

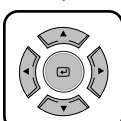
4 Press the **▲** or **▼** button to move to **Color Standard**, then press the **↵** button.
The **Color Standard** menu is displayed.
- 

5 Press the **◀** or **▶** button to adjust the selected item.
- 

6 Press the **EXIT** button to exit the menu.

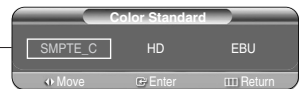
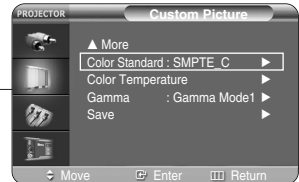
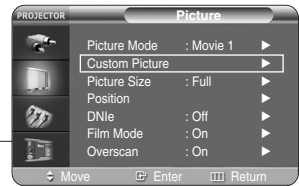

Selecting and Adjusting Color Temperature

You can change tint of the entire screen to suit your needs.

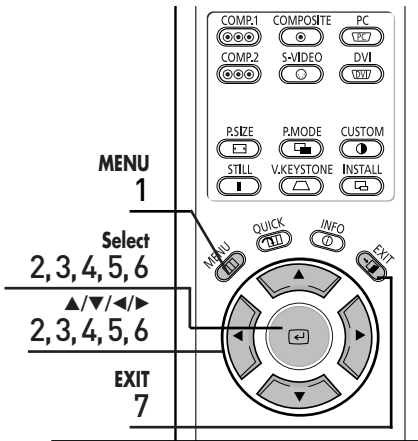

Color Temperature Menu

5500K	Used to deliver optimal image quality for black-and-white films. Color temperature of the picture mode of Movie2 is set to 5500K.
6500K	This temperature is used for the most video productions. It is set as Movie1 when it is manufactured, and may deliver the most precise tint.
8000K	This mode is applied to bright places such as showrooms and other sales outlet. Sharpness and brightness are enhanced. It is suitable for brighter environments and is set to the Dynamic Mode .
9300K	With both Sharpness and Brightness enhanced, this dynamic mode can be effectively used in bright ambient light conditions.

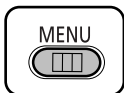

1 Press the **MENU** button.
The main menu is displayed.

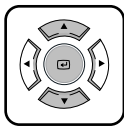

2 Press the **▲** or **▼** button to move to **Picture**.
The **Picture** menu is displayed.
Press the **↵** button.

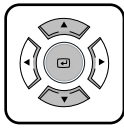

3 Press the **▲** or **▼** button to move to **Custom Picture**, then press the **↵** button.
The **Custom Picture** menu is displayed.

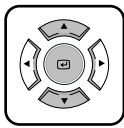

4 Press the **▲** or **▼** button to move to **Color Temperature**, then press the **↵** button.
The **Color Temperature** menu is displayed.

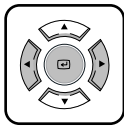

5 Press the **◀** or **▶** buttons to select an option then press the **↵** button.
The selected option is applied.

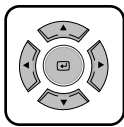

6 Press the **▲** or **▼** buttons to select an option then press the **↵** button. Press the **◀** or **▶** buttons to adjust the selected item.
A separate adjustment window appears for making the adjustment.

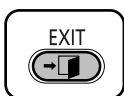

7 Press the **EXIT** button to exit the menu.

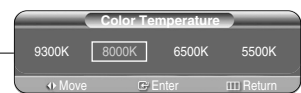
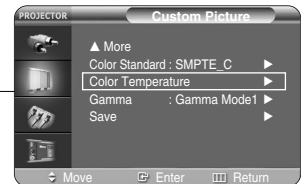
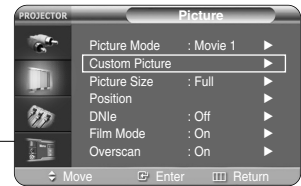

Gamma Correction

Gamma is used to improve the picture quality with color balance.

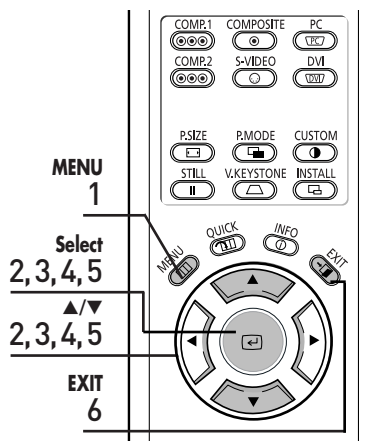

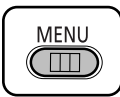

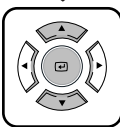
- 

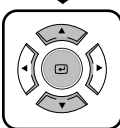
1 Press the **MENU** button.
The main menu is displayed.
- 

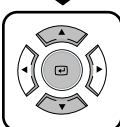
2 Press the **▲** or **▼** button to move to **Picture**.
The **Picture** menu is displayed.
Press the **↵** button.
- 

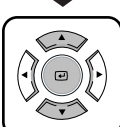
3 Press the **▲** or **▼** button to move to **Custom Picture**, then press the **↵** button.
The **Custom Picture** menu is displayed.
- 

4 Press the **▲** or **▼** button to move to **Gamma**, then press the **↵** button.
- 

5 Press the **▲** or **▼** button to move to desired mode, then press the **↵** button.
Setup is switched to the selected mode.
- 

6 Press the **EXIT** button to exit the menu.

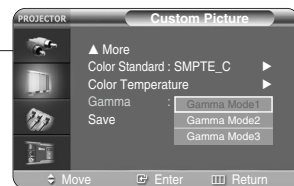
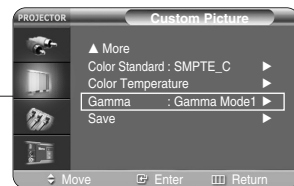
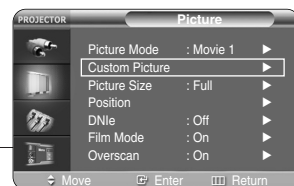

NOTE

Refer to page 30 for information on Gamma Mode1, 2, and 3.

Saving Custom Picture Settings

Used to save custom picture (**Contrast, Brightness, Sharpness, Color, Tint, Color Temperature and Gamma**) settings.

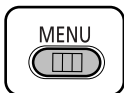
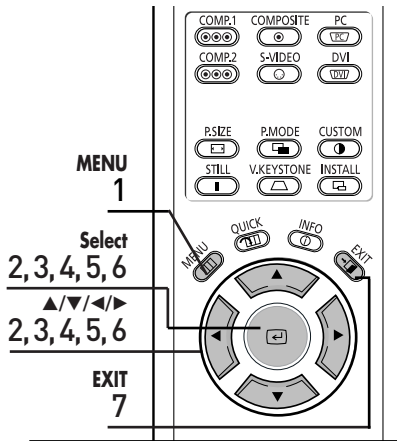

1 Press the **MENU** button.
The main menu is displayed.



2 Press the **▲** or **▼** button to move to **Picture**.
The **Picture** menu is displayed.
Press the **◀** button.

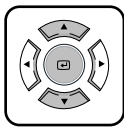

3 Press the **▲** or **▼** button to move to **Custom Picture**, then press the **◀** button.
The **Custom Picture** menu is displayed.

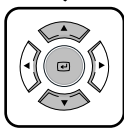

4 Press the **▲** or **▼** button to move to **Save**, then press the **◀** button.
The **Save** menu is displayed.



5 Press the **▲** or **▼** button to move to desired mode, then press the **◀** button.



6 Press the **◀** or **▶** button to move to **OK**, then press the **◀** button.
Setup is switched to the selected mode.

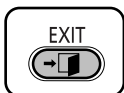

7 Press the **EXIT** button to exit the menu.

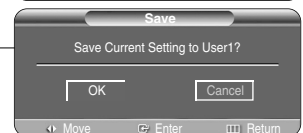
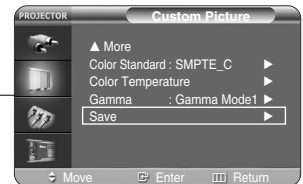
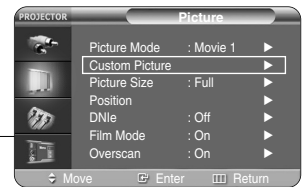

The User1, User2 and User3 modes are saved differently according to external input sources (Component1/ Component2/ S-Video/Composite/PC/DVI).

Setting up DNle

DNle (Digital Natural Image engine) is an image enhancing function developed by Samsung Electronics. It enables users to enjoy brighter, sharper and more dynamic pictures.

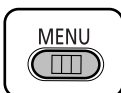
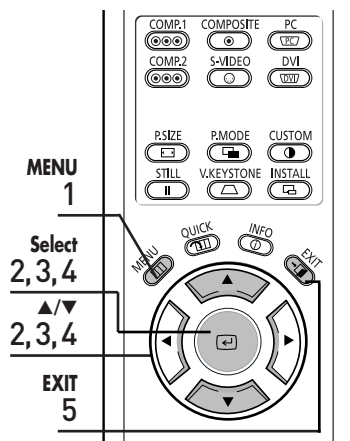

1 Press the **MENU** button.
The main menu is displayed.

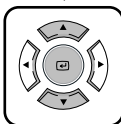

2 Press the **▲** or **▼** button to move to **Picture**.
The **Picture** menu is displayed.
Press the **←** button.

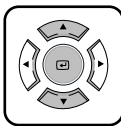

3 Press the **▲** or **▼** button to move to **DNle**, then
press the **←** button.

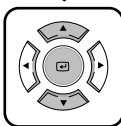

4 Press the **▲** or **▼** button to move to **On**, then
press the **←** button.
Setup is switched to the selected mode.



5 Press the **EXIT** button to exit the menu.

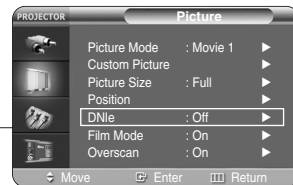

DNle Mode

Off	DNle Mode Off
Demo	DNle On/Off Picture Comparison Mode
On	DNle Mode On

Selecting Picture Size

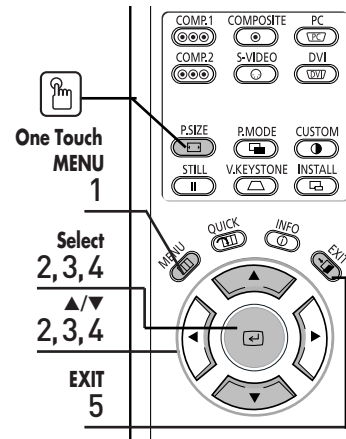

Press the **P.SIZE** button.

Each press of the button, picture size is switched to **Full**, **Zoom1**, **Zoom2** and **4:3**.

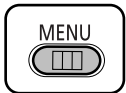

1 Press the **MENU** button.
The main menu is displayed.

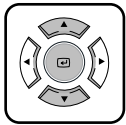

2 Press the **▲** or **▼** button to move to **Picture**.
The **Picture** menu is displayed.
Press the **↵** button.

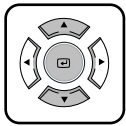

3 Press the **▲** or **▼** button to move to **Picture Size**,
then press the **↵** button.



4 Press the **▲** or **▼** button to move to desired mode,
then press the **↵** button.
Setup is switched to the selected mode.

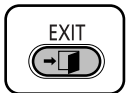

5 Press the **EXIT** button to exit the menu.

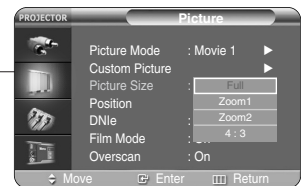
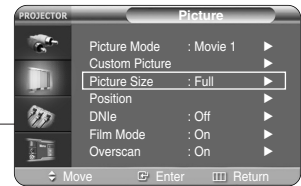

Supported Picture Sizes

O : Supported Modes X : Unsupported Modes

Input			Picture Size			
Source	Signal	Mode	Full	Zoom1	Zoom2	4:3
DVI	HD	1080i	O	X	X	O
		720p	O	X	X	X
		576p	O	O	X	O
		480p	O	O	X	O
	PC	16:9 Mode	O	X	X	X
		4:3 Mode	O	X	X	O
PC (D-Sub)	HD	1080i	O	X	X	O
		720p	O	X	X	X
		576p	O	O	X	O
		480p	O	O	X	O
	PC	16:9 Mode	O	X	X	X
		4:3 Mode	O	X	X	O
Component	HD	1080i	O	X	X	O
		720p	O	X	X	O
		576p	O	O	X	O
		480p	O	O	X	O
	SD	576i	O	O	O	O
		480i	O	O	O	O
Composite & S-Video	SD	480i	O	O	O	O



Refer to page 58 for display modes supported.

NOTE

Screen Position Adjustment

Adjust the screen position if the edges are not aligned.

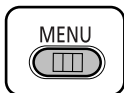
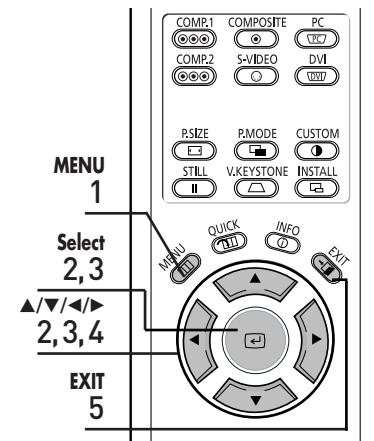

1 Press the **MENU** button.
The main menu is displayed.

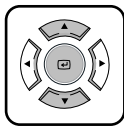

2 Press the **▲** or **▼** button to move to **Picture**.
The **Picture** menu is displayed.
Press the **◀** button.

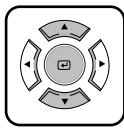

3 Press the **▲** or **▼** button to move to **Position**,
then press the **◀** button.

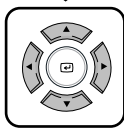

4 Press the **▲**, **▼**, **◀**, or **▶** buttons to adjust the
position.
The Screen is moved and set in the selected position.

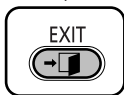

5 Press the **EXIT** button to exit the menu.

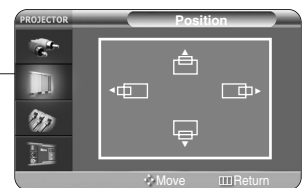
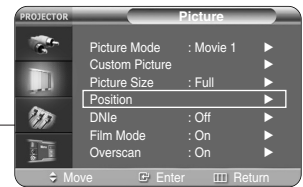

NOTE

The respective position information is set and stored automatically to the corresponding external input modes (Component1,2 / S-Video, Composite / PC / DVI).

Film Mode

Supports enhanced screen quality for films of 24 frames.

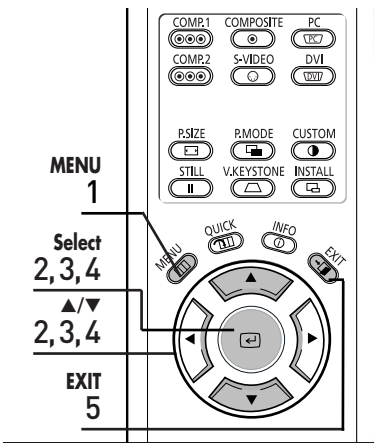

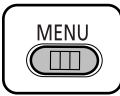
- 

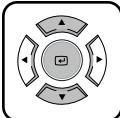
1 Press the **MENU** button.
The main menu is displayed.
- 

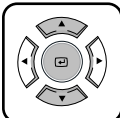
2 Press the **▲** or **▼** button to move to **Picture**.
The **Picture** menu is displayed.
Press the **↵** button.
- 

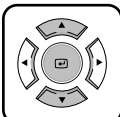
3 Press the **▲** or **▼** button to move to **Film Mode**,
then press the **↵** button.
- 

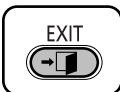
4 Press the **▲** or **▼** button to move to **On**, then
press the **↵** button.
Setup is switched to the selected mode.
- 

5 Press the **EXIT** button to exit the menu.

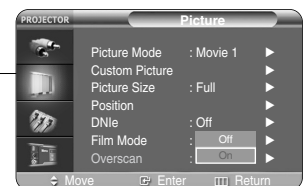
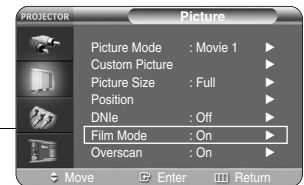

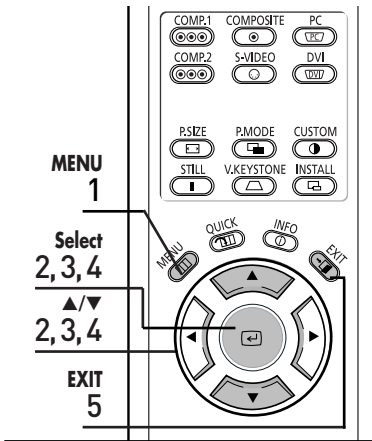

Overscan

Used to display raw input signals from 480p, 576p, 720p, 1080i HD sources or scale to fit to 1280 x 720 resolution after cutting out certain boundaries using software scaling.

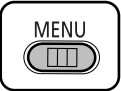

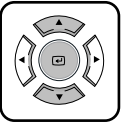
- 

1 Press the **MENU** button.
The main menu is displayed.
- 

2 Press the **▲** or **▼** button to move to **Picture**.
The **Picture** menu is displayed.
Press the **◀** button.
- 

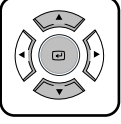
3 Press the **▲** or **▼** button to move to **Overscan**, then press the **◀** button.
- 

4 Press the **▲** or **▼** button to move to **On**, then press the **◀** button.
Setup is switched to the selected mode.
- 

5 Press the **EXIT** button to exit the menu.

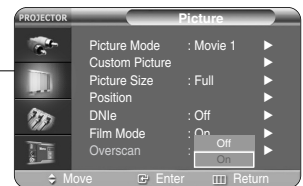
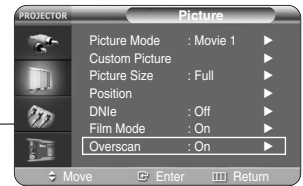

Still Picture

Used to pause playback to see a still picture.

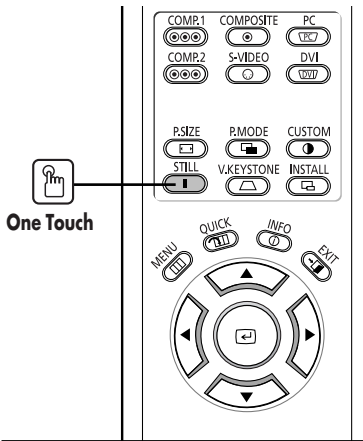

Press the **STILL** button.

Each press of the button pauses and resumes play back.

Setup

Flipping/Reversal of Projected Image	44
Light Setting	45
Correcting Vertical Keystone	46
Test Patterns	47
Restoring the Factory Default Settings	48
Information	49

Flipping/Reversing the Projected Image

To support positioning of the projector, horizontal/vertical flipping and picture reversal are available.

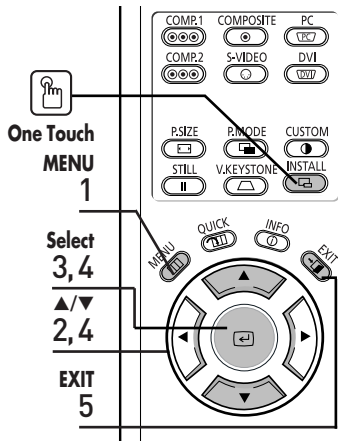

Press the **INSTALL** button.

The screen will flip over horizontally or vertically with each press of the button.

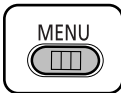
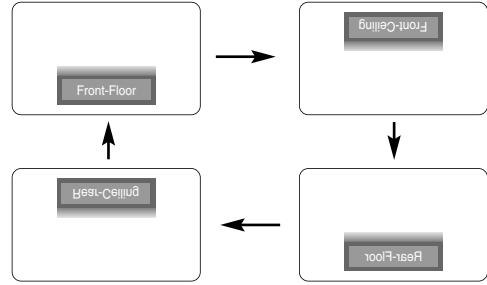

1 Press the **MENU** button.
The main menu is displayed.

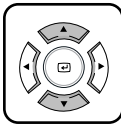

2 Press the **▲** or **▼** button to move to **Setup**.
The **Setup** menu is displayed.

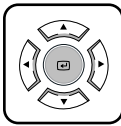

3 Press the **←** button.
Install is selected.

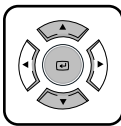

4 Press the **←** button again.
Press the **▲** or **▼** button to move to desired mode, then press the **←** button.
Setup is switched to the selected mode.

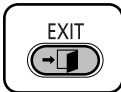

5 Press the **EXIT** button to exit the menu.

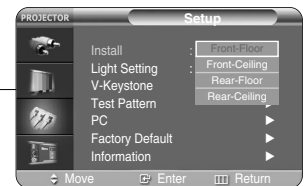
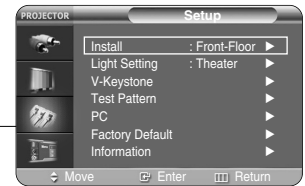

Install Menu

Front-Floor	Normal Image
Front-Ceiling	Horizontally Reversed Image
Rear-Floor	Vertically Reversed Image
Rear-Ceiling	Horizontal/Vertical Reversed Image



NOTE

This function is used to set up reversed image projection for ceiling installation. To install projector, refer to page 14.

Light Setting

Used to set the image brightness by adjusting the amount of light generated by the lamp.

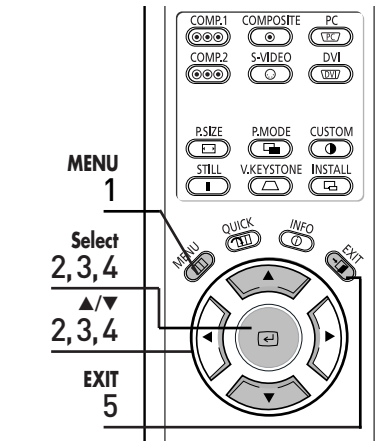

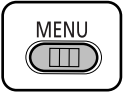
- 

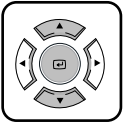
1 Press the **MENU** button.
The main menu is displayed.
- 

2 Press the **▲** or **▼** button to move to **Setup**.
The **Setup** menu is displayed.
Press the **←** button.
- 

3 Press the **▲** or **▼** button to move to **Light Setting**, then press the **←** button.
The **Light Setting** menu is displayed.
- 

4 Press the **▲** or **▼** button to move to desired mode, then press the **←** button.
Setup is switched to the selected mode.
- 

5 Press the **EXIT** button to exit the menu.

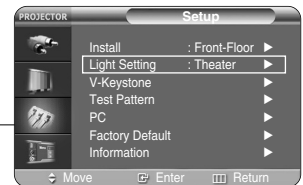



Light Setting Mode

Theater	Used to reduce the brightness of the lamp in dark ambient light to prevent reflection in the eye. It also lowers power consumption and extends the life of the lamp.
Bright	Used to enhance the brightness in relatively bright ambient light.

Correcting Vertical Keystone

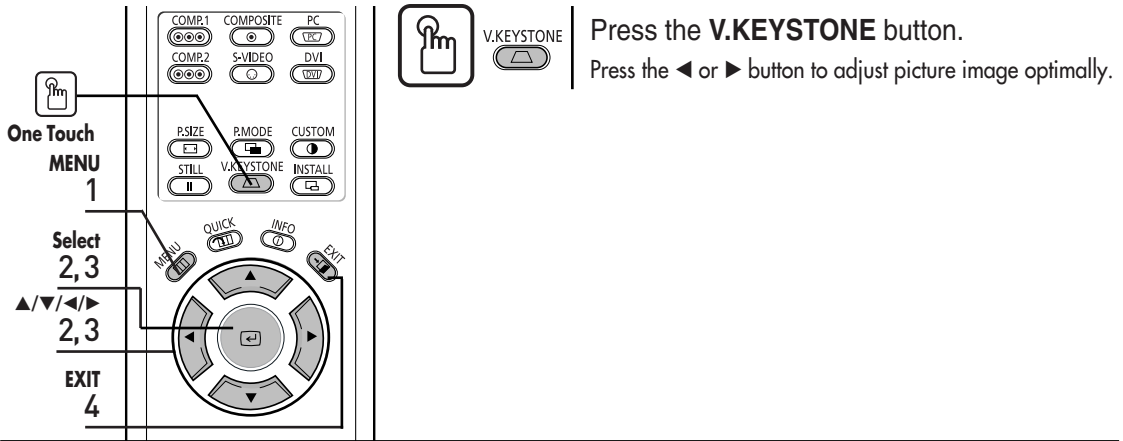
Used to compensate image shape when image distortion occurs.

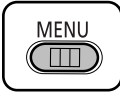
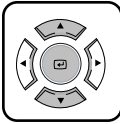
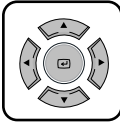

-  **1** Press the **MENU** button.
The main menu is displayed.
-  **2** Press the ▲ or ▼ button to move to **Setup**.
The **Setup** menu is displayed.
Press the ◀ button.
-  **3** Press the ▲ or ▼ button to move to **V-Keystone**,
then press the ◀ button.
Press the ◀ or ▶ button to adjust.
-  **4** Press the **EXIT** button to exit the menu.



NOTE V-Keystone corrects distortion of picture image by software. It is better to install the projector properly to avoid distortion instead of using the V-Keystone feature.

Test Patterns

Generated by the projector itself. Utilized as installation basis for better installation of the projector.

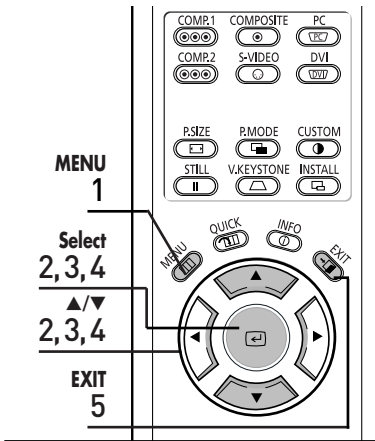

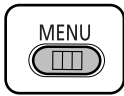
- 

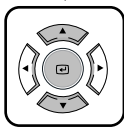
1 Press the **MENU** button.
The main menu is displayed.
- 

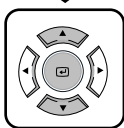
2 Press the **▲** or **▼** button to move to **Setup**.
The **Setup** menu is displayed.
Press the **↵** button.
- 

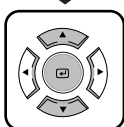
3 Press the **▲** or **▼** button to move to **Test Pattern**,
then press the **↵** button.
The **Test Pattern** menu is displayed.
- 

4 Press the **▲** or **▼** button to move to desired
pattern, then press the **↵** button.
The selected pattern is displayed.
- 

5 Press the **EXIT** button to exit the menu.

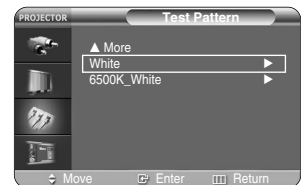
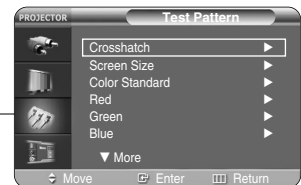
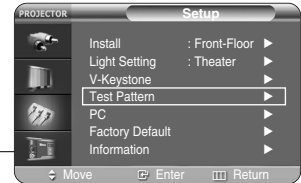

Test Pattern Menu

Crosshatch	You can check whether the picture is distorted or not.
Screen Size	You can refer to picture format sizes such as 1.33:1 or 1.78:1.
Color Standard	You can see the change in colours by switching between SMPTE_C, HD and EBU Colour Standards. Refer to page 32.
Red	Red Screen, only for color adjustment.
Green	Green Screen, only for color adjustment.
Blue	Blue Screen, only for color adjustment.
White	White Screen, only for color adjustment.
6500K_White	White Screen, shows brightest white color possible.



NOTE The Crosshatch and Screen Size patterns of this projector are provided by JKP (JK Production).

The Red/Green/Blue colors of the test patterns are only for the color adjustment procedures, and may not comply with the actual colors displayed during video playback.

Restoring the Factory Default Settings

Used to restore setting values to factory defaults.

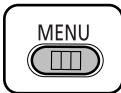
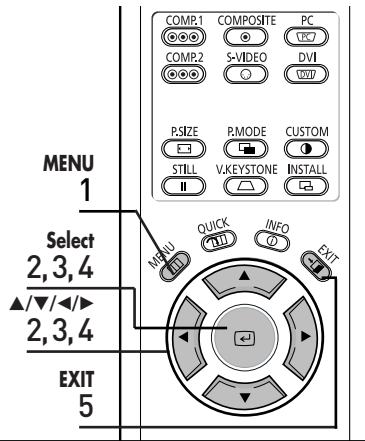

1 Press the **MENU** button.
The main menu is displayed.

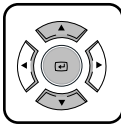

2 Press the **▲** or **▼** button to move to **Setup**.
The **Setup** menu is displayed.
Press the **↵** button.

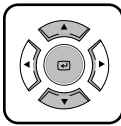

3 Press the **▲** or **▼** button to move to **Factory Default**, then press the **↵** button.

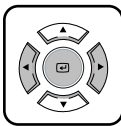

4 Press the **◀** or **▶** button to move to **OK**, then press the **↵** button.
Setting values are returned to factory defaults.



5 Press the **EXIT** button to exit the menu.

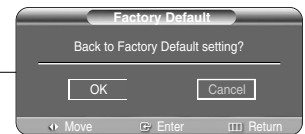
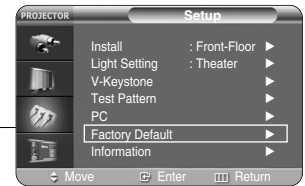

NOTE

User settings including Edit Name and Custom Picture will be reset.

Information

You can check external source signals, picture setup, PC picture adjustment and lamp use time.

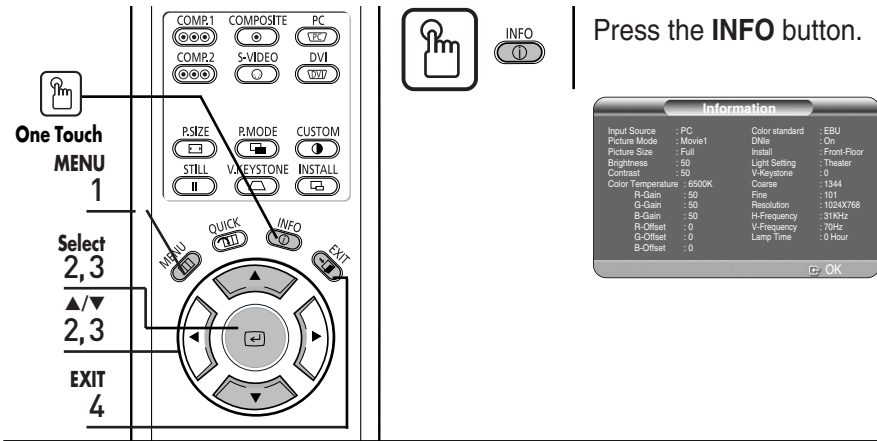

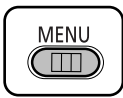
- 

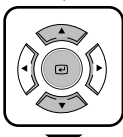
1 Press the **MENU** button.
The main menu is displayed.
- 

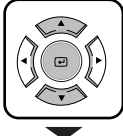
2 Press the **▲** or **▼** button to move to **Setup**.
The **Setup** menu is displayed.
Press the **←** button.
- 

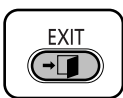
3 Press the **▲** or **▼** button to move to **Information**,
then press the **←** button.
You can check external source signals, picture setup, PC picture adjustment and lamp use time.
- 

4 Press the **EXIT** button to exit the menu.

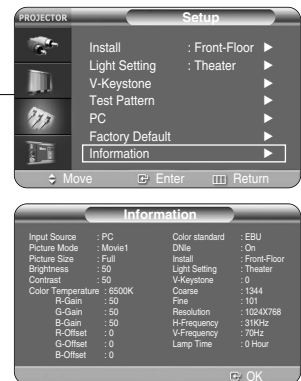

Menu Option

Setting the Language	52
Setting the Menu Position.....	53
Setting the Menu Translucency	54
Setting the Menu Display Time.....	55
Selecting the Quick Menu	56

Setting the Language

You can select the language used for the menu screen.

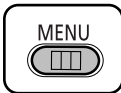
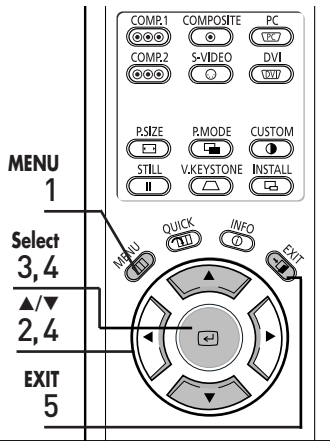

1 Press the **MENU** button.
The main menu is displayed.

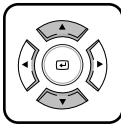

2 Press the **▲** or **▼** button to move to **Menu Option**.
The **Menu Option** menu is displayed.

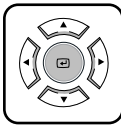

3 Press the **↵** button.
The **Language** is selected.

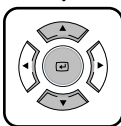

4 Press the **↵** button again.
Press the **▲** or **▼** button to move to desired language, then press the **↵** button.
Setup is switched to the selected language.

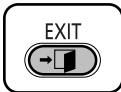

5 Press the **EXIT** button to exit the menu.

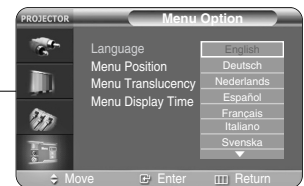

Setting the Menu Position

You can move Menu Position to up/down/left/right.

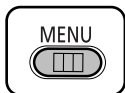
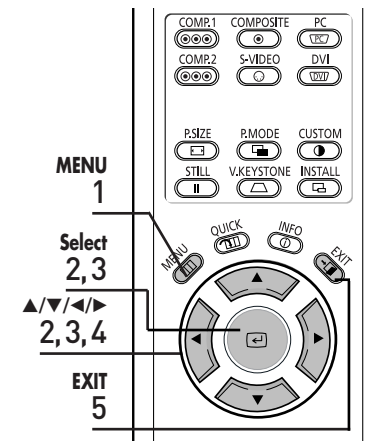

1 Press the **MENU** button.
The main menu is displayed.

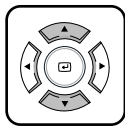

2 Press the **▲** or **▼** button to move to **Menu Option**.
The **Menu Option** menu is displayed.
Press the **↵** button.

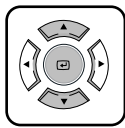

3 Press the **▲** or **▼** button to move to **Menu Position**, then press the **↵** button.

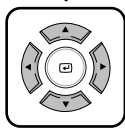

4 Press the **▲**, **▼**, **◀**, or **▶** button to move to desired position.
The menu screen is displayed on the given position.

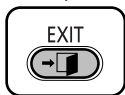

5 Press the **EXIT** button to exit the menu.

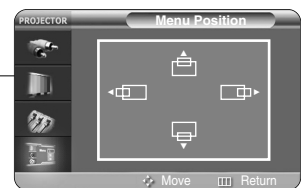

Setting the Menu Translucency

You can set the translucency of menu.

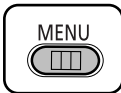
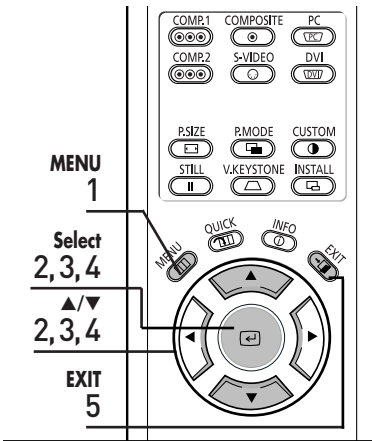

1 Press the **MENU** button.
The main menu is displayed.

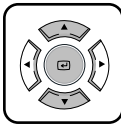

2 Press the **▲** or **▼** button to move to **Menu Option**.
The **Menu Option** menu is displayed.
Press the **↵** button.

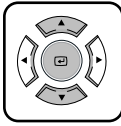

3 Press the **▲** or **▼** button to move to **Menu Translucency**, then press the **↵** button.

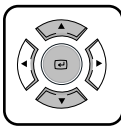

4 Press the **▲** or **▼** button to move to desired mode, then press the **↵** button.
Setup is switched to the selected mode.

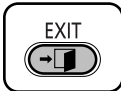

5 Press the **EXIT** button to exit the menu.

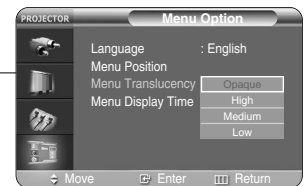

Setting Up the Menu Display Time

You can set the display time of the menu.

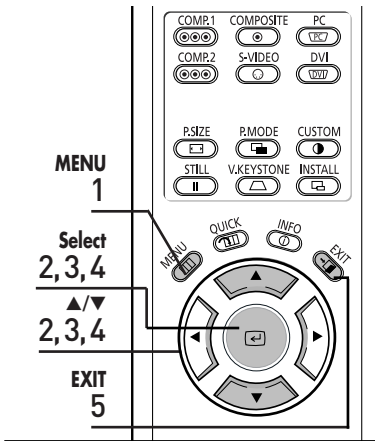

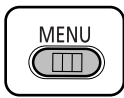
- 

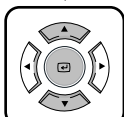
1 Press the **MENU** button.
The main menu is displayed.
- 

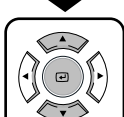
2 Press the **▲** or **▼** button to move to **Menu Option**.
The **Menu Option** menu is displayed.
Press the **↵** button.
- 

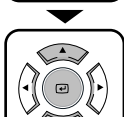
3 Press the **▲** or **▼** button to move to **Menu Display Time**, then press the **↵** button.
- 

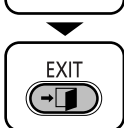
4 Press the **▲** or **▼** button to move to desired time, then press the **↵** button.
Setup is switched to the selected time.
- 

5 Press the **EXIT** button to exit the menu.

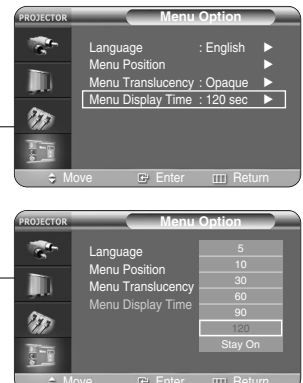

Selecting the Quick Menu

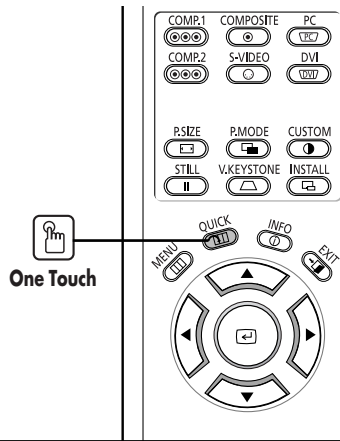

Press the **QUICK** button.
The menu you used previously will appear.

Connecting to PC

Before Connecting to PC	58
Setting up the PC Environment	59
Connecting to PC	60
Automatic Picture Adjustment	62
Frequency Adjustment	63
Fine Tuning with the Phase Adjustment ...	64
Zooming the Screen	65
Reset the PC	66

Before Connecting to PC

Check the following before connecting the projector to a PC.

Check the following before connecting:

- Adjust the PC display setting to the resolution and frequency supported by the projector.
- Refer to the PC user manual (graphic and sound card) when connecting the projector to PC.
- Do not connect power cord until all connections are completed. It may result in damage to the product if you connect power during connection.
- Check the graphic card port type installed in PC.

Display modes supported by this projector

Source	Mode	Resolution (H x V)	Total Resolution	Horizontal Sync		Vertical Sync		Pixel Clock [MHz]	Sync Type		
				Frequency [KHz]	Polarity	Frequency [Hz]	Polarity		Separate	Composite	SOG (Sync-On-Green)
PC & DVI	VGA	640 x 350	800 x 449	31.47	P	70	N	25.175	O	O	X
			832 x 445	37.86	P	85.1	N	31.5	O	O	X
		720 x 400	900 x 449	31.47	N	70	P	28.322	O	O	X
			936 x 446	37.93	N	85	P	35.5	O	O	X
		640 x 480	800 x 525	31.47	N	60	N	25.175	O	O	X
			864 x 525	35.00	N	66.7	N	30.24	O	O	X
			832 x 520	37.86	N	72.8	N	31.5	O	O	X
			840 x 500	37.5	N	75	N	31.5	O	O	X
	832 x 509		43.27	N	85	N	36	O	O	X	
	800 x 600		1024 x 625	35.16	N/P	56.3	N/P	36	O	O	X
	SVGA	800 x 600	1056 x 628	37.88	P	60.3	P	40	O	O	X
			1040 x 666	48.08	P	72.2	P	50	O	O	X
			1056 x 625	46.87	P	75	P	49.5	O	O	X
			1048 x 631	53.67	P	85.1	P	56.25	O	O	X
		832 x 864	1152 x 667	49.73	N	74.6	N	57.284	O	O	X
	XGA	1024 x 768	1344 x 806	48.36	N	60	N	65	O	O	X
1328 x 806			56.4	N	70.1	N	75	O	O	X	
1312 x 800			60.02	P	75	P	78.75	O	O	X	
SXGA	1280 x 1024	1688 x 1066	63.981	P	60.02	P	108	O	X	X	
PC & DVI & Component	HD	1920 x 1080i	2200 x 1125	33.75	X	60	X	74.25	O	X	SOY
			2640 x 1125	28.125	X	50	X	74.25	O	X	SOY
		1280 x 720p	1650 x 750	45	X	60	X	74.25	O	X	SOY
			1980 x 750	37.5	X	50	X	74.25	O	X	SOY
		720 x 480p	858 x 525	31.5	X	60	X	27	O	X	SOY
		720 x 576p	720 x 576	31.25	X	50	X	27	O	X	SOY
Component	SD	720 x 480i	858 x 525	15.73	X	60	X	13.5	O	X	SOY
		720 x 576i	864 x 625	15.625	X	50	X	13.5	O	X	SOY



The table complies to IBM/VESA requirements and is based on analog signal input.

NOTE

Refer to "Rear Side and Cables" on page 10 for cables used for connection.

Setting up the PC Environment

- 1 Click the right mouse button on the Windows wallpaper and click on **Properties**.
Display Properties tab will appear.



- 2 Click on **Settings** tab and set the **Screen resolution** by referring to **Resolution** described in the display mode table supported by this projector.
 - You do not have to change **Color quality** setup.

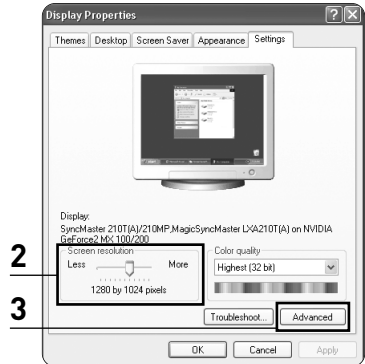

- 3 Press the **Advanced** button.
Another property window will appear.

- 4 Click on **Monitor** tab and set the **Screen refresh rate** by referring to **Vertical Frequency** described in the display mode table supported by this projector.
 - Set up both the vertical and horizontal frequency instead of **Screen refresh rate**.

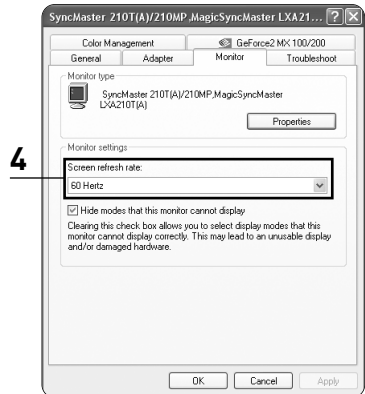

- 5 Press the **OK** button to close the window and press the **OK** button in **Display Properties** window to close.
 - The computer might begin restart automatically.

- 6 Shut down the PC and connect to the projector. (Page 60)



NOTE

- Process might vary depending on the type of computers or Windows versions.
- This appliance supports up to 32 bits per pixel in **Color quality** when it is used as a PC monitor.
- Projected images may differ from the monitor depending on monitor manufacture or Windows versions.
- If a band or an unusual signal appears on the projector when PC is turned off or disconnected, switch to **Composite** mode using the **SOURCE** button or check that PC is properly connected.
- When connecting the projector to PC (including DVI connection), check that PC setup complies to display settings supported by this projector. If not, there may be signal problems.

Connecting to PC

You can connect a PC to the projector and use it as a monitor.

Using PC Video Cable or DVI Cable

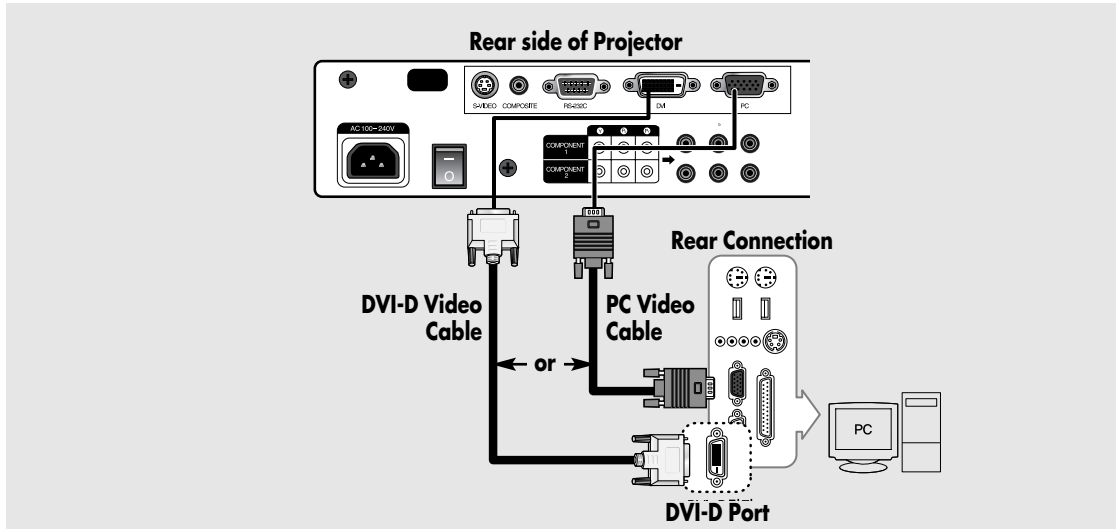

Connect PC (RGB In) port on the rear side of the projector to the monitor output port of PC using PC video cable.

- If PC has a DVI output port, connect it to DVI port of the projector.



This product supports Plug & Play. No driver installation is needed for Windows XP.

NOTE

Viewing the PC Screen

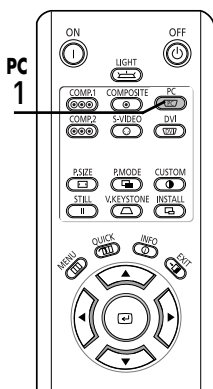

- 1 Turn on the projector and press the PC button to select PC. If the projector is connected to DVI, press the DVI button to select DVI.

- If PC Mode is not available, check PC video cable is in place.

- 2 Turn on the PC and set the PC Environment when necessary. (Page 59)

- 3 Adjust the screen. (Pages 62~65)



NOTE

- Enjoy better picture quality by using DVI-D cable (supports digital signals only) instead of PC Video cable.
- DVI-I cable (supports analog signals) is not supported. Use DVD-D cable.
- Sound comes out from PC speakers.

PC

Pin Configuration of PC Video Port Plug

PC Video Cable (15-pin signal)

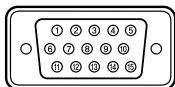

Pin No.	PC Input
1	Red (R)
2	Green (G)
3	Blue (B)
4	Ground
5	Ground (DDC)
6	Red (R) Ground
7	Green (G) Ground
8	Blue (B) Ground
9	Reserved
10	Ground Sync
11	Ground
12	Data (DDC)
13	Horizontal Sync
14	Vertical Sync
15	Clock (DDC)

DVI-D (supports only digital signals)

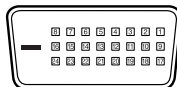

Pin No.	Signal	Pin No.	Signal
1	T.M.D.S. DATA2-	13	T.M.D.S. DATA3+
2	T.M.D.S. DATA2+	14	+5V Power
3	T.M.D.S. DATA2/4 Shield	15	Ground for 5V
4	T.M.D.S. DATA4-	16	Hot Plug Detect
5	T.M.D.S. DATA4+	17	T.M.D.S. DATA0-
6	Clock (DDC)	18	T.M.D.S. DATA0+
7	Data (DDC)	19	T.M.D.S. DATA0/5 Shield
8	No Connection	20	T.M.D.S. DATA5-
9	T.M.D.S. DATA1-	21	T.M.D.S. DATA5+
10	T.M.D.S. DATA1+	22	T.M.D.S. Clock Shield
11	T.M.D.S. DATA1/3 Shield	23	T.M.D.S. Clock+
12	T.M.D.S. DATA3-	24	T.M.D.S. Clock-

VESA Plug & Play

This appliance supports VESA Plug & Play and recognizes connection to PC automatically.



CAUTION

DVI-D cable does not support analog RGB signals.

Automatic Picture Adjustment

Used to adjust frequency and phase of PC screen automatically.

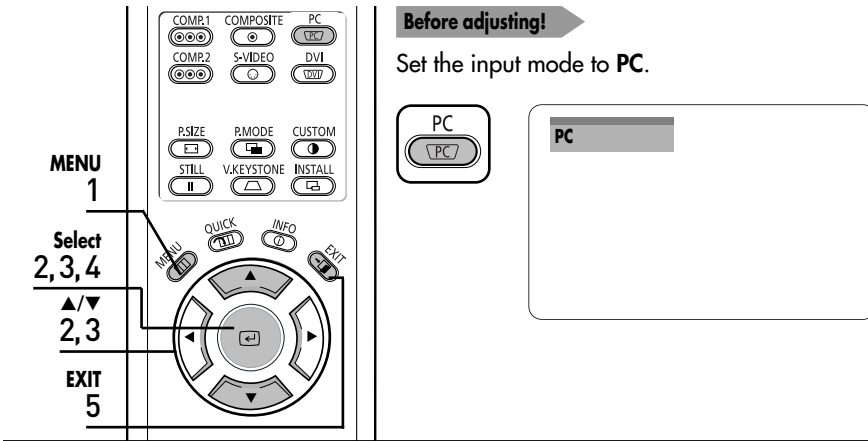

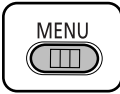
- 

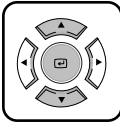
1 Press the **MENU** button.
The main menu is displayed.
- 

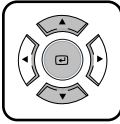
2 Press the **▲** or **▼** button to move to **Setup**.
The **Setup** menu is displayed.
Press the **↵** button.
- 

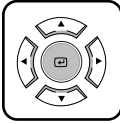
3 Press the **▲** or **▼** button to move to **PC**, then press the **↵** button.
The **Auto Adjustment** is selected.
- 

4 Press the **↵** button.
Auto Adjustment in progress message is displayed and PC screen is adjusted automatically.
- 

5 Press the **EXIT** button to exit the menu.

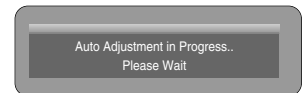
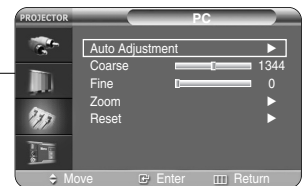
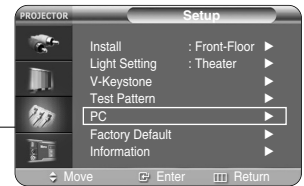

Frequency Adjustment

Used to adjust frequency when vertical lines appear on PC screen.

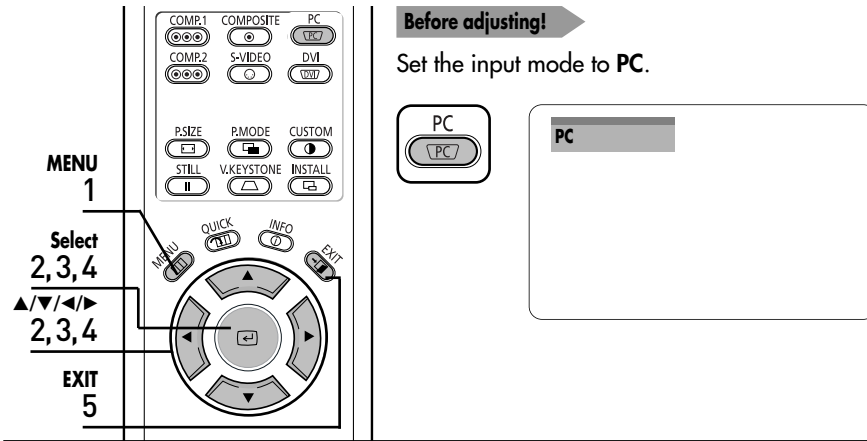

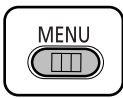
- 

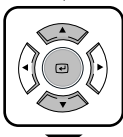
1 Press the **MENU** button.
The main menu is displayed.
- 

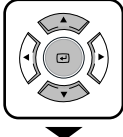
2 Press the **▲** or **▼** button to move to **Setup**.
The **Setup** menu is displayed.
Press the **◀** button.
- 

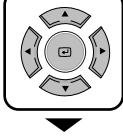
3 Press the **▲** or **▼** button to move to **PC**, then press the **◀** button.
The **PC** menu is displayed.
- 

4 Press the **▲** or **▼** button to move to **Coarse**, then press the **◀** button.
Press the **◀** or **▶** button to adjust.
- 

5 Press the **EXIT** button to exit the menu.



Fine Tuning with the Phase Adjustment

Used to fine tune the PC screen.

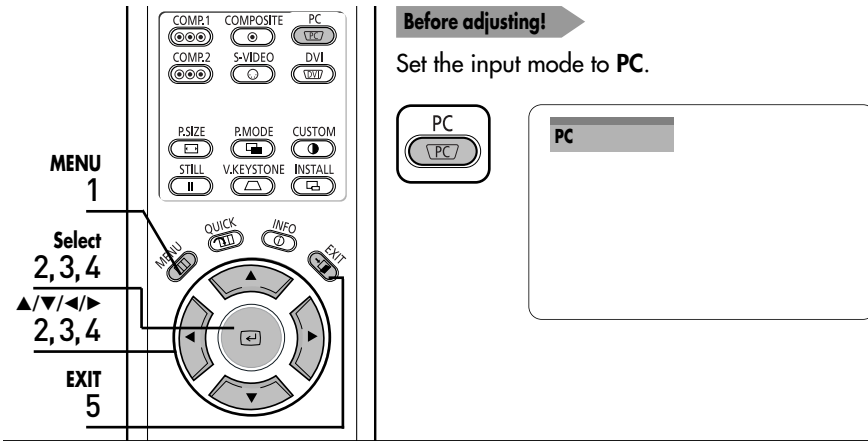

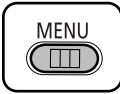
- 

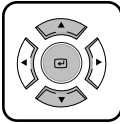
1 Press the **MENU** button.
The main menu is displayed.
- 

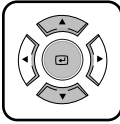
2 Press the **▲** or **▼** button to move to **Setup**.
The **Setup** menu is displayed.
Press the **↵** button.
- 

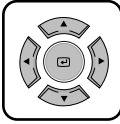
3 Press the **▲** or **▼** button to move to **PC**, then
press the **↵** button.
The **PC** menu is displayed.
- 

4 Press the **▲** or **▼** button to move to **Fine**, then
press the **↵** button.
Press the **◀** or **▶** button to adjust.
- 

5 Press the **EXIT** button to exit the menu.



Zooming the Screen

Used to extend PC screen from the center.

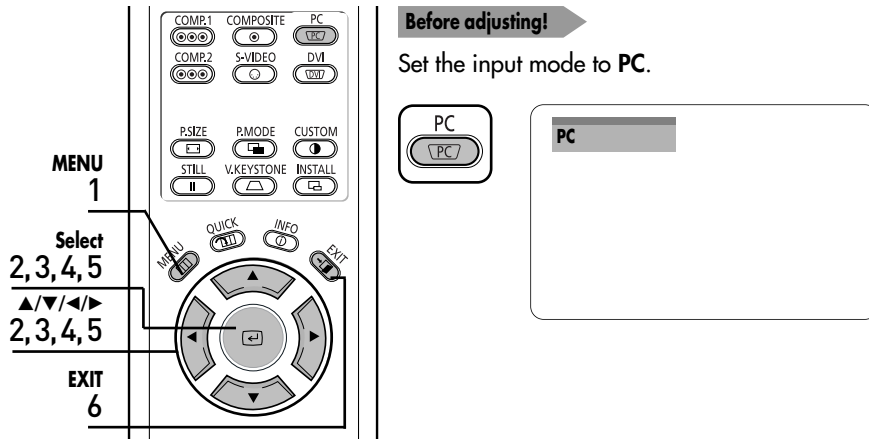

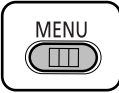

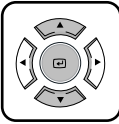
- 

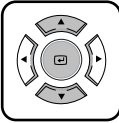
1 Press the **MENU** button.
The main menu is displayed.
- 

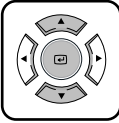
2 Press the **▲** or **▼** button to move to **Setup**.
The **Setup** menu is displayed.
Press the **◀** button.
- 

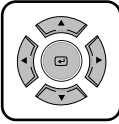
3 Press the **▲** or **▼** button to move to **PC**, then press the **◀** button.
The **PC** menu is displayed.
- 

4 Press the **▲** or **▼** button to move to **Zoom**, then press the **◀** button.
- 

5 Press the **▲**, **▼**, **◀**, or **▶** button to move to desired position, then press the **◀** button to extend as you want.
The screen can be extended by **1, 2, 4, or 8 times**.
- 

6 Press the **EXIT** button to exit the menu.

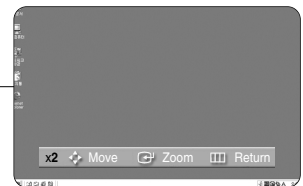
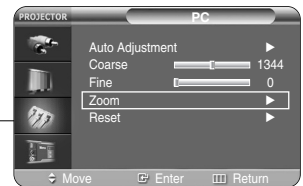

Reset the PC

Used to reset PC mode settings to the Factory Default values.

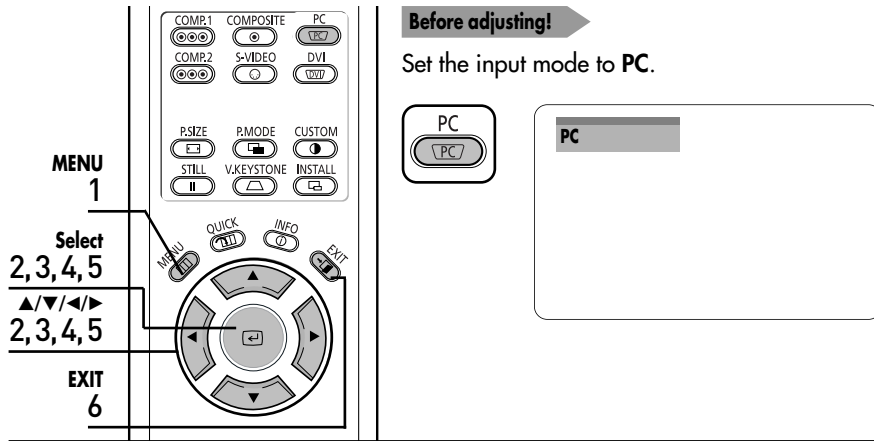

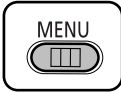

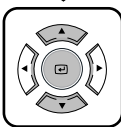
- 

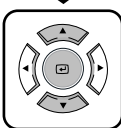
1 Press the **MENU** button.
The main menu is displayed.
- 

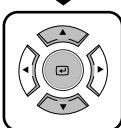
2 Press the **▲** or **▼** button to move to **Setup**.
The **Setup** menu is displayed.
Press the **↵** button.
- 

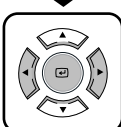
3 Press the **▲** or **▼** button to move to **PC**, then
press the **↵** button.
The **PC** menu is displayed.
- 

4 Press the **▲** or **▼** button to move to **Reset**, then
press the **↵** button.
- 

5 Press the **◀** or **▶** button to move to **OK**, then
press the **↵** button.
The PC is reset to the time of purchasing.
- 

6 Press the **EXIT** button to exit the menu.

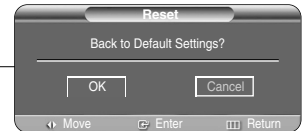
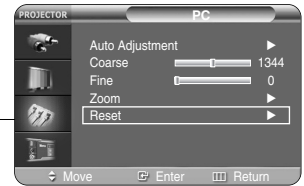

Troubleshooting

Before Contacting Service Personnel.....68

Before Contacting Service Personnel

If this projector does not operate properly, check the following first.
If the problem is continues, contact your dealer.



Installation and Connection

Symptoms	Troubleshooting	Note
No Power.	Be sure that the power cord in place and the power switch on the rear side of the projector is turned on "—".	Page 15
Image is distorted or trapezoidal.	Be sure to make the projection beam perpendicular to the screen and adjust the focus using the Zoom Knob and the Focus Ring. Avoid to use the V-Keystone function if possible.	Pages 16~20
Want to install projector on ceiling.	Ceiling bracket is an optional accessory. Please contact your dealer.	
Image is distorted or trapezoidal.	Be sure that the connection cable (video) is properly connected to the proper port. Unless they are connected properly, the device is not available.	Pages 23~25



Menu and Remote Control

Symptoms	Troubleshooting	Note
Remote control does not work.	<ul style="list-style-type: none"> ■ Be sure that the proper external source is selected. ■ Check batteries of the remote control. If there is a problem, replace them with recommended ones. ■ Check the angle and distance between the remote control and the projector. Be sure that there is no obstacle between the projector and the remote control that may block the signal. ■ Direct lighting of 3-way light bulbs or other lighting device on the remote sensor of the projector may affect the sensitivity and cause the remote control to malfunction. 	<p>Page 26</p> <p>Page 12</p> <p>Page 13</p>
Some of Menu functions do not work.	Refer to the user manual. Some functions are locked depending on sources and type of the input signal.	Pages 23~26

Screen and External Source

Symptoms	Troubleshooting	Note
Cannot see picture images.	<ul style="list-style-type: none"> ■ Be sure that the power cord of the projector is in place. ■ Be sure that the proper input source is selected. ■ Be sure that cable is properly connected to the rear panel of the projector. ■ Check the Remote Control batteries. ■ Be sure that the Color, Brightness settings are not at their lower limit. 	<p>Page 15</p> <p>Page 26</p> <p>Pages 23~25</p> <p>Page 12</p> <p>Page 31</p>
Poor color.	Adjust the Color and Brightness .	Page 31
Images are not clear.	<ul style="list-style-type: none"> ■ Adjust the focus. ■ Check that the projection distance is either too far or too near to the screen. 	<p>Page 16</p> <p>Page 19~20</p>
Strange noise.	Contact your service personnel if the noise continues due to defective parts.	
Repair indicator is on.	Refer to instructions on lamp and repair.	Page 9
Lines appear on screen.	Noisy lines may appear for PC mode in case of frequency discrepancy. Adjust the vertical frequency of your video card on the advanced display property.	Page 63
Green appears on the screen.	Be sure to properly connect the external devices. Especially, connect the component (Y, Pb, Pr) cables matching the color codes.	Pages 23~25
Cannot see the picture from the external devices.	Be sure that the proper operation of the external device. Adjustable items of the Custom Picture Menu are properly set.	Pages 26, 31
Only blue screen appears.	Be sure to properly connect the external devices. Check the connection cables again.	Pages 26, 23~25
Screen appears in black and white or odd color/screen is too dark or bright.	<ul style="list-style-type: none"> ■ Adjustable items of the Custom Picture Menu are properly set. ■ Execute Factory Default if you want to restore the factory default setting values. 	<p>Page 31</p> <p>Page 48</p>

Other Information

Storage and Maintenance	72
Purchasing Optional Parts	73
Structure of Screen Menu	74
Lamp Replacement	77
RS-232C Connection and Control	78
Specifications	80
Remote Control Specifications	81

Storage and Maintenance

Clean and maintain the projector in the following way.

Cleaning the Projector and Lens

Use a dry soft cloth.

- Do not use flammable materials such as benzene and thinner. Do not use a wet cloth. It may result in malfunction.
- Do not clean the lens using a fingertip or a sharp object. It may leave scratches.

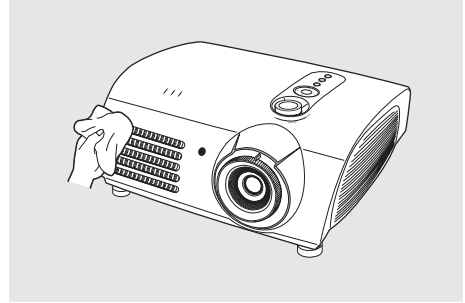

Cleaning the Inside of the Projector

Contact your dealer or service personnel to clean the inside of the projector.

Contact your dealer if particles or other objects are stuck inside of the projector.

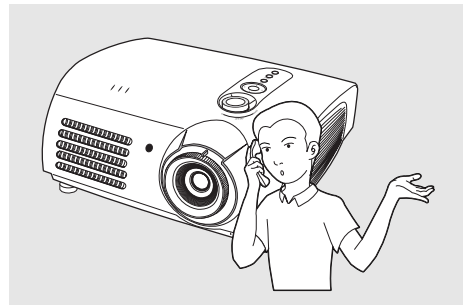

Purchasing Optional Parts

Information for purchasing accessories or optional parts.

Optional Parts

DVI-D Cable

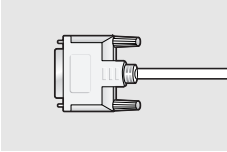

You can purchase at electronics shops or over the Internet.

Video (Composite) Cable

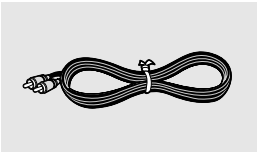

S-Video Cable



Component Cable

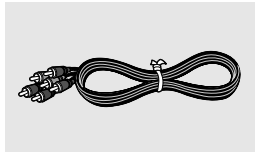

PC Video Cable



1.5V AAA Batteries

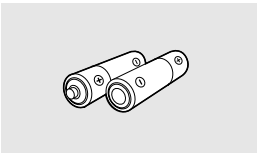

You can purchase at electronics shops or over the Internet.
Or you can call your dealer or service center.

Structure of Screen Menu

You can see the entire structure of screen menu.

Buttons used for Screen Menu



Open Menu/Exit Menu



Select an item/change setting value

Select Composite/S-Video/Component Input Mode



Input

- Source List** — Component1 / Component2 / S-Video / Composite / PC / DVI
- Edit Name** — Component1 / Component2 / S-Video / Composite / PC / DVI (Selected without Input)
VCR / DVD / Cable / Satellite / AV Receiver / DVD Receiver / Game
Camcorder / Combo / PC

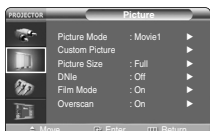

Picture

- Picture Mode** — Dynamic / Standard / Movie1 / Movie2 / User1 / User2 / User3 / Custom
- Custom Picture**
 - Contrast** 0 ~ 100
 - Brightness** 0 ~ 100
 - Sharpness** 0 ~ 100
 - Color** 0 ~ 100
 - Tint** 0 ~ 100 (Not supported in 480p mode or above)
 - Color Standard** SMPTE_C/HD/EBU
 - Color Temperature** 5500K / 6500K / 8000K / 9300K
 - Gamma** Gamma Mode1 / Gamma Mode2 / Gamma Mode3
 - Save** User1 / User2 / User3

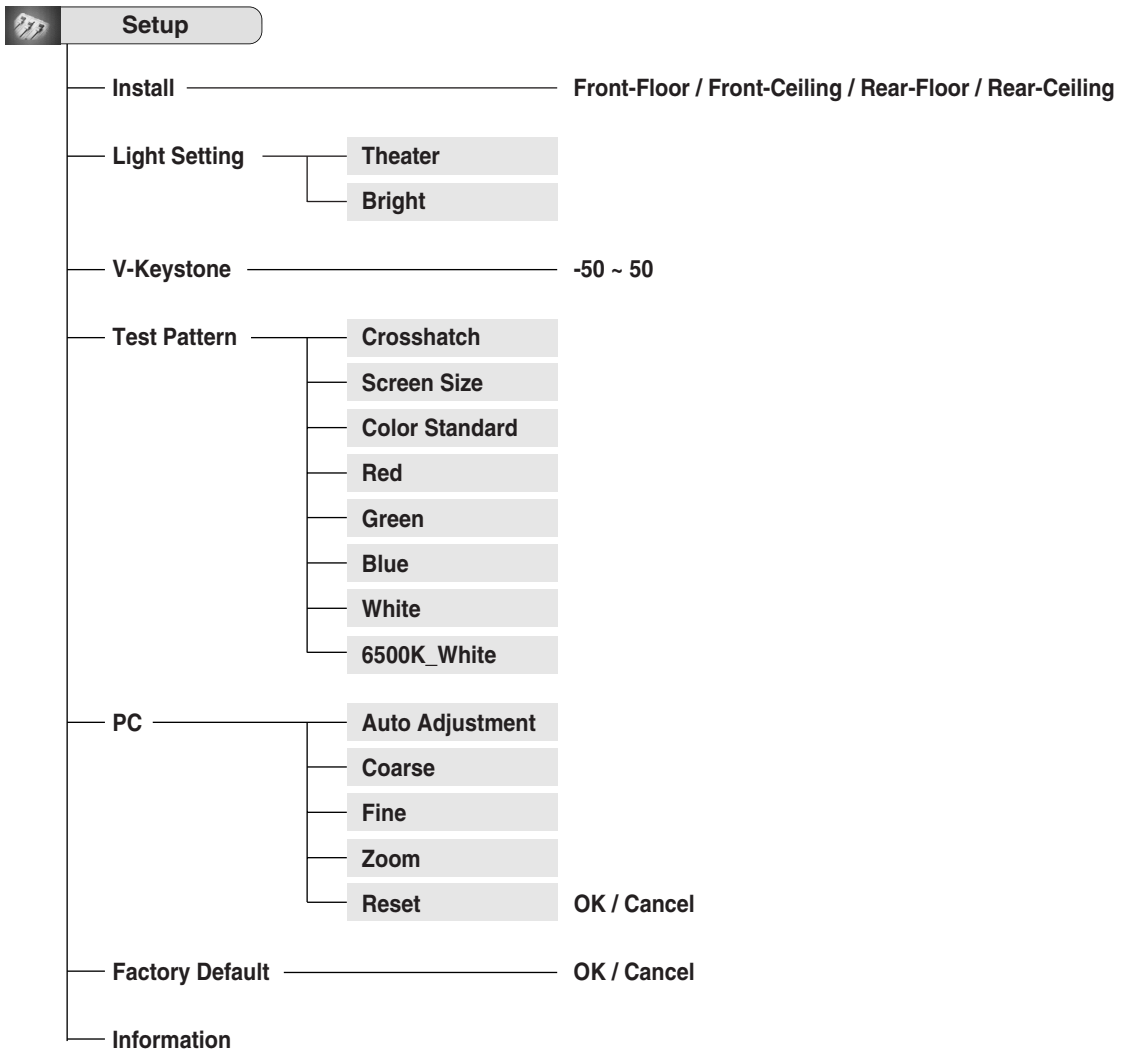
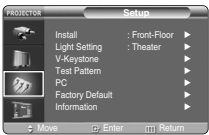
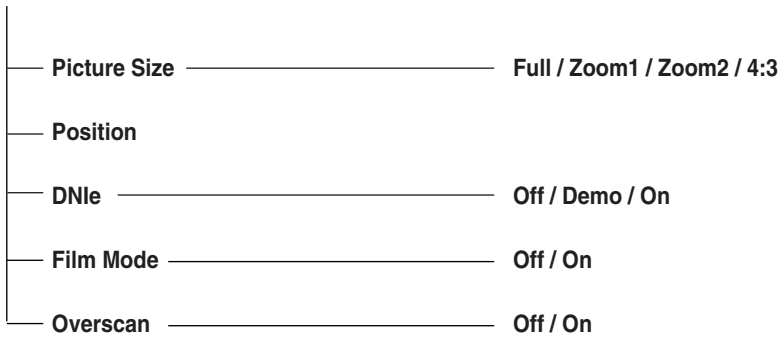

Structure of Screen Menu (Continued)

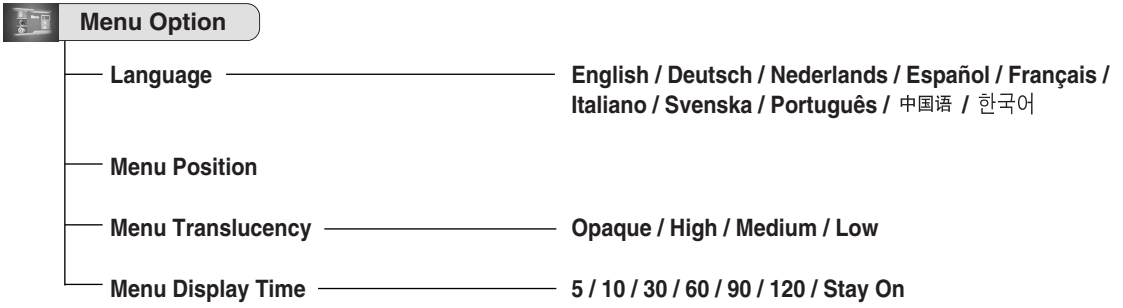

Lamp Replacement

Cautions on Lamp Replacement

- Projector lamp requires replacement after.
- Use the recommended lamp when replacing. Lamp specifications are defined in the user's manual. Replace with the same model provided with the projector.
 - Lamp Model Name : LAMP-MERCURY-Philips
 - Lamp Manufacture : Philips Lighting
 - Lamp Life Time : 2000Hrs
 - Lamp Type : 250W UHP
 - Lamp Part Number : BP47-00010A
- Check that the power cord is unplugged before replacing lamps.
- Wait for at least 30 minutes before replacing lamps to cool off the lamp unit after disconnecting power.
- Lamp is a high-pressure product. Do not place near flammable materials or children.
- Remove dirt or foreign materials around or inside the lamp unit using a proper vacuum device.
- Be careful not to touch the lamp itself when handling the lamp unit.
- If the lamp is poorly handled, it may result in poor picture quality or shorter life time of lamp.
- The projector will not operate normally if the cover is not locked completely after lamp replacement. Refer to LED information in the user's manual if the projector does not operate normally.

Lamp Replacement Procedure

- 1 Detach the screw of the lamp cover.

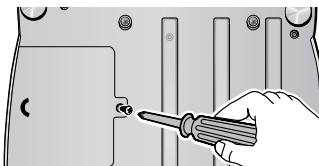

- 2 Push to open the lamp cover in the direction of the arrow.

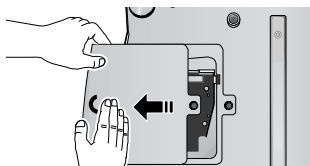

- 3 Detach the three screws.

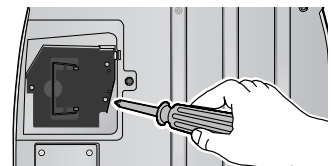

- 4 Lift and grip the lamp handle in the direction of the arrow and pull it out.

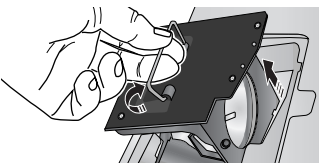

- 5 Reverse the disassembly procedure to assemble the unit after replacement.



NOTE

- The Lamp is high-temperature high-pressure product. Wait for at least 30 minutes to proceed after disconnecting power.
- Be sure that the power cord is disconnected before proceeding.

RS-232C Connection and Control

Connecting the Projector to a PC

You can connect the Projector to a PC using the RS-232C (Crossed, Female Type) cable to control the projector.

- Do not disconnect or connect the RS-232C cable while the Computer or the Projector is operating. It may cause serious damage to the Computer or the Projector.
- If the PC is not properly configured, the RS-232C connection may not work properly. For further details, refer to the Computer's product documentation.

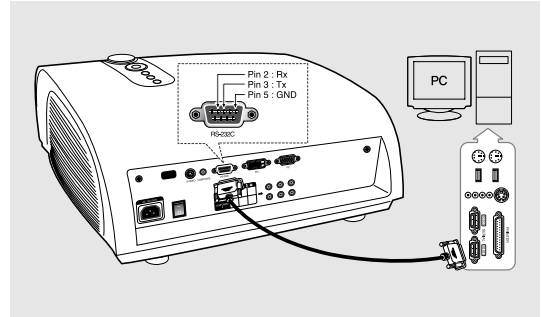

Communication Format (Complies with the RS232C Standard)

- Transmission Speed: 115,200 bps
- Parity Bit: No
- Data Length: 8 data bits, 1 stop bit

Transmission Sequence and Data Format

Transmission Sequence

Argument 1 → Argument 2 → -----
Argument N, Command, Response

Structure for Variables (8 bytes)

0x08	0x11	N	PN	CS
------	------	---	----	----

N : Variable's Number (Hexadecimal)

PN : Value of the Variable
(Implemented in 4 bytes - Hexadecimal)

CS : Checksum
(Boolean complementation of the summation of all bytes except the CS)

Command Structure (4 bytes)

CN	0x12	CC	CS
----	------	----	----

CN : Command + Number of Variables
(Hexadecimal)

CC : Command - Hexadecimal
(Refer to the commands table)

CS : Checksum
(Boolean complementation of the summation of all bytes except the CS)

Command Structure (4 bytes)

- Confirms proper data transmission

CN	0x12	CC	CS
----	------	----	----

- No response for communication errors or invalid commands

- Transmit the following control command to transmit one or more control commands if there was a successful response for the previous transmission or there was no response in over 3 seconds.
- While controlling the Projector using a Computer, you cannot check the Projector's status change using the Computer nor will it be displayed on the Projector's screen. Transmit the INFORMATION command to display the current information on the Projector's screen.
- All the control commands apply to the input source and the Projector's status currently displayed.

Commands

e.g.) DISPLAY → CUSTOM CONFIGURATION → Set the CONTRAST to 60

Parameter 1	0x08	0x11	0x01	0x00	0x00	0x00	0x01	0xE5
Parameter 2	0x08	0x11	0x02	0x00	0x00	0x00	0x03	0xE2
Parameter 3	0x08	0x11	0x03	0x00	0x00	0x00	0x3C	0xA8
Command	0x04	0x12	0x4B	0x9F				
Return	0x03	0x0C	0xF1					

★ : Range is -50 ~ 50, use the Boolean Complementary for negative values.

	Control Items	Command	Parameters	Return	
General	Power	On	76	0,5	
		Off	76	0,3	
		Direct Off	76	0,6	
Input	Input	Component1	76	2,8	
		Component2	76	2,9	
		S-Video	76	2,11	
		Composite	76	2,10	
		PC	76	2,12	
		DVI	76	2,7	
	Check	Component1	77	64,208	1 or 0
		Component2	77	64,209	1 or 0
		S-Video	77	64,210	1 or 0
		Composite	77	64,211	1 or 0
Picture	Picture Mode	Dynamic	75	2,10,0	
		Standard	75	2,10,1	
		Movie1	75	2,10,2	
		Movie2	75	2,10,3	
		User1	75	2,10,4	
		User2	75	2,10,5	
		User3	75	2,10,6	
		Custom	75	2,10,7	
		Custom Picture	Contrast (0-100)	75	1,3,x
			Brightness (0-100)	75	1,4,x
Color Standard	Sharpness (0-100)	75	1,5,x		
		Color (0-100)	75	1,6,x	
	Tint (0-100)	75	1,7,x		
		Color Standard	SMPTE-C	76	1,1,0
	Color Temperature	HD	76	1,1,1	
		EBU	76	1,1,2	
		5500K	75	2,0,3	
		6500K	75	2,0,2	
		8000K	75	2,0,1	
		9300K	75	2,0,0	
Gain	R(0-100)	75	2,3,x		
	G(0-100)	75	2,4,x		
	B(0-100)	75	2,5,x		
	Offset	R(-50-50)	75	2,6,x	
Gamma	GI(-50-50)	75	2,7,x		
	GB(-50-50)	75	2,8,x		
	Gamma Mode1	75	2,1,0		
Picture Size	Gamma Mode2	75	2,1,1		
	Gamma Mode3	75	2,1,2		
	Full	75	2,9,0		
	Zoom1	75	2,9,2		
	Zoom2	75	2,9,3		
	4:3	75	2,9,4		
Position	Up	75	2,13,0		
	Down	75	2,13,1		
	Left	75	2,13,2		
	Right	75	2,13,3		
DNile	On	76	0,1,1		
	Off	76	0,1,0		
	Demo	76	0,1,2		

	Control Items	Command	Parameters	Return
Picture	Film Mode	On	75	2,11,1
		Off	75	2,11,0
		Overscan	75	2,12,1
Setup	Install	On	75	2,12,1
		Off	75	2,12,1
		Front-Floor	75	0,1,0
		Front-Ceiling	75	0,1,1
	Light Setting	Rear-Floor	75	0,1,2
		Rear-Ceiling	75	0,1,3
		Theater	76	0,2,1
	Test Pattern	Bright	76	0,2,0
		Crosshatch	76	0,0,1
		Color Standard	76	0,0,2
Red		76	0,0,3	
Green		76	0,0,4	
Blue		76	0,0,5	
White		76	0,0,6	
6500K_White		76	0,0,7	
V-Keystone		V-Keystone (-50-50)	75	0,3,x
PC		Auto Adjustment	76	6,5
Menu Option	Information	Coarse (0-2000)	76	6,3,x
		Fine (0-255)	76	6,4,x
	Zoom (0-3)	76	6,13,x	
	PC Reset	76	6,14	
	Factory Default	Confirm	76	9
	Information	OK	76	0,2,0
	Language	English	76	10,0,0
		Deutsch	76	10,0,1
		Nederlands	76	10,0,2
		Español	76	10,0,3
Français		76	10,0,4	
Italiano		76	10,0,5	
Svenska		76	10,0,6	
Português		76	10,0,7	
中国語		76	10,0,8	
한국어		76	10,0,9	
Menu Position	Up	76	10,1,0	
	Down	76	10,1,1	
	Left	76	10,1,2	
	Right	76	10,1,3	
Menu Translucency	Opaque	76	10,2,0	
	High	76	10,2,2	
	Medium	76	10,2,4	
Menu Display Time	Low	76	10,2,6	
	Stay On	76	10,3,6	
	5	76	10,3,0	
	10	76	10,3,1	
	30	76	10,3,2	
	60	76	10,3,3	
Menu	90	76	10,3,4	
	120	76	10,3,5	
	EXIT	76	0,4	

Specifications

Design and specifications of the product may be modified without prior notice for better performance. This appliance is Class B device that can be used in both residential and industrial areas.

Classification		Model	SP-H700/H710	SP-H500
Panel	Size		0.8"(HD2+)	0.63"(ED2)
	Resolution		1280 x 720	1024 x 576
Lamp	Type		250W UHP	
	Life Time		2000Hrs	
Power	Power Consumption		350W	
	Voltage		AC 100-240V	
	Frequency		50/60Hz	
Dimensions			384 x 425 x 177 mm / 15.1" x 16.7" x 7.0"	
Weight			9.0 kg / 19.8 lb	
Accessories			Owner's Instructions, Power Cord, Remote control, Batteries	
Key Features	Brightness		700 ANSI	600 ANSI
	Contrast (Theatre Mode)		2800 : 1	2000 : 1
	Screen Size		Diagonal 30.385~300"	Diagonal 40~200"
	Projection Range		1.0 ~ 13.6 m / 3.4 ~ 44.8 ft	1.3 ~ 8.8 m / 4.4 ~ 28.5 ft
	Keystone		Vertical	
Input/Output	DVI	1) Connector Type: DVI-D		
		2) Available Format: PC - VGA~SXGA DTV - 480p, 576p, 720p, 1080i		
		3) Frequency: Refer to page 63.		
	PC	1) Connector Type: 15Pin D-Sub		
		2) Frequency: Refer to page 63.		
	Component 1 Component 2	1) Signal Type: Y, Pb, Pr		
		2) Available Format: 480i, 480p, 576i, 576p, 720p, 1080i		
		3) Frequency: Refer to page 63.		
S-Video	Signal Format: NTSC, PAL, SECAM			
Composite				
RS-232C	Service Port			
User Environment	Temperature and Humidity	Operating	Temperature (32~104°F / 0~40°C), Humidity (10~80%)	
		Storage	Temperature (-4~-113°F / -20~45°C), Humidity (5~95%)	
	Device Classification	Class B		
	Noise	Min 28dB (Theater Mode)		

The DMD Panel used in DLP Projectors consists of several hundred thousand micro mirrors. As with other visual display elements, the DMD Panel may include a few bad pixels. Samsung and the DMD Panel manufacturer have a rigid, bad pixel identification and limitation procedure in place and products will not exceed the maximum number of bad pixels set by our standards. Rarely, non-displayable pixels may exist, however it does not affect the overall picture quality nor the lifespan of the product.

Remote Control Specifications

Function and Transmission Codes

Button	System Code	Data Code	Button	System Code	Data Code	
(Power) ON	07	99	CUSTOM	07	1E	
(Power) OFF	07	98	STILL	07	42	
COMP.1 (Component1)	07	86	V.KEYSTONE	07	81	
COMP.2 (Component2)	07	88	INSTALL	Front-Floor	07	BB
COMPOSITE	07	84		Front-Ceiling	07	EE
S-VIDEO	07	85		Rear-Floor	07	EF
PC	07	69		Rear-Ceiling	07	BF
DVI	07	8A	MENU	07	1A	
P.SIZE	Full	07	QUICK	07	58	
	Zoom1	07	INFO	07	1F	
	Zoom2	07	EXIT	07	2D	
	4 : 3	07	▲ (Up)	07	60	
P.MODE	Dynamic	07	▼ (Down)	07	61	
	Standard	07	◀ (Left)	07	65	
	Movie1	07	▶ (Right)	07	62	
	Movie2	07	↵ (Enter)	07	68	
	User1	07				
	User2	07				
	User3	07				
	Custom	07				

Remote Control Signal Format

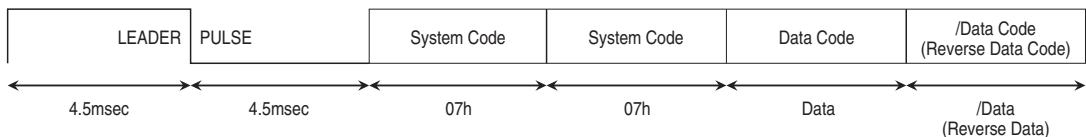

| Memo

| Memo

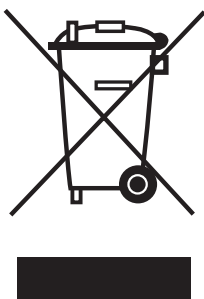

Europe Only

**Correct Disposal of This Product
(Waste Electrical & Electronic Equipment)**

(Applicable in the European Union and other European countries with separate collection systems)

This marking shown on the product or its literature, indicates that it should not be disposed with other household wastes at the end of its working life. To prevent possible harm to the environment or human health from uncontrolled waste disposal, please separate this from other types of wastes and recycle it responsibly to promote the sustainable reuse of material resources.

Household users should contact either the retailer where they purchased this product, or their local government office, for details of where and how they can take this item for environmentally safe recycling.

Business users should contact their supplier and check the terms and conditions of the purchase contract. This product should not be mixed with other commercial wastes for disposal.