

HITACHI

Inspire the Next

HDD
hard disk

DVD
VIDEO
RAM

S
TM

RAM
COMPATIBLE

DZ-HS403/DZ-HS401(W)/(P)

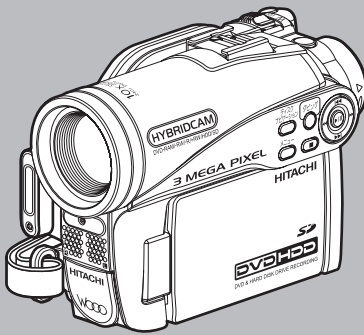

DZ-HS403

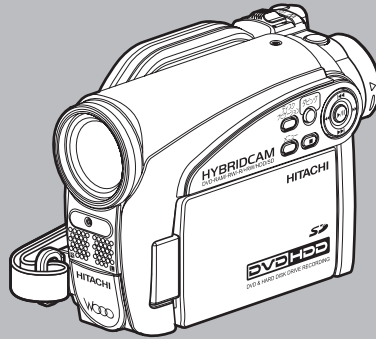

DZ-HS401

Instruction manual

To obtain the best performance and ensure years of trouble-free use, please read this entire instruction manual.

Important Information

For Your Safety

The power switch turns the DVD video camera/recorder on and off, leaving the date/time feature unaffected. If the camera/recorder is to be left unattended for a long period of time, turn it off.

WARNING: TO PREVENT FIRE OR SHOCK HAZARD, DO NOT EXPOSE THIS UNIT TO RAIN OR MOISTURE.

WARNING: TO PREVENT FIRE OR SHOCK HAZARD, USE THE RECOMMENDED ACCESSORIES ONLY.



WARNING: TO PREVENT FIRE OR SHOCK HAZARD, BE SURE TO USE THE SPECIFIED AC ADAPTER/CHARGER (DZ-ACS3).

The DVD video camera/recorder and AC adapter/charger have the following caution marks.



CAUTION

**RISK OF ELECTRIC SHOCK
DO NOT OPEN**



CAUTION: TO REDUCE THE RISK OF ELECTRIC SHOCK, DO NOT OPEN. NO USER-SERVICEABLE PARTS INSIDE. REFER SERVICING TO QUALIFIED SERVICE PERSONNEL.

Identifications of caution marks



This symbol warns the user that uninsulated voltage within the unit may have sufficient magnitude to cause electric shock. Therefore, it is dangerous to make any kind of contact with any inside part of this unit.



This symbol alerts the user that important literature concerning the operation and maintenance of this unit has been included. Therefore, it should be read carefully to avoid any problems.

Precautions

WARNING: Many television programs and films are copyrighted. In certain circumstances, copyright law may apply to private in-home videotaping of copyrighted materials.

This Class B digital apparatus complies with Canadian ICES-003.

The liquid crystal display (LCD) panel is made by highly precise technology. More than 99.99% of its picture elements (pixels) are effective, but some (less than 0.01%) may appear as colored bright dots. This does not indicate a fault as the LCD panel stretches the limits of current technology.

**CLASS 1
LASER PRODUCT**

CAUTION

This product contains a laser diode of higher class than 1. To ensure continued safety, do not remove any covers or attempt to gain access to the inside of the product. Refer all servicing to qualified personnel.

Microsoft®, Windows®, Windows® Me, Windows® 2000 Professional, and Windows® XP are registered trademarks of Microsoft Corporation.

Windows Vista™ is a trademark of Microsoft Corporation.

Intel®, Pentium® Processor, and Celeron® Processor are registered trademarks of Intel Corporation.

Intel® Core is a trademark of Intel Corporation.

Macintosh is a trademark of Apple, Inc.

IBM® and PC/AT® are registered trademarks of International Business Machines Corporation.

Manufactured under license from Dolby Laboratories.

“Dolby” and the double-D symbol are trademarks of Dolby Laboratories.

Other company names and product names listed are trademarks or brand names belonging to each individual company.

SD logo is a trademark.

IMPORTANT SAFETY INSTRUCTIONS

In addition to the careful attention devoted to quality standards in the manufacture of your video product, safety is a major factor in the design of every instrument. But, safety is your responsibility too.

This page lists important information that will help to assure your enjoyment and proper use of DVD video camera/recorder and accessory equipment.

- 1** Read these instructions.
- 2** Keep these instructions.
- 3** Heed all warnings.
- 4** Follow all instructions.
- 5** Do not use this apparatus near water.
- 6** Clean only with dry cloth.
- 7** Do not block any ventilation openings. Install in accordance with the manufacturer's instructions.
- 8** Do not install near any heat sources such as radiators, heat registers, stoves, or other apparatus (including amplifiers) that produce heat.
- 9** Protect the power cord from being walked on or pinched particularly at plugs, convenience receptacles, and the point where they exit from the apparatus.
- 10** Only use attachments/accessories specified by the manufacturer.
- 11** Use only with the cart, stand, tripod, bracket, or table specified by the manufacturer, or sold with the apparatus. When a cart is used, use caution when moving the cart/apparatus combination to avoid injury from tip-over.

- 12** Unplug this apparatus during lightning storms or when unused for long periods of time.
- 13** Refer all servicing to qualified service personnel. Servicing is required when the apparatus has been damaged in any way, such as power-supply cord or plug is damaged, liquid has been spilled or objects have fallen into the apparatus, the apparatus has been exposed to rain or moisture, does not operate normally, or has been dropped.
- 14** The apparatus shall not be exposed to dripping or splashing and that no objects filled with liquids, such as vases, shall be placed on the apparatus.
- 15** The equipment (AC Adapter/Charger) shall be used near the socket-outlet and shall be easily accessible.

Cautions on HDD

Save the data recorded on HDD:

- To back up the data recorded on HDD, save it on a DVD. It is also recommended that you use this DVD video camera/recorder to dub the data. You can also use a PC to save the data on a DVD.
- It is recommended that you periodically save your recordings.

Do not subject the DVD video camera/recorder to any vibrations or impact:

- This could result in the HDD not being recognized or recording, playback or dubbing to become impossible.
- Do not subject this DVD video camera/recorder to any vibrations or impact especially during recording, playback or dubbing, or while the ACCESS/PC indicator is lit or blinking.
- If vibrations to this DVD video camera/recorder are repeated, or the drop status of DVD video camera/recorder is detected (see page 69), recording, playback or dubbing will stop to protect the HDD in this DVD video camera/recorder.

Carefully check the temperature of this DVD video camera/recorder:

- If the temperature of this DVD video camera/recorder is too high or too low, normal recording or playback may not be possible.
- If the power switch is set to "HDD" with the temperature of this DVD video camera/recorder too high or too low, message "The temperature of HDD is outside the operating temperature range. Turn off power." may appear to protect the HDD. Even if this happens, setting the power switch to "DVD" may allow you to use the DVD video camera/recorder with a DVD, so it is recommended that you carry a spare DVD even if you intend to record on the HDD.

This DVD video camera/recorder cannot be used at high altitude:

- Note that the DVD video camera/recorder cannot be used in a place where the atmospheric pressure is low, such as 3,000 meters or more above sea-level.

Do not place this DVD video camera/recorder near a magnet or magnetic field:

- If you do, recording, playback or dubbing may not be possible.

Please note in advance that Hitachi will not accept any liability or make compensation for loss of data, or direct or indirect damage when recording or playback is not performed normally due to a fault in this DVD video camera/recorder. This also applies to repairs on this DVD video camera/recorder (including repair of components other than HDD).

Cautions When Using

- Hitachi cannot compensate for any damages caused when recording is not made normally or recorded contents cannot be played back because of a defect in the DVD video camera/recorder, disc or card. Also, Hitachi cannot be responsible for your recorded video and audio.
- If you or a third party make a mistake when handling this DVD video camera/recorder, disc, card, etc., the recorded contents may be lost. We cannot be responsible for compensation for damage due to loss of recorded contents.

Handle the liquid crystal display (LCD) with care:

- The LCD is a very delicate display device: Do not press its surface with force, hit it or prick it with a sharp object.
- If you push the LCD surface, unevenness in display may occur. If unevenness does not disappear soon, turn the DVD video camera/recorder off, wait for a few moments, and then turn it on again.
- Do not place the DVD video camera/recorder with the open LCD screen down.
- Close the LCD monitor when not using the DVD video camera/recorder.

Liquid crystal display (LCD) and viewfinder:

- The LCD screen and viewfinder are the products of highly precise technology. Among the total number of pixels (approx. 120,000 pixels for LCD monitor and equivalent to approx. 200,000 pixels for viewfinder), 0.01% or less pixels may be missing (black dots) or may remain lit as colored dots (red, blue, green). This shows the limitations of the current technology, and does not indicate a fault that will interfere with recording.
- The LCD screen and viewfinder will be slightly dimmer than usual when the DVD video camera/recorder is at low temperature, as in cold areas, or immediately after power is turned on. Normal brightness will be restored when the temperature inside the DVD video camera/recorder rises.

Hold the DVD video camera/recorder correctly:

- Do not hold the viewfinder or LCD monitor when lifting the DVD video camera/recorder: The viewfinder or LCD monitor could detach and the DVD video camera/recorder may fall.

Do not subject the DVD video camera/recorder to impact:

- This DVD video camera/recorder is a precision machine. Take great care that you do not strike it against a hard object or let it fall.
- When using a tripod, firmly secure the DVD video camera/recorder on it. Do not use the DVD video camera/recorder with a tripod in a place where it is subject to severe vibrations or impact.

No sand or dust!

- Fine sand or dust entering the DVD video camera/recorder or AC adapter/charger could cause malfunctions or defects.

No water or oil!

- Water or oil entering the DVD video camera/recorder or AC adapter/charger could cause electric shock, malfunctions or defects.

Heat on surface of product:

- The surfaces of the DVD video camera/recorder, AC adapter/charger and battery will be slightly warm, but this does not indicate a fault.

Screen on connected TV:

- Never leave the Disc Navigation screen, still image or camera image displayed on your TV to which the DVD video camera/recorder is connected: Doing so could result in displayed image retention or phosphor degradation of TV screen.

Be careful of ambient temperature:

- If the temperature of this DVD video camera/recorder is too high or too low, normal recording/playback may not be possible.
- Take care that the temperature of this DVD video camera/recorder, when connected to PC does not rise excessively (reference for usage: approx. 30 minutes at about 86°F (30°C)).
- Do not leave the DVD video camera/recorder on beach sand or in a closed vehicle where the temperature is very high for a long time: This could cause malfunctions.

Do not point directly at the sun:

- If direct sunlight strikes the lens or viewfinder, the DVD video camera/recorder could malfunction or a fire could occur.
- Do not leave the DVD video camera/recorder with the LCD screen exposed to direct sunlight: This could cause malfunctions.

Do not use the DVD video camera/recorder near TV or radio:

- This could cause noise to appear on the TV screen or in radio broadcasts.

Do not use the DVD video camera/recorder near strong radio waves or magnetism:

- If the DVD video camera/recorder is used near strong radio waves or magnetism, such as a radio wave tower or electric appliances, recording or playback may stop, or noise could enter the video and audio that are being recorded. During playback of normally recorded video and audio, noise may also be present in picture and sound.
At worst the DVD video camera/recorder could malfunction.

Do not expose the DVD video camera/recorder to soot or steam:

- Thick soot or steam could damage the DVD video camera/recorder case or cause malfunctions.

Do not use the DVD video camera/recorder near corrosive gas:

- If the DVD video camera/recorder is used in a place where there is dense exhaust gas generated by gasoline or diesel engine, corrosive gas such as hydrogen sulfide, or sulfur such as in a hot spring area, the external or internal terminals could corrode, which would disable normal operation, or the battery connecting terminals could corrode, so power will not turn on.

Do not use the DVD video camera/recorder near ultrasonic humidifier:

- With some water in humidifier, calcium and other chemicals dissolved in water could scatter in the air, and white particles could adhere to the optical head of the DVD video camera/recorder, which could cause it to operate abnormally.

Do not expose the DVD video camera/recorder to insecticide:

- Insecticide entering the DVD video camera/recorder could dirty the lens in laser pickup block for DVD, and in such a case the DVD video camera/recorder might not operate normally. Turn the DVD video camera/recorder off and cover it with vinyl sheet, etc. before using insecticide.

Do not use a generally available 8 cm CD lens cleaner:

- Cleaning the DVD lens is not necessary when using this DVD video camera/recorder in the usual way.
- Using 8 cm CD lens cleaner could cause this DVD video camera/recorder to be faulty.
- If you have to clean the lens, use a Hitachi Maxell cleaner that is exclusively for 8 cm DVD discs.

Be careful of moisture condensation:

- When you move the DVD video camera/recorder between places where the difference in temperatures is great – such as entering a lodge from a ski slope or going out of a cooled room or vehicle – condensation (vapor in air warmed or cooled to water droplets) could occur on the lens and/or inside the DVD video camera/recorder. If condensation occurs, do not open the cover of disc or card insertion block if possible. If condensation occurs on the lens, wipe it off with a soft, dry cloth. Even if the external surface of DVD video camera/recorder has dried, condensation may remain inside: Turn the DVD video camera/recorder off and leave it in a dry place for at least 1 – 2 hours before using it again.

Do not use the DVD video camera/recorder for a long uninterrupted period of time:

- This DVD video camera/recorder cannot be used for a long time continuously as a surveillance camera/monitor. If you use it for a long continuous period of time, the temperature of DVD video camera/recorder could exceed the limit and the recording/playback operation may slow down or other faults could occur. If this happens, turn it off and wait for a while before using it again.

Do not turn the DVD video camera/recorder off while the ACCESS/PC indicator or CARD ACCESS indicator is lit or blinking:

- The ACCESS/PC or CARD ACCESS indicator is lit or blinking to show that data is being written to disc or card, or being read from it. At this time, do not do any of the following, so as not to damage the data:
 - Remove battery
 - Disconnect AC adapter / charger
 - Plug or unplug PC connection cable
 - Remove disc or card
 - Subject DVD video camera/recorder to severe vibrations or impact
 - Violently open or close the LCD monitor

ACCESS/PC
indicator

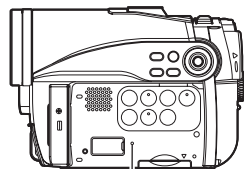
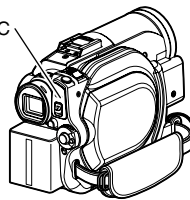

CARD ACCESS indicator

The ACCESS/PC indicator will light for a while after recording is finished. While it is lit, do not subject the DVD video camera/recorder to any vibration or impact, and do not disconnect the battery or AC adapter / charger. If, when using HDD/DVD, you turn the DVD video camera/recorder off while the ACCESS/PC indicator is lit or blinking, turn it on again: When using a DVD, turn it on with the DVD loaded. The HDD/DVD will be restored (see page 142).

Do not wipe the DVD video camera/recorder case with benzene or thinner:

- The coating of case could peel off or the case surface could deteriorate.
- When using a chemical cleaning cloth, follow the instructions.

Also read the instructions attached with optional accessories:

- For optional accessories, observe the cautions and follow instruction manuals attached.

The battery provided has not been charged at time of purchase:

- Charge it before using the DVD video camera/recorder (see page 29).
- The battery will discharge as time passes. (The battery is produced so that it discharges on its own in order to protect its characteristics.)

Disc cannot be inserted or removed unless a charged battery or AC adapter/charger is connected to the DVD video camera/recorder.

Be sure to set the power switch to “OFF” when turning the DVD video camera/recorder off:

- Disconnecting the battery or AC adapter / charger while the DVD video camera/recorder is being powered could cause a fault.

Cautions When Storing

Do not leave the DVD video camera/recorder in a place where the temperature is very high for a long period of time:

- The temperature inside a closed vehicle or trunk can become very high in a hot season. If you leave the DVD video camera/recorder in such a place, it could malfunction or the case could be damaged. Also, do not expose the DVD video camera/recorder to direct sunlight or place it near a heater.

Do not store the DVD video camera/recorder in a place where the humidity is high or in a dusty place:

- Dust entering the DVD video camera/recorder could cause malfunctions. If the humidity is high, the lens could be moldy, and the DVD video camera/recorder could become inoperable. It is recommended that you put the DVD video camera/recorder with desiccant in a box when storing it in a closet, etc.

Do not store the DVD video camera/recorder in a place subject to strong magnetism or intense vibrations:

- This could cause malfunctions.

Detach the battery from the DVD video camera/recorder and store it in a cool place:

- Leaving the battery attached or storing it at high temperature could shorten its life.

Suggestions and Restrictions

Make a trial recording:

- Always make a trial recording before doing actual recording to make sure that recording is normal. The data that have not been stored normally because of a defect in the DVD video camera/recorder cannot be restored.

It is recommended that you use the HDD from which recorded contents can be deleted for trial recording.

Do not use the DVD video camera/recorder for professional applications:

- This DVD video camera/recorder is designed and produced for home-use recording and playback.

Copyright:

- Data recorded on the HDD/disc/card in this DVD video camera/recorder using other digital/analog media or devices are protected by the copyright act and cannot be used without permission of the owner of copyright, except for personal enjoyment. Be aware that recording is restricted for some demonstrations, performances and exhibitions, even for personal enjoyment.

CLEANING

Be sure to set the power switch to "OFF" before cleaning this DVD video camera/recorder.

●Cleaning LCD screen and camera lens

Use dry, soft cloth to wipe dirt off. When cleaning the LCD screen, be careful not to use force, scratch it, or subject it to impact: Doing such could cause a defect in the screen, result in display unevenness, or damage the LCD monitor.

●If dust adheres to the viewfinder lens, remove it using a cotton swab, etc.

Do not rub the lens with force: Doing so could scratch the lens.

●Cleaning DVD Video Camera/Recorder Case

Do not wipe the DVD video camera/recorder case hard with any foreign object, such as grit, adhering to it, and do not use rough fabrics to clean the case: Doing so could scratch it.

Use soft cloth, etc. to gently wipe dirt off the case.

●Do not use benzene or thinner to clean DVD video camera/recorder case

The coating of case could peel off or the case could deteriorate. Wipe off dirt on the case with a soft cloth which has been completely wrung out. When using chemical cleaning cloth, follow instructions for use.

HANDLING DISCS

●Using discs

Discs are very delicate recording media. Carefully read the following cautions and observe them:

- Always use a brand new disc when recording important material.
- Be sure not to touch the recording surface of disc, or dirty or scratch it.
- **If there is dust, scratch, dirt on disc or if it is warped**, the following phenomena may occur:
 - Block noise in playback image
 - Momentary stop of playback image
 - Sound interrupted during playback, or abnormal sound
 - Blue thumbnail display* (Fig. 1)
 - Disc cannot correctly be recognized
 - Disc cannot be initialized
 - Delay between video and audio



Block noise

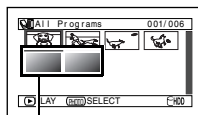
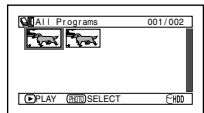

Fig. 1

Even if disc is normal, the above phenomena may occasionally occur. While the ACCESS/PC indicator is lit, do not subject disc to vibrations or impact, and avoid using DVD video camera/recorder at extremely high or low temperatures, or in environment where condensation is likely to occur.

- When recording images, the DVD video camera/recorder may avoid the portions of disc where recording is not possible, due to dust, scratches, etc. [It will pause **●II** at such a portion and automatically restart recording (**●REC**).]



(Recording one scene may produce multiple thumbnails.)

- This will cause recording to be interrupted for several seconds to several minutes, and multiple thumbnails will be created by one recording session as shown above. In this case, the recordable time on disc will decrease.
- Be careful when removing the disc since the metal of removal slot of DVD video camera/recorder, and disc itself, may be hot.

●Storing discs

- When storing disc, replace it in the plastic case in which it was purchased.
- Be careful that no condensation occurs on disc.
- Do not place disc in following places:
 - **Direct sunlight for a long time**
 - **Where humidity is high or in dusty place**
 - **Where there is heat from a heater, etc.**

DISC CLEANING

Use the disc cleaning cloth provided to lightly wipe off any dirt adhering to the disc as shown in the figure. Do not wipe the disc with force: Doing so could cause scratches.

Never use solvent (thinner, water, antistat or detergent) for cleaning.

Lightly wash the dirty cleaning cloth with detergent: The dirt removal capacity of the cloth will improve (rinse the cloth well with water so that no detergent remains).



Use the disc cleaning cloth to clean from inner to outer edges in axial direction.

NOTE WHEN TRANSFERRING OR DISCARDING DISCS AND SD MEMORY CARDS

- The “Format” function on this DVD video camera/recorder will only change the file control information: It will not completely delete the data in the built-in hard disk; your personal data could leak out. To prevent the data from leaking out, execute complete deletion of HDD (see p. 111).
- “Formatting” or “deletion” using the functions of DVD video camera/recorder or PC will change only the file control information: It will not completely delete the data on disc or memory card.
- When transferring or discarding a disc or memory card, it is recommended that you physically destroy it or use deletion exclusive software (generally available) to completely delete the data on it. It is user’s responsibility to control the data on disc and memory card.
- Hitachi will not accept any responsibility for leaking of personal data.

Read This First

To guide you, we have included following five chapters.

- The section on “Setups” explains how to set up the DVD video camera/recorder, battery, and set the date/time.
 - The section on “Basic Techniques” explains the basic operation of this DVD video camera/recorder – recording of movies, still images, external input and playback of recorded images.
 - The section on “Disc Navigation” explains editing with Disc Navigation: Refer to this section when dubbing from HDD to disc, finalizing a DVD-RW/DVD-R/+RW and initializing a DVD-RAM/DVD-RW/+RW.
 - The section on “Connecting to PC” explains the contents of provided CD-ROM and how to install the software included.
 - “Subsidiary Information” includes an introduction to products sold separately, and troubleshooting.
- A quick index for the information you use most often.
 - A detailed table of contents directing you to specific information quickly (see pages 14 – 16).

Get to know your DVD video camera/recorder by using this manual, and get to know Hitachi. We appreciate your business.

Quick Index

Available Discs	26
Recording Movie	43
Playing Back.....	73
Functions Available with Disc Navigation	80
Dubbing on DVD.....	84
Connecting to a TV.....	116
Connecting to PC	122

We want this manual to be as helpful as possible, so it includes two easy ways to find the information you need:

With this DVD video camera/recorder you can view the picture being recorded or the playback picture whether on the LCD monitor or in the viewfinder. Opening or closing the LCD monitor switches the picture to appear on the LCD monitor or in the viewfinder.

It is possible to switch the language in the on-screen display of this DVD video camera/recorder (see page 35).

About This Manual

● Displays in this manual

Understand that the displays are different from those you will actually see in the viewfinder or on the LCD screen.

● Notation of cancel button

Press the stop/cancel button to stop your operation midway, or return the menu screen to the preceding one. The expression “press the ■ button” will be used in this text.

● **HDD**, **RAM**, **RW VR**, **RW VF**, **R**, **+RW** and **CARD** marks beside headings

Some functions of this DVD video camera/recorder are unavailable with HDD/disc/card used. Refer to the marks at right above each function to identify whether the HDD/disc/card is compatible with the function. Refer to these marks and identify the functions and operation to match the HDD/disc card you use.

● Information on DZ-HS401(W) and DZ-HS401(P)

Body color is the only difference between DZ-HS401(W) and DZ-HS401(P): Operation of the two models is identical. This manual refers to these models simply as DZ-HS401.

Introduction

- **Recording is possible on both HDD and DVD: In FINE mode, recording for up to 3 hours is possible on HDD; up to 30 minutes on DVD (p. 43, 159).**
- **Dubbing to an 8 cm DVD can be performed on this DVD video camera/recorder using only one button: Simple dubbing without a DVD recorder or PC (p. 84).**
- **You can capture photos from videos (p. 75).**

You can record an image displayed during playback of video as a photo on a card.

- **You can start recording immediately after stopping playback (p. 43, 74).**

Unlike tape devices, you do not need to search for the recording start position or locate the beginning of blank portion.

You can stop playback and immediately start recording: New recording will not overwrite any previously recorded data.

- **You can immediately play back desired recorded scenes (p. 73).**

You do not need to rewind, unlike recorders using tape.

You can select any scene you want and immediately play it back (using Disc Navigation function).

- **Use Disc Navigation to create your original movie (p. 102).**

You can delete unnecessary scenes, move any scenes, etc., and create your original movie work (Play List). To edit the scenes recorded on the HDD, use the dubbing function to easily create a DVD from the edited original movie. If you edit the scenes recorded on a disc, you can play back the edited original movie and easily dub it on another DVD recorder or VCR.

- **Create original DVDs on PC (p. 122).**

You can create an original DVD, using the provided software CD-ROM.

The created DVD disc can be played back on DVD player/recorder, DVD-ROM drive, etc.

Setting Up Camera Functions	60	DUBBING ALL SCENES RECORDED ON HDD (DUBBING "ALL")	87
SELECTING SHOOTING MODE TO MATCH THE SUBJECT (SWITCHING PROGRAM AE MODE).....	60	SELECTING SCENES RECORDED ON HDD AND DUBBING THEM (SCENE "SELECT" DUBBING)	88
RECORDING DARK SUBJECTS USING LCD MONITOR LIGHT	61	TURNING OFF DUBBED MARK FROM THUMBNAIL (MARK OFF)	88
ADJUSTING COLOR (WHITE BALANCE).....	61	Scene	89
USING THE ELECTRONIC IMAGE STABILIZER (EIS).....	63	DELETING SCENES (EDIT - DELETE)	89
RECORDING SUBJECT USING LARGE MAGNIFICATION (DIGITAL ZOOM)	63	DIVIDING MOVIES (EDIT - DIVIDE)	90
REDUCING WIND NOISE DURING RECORDING (MIC.FILTER)	63	COMBINING MULTIPLE SCENES (EDIT - COMBINE).....	91
Setting Up Record Functions	64	ARRANGING ORDER OF SCENES (EDIT - MOVE).....	91
SWITCHING MOVIE QUALITY (VIDEO MODE)	64	DIRECTING SCENES EFFECTIVELY (EFFECT - FADE).....	92
SETTING TO WIDE TV SCREEN MODE (16:9 MODE).....	65	PLAYING BACK BY SKIPPING SCENES (EFFECT - SKIP)	93
SWITCHING QUALITY OF STILL IMAGE (QUALITY)	67	CHANGING IMAGES FOR THUMBNAILS (EFFECT - THUMBNAIL).....	94
RECEIVING IMAGE FROM ANOTHER DEVICE (INPUT SOURCE)	67	COPYING STILLS ON DVD-RAM TO CARD (COPY)	95
SWITCHING EXTERNAL INPUT RECORDING METHOD (PHOTO INPUT)	68	LOCKING SCENES ON CARD (LOCK)	96
SELF-TIMER	68	SELECTING SCENES USING MENU SCREEN (SELECT).....	97
SETTING ON-SCREEN DISPLAY OUTPUT ON OR OFF (OSD OUTPUT)	69	DISPLAYING INFORMATION USING MENU SCREEN (DETAIL).....	98
DROP DETECTION (HDD PROTECTION).....	69	Program	99
Using External Microphone	70	WHAT IS "PROGRAM"?	99
		SWITCHING TO THUMBNAIL DISPLAY OF SPECIFIC DATE (SELECT)	99
		PLAYING BACK PROGRAM (PLAY)	100
		CHANGING TITLE OF PROGRAM (TITLE).....	100
		Play List.....	102
		WHAT IS "PLAY LIST"?	102
		CREATING NEW PLAY LIST (CREATE)	102
		SWITCHING TO DISPLAY OF EACH PLAY LIST (SELECT).....	103
		PLAYING BACK A PLAY LIST (PLAY).....	103
		ADDING SCENES TO PLAY LIST (EDITING PLAY LIST)	104
		DELETING SCENES FROM PLAY LIST (EDITING PLAY LIST)	105
		ADDING SCENES USING SUBMENU FOR EDITING (EDITING PLAY LIST).....	105
		DELETING SCENES USING SUBMENU FOR EDITING (EDITING PLAY LIST).....	106
		SELECTING SCENES USING SUBMENU FOR EDITING (EDITING PLAY LIST).....	106
		ARRANGING ORDER OF SCENES (MOVE)	107
		CHANGING TITLE OF PLAY LIST (TITLE).....	108
		DELETING PLAY LIST (DELETE).....	108
		Go To	109
		MOVING TO BEGINNING (END) OF HDD/DVD/ CARD	109
		HDD/DVD/Card Management	109
		INITIALIZING HDD/DVD/CARD	109
		PROTECTION	110
		VERIFYING REMAINING FREE SPACE ON DISC OR CARD (CAPACITY).....	110
Disc Navigation			
Using Disc Navigation	71		
STARTING OR TERMINATING DISC NAVIGATION.....	71		
PLAYING BACK FROM DISC NAVIGATION SCREEN.....	73		
ADJUSTING VOLUME DURING PLAYBACK	73		
PLAYING BACK LATEST RECORDED SCENE	74		
DELETING LAST RECORDED SCENE.....	74		
CAPTURING PHOTO.....	75		
SEARCH PLAYBACK OF MOVIE	75		
FRAME ADVANCE/FRAME BACK/SLOW PLAYBACK OF MOVIE	75		
SKIP PLAYBACK OF MOVIE	76		
PLAYING BACK STILLS	76		
JUMPING TO SPECIFIED POINT (GO TO).....	77		
INFORMATION DISPLAY DURING PLAYBACK.....	78		
SELECTING MULTIPLE SCENES	79		
SELECTING CONSECUTIVE SCENES TOGETHER.....	79		
FUNCTIONS AVAILABLE WITH DISC NAVIGATION.....	80		
UNDERSTANDING FLOW OF DISC NAVIGATION MENU	81		
Dubbing on DVD	84		
FIRST-TIME ("NEW") DUBBING	85		
DUBBING SCENES RECORDED ON SAME DAY COLLECTIVELY ("DATE" DUBBING)	86		







UPDATING CONTROL INFORMATION OF HDD/DVD-RAM/DVD-RW (VR-MODE) (UPDATE CONTROL INFO.).....	111	Cautions when connecting DVD video camera/ recorder to PC	140
DELETING DATA ON HDD (FULL FORMAT)	111		
FINALIZING DVD-RW/DVD-R/+RW (FINALIZE DVD)	112		
ADDITIONALLY RECORDING ON FINALIZED DVD-RW (VF-MODE)/+RW (UNFINALIZE DVD).....	113		
Others	114		
DISPLAYING DUBBED/UNDUBBED SCENES IN LIST (CATEGORY).....	114		
DISPLAYING MOVIES OR STILLS INDEPENDENTLY (CATEGORY)	114		
PLAYING BACK SCENES REPEATEDLY (REPEAT PLAY).....	115		
PLAYING BACK WIDE-MODE IMAGES ON 4:3 DISPLAY TV (TV TYPE).....	115		
SLIDE SHOW (CONTINUOUS PLAYBACK OF STILLS).....	115		
Viewing on TV Screen	116		
CONNECTING TO A TV	116		
VIEWING ON TV SCREEN	117		
Playback on DVD Recorder/Player.....	118		
PLAYING BACK DVD-RAM/DVD-RW (VR-MODE)	118		
PLAYING BACK DVD-RW (VF-MODE)/DVD-R/ +RW.....	118		
Recording (Dubbing) Images.....	119		
RECORDING (DUBBING) IMAGES FROM OTHER VIDEO DEVICE.....	119		
RECORDING (DUBBING) IMAGES ON OTHER VIDEO DEVICES.....	121		
Connecting to PC			
Software Provided	122		
Requirements of available PC	123		
Installing Software	124		
Connecting to PC via			
PC Connection Cable.....	127		
USING DISC IN DVD DRIVE BUILT INTO PC	129		
BEFORE TERMINATING PC CONNECTION (UNPLUGGING PC CONNECTION CABLE)/ CHANGING OVER POWER SWITCH	130		
Using ImageMixer 3 for Windows	131		
VIEWING IMAGES RECORDED ON HDD/DISC USING PC	131		
CREATING DVD-VIDEO USING IMAGES RECORDED ON HDD/DISC	132		
Using ImageMixer 3 Mac Edition for DVDCAM.....	135		
VIEWING IMAGES RECORDED ON HDD/DISC USING MACINTOSH.....	135		
IMPORTING IMAGES RECORDED ON HDD/ DISC INTO MACINTOSH	136		
CREATING DVD-VIDEO USING IMAGES RECORDED ON HDD/DISC	137		
Uninstalling Software	139		

Subsidiary Information

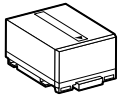
Introduction to Optional Accessories	141
CAMERA ACCESSORIES	141
POWER SUPPLY	141
Trouble Messages	142
Troubleshooting	149
System Reset	156
Major Specifications.....	157
STORAGE CAPACITY OF HDD/DVD/CARD....	159
RECORDABLE STILLS (PHOTOS) ON CARD	160
Index	161
Be sure to read the following before opening the package of CD-ROM	163

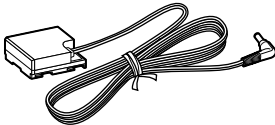
Checking Provided Accessories

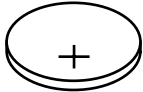
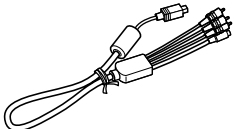
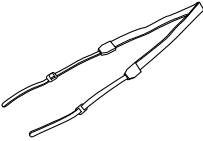
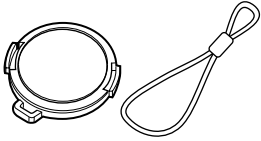
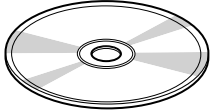
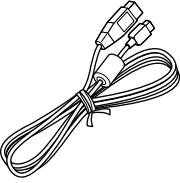
Make sure that you have all the following accessories in package:

<p>Battery (model DZ-BP14S): Portable power supply for this DVD video camera/recorder. Charge it before use.</p> 	<p>AC adapter/charger (model DZ-ACS3): Used to power the DVD video camera/recorder from AC outlet, or charge battery.</p> 	<p>DC power cord: When powering the DVD video camera/recorder from household AC outlet, use this cord to connect the DVD video camera/recorder and AC adapter/charger.</p> 
<p>Power cable: Connect between household AC outlet and AC adapter/charger.</p> 	<p>Infrared remote control (model DZ-RM4J): Use to control the DVD video camera/recorder from a distance.</p> 	<p>Lithium battery (model CR2032): To power the remote control.</p> 
<p>AV/S input/output cable: Used when viewing the picture played back on the DVD video camera/recorder on TV screen, or input or output video from/to another video device.</p> 	<p>Shoulder strap: Attach to the DVD video camera/recorder to hang it from shoulder.</p> 	<p>Lens cap and lens cap string: Attach the lens cap when not recording, to protect the lens.</p> 
<p>Software CD-ROM: Use this CD-ROM when connecting the DVD video camera/recorder to PC.</p> 	<p>PC connection cable: Use this cable when connecting the DVD video camera/recorder to PC.</p> 	<p>Disc cleaning cloth: Always use this to clean discs.</p> 

Names of Parts

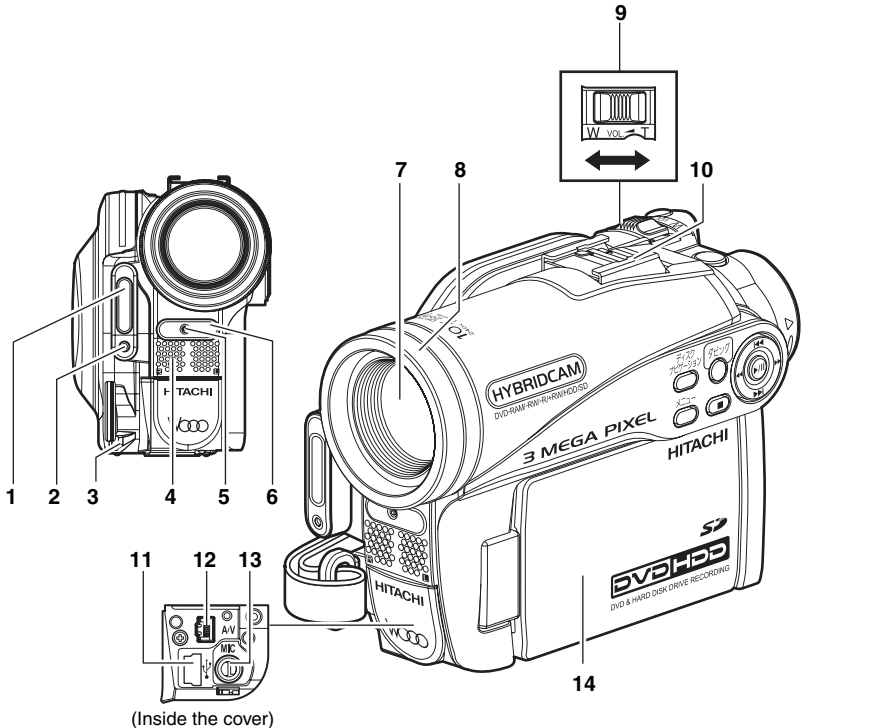

1 Flash (for DZ-HS403 only) (p. 58)

2 Light receiving sensor (for DZ-HS403 only)

This sensor controls the amount of light to be emitted from the built-in flash. Take care not to block with hand, etc. during recording.

3 Lens cap string attachment hole (p. 23)

4 Stereo microphone

Take care that the microphone is not blocked by a hand, etc., during recording.

5 Recording indicator (p. 37, 43, 68)

The red indicator will light during recording.

6 Infrared receiver (p. 24)

When the remote control is used to operate the DVD video camera/recorder, this receiver will receive the infrared signal.

7 Optical 10× zoom lens (for DZ-HS403 only)

Optical 15× zoom lens (for DZ-HS401 only)

(p. 53)

8 Lens hood (for DZ-HS403 only) (p. 54)

Always remove this lens hood when using the optional tele-conversion or wide-conversion lens.

9 Zoom lever (p. 53, 55, 73)

To adjust the zoom or volume.

10 Accessory shoe (for DZ-HS403 only)

The optional microphone can be attached here. (See the instruction manual of device to be attached for details.)

11 PC connection terminal (TO PC) (p. 127)

12 AV input/output jack (p. 116, 119)

13 External microphone jack (p. 70)

14 Wide-screen color liquid crystal display (inside) (p. 34)

Although the external appearances of DZ-HS403 and DZ-HS401 are different, the method of operating these models is identical. DZ-HS403 illustrations are used in this manual.

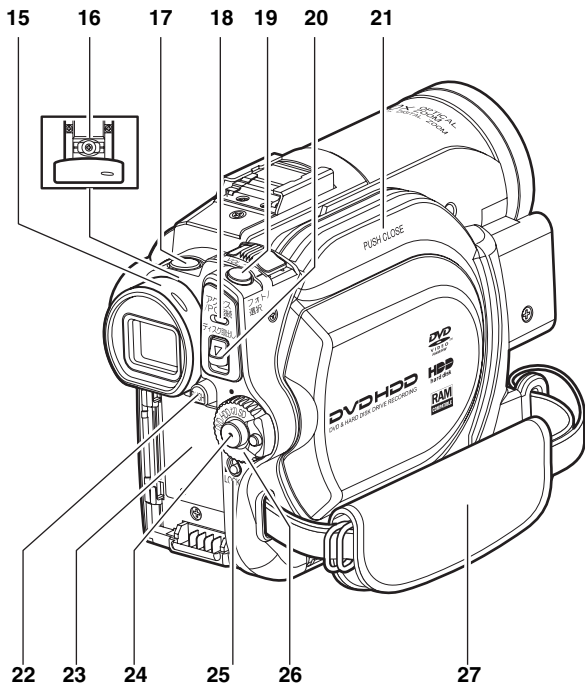

15 Viewfinder (p. 34)

16 Diopter control (p. 34)

To adjust the focus of image appearing in the viewfinder. (Pull out the viewfinder.)

17 秒撮 (SLEEP/RESTART) button (p. 45)

To switch the sleep/restart status between ON and OFF.

18 アクセス/PC接続 (ACCESS/PC) indicator (p. 8, 43)

Will blink or light when the HDD/DVD is accessed (write or read), or the DVD video camera/recorder is connected to a PC.

19 フォト/選択 (PHOTO/SELECT) button (p. 44, 79, 97)

20 ディスク取出し (DISC EJECT) button (p. 40)

Press down and release this button to open the cover of DVD insertion block.

21 DVD insertion block (p. 40)

22 BATTERY EJECT button (p. 30)

Press this button when removing the battery.

23 Battery attachment platform (p. 30)

24 Record button (REC) (p. 43)

25 LOCK switch (p. 43)

It is recommended that you set the LOCK switch to  (to the upper position) to prevent the power switch in the "HDD" position from accidentally moving to "DVD".

26 Power switch (p. 33)

27 Hand strap (p. 22)

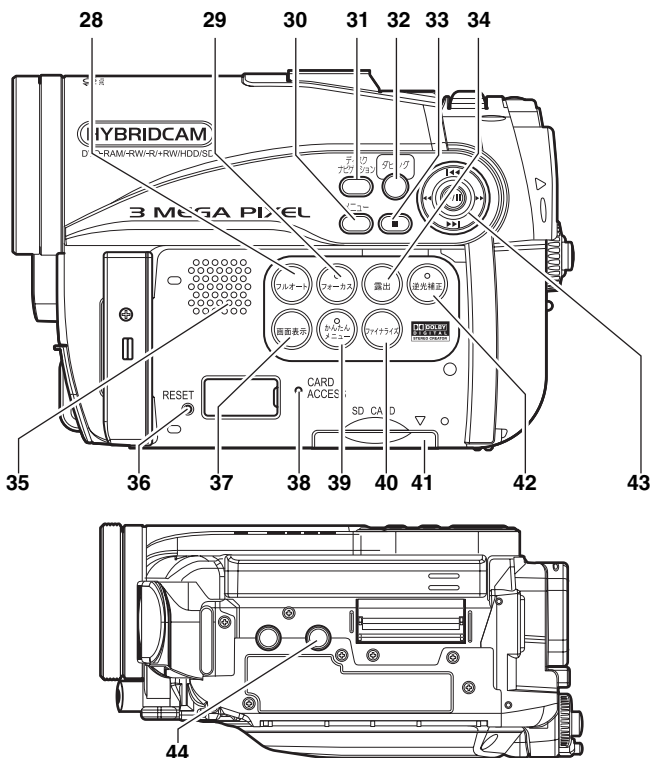

- 28 フルオート (FULL AUTO) button (p. 59)**
To switch the DVD video camera /recorder to full automatic.
- 29 フォーカス (FOCUS) button (p. 55)**
To switch between manual focus and auto-focus.
- 30 メニュー (MENU) button (p. 35, 51, 90)**
Press this button to display the menu for setting camera functions and Disc Navigation.
- 31 ディスクナビゲーション (DISC NAVIGATION) button (p. 71)**
- 32 ダビング (DUBBING) button (p. 85)**
- 33 Stop/cancel button (p. 12, 51, 74)**
To end playback or cancel setting of menu.
- 34 露出 (EXPOSURE) button (p. 57)**
Press this button to adjust the exposure.
- 35 SPEAKER (p. 73)**
- 36 RESET button (p. 156)**
To reset all settings to defaults (status when the DVD video camera/recorder was shipped from the factory).
- 37 画面表示 (DISPLAY (Screen display)) button (p. 46, 78)**
Press this button to display the details of image being played back or camera setting status, or switch the display off.

- 38 CARD ACCESS indicator (p. 8, 44)**
- 39 かんたんメニュー (QUICK MENU) button (p. 51)**
To display only the functions that you frequently use (simple menus).
- 40 ファイナライズ (FINALIZE) button (p. 112)**
Press this button to finalize the recorded DVD-RW /DVD-R/+RW.
- 41 Card insertion block (p. 42)**
- 42 逆光補正 (BLC (backlight compensation)) button (p. 57)**
Press this button when subject is being lighted from rear.
- 43 ◀◀ / ▶▶ / ◀▶ / ▶▶ / ▶ / || buttons (p. 35, 51, 55, 57, 74, 75, 76)**
Use these buttons to select a scene or menu item, and then press the center (▶/||) to play back the scene, or designate an option from the menu. These buttons are also used to adjust the exposure or focus.
- 44 Tripod threaded hole**
Used to attach the DVD video camera/recorder to a tripod.

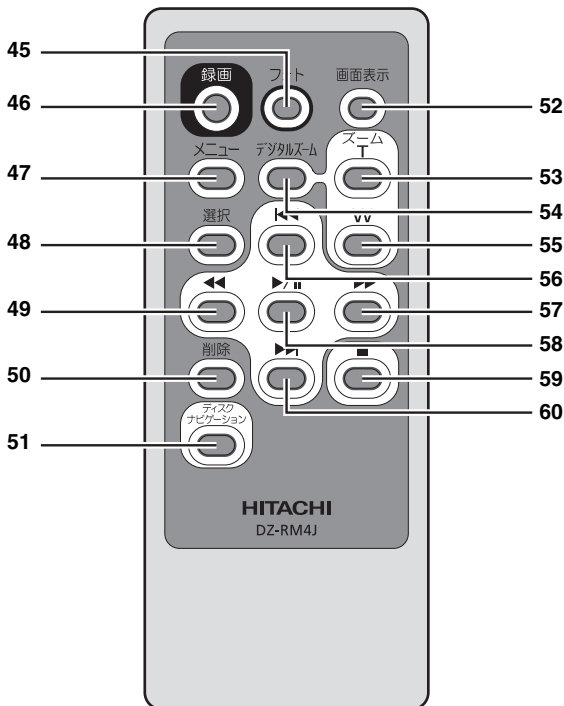

45 フォト (PHOTO) button (p. 44)

46 録画 (REC) button (p. 43)

47 メニュー (MENU) button (p. 35, 51, 90)

48 選択 (SELECT) button (p. 79, 97)

49 Reverse search button (p. 75)

50 削除 (DELETE) button (p. 89)

51 ディスクナビゲーション
(DISC NAVIGATION) button (p. 71)

52 画面表示 (DISPLAY) button (p. 46, 78)

53 ズームT (ZOOM T) button (p. 53)

54 デジタルズーム (DIGITAL ZOOM) button
(p. 53)

55 ズームW (ZOOM W) button (p. 53)

56 Reverse skip button (p. 76)

57 Forward search button (p. 75)

58 Play/pause button (p. 74)

59 Stop button (p. 12, 51, 74)

60 Forward skip button (p. 76)

* The buttons on remote control will function the same as those on DVD video camera/recorder.

Setups

This section explains preparations for recording – setting up the DVD video camera/recorder and battery.

Demonstration Function

This DVD video camera/recorder is equipped with a demonstration function.

The default at purchase time is “Auto”, which will automatically start the demonstration approx. ten minutes after the DVD video camera/recorder, connected to the AC adapter/charger, is turned on and left unoperated.

Refer to “CHANGING SETTING OF DEMONSTRATION” on page 37 if you wish to view the demonstration immediately or change the setting to “Off”.

DVDHDD

HITACHI
Inspire the Next

Setting Up the DVD Video Camera/Recorder

HOLDING DVD VIDEO CAMERA/RECORDER

Insert your right hand from the bottom of DVD video camera/recorder up to the base of your thumb. Put your hand in a position where you can easily operate the REC button and the Zoom lever. Adjust the length of hand strap so that the DVD video camera/recorder is stable when you press the REC button with your thumb.

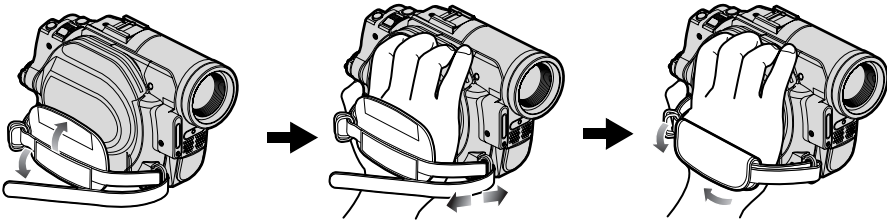

ATTACHING SHOULDER STRAP

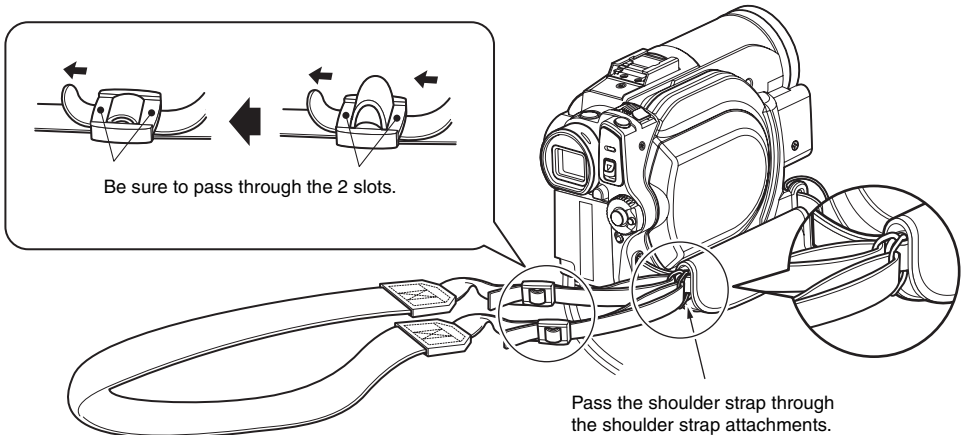

ATTACHING LENS CAP

- 1 Attach the shorter end of lens cap string to the lens cap.
- 2 Attach the longer end of lens cap string to the attachment hole of DVD video camera/recorder.
- 3 Push the both sides of cap inward and attach it over the lens.

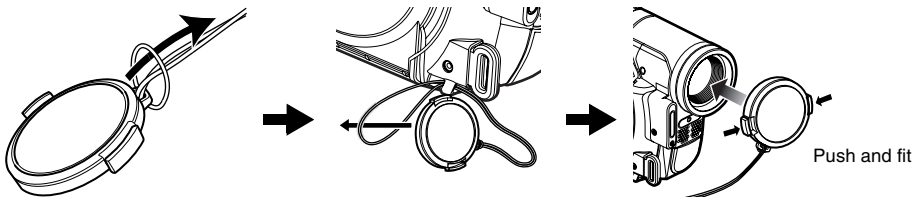
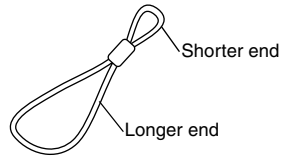

Note:

- Always keep the lens cap on when not using the DVD video camera/recorder, to protect the lens.
- When recording, attach the lens cap to the hand strap by hooking the tab inside the cap onto strap for comfortable shooting.

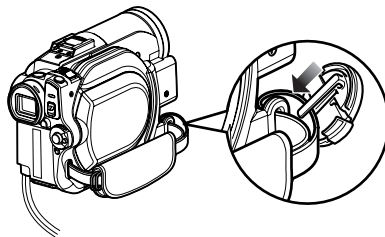

INSERTING BATTERY INTO REMOTE CONTROL

Insert the provided lithium battery into remote control.

- 1 While inserting a fine rod into the hole marked PUSH, pull the battery holder out forward.
- 2 Insert the lithium battery with the positive \oplus terminal facing down.
- 3 Slide the cover to close it.

Note:

- The life of lithium battery is approximately one year. If the battery is discharged, no operation is possible with remote control: Replace the battery.

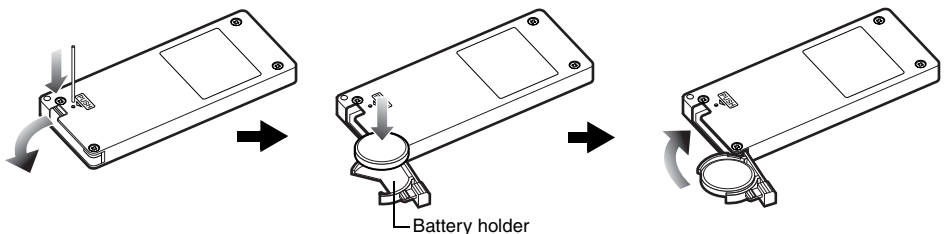

REMOVING BATTERY FROM REMOTE CONTROL

- 1 While pushing the battery holder, slide the battery out.

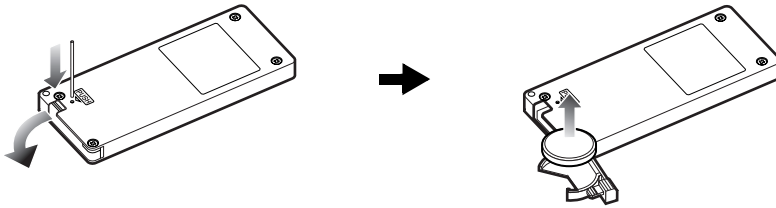

Warning:

- KEEP THE BATTERY AWAY FROM CHILDREN AND PETS.
- IF SWALLOWED, CONSULT A PHYSICIAN IMMEDIATELY FOR EMERGENCY TREATMENT.
- BATTERY MAY EXPLODE IF NOT HANDLED PROPERLY. DO NOT RECHARGE, DISASSEMBLE OR DISPOSE OF IN FIRE.

Note:

- Replace the battery with a Hitachi Maxell, Sony, Panasonic, Sanyo, Toshiba CR2032, or Duracell DL2032. Use of another battery may present a risk of fire or explosion.
- Dispose of battery safely in accordance with local laws. Do not dispose of in fire.
- Do not short circuit the battery.
- Do not hold the battery with the metallic tweezers.
- Keep the battery in a dark, cool, dry place.

● Using Remote Control

Point the remote control to the infrared receiver on the DVD video camera/recorder. The remote controllable distance is up to 5 m.

Note:

- When using the remote control, make sure that the infrared receiver on DVD video camera/recorder is not exposed to direct sunlight or any intense light. If the infrared receiver is subject to light stronger than the infrared light from remote control, the DVD video camera/recorder cannot be operated by remote control.
- If there is an obstacle between the remote control and infrared receiver on DVD video camera/recorder, remote control may not be possible.
- The DVD video camera/recorder uses the "VCR2" remote control code of Hitachi VCRs. If you use a Hitachi VCR, etc. with remote control code set to "VCR2", a VCR placed near the DVD video camera/recorder will also be operated by the remote control: To prevent this, change the remote control code of the VCR.

HDD/DVD/Cards

The following table lists the storage media (discs and cards) that can be used on this DVD video camera/recorder and the functions which are available with them:

Function	Media						
	HDD	DVD-RAM	DVD-RW (VR mode)	DVD-RW (VF mode)	DVD-R	+RW	SD memory card
To record video (p. 43)	●	●	●	●	●	●	—
To record photo (p. 44)	—	—	—	—	—	—	●
To delete image just recorded (p. 74)	●	●	●	—	—	●	●
To select image and delete it (p. 89)	●	●	●	—	—	—	●
To edit image (p. 90 – 91)	●	●	●	—	—	—	—
To play on other DVD players and DVD recorders (p. 112)	—	∴*1	∴*1*2	●*2	●*2	∴*1*2	—*3
To use new disc or new card without formatting	—	●*4	—	—	●	—	●*4
To initialize and reuse (p. 109)	●	●	●	●	—	●	●
To additionally record on finalized disc (p. 113)	—	—	●	●*5	—	●*5	—
To edit copied video on PC (p. 122)	●*6	●*6	●*6*7	●*6*7	●*6*7	●*6*7	—
To playback video on PC (p. 122)	●*6	●*6	●*6*7	●*6*7	●*6*7	●*6*7	—

●: Functions available; —: Not available

*1: Playable on devices that conform to either 8 cm DVD-RAM, 8 cm DVD-RW (VR mode) or 8cm +RW.

*2: Must be finalized. Cannot be played on some DVD players or DVD recorders.

*3: Some DVD devices conform to SD memory card.





*4: When media that are sold "formatted" are used. If the initialization format differs, the media can be initialized on this DVD video camera/recorder and then used.

*5: To additionally record, the finalized disc must be unfinalized.

*6: The provided software is used.

*7: Finalize the disc when editing/playing back on PC.

HDD, DISCS

HDD, and usable discs and marks (logos)		Function
HDD		Allows extensive recording (approx. 3 hours in FINE mode). Allows you to delete unnecessary scenes or edit scenes.
DVD-RAM Ver. 2.1 (8 cm)		Allows you to delete unnecessary scenes or edit scenes.
DVD-RW [Ver1.1 (8 cm) 2x speed (2x/1x)]		Allows you to choose the VR mode for deleting unnecessary scenes or editing scenes, or the VF mode in which deletion or editing is not possible, but high compatibility with DVD players is provided *1.
DVD-R [for General Ver. 2.0 (8 cm)]		Provides high compatibility with DVD players *1. No deletion or editing is possible.
+RW Ver. 1.2 (8 cm)		Provides high compatibility with DVD players but does not need to be finalized *2. Scenes can be deleted immediately after being recorded.

*1: Playback on all DVD players is not guaranteed. The disc must be finalized before being played back on a DVD player.

*2: Playback on all DVD players is not guaranteed.

Note:

• This DVD video camera/recorder can use only the 8-cm bare discs not packed in a square cartridge, square caddy case or round DVD holder. The discs in a square cartridge, square caddy case or round DVD holder can be used if they are removed from the package, but take great care not to dirty or scratch the bare disc.

• **It is recommended that you use Hitachi Maxell HG type single-sided discs, since their compatibility with this DVD video camera/recorder has been confirmed.**

When using an HG type double-sided disc, take great care with handling it. Using a disc other than these discs may not allow the DVD video camera/recorder to deliver optimum performance.

INFORMATION ON DVD-R

For optimum recording on DVD-R, this DVD video camera/recorder writes control data to the disc in order to automatically make adjustments when it is inserted and ejected accompanying recording.

If the disc has no area to be written for adjustment, recording may not be possible. To prevent this, do not insert or eject a DVD-R accompanying recording more than 100 times.

This DVD video camera/recorder cannot record a DVD-R in the VR mode.

NOTES ON FINALIZATION

• **Do not insert a DVD-RW/DVD-R recorded or dubbed on this DVD video camera/recorder but not finalized, into a recordable device, such as a DVD recorder: The recorded data may be damaged.**

• Use only DZ-HS403/HS401 to record/dub or finalize a DVD-RW (VF-mode)/DVD-R/+RW recorded or dubbed on this DVD video camera/recorder but not finalized: Using any other device could damage the data recorded on the disc.

• DVD-RW/DVD-R/+RW edited and finalized on PC or those finalized on another DVD recorder may not be playable on this DVD video camera/recorder, depending on the editing software used or recorded status of DVD-RW/DVD-R/+RW.

• If you insert a DVD-R recorded on a DVD video camera/recorder other than DZ-HS403/HS401 and not finalized, the Disc Navigation screen will automatically start, and no recording can be done on the disc nor can it be finalized.

• Do not insert a DVD-RW/DVD-R that was recorded by a DVD recorder manufactured by a company other than Hitachi, and which has not been finalized, in this DVD video camera/recorder: Doing so will make the disc unusable.

EXAMPLES OF DISCS THAT CANNOT BE USED ON THIS DVD VIDEO CAMERA/RECORDER

- CD
- CD-R
- CD-RW
- CD-ROM
- DVD-ROM
- DVD-Video
- DVD-R (4.7 GB) for Authoring Ver. 2.0
- DVD-R DL (Dual Layer)
- DVD-RW DL (Dual Layer)
- +R DL (Double Layer)
- +RW DL (Double Layer)
- +R
- Discs other than those with diameter of 8 cm

AVAILABLE CARDS

SD memory cards can be used on this DVD video camera/recorder (incompatible with 2 GB).

When using an exclusive adapter, a miniSD memory card and micro SD memory card can be used in the same way as an SD memory card. No SDHC card or multimedia card can be used.

● Handling card

- Do not use cards other than the designated ones.
- Be sure to perform trial recording before recording vital images.
- Do not touch the card terminal or allow it to touch metal.
- Do not paste anything other than exclusive label on label pasting portion.
- Do not subject card to impact, bend or drop it.
- Do not disassemble card or modify it.
- Do not expose card to water.
- Do not use or store card in the following places:
 - Where the temperature is high, such as in vehicle at high temperatures, under burning sun or near a heater
 - Where humidity is high, or in dusty place
- When the erasure prevention switch is locked, no recording, deletion or editing will be possible on the card: Only playback will be possible.

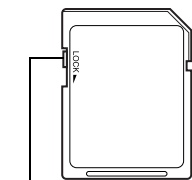
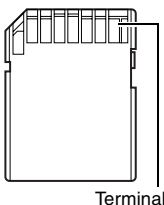

Erasure prevention switch

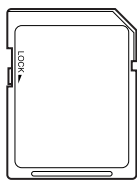

Locked status

CAUTIONS FOR DISC AND CARD

- It is recommended that you create a backup file for valuable data on hard disk of PC.
- Do not do the following, or the data on disc or card may be damaged or lost:
 - Do not remove the disc or card or turn DVD video camera/recorder off during reading or writing of data
 - Do not use DVD video camera/recorder in a place subject to static electricity or electrical noise
 - Do not have printing done at a print lab or DPE service
 - Do not leave a DVD unused in the DVD video camera/recorder for a long time

Note:

- This DVD video camera/recorder can play back image data recorded on other digital cameras conforming to the DCF (Design rule for Camera File system) standard. The range of image data playable on this DVD video camera/recorder is that with pixels from 80 horizontal × 60 vertical to 4000 horizontal × 3000 vertical.
- DCF is an integrated image file format of digital cameras: Image files can be used on all digital devices conforming to DCF.
- Image data edited on PC and certain types of image data may not be visible on this DVD video camera/recorder.
- The image data recorded on another device may not be playable on this DVD video camera/recorder.

Preparations for Power Supply

USING DVD VIDEO CAMERA/RECORDER WITH AC ADAPTER/CHARGER

It is recommended that you use the AC adapter/charger to power the DVD video camera/recorder from household AC outlet when you perform settings on it, play back or edit images, or use it indoors.

Note:

Be sure to use the specified AC adapter/charger (DZ-ACS3) to power the DVD video camera/recorder. Using other AC adapter/chargers could cause electric shock or result in fire.

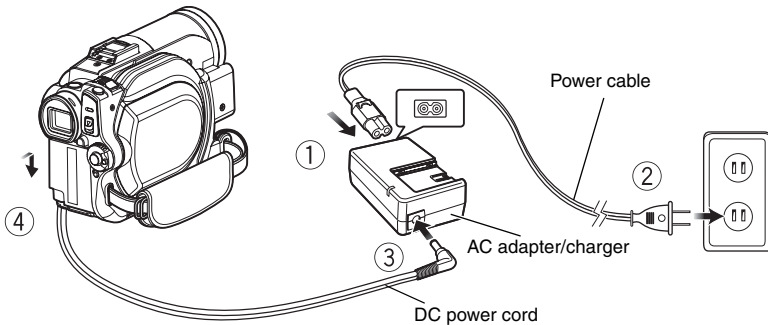

- 1** Connect the power cable to AC adapter/charger.
- 2** Plug the power cable into AC outlet.
- 3** Plug one end of DC power cord into the DC output jack on AC adapter/charger.
- 4** Attach the other end of DC power cord to the battery attachment platform on DVD video camera/recorder.
Use the same procedure as that for battery when attaching and detaching the DC power cord: See page 30.

Setting Up the Battery

The DZ-BP14S battery (provided) has not been charged at purchase time: Charge it before using the DVD video camera/recorder.

Note:

- Be sure to use the DZ-BP14S, DZ-BP14SJ (optional), DZ-BP21SJ (optional) or DZ-BP7SJ (optional, unavailable for DZ-HS403) battery for the DVD video camera/recorder: Using other batteries could cause the DVD video camera/recorder to malfunction, or result in fire.
- Be sure to use the DZ-ACS3 AC adapter/charger to charge the battery: Using other chargers could cause electric shock or fire.
- Charge the battery at temperatures of 10 – 30°C.

CHARGING BATTERY

Use the provided AC adapter/charger to charge the battery.

1 Connect the power cable to AC adapter/charger.

2 Plug the power cable into AC outlet.

3 Attach the battery to AC adapter/charger.

Note:

When charging a battery, unplug the DC power cord from the DC output jack on AC adapter/charger.

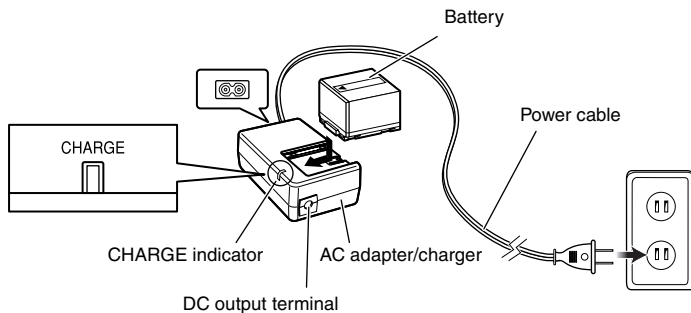

● Battery charged status

You can find out the charged status of battery by checking the CHARGE indicator on AC adapter/charger:

Charge status	CHARGE indicator
During charge	Lit
Charge complete	Goes out

Note:

See "Troubleshooting" on page 149 when the CHARGE indicator blinks.

● Reference for time required to charge battery (at approx. 25°C)

DZ-BP14S (provided)/DZ-BP14SJ (optional): Approx. 165 minutes

DZ-BP21S (optional): Approx. 235 minutes

DZ-BP7SJ (optional, unavailable for DZ-HS403): Approx. 90 minutes

The charge time will vary depending on the remaining power level of battery.

ATTACHING BATTERY TO DVD VIDEO CAMERA/RECORDER

- 1 Fit the battery to the battery attachment platform on this DVD video camera/recorder and slide it downward until a click is heard.

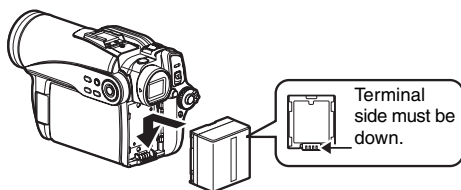

Note:

- Make sure that the battery is in the correct orientation.
- Make sure that the battery is securely attached: Incomplete attachment could cause the battery to fall, resulting in damage.

REMOVING BATTERY

After using the DVD video camera/recorder, remove the battery from it.

- 1 While holding down the BATTERY EJECT button, slide the battery upward to remove it.

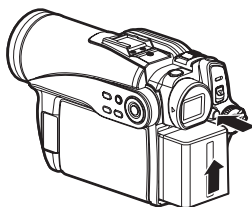

Note:

- For safety, be sure to turn the DVD video camera/recorder off before attaching or removing the battery.
- Be careful not to drop the removed battery.
- If the battery remains attached, minute level current will flow even if the DVD video camera/recorder is off, and the battery will discharge.
- Set the power switch to OFF before removing the battery.

● **Continuously recordable time with fully charged battery (with no zoom operation, etc.)**

See the following table as a reference for how long the DVD video camera/recorder can continuously be used with a fully charged battery:

With DZ-BP14S (provided)/DZ-BP14SJ (optional)

Video mode		DZ-HS403		DZ-HS401	
		HDD	DVD	HDD	DVD
XTRA	When using viewfinder	approx. 125 min	approx. 85 min	approx. 175 min	approx. 145 min
	When using LCD monitor	approx. 115 min	approx. 75 min	approx. 155 min	approx. 130 min
FINE	When using viewfinder	approx. 125 min	approx. 85 min	approx. 175 min	approx. 145 min
	When using LCD monitor	approx. 115 min	approx. 75 min	approx. 155 min	approx. 130 min
STD	When using viewfinder	approx. 125 min	approx. 100 min	approx. 175 min	approx. 170 min
	When using LCD monitor	approx. 115 min	approx. 85 min	approx. 155 min	approx. 145 min

With DZ-BP21S (optional)

Video mode		DZ-HS403		DZ-HS401	
		HDD	DVD	HDD	DVD
XTRA	When using viewfinder	approx. 185 min	approx. 155 min	approx. 260 min	approx. 215 min
	When using LCD monitor	approx. 170 min	approx. 140 min	approx. 230 min	approx. 195 min
FINE	When using viewfinder	approx. 185 min	approx. 155 min	approx. 260 min	approx. 215 min
	When using LCD monitor	approx. 170 min	approx. 140 min	approx. 230 min	approx. 195 min
STD	When using viewfinder	approx. 185 min	approx. 170 min	approx. 260 min	approx. 255 min
	When using LCD monitor	approx. 170 min	approx. 155 min	approx. 230 min	approx. 215 min

With DZ-BP7SJ (optional, unavailable for DZ-HS403)

Video mode		DZ-HS401	
		HDD	DVD
XTRA	When using viewfinder	approx. 85 min	approx. 70 min
	When using LCD monitor	approx. 75 min	approx. 65 min
FINE	When using viewfinder	approx. 85 min	approx. 70 min
	When using LCD monitor	approx. 75 min	approx. 65 min
STD	When using viewfinder	approx. 85 min	approx. 80 min
	When using LCD monitor	approx. 75 min	approx. 70 min

- The time is only for reference: It will vary depending on recording contents.

The reference for how long the DVD video camera/recorder can actually be used will be approx. 1/2 to 1/3 of the above time:

The continuously recordable time of DVD video camera/recorder in the above table shows the time available when the DVD video camera/recorder is in the recording mode without using any other function after recording is started. In actual recording, the battery will discharge 2 – 3 times faster than this reference, since the REC button and zoom are being operated, and playback is performed. Assume that the actually recordable time with a fully charged battery is between 1/2 and 1/3 of the above time, and prepare enough batteries to allow for the time you are planning to record on the DVD video camera/recorder.

The continuously recordable time may be less depending on the conditions when the DVD video camera/recorder is used (if recording and recording pause are repeated at short intervals, etc.).

Note that the battery discharges faster in cold places.

Note:

- During and after charging, and when the DVD video camera/recorder is being used, the battery will be warm, but this does not indicate a fault.

BATTERY REMAINING LEVEL INDICATOR

When the battery is used to power the DVD video camera/recorder, the battery remaining level appears in the viewfinder or on the LCD screen as follows:

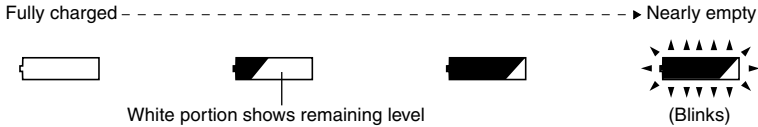

EFFICIENT USE OF BATTERY

- The battery will slightly discharge even if it is detached from the DVD video camera/recorder.
- If the battery is left attached to DVD video camera/recorder, it will consume a slight amount of power. Therefore, it is recommended that you charge the battery shortly before using the DVD video camera/recorder, usually on the day before you plan to use it.

When not using the DVD video camera/recorder for an extended period:

It is recommended that you fully charge the battery once a year, attach it to DVD video camera/recorder and use it up; then remove the battery and store it in a cool place again.

Battery life:

The battery life varies greatly depending on the ambient environment and how often the DVD video camera/recorder is used. If the usable time of DVD video camera/recorder with a fully charged battery is noticeably short, the battery is probably dead: Purchase a new one.

Disposing of a rechargeable battery:

Do not throw away a rechargeable battery. Please take it to the Japan Portable Rechargeable Battery Recycling Center (JBRC), in order to preserve resources.

Refer to the following for collecting and recycling rechargeable batteries, and for shops that perform recycling:

Japan Portable Rechargeable Battery Recycling Center: JBRC (as of January, 2007)

Website: <http://www.jbrc.net/hp/contents/index.html>



Li-ion

Power save and discharge of battery:

It is recommended that you turn the DVD video camera/recorder off in status other than recording, since even during recording pause battery power is consumed at the same level as during recording.

If, when you specify Power Save On, the recording pause status continues for approximately 5 minutes, the DVD video camera/recorder will automatically turn off. To set or release power save, see "TURNING DVD VIDEO CAMERA/RECORDER OFF AUTOMATICALLY (POWER SAVE)" on page 36.

Turning DVD Video Camera/Recorder On and Off

While holding down the gray button at the right of power switch, set the switch according to each recording function:

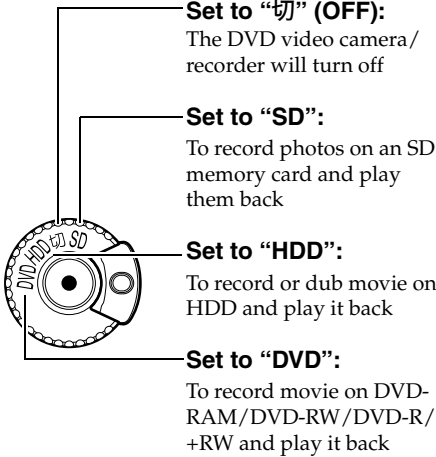

Note:

- Once you turn the DVD video camera/recorder on to let it recognize the disc, you can immediately record or play back by turning the DVD video camera/recorder on again. However, if a long time has elapsed after the disc was inserted, it will take some time for the DVD video camera/recorder to start because it must recognize the disc again (see “Troubleshooting” on page 149).
- It will take some time for the DVD video camera/recorder to display the Disc Navigation screen after power is turned on.
- When the DVD video camera/recorder is turned on, the self-diagnosis function will work and a message may appear. In this case, refer to “Trouble Messages” on page 142 and take corrective action.
- When turning the DVD video camera/recorder off or changing over the power switch between “HDD” and “DVD”, you will not need to hold down the gray button: Simply move the power switch.

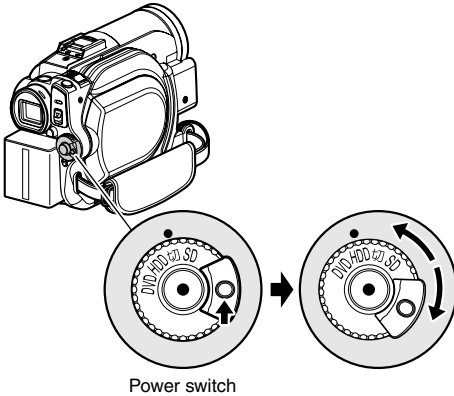

Viewing Images

VIEWING IMAGE ON LCD MONITOR SCREEN

If you open the LCD monitor, you can monitor subject image on the LCD screen.

1 Open the LCD monitor.

The LCD monitor has a portion where you can hook your finger. Hook the finger there to open the monitor.

● Range where the LCD monitor can be moved

The LCD monitor can be opened up to approximately 90°.

If the LCD monitor is open 90°, it can be tilted with the screen down as much as 90°, and can also be tilted with screen up and turned up to 180° so the screen faces in the same direction as the lens.

If the LCD monitor is turned 180° so the screen faces in the same direction as the lens during recording, subject image will also appear in the viewfinder as a mirror image (left/right reversed).

Tilt the LCD monitor to adjust its vertical angle so that you can see the screen easily.

Note:

- If no image appears on LCD monitor screen, refer to “Troubleshooting” on page 149.
- If LCD monitor lights white, refer to page 61.
- Be sure to open the LCD monitor approximately 90° before changing its vertical angle.
- Do not record for a prolonged time with the LCD monitor turned approximately 180° in close contact with the DVD video camera/recorder body: Doing this could cause the DVD video camera/recorder and LCD monitor to become hot.

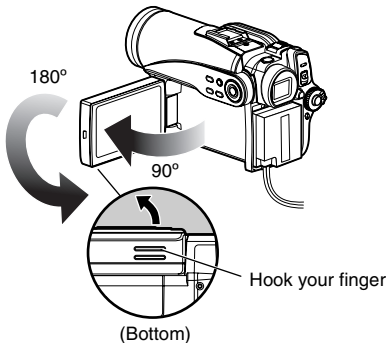

VIEWING SUBJECT THROUGH VIEWFINDER

1 Pull out the viewfinder.

2 Turn the diopter control knob to adjust the focus to suit your eyesight.

Note:

- If no image appears in viewfinder, refer to “Troubleshooting” on page 149.
- If the LCD monitor is opened approximately 90°, the viewfinder will be off: Turn the open LCD monitor 180° so that it faces the same direction as the lens; the image will appear in the viewfinder.
- Focusing will not be correct unless the viewfinder is pulled out.
- See “LCD/EVF Setup” (on page 39) if you wish to display images in the viewfinder regardless of whether you open or close the LCD monitor.

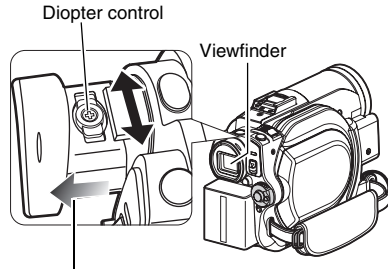

Pull out the viewfinder until a click is heard.

Changing Display Language (Language)

You can change the language used to display the menu and information. The following shows that 日本語(Japanese) is changed to English.

1 Press the MENU button, then select “初期設定” using **◀◀/▶▶/▶▶/▶▶/▶▶/▶▶/▶▶/▶▶**. Then select “言語切替” (Language).

2 Press **▶▶/▶▶** or **▶▶▶▶** button with the screen shown on the right displayed: The “Language” screen will appear.

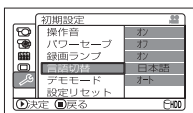

3 Choose “English”, and then press **▶▶/▶▶** button. The display will change to English.



Note:
The language setting will be stored in memory even when the DVD video camera/recorder is turned off.

Setting Date and Time

Set the current date and time so that the date and time you make a recording can be recorded correctly. The following procedure can also be used to correct the date and time you have already set.

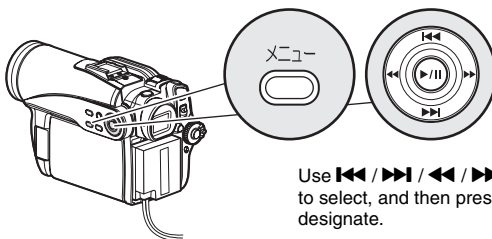

Use **◀◀ / ▶▶ / ▶▶ / ▶▶** buttons to select, and then press **▶▶/▶▶** to designate.

1 Press the MENU button, use the **◀◀/▶▶/▶▶/▶▶** buttons to choose “Date Set” on the “Date Setup” menu screen.

2 Press the **▶▶▶▶** button.

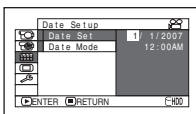

The figure for the month will be selected. [The digit that is highlighted first depends on the date display format (set up in Date Mode): The digit on the left end of the date display will be first highlighted.]

Note:
After setting the figure for the month, press the **▶▶▶▶** button to select the digit to be set. If you press the **▶▶/▶▶** button after selecting the figure for the month, the screen for verifying the set date will appear instead of screen for setting day, year or time.

3 Press the **◀◀** or **▶▶** button to select the digit you want to set in sequence.

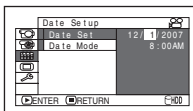

Press the **◀◀** or **▶▶** button to select the number for current date/time, and then repeat step 3 to set the current date and time.

Note:
To stop date/time setting midway, press the **■** button.

- 4 After setting the current date and time, press the ►/|| button.

The screen for verifying the set date will appear.

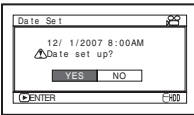

- 5 If the displayed date and time are correct, press the ◀◀ button to choose “YES”, and then press the ►/|| button.

The date and time will be set, and the DVD video camera/recorder will enter the recording pause status. Choosing “NO” will restore the menu screen.

CHANGING DISPLAY FORMAT OF DATE AND TIME

You can select one of three date display formats: month/day/year, day/month/year or year/month/day. Choose “Date Mode” on the “Date Setup” menu screen in procedure 1, and then set to the desired date display mode.

Note:

This DVD video camera/recorder incorporates a rechargeable battery to store the date and time in memory. If this built-in battery is exhausted, the date and time will be reset. To prevent this, every 6 months, connect the AC adapter/charger to DVD video camera/recorder and connect them to AC outlet, or attach a charged battery to the DVD video camera/recorder, and leave it for at least 24 hours with the DVD video camera/recorder turned off: The built-in battery will recharge.



Initial Settings

Press the MENU button, and then use ◀◀▶▶/◀◀▶▶▶/▶/|| buttons to display the “Initial Setup” menu screen. See page 51 for detailed operation procedure. Press the MENU button again to exit setting.

SWITCHING OPERATING SOUND ON OR OFF (BEEP)

Select “On” or “Off”, and then press the ►/|| button.

On: Beep will be heard when the power switch is changed over, the REC button is pressed when HDD/disc is used, the SLEEP/RESTART or EJECT button is pressed, etc.

Off: No beep is heard.

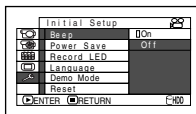

Note:

The “Beep” setting will be stored in memory even when the DVD video camera/recorder is turned off.

TURNING DVD VIDEO CAMERA/RECORDER OFF AUTOMATICALLY (POWER SAVE)

Select “On” or “Off”, and then press the ►/|| button.

On: To engage power save. If the DVD video camera/recorder is left in the recording pause status without being operated for 5 minutes, it will automatically turn off to prevent the battery from discharging needlessly.

Off: To cancel power save.

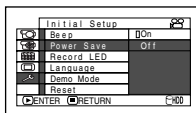

Note:

- To turn the DVD video camera/recorder on again from automatic off activated by the power save function, set the power switch to “OFF”, and then set it to “HDD”, “DVD” or “SD”.
- The Power Save setting will not appear in the on-screen information display.
- If the sleep/restart standby status continues for 30 minutes, the DVD video camera/recorder will automatically turn off regardless of the Power Save setting.

RESETTING MENU SETTINGS TO DEFAULTS (RESET)

You can restore menu settings to defaults (initial settings at the factory (p. 156)). (Note, however, that the date/time will not be reset.)

1 Choose “Reset” on the “Initial Setup” menu screen, and then press the ►/|| button.

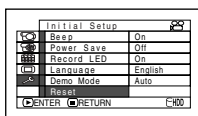

The screen for verifying reset will appear.

2 If you are sure that you wish to reset, use the ◀◀ button to choose “YES”, and then press the ►/|| button.

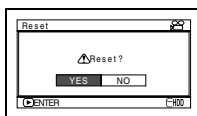

The setting items have now been reset to defaults.

Note:

To cancel resetting midway, choose “NO” on the screen for verification in step 2 or press the ■ button.

TURNING RECORD LED ON OR OFF (RECORD LED)

You can switch off the recording indicator on the front of DVD video camera/recorder even during recording.

Select “On” or “Off”, and then press the ►/|| button.

On: The recording indicator will light red to show that the

DVD video camera/recorder is recording.

Off: The recording indicator will not light even during recording.

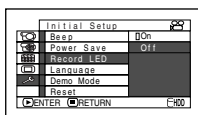

Note:

- The Record LED setting will not appear in the on-screen information display.
- The Record LED setting will be stored in memory even when the DVD video camera/recorder is turned off.
- Specify “Record LED: Off” when recording a subject behind a glass or water tank that reflects light: The reflected light of the recording indicator will not be recorded.
- Even if “Record LED: Off” is specified, the recording indicator will light while the self-timer is counting down.

CHANGING SETTING OF DEMONSTRATION

Choose the desired option using the screen on the right, and then press the ►/|| button.

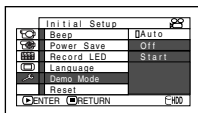

Auto: To start demonstration if the DVD video camera/recorder is connected to AC adapter/charger is inactive for approx. 10 minutes or more after it is turned on.

Off: To set demonstration to off.

Start: To start demonstration immediately.

Note:

- If “Auto” is specified, the demonstration will not start if a battery is connected.
- Pressing the ■ (stop/cancel) or DISC NAVIGATION button will exit demonstration.
- If “Auto” is specified, the demonstration will not start when the power switch on this DVD video camera/recorder is set to “DVD” and a DVD is loaded, or when the power switch is set to “SD” and a card is loaded.
- The demonstration function will not work when the DVD video camera/recorder is connected to PC.
- While the demonstration is being given, the recording indicator will blink.

LCD/EVF Setup

ADJUSTING BRIGHTNESS OF LCD SCREEN (LCD BRIGHTNESS) AND VIEWFINDER (EVF BRIGHTNESS)

1 Press the MENU button, use the **◀◀/▶▶/◀◀/▶▶/▶▶/||** buttons to choose “LCD/EVF Adjust” on the “LCD/EVF Setup” menu screen, and then choose “LCD Brightness” or “EVF Brightness”.

The brightness adjustment bar will appear on the screen.

2 Use the **◀◀/▶▶** buttons for adjustment.

Press **◀◀** :
The screen becomes dimmer.
Press **▶▶** :
The screen becomes brighter.

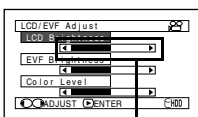

Brightness adjustment bar

3 Press the **▶▶/||** button to end the setting.

Note:

- To stop the setting midway, press the MENU button.
- The brightness setting will be stored in memory even after the DVD video camera/recorder is turned off.

ADJUSTING COLOR DENSITY (COLOR LEVEL)

You can adjust the color density of the LCD monitor screen and viewfinder.

- 1** Press the MENU button, use the **◀◀/▶▶/◀/▶/▶▶/▶▶▶▶** buttons to choose “LCD/EVF Adjust” on the “LCD/EVF Setup” menu screen, and then choose “Color Level”.

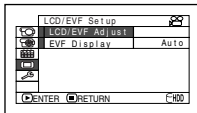

- 3** Press the **▶▶▶▶** button to end the setting.

Note:

- To stop the setting midway, press the MENU button.
- The color setting will be stored in memory even after the DVD video camera/recorder is turned off.
- Even if the brightness or density of LCD monitor screen or viewfinder is changed, the brightness or density of the recorded image itself will not change.

The color density adjustment bar will appear on the screen.

- 2** Use the **◀◀/▶▶** buttons for adjustment.

Press **◀◀** :
For lighter color.
Press **▶▶** :
For denser color.

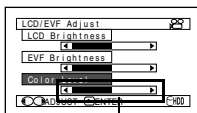

Color density adjustment bar

ALWAYS DISPLAYING IMAGE IN VIEWFINDER

- 1** Press the MENU button, use the **◀◀/▶▶/◀/▶/▶▶/▶▶▶▶** buttons to choose “EVF Display” on the “LCD/EVF Setup” menu screen.

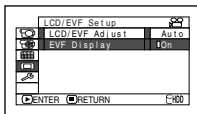

- 2** Choose “On” and press the **▶▶▶▶** button.
- Auto: If the LCD monitor is open, no image will appear in the viewfinder.
- On: Images will always appear in the viewfinder regardless of whether the LCD monitor is open/closed.

Note:

The setting on EVF Display will be stored in memory even after the DVD video camera/recorder is turned off.

Inserting and Removing Disc

1 Set the power switch to “DVD” or “OFF” .

When the power switch is set to “HDD” or “SD”, the cover of disc insertion block will not open. When “Please insert DVD.” appears during dubbing, however, the cover of disc insertion block will open even when the power switch is set to “HDD” (see p. 84).

2 Press down the DISC EJECT button once and release it.

A few moments after the ACCESS/PC indicator blinks, the cover of disc insertion block will open.

3 Gently open the cover by hand fully until it stops.

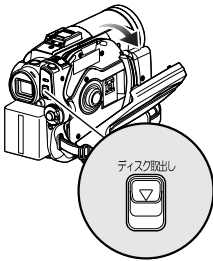

4 When inserting a disc:
Push the disc against the turntable at the center to lock it until a click is heard.

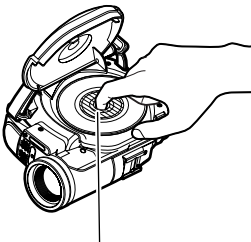

Push the shaded portion.

When removing the disc:

While pushing down the center portion of turntable, pick up the disc, holding its edge, to remove it.

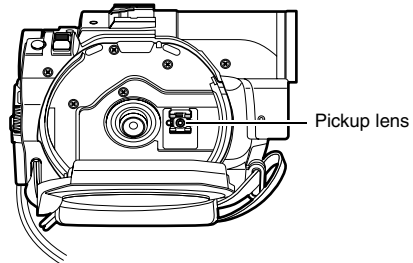
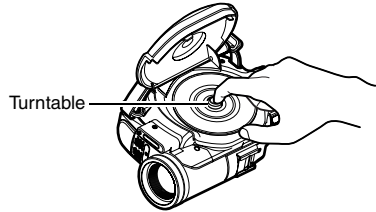

- Note that the recording surface of disc must face the inside of DVD video camera/recorder. When using a single-sided disc, the recording surface is the side without label.
- Never touch the disc recording surface or pickup lens. Touching the pickup lens could cause a fault.
- Use the disc cleaning cloth provided to wipe off any dirt adhering to the disc recording surface.
- Do not use a dirtied or scratched disc.

5 Push the section marked “PUSH CLOSE” on the cover of disc insertion block, to close the cover.

Then the DVD video camera/recorder will automatically recognize the disc: While the ACCESS/PC indicator is lit, do not cut off the power supply, and do not subject the DVD video camera/recorder to any vibrations or impact.

Note:

- If the cover of disc insertion block is open, the ACCESS/PC indicator will blink when an image is displayed on the LCD monitor screen: In this case, the DVD video camera/recorder will not turn off even if the power switch is set to "OFF". If the cover remains open after a while, the DVD video camera/recorder will automatically turn off.
- Disc cannot be inserted or removed unless a charged battery or AC adapter/charger is connected to the DVD video camera/recorder.
- If there is some delay before recording starts, refer to "Troubleshooting" on page 149.
- Do not close the cover if a disc is not properly loaded on the turntable.
- If a single-sided disc is inserted into DVD video camera/recorder with the printed label facing the inside, an error message will appear. Remove the disc and reinsert it with its recording side facing the inside. See "Trouble Messages" on page 142.
- Do not remove the battery or disconnect the AC adapter/charger during removal of the disc or until power is completely turned off: If you do, the disc cover will not open. If this happens, reattach the battery or AC adapter/charger, push down the DISC EJECT button once, and then release it.
- Do not insert anything other than the 8 cm DVD-RAM/DVD-RW/DVD-R/+RW into the disc insertion block: Doing so could cause malfunctions.
- When inserting or removing the disc, BE SURE NOT to look into the lens in laser pickup: Doing so could damage your eyesight.
- Close the cover of disc insertion block gently: Using force could cause a fault.
- **When using double-sided disc**

Recording is possible on both sides of double-sided disc. However, when recording or playback on one side is finished, recording or playback will not move automatically to the other side. Remove the disc once from the DVD video camera/recorder, turn over the disc and insert it again for continued use.

The recording surfaces of double-sided disc are likely to become dirtied or scratched: Always make sure that there is no dirt or scratch on the recording surface facing the pickup lens, and then use the disc taking great care that it is not dirtied or scratched. Use the provided disc cleaning cloth to wipe off any dirt on disc (see page 11).

● When using brand-new DVD-RW/+RW

When a disc is first loaded in the DVD video camera/recorder, the "Format DVD" screen will appear.

When recording on this DVD video camera/recorder:

Choose "Yes" on the "Format DVD" screen, and then press ►/|| button.

When using DVD-RW, choose the recording format (VR or VF mode), and then press the ►/|| button.

The disc will be formatted.

When recording data from PC:

While the "Format DVD" screen is displayed, choose "No" and then press ►/|| button, or press the ■ button.

However, if data from PC has not yet been recorded, the disc can be made usable on this DVD video camera/recorder. When inserting the disc into this DVD video camera/recorder, the same message will appear: If you wish to use it on this DVD video camera/recorder, choose "YES".

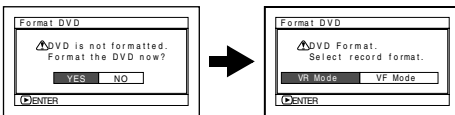

(When using DVD-RW)

Inserting and Removing Card

- 1 Open the LCD monitor.
- 2 Turn the DVD video camera/recorder off.
- 3 Open the cover of card insertion block.
- 4 **Inserting Card:**
Insert card with its terminal inward until it locks.
Removing Card:
Push the center of card edge.
The card will come out so that it can be held by fingers.

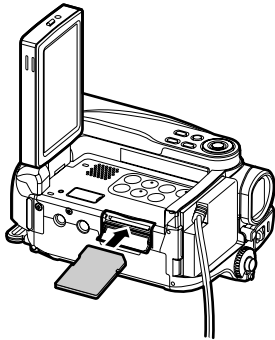

- 5 Close the cover of card insertion block.

Note:

- Always close the cover of card insertion block: Placing the DVD video camera/recorder on a desk, etc. with cover open could damage the cover.

Basic Techniques

This section explains about recording of movies and still images, and also basic settings on DVD video camera/recorder.

HDD RAM RW VR RW VF R +RW

Recording Movie

Before You Begin

- When setting the power switch to “DVD”, insert a recordable DVD-RAM/DVD-RW/DVD-R/+RW into this DVD video camera/recorder.

Pressing REC once will start recording; pressing it once again will temporarily stop recording.

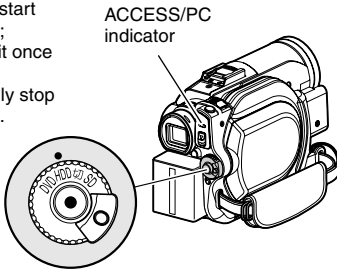

1 Remove the lens cap, and then point the DVD video camera/recorder at subject.

2 Turn the DVD camera/recorder on.

Set the power switch to “HDD” or “DVD” to turn the DVD video camera/recorder on. After the ACCESS/PC indicator goes out, perform the subsequent operation:

3 Check the subject on the screen (viewfinder or LCD).

When using the viewfinder, close the LCD monitor before pulling out the viewfinder.

4 Press the REC button.

The “●II” mark in the viewfinder or on the LCD screen will change to the “●REC” mark, and recording will start.

During recording, the recording indicator on the front of DVD video camera/recorder will light.

Pressing REC again during recording will set the DVD video camera/recorder to the recording pause status.

5 When recording is finished, turn the DVD video camera/recorder off.

Note:

- See “Troubleshooting” on page 149 when recording movie is not possible.
- See “Troubleshooting” on page 149 if it takes some time before recording is possible.
- See “Troubleshooting” on page 149 if the DVD video camera/recorder does not operate.
- See page 46 for on-screen information display.
- It is recommended that you set the LOCK switch to  (the upper position) to prevent the power switch in the “HDD” position from accidentally moving to “DVD” position.
- When using a DVD-RW (VF-mode)/DVD-R, videos of different qualities (VIDEO Modes) or 16:9 On and Off cannot be recorded or dubbed on the same disc (see page 84).
- While the ACCESS/PC indicator is lit or blinking, do not turn the DVD video camera/recorder off, and take care not to subject it to any vibration: Doing so could cause an error in the recorded data, which could make it unplayable (see page 8).
- The minimum recordable time of movie is approximately 3 seconds.
- Hitachi cannot be responsible for video and audio that cannot be recorded or edited because of any defect.
- Each time the DVD video camera/recorder enters the recording pause status, the counter display will be reset to “0:00:00”.
- After recording for 9 hours when using HDD, the DVD video camera/recorder will automatically stop recording: After approx. one minute, it will automatically restart recording (no scene will be recorded during this recording pause). As a result, multiple thumbnails will appear for the scene recorded continuously for more than 9 hours, even with one-time recording of that scene. Mark “●REC” will continue to appear on the screen while the DVD video camera/recorder is automatically pausing when it has continued recording for more than 9 hours.

Recording Stills

Note:

Recording of still images is possible on card.

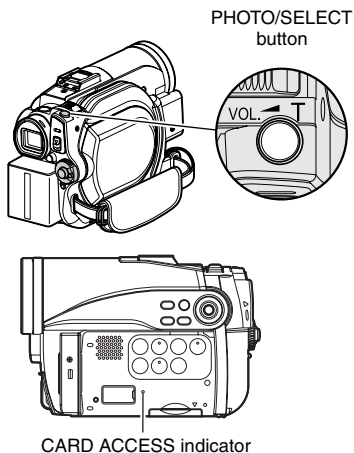

1 Remove the lens cap, and then point the DVD video camera/recorder at subject.

2 Turn the DVD camera/recorder on.

Set the power switch to "SD".

After the CARD ACCESS indicator goes out, perform the subsequent operation:

3 Check the subject on the screen (viewfinder or LCD).

When using the viewfinder, pull it out and close the LCD monitor.

4 Press the PHOTO/SELECT button half way (half pressing).

The DVD video camera/recorder will automatically focus on the subject at the center of screen, and the "●II" indicator on screen will light in purple (the focus will not change when manual focus is chosen).

5 Press the PHOTO/SELECT button all the way (full pressing).

The screen will be black, and then the recorded still will be displayed. When the "●II" mark appears, you can proceed with the next recording; while "CARD ACCESS" is being displayed, you cannot proceed with the next recording.

Note:

- If you wish to record without locating a subject at the center of screen, first locate the subject at the center of screen, press the PHOTO/SELECT button halfway down, determine the composition to be recorded, and then press the PHOTO/SELECT button all the way down.
- If you press the PHOTO/SELECT button all the way down at one stroke without pressing it half way, recording will be possible, but the focus may be incorrect.
- See "Size And Quality Of Photos" on page 160 for details of photos on card.
- See "Troubleshooting" on page 149 if recording photos is not possible.
- If focusing is difficult with auto focus, choose manual focus, and manually correct the focus before recording (see page 55).
- Shake of the DVD video camera/recorder may cause blur in recorded image.
- When holding the DVD video camera/recorder for recording, grasp it securely with both hands.
- When recording with higher zoom magnification, it is recommended that you secure the DVD video camera/recorder on a tripod.
- There may be a difference between the image you see on the LCD screen or viewfinder and the recorded image.

Swift Restart of Recording (SLEEP/RESTART button)

If you press the SLEEP/RESTART button while in the recording pause status instead of turning the DVD video camera/recorder off, the status that recording is possible will be restored in approx. 1 seconds.

Setting to the sleep/restart standby status:

Press the SLEEP/RESTART button in the recording pause status.

The SLEEP/RESTART button will light, and the DVD video camera/recorder will enter the sleep/restart standby status.

In the following cases, pressing the SLEEP/RESTART button will not set the DVD video camera/recorder to the sleep/restart standby status:

- No disc is loaded although the power switch is set to "DVD".
- No card is loaded although the power switch is set to "SD".
- An unusable disc or card is loaded.
- The HDD or a loaded DVD or card has no remaining free space.
- The Disc Navigation screen is being displayed.
- During playback.

Restoring from sleep/restart standby status:

Press the SLEEP/RESTART button that is lit: The DVD video camera/recorder will return to the recording pause status.

Pressing the REC or PHOTO/SELECT button will also restore the DVD video camera/recorder to recording pause from the sleep/restart standby status.

The following operation will release the sleep/restart standby status:

- Press down the DISC EJECT button.
- Change over the power switch ("HDD"↔"DVD").

Note:

- If you press the REC or PHOTO/SELECT button while in the sleep/restart standby status, the sleep/restart status will be released, but recording of a video or photo will not start. To record, press the REC or PHOTO/SELECT button again.
- After the DVD video camera/recorder is restored from the sleep/restart standby status, the zoom position will return to 3x. The settings on manual focus, exposure and rear lighting will also reset to the initial values.
- The DVD video camera/recorder in sleep/restart standby status consumes approx. half the power it does during ordinary recording, but the recordable duration in that status will be longer than standing by in the recording pause status.
- If the sleep/restart standby status continues more than 30 minutes, the DVD video camera/recorder will turn off regardless of the Power Save setting (leaving the DVD video camera/recorder in recording pause status for 5 minutes will also turn it off: Default).
- Setting the power switch to OFF in the sleep/restart standby status will turn the DVD video camera/recorder off.

SLEEP/RESTART button

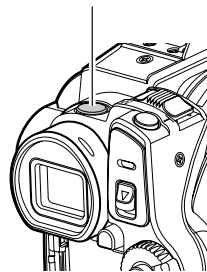

On-Screen Information

Various types of information will appear in the viewfinder or on the LCD screen during recording.

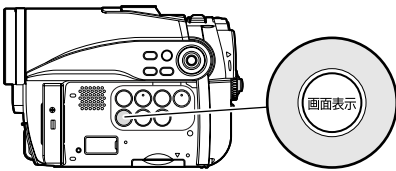



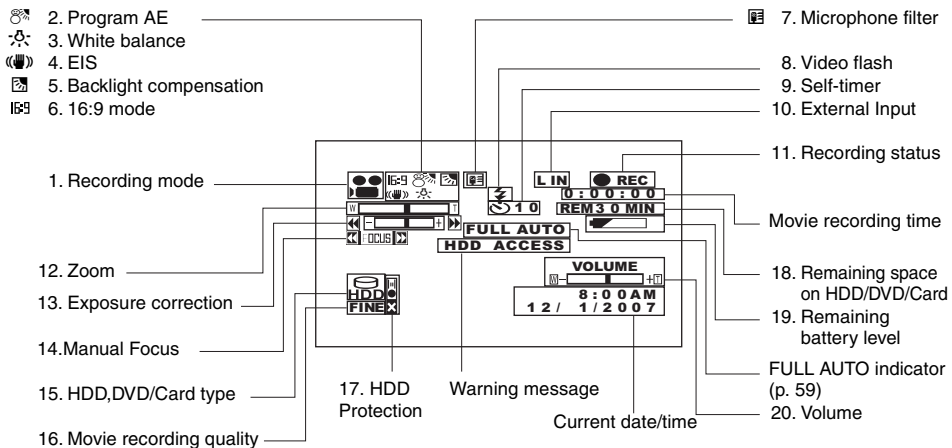

INFORMATION DISPLAY DURING RECORDING

See the next page for details.



The above screen is an example for explanation:
 It is different from the actual display.





1. Recording mode (p. 43, 44, 68)

-  : Movie (HDD/DVD)
-  : Still (Card)
-  : External input still (field) (Card)
-  : External input still (frame) (Card)

2. Program AE (only in movie recording mode) (p. 60)

- No display : Auto
-  : Sports
 -  : Portrait
 -  : Spotlight
 -  : Sand & Snow
 -  : Low Light

3. White balance (p. 61)

- No display : Auto
-  : Set
 -  : Outdoor
 -  : Indoor1
 -  : Indoor2

4. Electronic image stabilizer (EIS) (only in still recording mode) (p. 63)

- No display : EIS OFF
-  : EIS ON

5. Backlight compensation (p. 57)

- No display : Backlight compensation OFF
-  : Backlight compensation ON



6. 16:9 mode (only in movie recording mode) (p. 65)

- No display : 16:9 mode OFF
-  : 16:9 mode ON

7. Microphone filter (only in movie recording mode) (p. 63)

- No display : Microphone filter OFF
-  : Microphone filter ON

8. Video flash*1 (only in still recording mode) (p. 58)

- No display : Emits light automatically
-  : Always emits light
 -  : No light emission



9. Self-timer (only in still recording mode) (p. 68)

- No display : Self-timer OFF
-  : Self-timer ON
(countdown is from 10 seconds)

10. External Input (p. 67)

- L IN : AV input
- S IN : S-VIDEO input

11. Recording status

-  : During recording
-  : During recording pause (lights in green)
When focus locks during photo recording (lights in purple)

No display*2

12. Zoom (p. 53)

W  T
(Digital Zoom: Off)

W  T
(Digital Zoom: 40×*3)

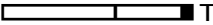
W  T
(Digital Zoom: 240×*4 only in movie recording mode)

















13. Exposure correction (p. 57)

- No display : Auto
-  : Manual

14. Manual focus (p. 55)

- No display : Autofocus
-  : Manual focus

15. HDD, DVD/Card type

-  : HDD
 : HDD (write-protected)
 : DVD-RAM
 : DVD-RAM (write-protected)
 /  : DVD-RW (VR-mode/VF-mode)
 : Protected DVD-RW (VR-mode)
 : DVD-RW (VR-mode) finalized on this video camera/recorder
 : DVD-RW (VR-mode) finalized on a device other than this DVD video camera/recorder
 : Finalized DVD-RW (VF-mode) disc
 : DVD-R
 : DVD-R already finalized on this DVD video camera/recorder
 : DVD-R finalized on a device other than this DVD video camera/recorder (including a DVD-R recorded on a Hitachi DVD video camera/recorder marketed before DZ-HS403/HS401, but not finalized)
 : +RW
 : Finalized +RW
 : SD memory card
 : Locked SD memory card
No display*5

16. Movie recording quality (only in movie recording mode) (p. 64)

- XTRA : Best quality
FINE : High quality
STD : Standard quality

Still recording quality (only in still recording mode) (p. 67)

- FINE : High quality
NORM : Standard quality
ECO : Number of recordable stills is prioritized



17. HDD Protection (p. 69)

- No display : HDD Protection On
 : HDD Protection Off

18. Remaining space on HDD/DVD/Card*6

- REM XX : Remaining recordable minutes
MIN*7 : during movie recording
REM XX*8 : Number of remaining recordable still images during still recording

19. Remaining battery level (p. 32)

-  (full charge)
 ↓
 (low remaining charge)

20. Volume (p. 73)

   :

The volume can be adjusted during external input.

*1 Not displayed on DZ-HS401.

*2 When no disc or card is in the DVD video camera/recorder or disc has not yet been initialized, a write-protected disc or locked card, or a disc or card with no remaining space, has been inserted. Or if the HDD is protected or has no remaining free space.

*3 "60x" on DZ-HS401.

*4 "500x" on DZ-HS401.

*5 No display if no disc or card is loaded, or if a disc or card unusable on this DVD video camera/recorder is loaded.

*6 No remaining time or number will be displayed with a protected disc or locked card, or finalized DVD-RW (VF-mode)/DVD-R/+RW.

*7 In XTRA mode, possible recording time may be longer than the displayed time.

*8 The displayed number of recordable stills is for reference: This number may not decrease, depending on the recording conditions.

●Switching the information display mode

You can switch the display mode of on-screen information:

Press the DISPLAY button.

The full and minimum display modes will alternate.

- **Full display mode:** All types of information will appear.
- **Minimum display mode:** The recording mode (see 1 on page 46) and recording status (see 11 on page 46) will appear. If the DVD video camera/recorder has warning information, a warning message will appear.

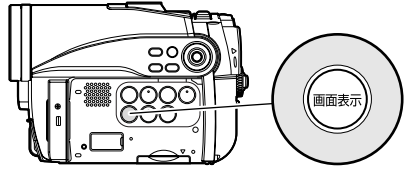

Note:

The DVD video camera/recorder does not record the date and time as a part of image. However, this information during recording will be recorded with image as data which can be checked on Disc Navigation screen during playback (see "INFORMATION DISPLAY DURING RECORDING" on page 46).

●Display when recording an image of yourself

When recording with the LCD screen facing the same direction as the lens, the operating status will appear: The battery remaining level will appear only when the remaining level is very low, and the display will blink.

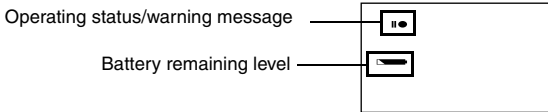
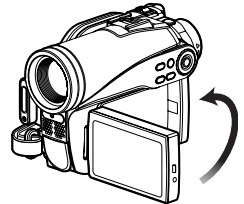







No warning/message (see page 46) will appear when recording with the LCD screen facing the same direction as the lens.

Instead, the following screen display symbols will blink to inform you of the operation status of DVD video camera/recorder.

When the LCD monitor is turned 180° from the position with the LCD screen facing the same direction as the lens, the warning/message can be checked.

● **Interpreting symbols on LCD screen when recording with the screen facing the same direction as the lens**

Screen display symbol	Description
	<ul style="list-style-type: none"> • Status in which recording is not possible on HDD. • An attempt to record a photo on HDD was made.
	<ul style="list-style-type: none"> • An attempt to record a still is being made with a DVD-RAM/DVD-RW/DVD-R/+RW used. • An unusable disc is loaded.
	<ul style="list-style-type: none"> • An attempt to record movie on a card was made. • An unusable card is loaded.
	<ul style="list-style-type: none"> • HDD/disc is write-protected. • A locked card is loaded.
	<ul style="list-style-type: none"> • During recording (lights in red). • The remaining capacity on HDD/disc is approaching the limit 0 (blinks in red).
	<ul style="list-style-type: none"> • During recording pause (lights in green). • During focus lock (lights in purple). • The remaining capacity on HDD/disc/card is approaching the limit 0 (blinks in red). • There is no remaining capacity on HDD/disc/card (blinks in green). • An attempt to record a copy-guarded image is being made (blinks in green).

Note:

- If the LCD screen is set facing the same direction as the lens, the LCD screen will display a mirror image (left and right reversed).
- If the LCD screen is set facing the same direction as the lens, you can also view subject image in the viewfinder.
- Although you can switch to the manual focus, exposure and on-screen display modes even during recording with LCD screen facing the same direction as lens, they will not appear on the screen.
- When the LCD monitor is opened and turned 180° with the Program AE set to Low Light, the monitor screen will light white (see page 61).

Checking Flow of Menu

The following two on-screen menu modes are available with this DVD video camera/recorder:

- Full Menu: To display all menu items for experts
- Quick Menu: To display only the fundamental menu items for first timers

● Operating Menu

The Full Menu will appear if you press the MENU button.

You can use the **◀◀/▶▶/◀◀/▶▶** buttons on DVD video camera/recorder to select various setting options in Full Menu and designate them.

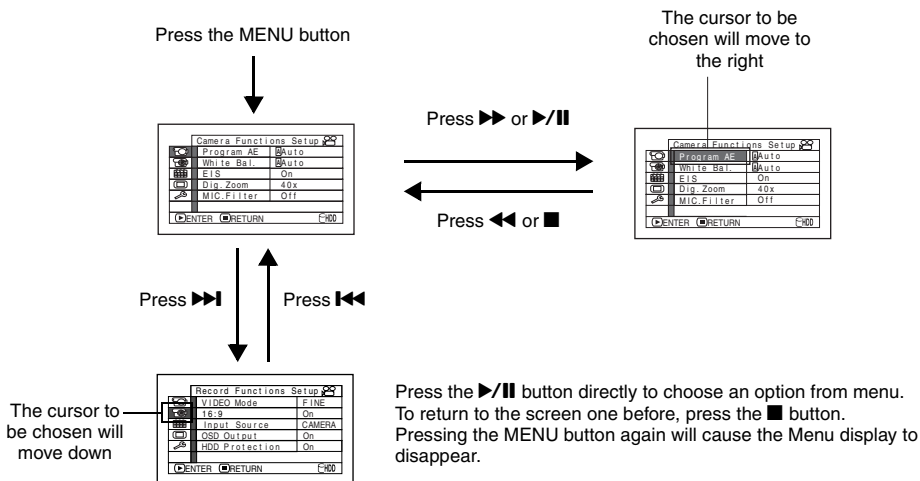
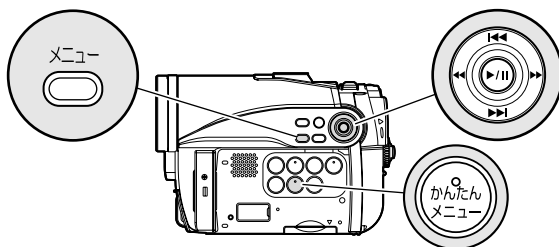

Note:

- Pressing the QUICK MENU button will display the Quick Menu screen: The operation will be the same as when the MENU button is pressed.
- Pressing the MENU button during recording will not display the menu.
- The menu screen will disappear when it is left for approx. one minute without any operation.

● Flow of Full Menu

■ The shaded menu item can also be set using the Quick Menu.
Refer to page indicated for details of each function.

Camera Functions Setup

Not displayed when external input is being selected.

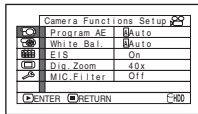

Camera Functions Setup	
Program AE	Auto
White Bal.	Auto
EIS	On
Dig. Zoom	40x
MIC Filter	Off
[ENTER] [RETURN] F100	

Program AE (p. 60)

White balance (p. 61)

EIS*1 (p. 63)

Digital zoom (p. 53)

Flash*2

Microphone filter*1 (p. 63)

*1: Not displayed in “SD” status.

*2: Displayed when DZ-HS403 is recording a photo.

Record Functions Setup

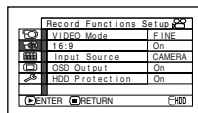

Record Functions Setup	
VIDEO Mode	FINE
16:9	On
Input Source	CAMERA
OSD Output	On
HDD Protection	On
[ENTER] [RETURN] F100	

Movie quality*3 (p. 64)

16:9*4 (p. 65)

Input selection (p. 67)

External still input*5 (p. 68)

Self-timer*6 (p. 68)

On-screen information display output*7 (p. 69)

HDD protection*8 (p. 69)

*3: The quality mode is not displayed in “SD” status (p. 67).

*4: Not displayed in “SD” status, or with external input.

*5: Displayed in “SD” status, and input selection is set to external signal.

*6: Displayed in “SD” status.

*7: Displayed only when input selection is set to camera.

*8: Displayed only in “HDD” status.

Date Setup

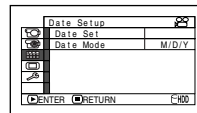

Date Setup	
Date Set	
Date Mode	M/D/Y
[ENTER] [RETURN] F100	

Date setting (p. 35)

Display format (p. 36)

LCD/EVF Setup

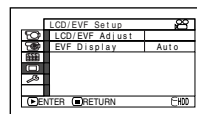

LCD/EVF Setup	
LCD/EVF Adjust	
EVF Display	Auto
[ENTER] [RETURN] F100	

Adjust (p. 38)

EVF Display (p. 39)

Initial Setup

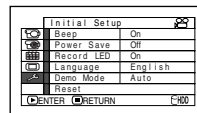

Initial Setup	
Beep	On
Power Save	Off
Record LED	On
Language	English
Demo Mode	Auto
Reset	
[ENTER] [RETURN] F100	

Beep (p. 36)

Power save (p. 36)

Recording LED (p. 37)

Language selection (p. 35)

Demo mode (p. 37)

Reset (p. 37)

Zooming

If you continue to hold the zoom lever on the "T" control side with Dig. Zoom specified, the digital zoom will be activated midway (when optical 10-power is exceeded on DZ-HS403 or optical 15-power is exceeded on DZ-HS401). You can zoom up to 240-power on DZ-HS403; up to 500-power on DZ-HS401.

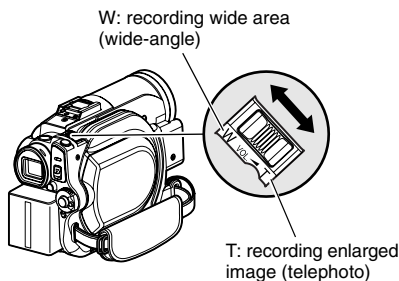

- 1 Press the MENU button, choose "Dig. Zoom" on the "Camera Functions Setup" menu screen, and then press the ►/|| button.

MACRO RECORDING

Use the macro function when recording a small object from close-up position: You can shoot the subject as close as approximately 2 cm from the lens surface, magnifying the image to fill the screen.

- 1 Aim the DVD video camera/recorder at the subject, and press the zoom lever to "W" control side.

- 2 Choose the desired magnification, and then press the ►/|| button.

- 3 Press the MENU button to end the setting.

Moving the zoom lever will display the digital zoom bar.

Note:

- The digital zoom setting will be stored in memory even if the DVD video camera/recorder is turned off.
- You can also use the DIGITAL ZOOM button on remote control to switch the digital zoom setting: Pressing the button during movie recording will switch the setting between "Off", "40x"^{*1}, and "240x"^{*2}: Pressing the button during photo recording will switch between "Off" and "40x"^{*1}.
- If you set zoom to "240x"^{*2} when recording photo, the digital zoom will be up to 40x^{*1}.
- When a subject is zoomed, it may be momentarily out of focus.
- When digital zoom is engaged, the image quality will be rougher.

^{*1} "60x" on DZ-HS401.

^{*2} "500x" on DZ-HS401.

Note:

- Zoom can be used, but the subject may not be focused, depending on the distance to the subject. In this case, move the zoom to "W" control side to focus.
- The amount of light tends to be insufficient during macro recording: If the subject image is too dark, use additional lighting.

RECORDING SUBJECTS FOR STRONGER WIDE-ANGLE OR TELEPHOTO EFFECT

Use the tele-conversion lens or wide-conversion lens with the following filter diameter and thread pitch to record subjects for stronger telephoto or wide-angle effect:

Filter diameter: 37 mm for DZ-HS403; 30.5 mm for DZ-HS401

Thread pitch: 0.75 mm for DZ-HS403; 0.5 mm for DZ-HS401

When attaching the optional DZ-TL1 tele-conversion lens or DZ-WL1 wide-conversion lens, use the optional step-up ring: DZ-SR3037 for DZ-HS401 (see page 141).

1 Remove the lens hood from DVD video camera/recorder, and attach the step-up ring over the lens.

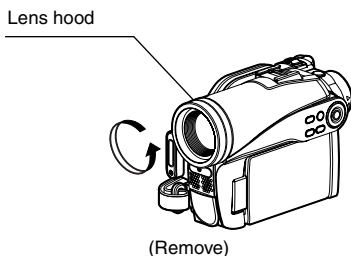

2 Remove the cap of conversion lens, and screw the lens into the thread of step-up ring. When using the DZ-HS403, you need not use the step-up ring.

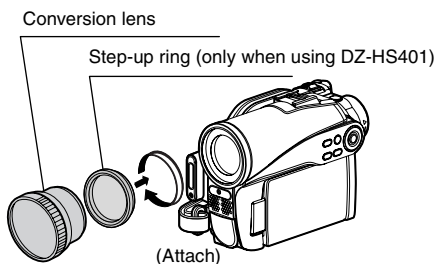

- Tele-conversion lens: For stronger telephoto effect
- Wide-conversion lens: For stronger wide-angle effect

Note:

- Be careful not to lose the removed lens hood.
- With DZ-TL1 tele-conversion lens, the focusing range at "T" (telephoto) control side is between approx. 5 m and infinite.
- When a conversion lens is attached, note that the four corners of screen will be slightly dim if you zoom in on a subject on the W control side (wide-angle side).
- When replacing the lens, take care not to drop the DVD video camera/recorder.
- Attaching the conversion lens will disable the function of the built-in flash (for DZ-HS403 only): Specify "Flash: Off" (see page 58).
- If a generally available filter is attached, do not attach the removed lens hood.
- Some generally available conversion lenses may not be usable on this DVD video camera/recorder, depending on the lens maker.

Manually Focusing Subject

The DVD video camera/recorder usually focuses on a subject automatically (autofocus). You can also manually focus a subject depending on the recording conditions.

FOCUSING DURING RECORDING

Normally, the DVD video camera/recorder automatically focuses the subject (autofocus), but you can also manually focus a subject, depending on the recording conditions (manual focus).

Focusing range:

You can switch the display mode of on-screen information:

- On T (tele) side: approximately 1 m from lens surface to infinity
- On W (wide) side: approximately 2 cm from lens surface to infinity

1 Press the FOCUS button during recording.

Manual Focus icon will appear on the screen.

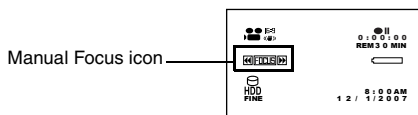

2 Press the zoom lever to "T" control side to zoom in on subject.

3 Use the ◀▶ buttons to adjust the focus, while viewing the image in the viewfinder or on the LCD screen.

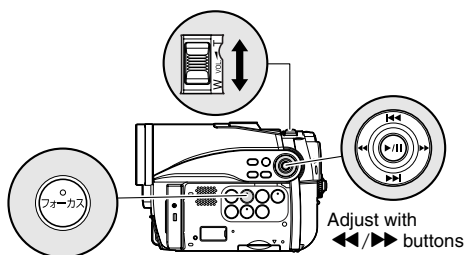

Note:

- Pressing FOCUS will alternate between manual focus and auto focus. With auto focus, no indication will appear on the screen.
- Be sure to zoom in on your subject before manually focusing on it. If you bring the subject into focus at the "W" control side, focus will be faulty when you turn the zoom lever to the "T" control side to zoom in on the subject.
- Manual focus is released when the DVD video camera/recorder is turned off. When you turn the DVD video camera/recorder on next time, auto focus will be restored.

Manually focus the following objects, which may not be automatically focused (see page 55):

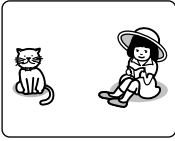

Objects not in the center of screen

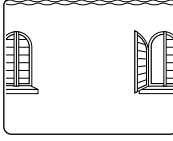

Objects with little variation in brightness, such as white wall



Objects that are far and near at the same time



Objects moving rapidly



Objects lit by neon sign, spotlight, etc. which glares or emits strong light



Dark objects

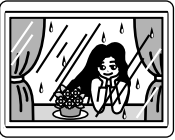

Object behind glass with water droplets, dirt on it



Night view

Adjusting Brightness of Image to be recorded (Exposure)

The DVD video camera/recorder usually adjusts the exposure automatically. You can also manually adjust the exposure depending on the recording conditions.

- 1 Press the EXPOSURE button during recording.

The exposure adjustment bar will appear on the screen.

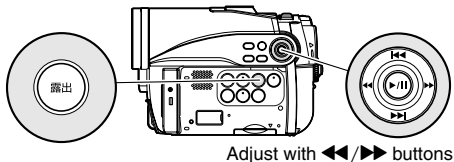
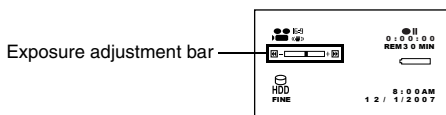

- 2 Use the <</> buttons to adjust the exposure, while viewing the image in the viewfinder or on the LCD screen.

Note:

- Pressing EXPOSURE will alternate between manual adjustment and auto exposure. With auto exposure, no indication will appear on the screen.
- The exposure setting will return to Auto when the DVD video camera/recorder is turned off.

Compensating for Backlight

When subject is lighted from rear, this function will compensate for lighting so that the subject is not too dark.

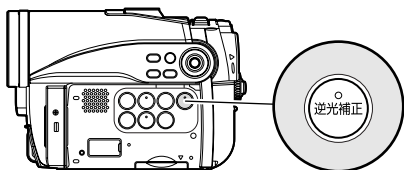

- 1 Press the BLC button during recording.

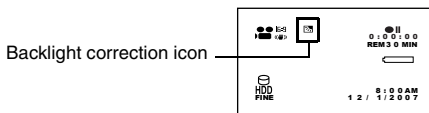

The backlight correction icon will appear.

Note:

- Pressing the BLC button will alternate between backlight setting between on and off.
- The backlight setting will automatically return to "off" when the DVD video camera/recorder is turned off.

Built-in Video Flash (for DZ-HS403 only)

When recording photos in a dark place, or if the subject is lit from rear, the DZ-HS403 makes use of the built-in Video Flash for automatic brightening: The Video Flash can also be set to On where the light is always being emitted, or Off when you wish to record without using the flash even in a dark place.

Setting	On-screen display	Manner of emitting light
Auto	⚡ when the PHOTO/SELECT button is pressed	Automatically emits light in dark place or in a spot lit from rear.
On	⚡	Always emits light regardless of brightness.
Off	⚡	No light emission.

- 1 Press the MENU button, and choose “Flash” from the “Camera Functions Setup” menu.
- 2 Choose the option for “Flash” and decide it.
- 3 Press the MENU button to end the setting.

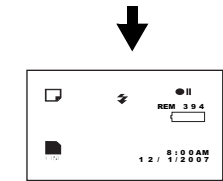
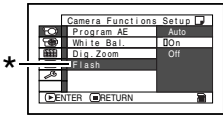

* Displayed when using DZ-HS403 to record photo (not displayed when the optional Video Flash is connected).

- If you continuously record using the Flash, the Flash may not emit light or the amount of light may not be adjustable. After recording using the Flash, it is recommended that you wait for a few moments, before pressing the PHOTO/SELECT button to record.
- “⚡” will blink during charging of the battery for Video Flash.
- While “⚡” is flashing, the video flash will not emit light, though the DVD camera/recorder is recording.
- When recording a close-up photo, specify “Flash: Off”. Using the flash too near subject could cause a whitish image.
- Do not use the Video Flash when approaching the human eye. Emitting light from Video Flash near human eye could damage the subject’s eyesight. Especially when recording a baby or small child, move the DVD video camera/recorder at least 1 m away.
- Do not use the Video Flash while pointing it at a driver in vehicle: Doing so could dazzle the driver, causing an accident.
- Do not use the Video Flash in a place where there is flammable or explosive gas: Doing so could cause fire or explosion.

Note:

- The built-in Video Flash setting will not change even when the DVD video camera/recorder is turned off. Unless recording is to be made with the fixed Flash setting, it is recommended to return it to “Auto” after recording with the “On” or “Off” setting, before turning the DVD video camera/recorder off.
- When recording dark subjects, the shutter speed will be slower, so don’t let the camera shake.
- However, dark subjects may not be in clear focus even if the Video Flash is used. It is recommended that you light a subject when recording in a dark place.
- The Video Flash built into DZ-HS403 cannot be used when a conversion lens is attached: Specify “Flash: Off”
- The distance for the built-in Video Flash to adjust the appropriate amount of light will vary depending on the subject, but it is approximately 1 – 2.5 m.
- The Video Flash automatically adjusts the amount of light emitted, but the light amount adjustment may be insufficient when a subject is too far away or too near.

Using Full Auto Function

Pressing the FULL AUTO button will fully automate the camera functions.

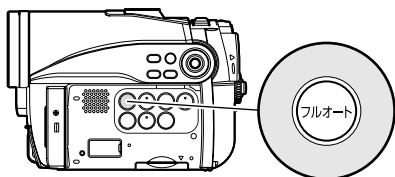

1 Press the FULL AUTO button.

“FULL AUTO” will be displayed on the screen of DVD video camera/recorder for several seconds.

The following settings will reset to defaults:

Function	When setting full auto	Reference page
Focus	Auto	55
Backlight compensation	Off	57
Exposure	Auto	57
Program AE	Auto	60
White balance	Auto	61
EIS	On	63
MIC.Filter	Off	63

Setting Up Camera Functions

Before You Begin

- See page 51 for how to set.
- No menu screen appears with external input.

SELECTING SHOOTING MODE TO MATCH THE SUBJECT (SWITCHING PROGRAM AE MODE)

This DVD video camera/recorder automatically detects the status of subject and surrounding situation and records the optimum image: If you choose the shooting mode to match the recording conditions, clearer images will be recorded.

- 1 Press the MENU button, use the **◀◀/▶▶/▶▶/▶▶** buttons to choose "Program AE" on the "Camera Functions Setup" menu screen, and then press the **▶/||** button.

The options will appear on the right of "Program AE".

- 2 Use the **◀◀/▶▶/◀◀/▶▶** buttons to choose the desired option, and then press the **▶/||** button: The selected option will be set.

- 3 Press the MENU button to end the setting.

The menu screen will disappear.

Note:

- You can check the selected AE mode by the on-screen information display. However, nothing will appear in the Auto mode.
- The shooting mode set as above will be stored in memory even if the DVD video camera/recorder is turned off.
- When recording in a dark area, an after-image will appear when filming a moving subject or if camera shake occurs (it is therefore recommended that you use a tripod in such cases).
- If the Sports mode is used under a fluorescent light, the image may flicker: In this case, use the Auto mode for recording.

A Auto : The camera/recorder automatically judges the subject and surrounding environment for optimum recording.

🏏 Sports : Reduces blurring when recording rapidly moving subjects such as in golf or tennis.

👤 Portrait : Makes a subject, such as a person or a creature, stand out from a blurred background.

📷 Spotlight : Prevents overexposure of subject portrait face, etc. when strong light strikes the subject, as in a wedding or on stage.

☁ Sand & Snow : Prevents underexposure of subject portrait face, etc. in a place where reflection of light is intense, such as at the seaside in midsummer or on a ski slope.

📷 Low Light : Allows user to record in a dark place even with decreased lighting.

Turn the LCD monitor 180° during recording: The LCD monitor light can then be used for recording.

RECORDING DARK SUBJECTS USING LCD MONITOR LIGHT

When Program AE is set to Low Light, you can use the light from LCD monitor to record a subject.

1 Press the MENU button, use the **◀◀/▶▶/▶▶/▶▶** buttons to choose "Program AE" on the "Camera Functions Setup" menu screen, and then press the **▶/||** button.

2 Use the **◀◀/▶▶/▶▶/▶▶** buttons to choose "Low Light", and then press the **▶/||** button.

3 Press the MENU button to end the setting.

4 Open the LCD monitor, turn it 180° so that it faces the same direction as the lens: The LCD monitor will light white.

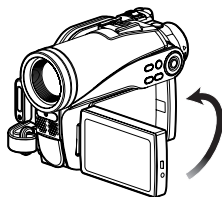

Note:

- Use the viewfinder to check the image to be recorded.
- The LCD monitor light allows you to record a subject up to 1 m even in a dark place.
- An after-image will appear when filming a moving subject or if camera shake occurs (it is recommended that you use a tripod).
- If a subject cannot be focused properly, manually adjust the focus (see page 55).

ADJUSTING COLOR (WHITE BALANCE)

This DVD video camera/recorder automatically adjusts the color of subject. Change the white balance setting depending on the recording conditions.

Mode	Setting content	On-screen display
Auto	White balance always automatically adjusted	None
Set	You can manually adjust white balance to match the light source or situation (p. 62)	
Outdoor	To record in fine weather	
Indoor 1	To record under incandescent light, halogen light or bulb-color type fluorescent light	
Indoor 2	To record under fluorescent light	

- 1 Press the MENU button, use the **◀◀/▶▶/◀/▶** buttons to choose "White Bal." on the "Camera Functions Setup" menu screen, and then press the **▶/||** button.
- 2 Choose the desired option, and then press the **▶/||** button.
- 3 Press the MENU button to end the setting.

Note:

- The white balance mode can be confirmed using the on-screen information.
- The white balance setting will be stored in memory even when the DVD video camera/recorder is turned off.
- Do not block the infrared sensor with hand, etc.

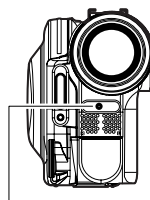

Infrared sensor block

- If a tele or wide-conversion lens is used, the auto white balance may not operate depending on the recording conditions. If this happens, set to the mode to match the recording conditions, or manually set the white balance.
- Be sure to remove the lens cap before turning the DVD video camera/recorder on: If the DVD video camera/recorder is turned on with the lens capped, the white balance will not work normally.

● Setting white balance manually

- 1 Point the DVD video camera/recorder at a white object so that it fills the screen. Use an object that is not transparent. If focus is not correct when the white object fills the screen, manually focus the object, referring to "Manually Focusing Subject" (see page 55).
- 2 Press the MENU button, use the **◀◀/▶▶/◀/▶** buttons to choose "White Bal.", "Set" on the "Camera Functions Setup" menu screen, and then press the **▶/||** button.
- 3 Hold **▶/||** button pressed until the "☑" indicator changes from blinking to a steady light. When the "☑" indicator lights, the white balance setting will be complete.

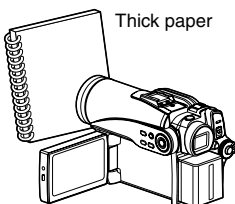

- 4 Press the **■** button to end the setting.

Note:

- The white balance set using the "Set" option will be stored in memory until it is re-set.
- Do not use a colored object when setting the white balance: The appropriate tint cannot be set.
- If "Input Source: LINE, S-LINE" has been specified, you cannot use the "Set" mode of white balance (p. 67) .
- The setting on white balance "Set" may not be possible in a dark place. Also, the white balance cannot be set when the zoom bar is in the digital zoom range (p. 53). In such status, the "☑" indicator will remain blinking. Set the white balance in a bright place with "Dig. Zoom: Off" specified.
- If the recording conditions have changed, re-set the white balance for appropriate colors.
- The setting will be stored in memory even when the DVD video camera/recorder is turned off: The "☑" indicator will blink when the DVD video camera/recorder is turned on next time. Re-set the white balance as needed.

USING THE ELECTRONIC IMAGE STABILIZER (EIS)

When you use zoom (see page 53) to record a magnified subject image, it will correct fuzziness in the recorded image.

1 Press the MENU button, use the **◀◀/▶▶/▶▶/▶▶** buttons to choose “EIS” on the “Camera Functions Setup” menu screen, and then press the **▶/||** button.

2 Choose the “On” or “Off”, and then press the **▶/||** button.

3 Press the MENU button to end the setting.

Note:

- You can check EIS On or Off by the on-screen information display.
- The EIS setting will be stored in memory even when the DVD video camera/recorder is turned off.

- After recording with EIS set to “Off”, it is recommended that you return the setting to “On” and then turn the DVD video camera/recorder off, unless you normally record with “Off” setting.
- It is recommended that you specify “EIS: Off” when using the DVD video camera/recorder on a desk or tripod.
- When “EIS: On” is specified, there will be a slight difference between the actual movement and the movement on screen.
- Gross camera shake may not be entirely corrected even if “EIS: On” is specified: Firmly hold the DVD video camera/recorder with both hands.
- EIS may not operate correctly when the tele or wide-conversion lens is used.
- EIS cannot be used when recording photos.

RECORDING SUBJECT USING LARGE MAGNIFICATION (DIGITAL ZOOM)

See page 53 for setting on digital zoom.

REDUCING WIND NOISE DURING RECORDING (MIC.FILTER)

When recording sound from the microphone built into this DVD video camera/recorder, you can reduce wind noise in recording.

If “MIC.Filter: On” is specified, the low-frequency components in the sound picked up by microphone will be cut off during recording: This makes it easier to hear the target voice or sound during playback.

1 Press the MENU button, use the **◀◀/▶▶/▶▶/▶▶** buttons to choose “MIC.Filter” on the “Camera Functions Setup” menu screen, and then press the **▶/||** button.

2 Choose the desired option, and then press the **▶/||** button.

3 Press the MENU button to end the setting.

Note:

- You can also use the on-screen display to confirm that the MIC.Filter has been set.
- The MIC.Filter setting will be stored in memory even when the DVD video camera/recorder is turned off.
- The MIC.Filter function will work only during movie recording.
- The microphone filter function works only with the built-in microphone: It will not function when using an external microphone (p. 70).

Setting Up Record Functions

HDD RAM RW VR RW VF R +RW

SWITCHING MOVIE QUALITY (VIDEO MODE)

Choose the movie quality from “XTRA”, “FINE”, “STD”.

It is recommended that you record critical subjects in the “XTRA” or “FINE” mode.

1 Press the MENU button, use the **◀◀/▶▶/◀◀/▶▶/▶/||** buttons to choose “VIDEO Mode” on the “Record Functions Setup” menu screen, and then press the **▶/||** button.

2 Choose the desired quality mode, and then press the **▶/||** button.

3 Press the MENU button to end the setting.

Note:

- The movie quality setting will be stored in memory even when the DVD video camera/recorder is turned off.
- The “VIDEO Mode” setting will not change even if the DVD is replaced.
- When using DVD-RW (VF-mode)/DVD-R, you cannot switch the setting on movie quality or wide-screen mode while recording on the disc: The DVD video camera/recorder will be automatically set to the movie quality or wide-screen mode first used with the disc for recording.
- When using a DVD-RW (VF-mode)/DVD-R/+RW: You cannot specify the combination of “VIDEO Mode: STD” and “16:9 On”(p. 84). If you specify “16:9 On” and try to switch the VIDEO Mode to STD from XTRA or FINE, the screen will automatically switch to the 4:3-aspect ratio display.
- The movie quality setting is effective only during movie recording: The setting will not be displayed during recording of stills.

Block-like noise may appear in recorded image, or the outline of subject image is distorted under the recording conditions listed below. Pan the DVD video camera/recorder as slowly as possible (Block noise is likely to appear in the “STD” mode):

- If there is a complicated pattern in background (as in following figure on left);
- If the DVD video camera/recorder is moved excessively or quickly;
- If subject is moving rapidly even when the DVD video camera/recorder is not moving.

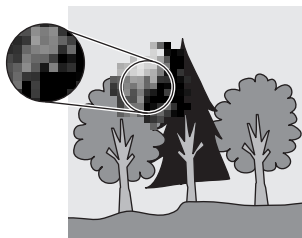

(Image when block-like noise occurs)



(Image without block-like noise)

SETTING TO WIDE TV SCREEN MODE (16:9 MODE)

When viewing recorded images later on a wide-screen TV (aspect ratio 16:9), specify wide-screen (16:9) mode "On": You can also record images with the aspect ratio changed (the aspect ratio with "Off" is 4:3).

The following figures compare the images displayed on LCD monitor and in viewfinder when the wide-screen mode is "on" and "off".

"16:9 On" specified
(aspect ratio 16:9)

"16:9 Off" specified
(aspect ratio 4:3)

When using DZ-HS403

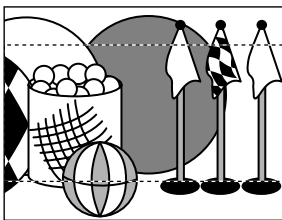
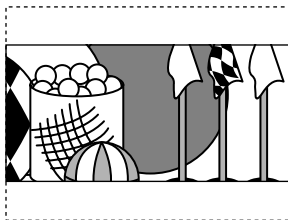

When using DZ-HS401

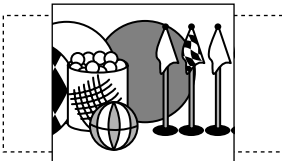
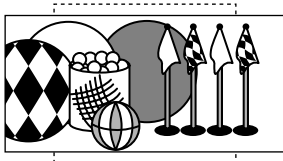

- 1 Press the MENU button, use the **◀◀/▶▶**/**◀/▶** buttons to choose "16:9" on the "Record Functions Setup" menu screen, and then press the **▶/||** button.
- 2 Choose "On", and then press the **▶/||** button.
- 3 Press the MENU button to end the setting.

When viewing playback on an ordinary TV screen later, specify "16:9 Off": Recording with "16:9 On" specified will be played back on an ordinary TV with longer vertical direction of image.

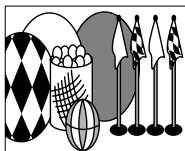

An image recorded with "16:9 On" specified will appear as follows:

Display on LCD monitor screen

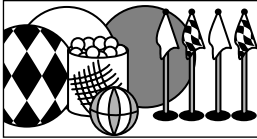

Display in viewfinder

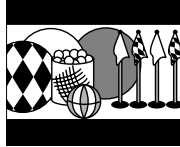

Images recorded with "16:9 Off" specified will appear as follows:

Display on LCD monitor screen

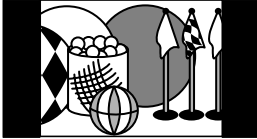

Display in viewfinder

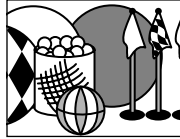

Note:

- The 16:9 setting will be kept even after the DVD video camera/recorder is turned off.
- The 16:9 mode cannot be used with photo recording, external input.
- When using a DVD-RW (VF-mode)/DVD-R/+RW:
You cannot specify the combination of "VIDEO Mode: STD" and "16:9 On" (p. 84). If you specify "16:9 On" and try to switch the VIDEO Mode to "STD" from "XTRA" or "FINE", the screen will automatically switch to the 4:3-aspect ratio display.
- Once the DVD-RW (VF-mode)/DVD-R disc has been recorded in the wide-screen mode, you will not be able to switch to recording of external input using the same disc.
- When using DVD-RW (VF-mode)/DVD-R, switching between wide mode (16:9) and normal mode (4:3) will not be possible while using the same disc.
- Images recorded with "16:9 On" (aspect ratio 16:9) specified will be played back with the setting used during recording regardless of the 16:9 setting then being used.
- The 16:9 setting is not compatible with ID-1/ID-2*.
- If you connect this DVD vide camera/recorder to the S1 or S2 terminal of TV, the TV will automatically switch to the wide-screen mode: See TV instruction manual for details.
- When using a video selector, the TV may not automatically be switched to 16:9 mode.
- If you connect the DVD video camera/recorder with a disc recorded in wide mode to a TV with 4:3 display only and play it back, vertically long images will appear. To display 4:3 images, set "TV type" (p. 115) to 4:3 and view the images.
- If you play back a +RW recorded in wide mode on a DVD recorder/player, etc., vertically long images will appear even on a wide-screen TV. In this case, change the setting on the DVD recorder/player, or set "TV type" (p. 115) to 4:3 and view the images.

* This system records the aspect ratio (16:9, 4:3) information in void space between video signals.

SWITCHING QUALITY OF STILL IMAGE (QUALITY)

You can switch the still recording quality.

It is recommended that you use “FINE” when recording vital images (p. 160 “Size And Quality Of Photos”).

1 Press the MENU button, use the **◀◀/▶▶/◀◀/▶▶/▶/||** buttons to choose “Quality” on the “Record Functions Setup” menu screen, and then press the **▶/||** button.

2 Choose the option you want, and then press the **▶/||** button.

3 Press the MENU button to end the setting.

Note:

- The still quality setting will be stored in memory even when the DVD video camera/recorder is turned off.

HDD RAM RW VR RW VF R +RW CARD

RECEIVING IMAGE FROM ANOTHER DEVICE (INPUT SOURCE)

If you wish to input an image from another device to this DVD video camera/recorder, you must first switch the setting on the DVD video camera/recorder.

Refer to the explanation starting from page 119 on how to connect the DVD video camera/recorder to other devices or record images input from them.

Setting	Content	On-screen display
CAMERA	Usually select this option	No display
LINE	To input image from another device	L IN
S LINE	To input S-VIDEO signal from another device	S IN

1 Press the MENU button, use the **◀◀/▶▶/◀◀/▶▶/▶/||** buttons to choose “Input Source” on the “Record Functions Setup” menu screen, and then press the **▶/||** button.

2 Choose “LINE”, and then press the **▶/||** button.



3 Press the MENU button to end the setting.

Note:

- The “Input Source” setting will return to “CAMERA” whenever the DVD video camera/recorder is turned off.

SWITCHING EXTERNAL INPUT RECORDING METHOD (PHOTO INPUT)

When "Input Source: LINE, S-LINE" is specified, you can record stills of externally input images on a card. The DVD video camera/recorder can record an external image with little movement by specifying "Frame", but "Field" is recommended for recording image with movement.

Recording format	Details of setting	On-screen display
Frame	Does not suit recording of frequently moving video subjects, despite high image quality. Frame suits recording of less moving video.	
Field	Suitable for recording of frequently moving video subjects.	

- 1 Press the MENU button, use the **◀◀/▶▶/◀/▶/▶/||** buttons to choose "PHOTO Input" on the "Record Functions Setup" menu screen, and then press the **▶/||** button.
- 2 Select the desired option and then press the **▶/||** button.
- 3 Press the MENU button to end the setting.

Note:

- The PHOTO Input setting can be confirmed using the on-screen information.
- The PHOTO Input setting will be stored in memory even when the DVD video camera/recorder is turned off.
- Refer to "Recording (Dubbing) Images", page 119 to see how to connect the DVD video camera/recorder to another device.

SELF-TIMER

You can record photos using the self-timer function, as with ordinary cameras.

The self-timer function is valid only when recording photos (stills).

- 1 Press the MENU button, use the **◀◀/▶▶/◀/▶/▶/||** buttons to choose "Self Timer" on the "Record Functions Setup" menu screen, and then press the **▶/||** button.
- 2 Select "On", and then press the **▶/||** button.
The self-timer will be set.
- 3 Press the MENU button to end the setting.
- 4 Press the PHOTO/SELECT button.

The recording indicator at the front of DVD video camera/recorder will blink.
The self-timer indicator will start to count down, and recording will commence approximately 10 seconds later.

Note:

- You can also check that self-timer has been set by reviewing the on-screen information.
- To release the self-timer mode, choose "Off" on the menu screen or turn DVD video camera/recorder off.
- To suspend self-timer, press the PHOTO/SELECT button again before recording starts, or press the **■** button.

SETTING ON-SCREEN DISPLAY OUTPUT ON OR OFF (OSD OUTPUT)

If you connect this DVD video camera/recorder to a TV to view images on TV screen, you can switch off the on-screen information (displayed in the viewfinder or on the LCD screen) from the TV screen.

- 1 Press the MENU button, use the **◀◀/▶▶/▶▶/▶▶/▶▶/▶▶** buttons to choose "OSD Output" on the "Record Functions Setup" menu screen, and then press the **▶▶/▶▶** button.
- 2 Choose "On" or "Off", and press the **▶▶/▶▶** button.
- 3 Press the MENU button to end the setting.

Note:

- The "OSD Output" setting will be stored in memory even when the DVD video camera/recorder is turned off.
- Even if "Off" is chosen, the on-screen information will appear during playback. See page 78 for playback on-screen information display.
- Even after the on-screen information is removed from the TV screen, it will still appear in the viewfinder or on the LCD screen.
- The on-screen display output functions only when the input selection is set to camera: It cannot be set during external input.

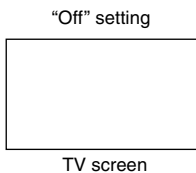
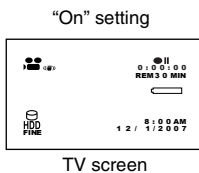

DROP DETECTION (HDD PROTECTION)

The default setting is "On". Specify "HDD Protection: Off" if you plan to use the HDD built in this DVD video camera/recorder in a weightless condition, such as skydiving, to prevent stop in recording or playback: Specifying "On" in such status will activate the drop detection function and stop recording or playback to protect the HDD built in this DVD video camera/recorder.

- 1 Press the MENU button, use the **◀◀/▶▶/▶▶/▶▶/▶▶/▶▶** buttons to choose "HDD Protection" on the "Record Functions Setup" menu screen.
 - 2 Choose "On" or "Off", use the **◀◀/▶▶/▶▶/▶▶/▶▶/▶▶** buttons to then press the **▶▶/▶▶** button.
- When "Off" is specified, the icon will appear.

Note:

- The "HDD Protection" setting will return to "On" when the DVD video camera/recorder is turned off.

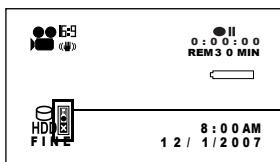

An icon will appear.

(When "HDD Protection: Off" is specified)

Using External Microphone

Connect external microphone (generally available) to the external microphone jack of this DVD video camera/recorder. Clearer sound can be recorded. Turn on the switch on external microphone and start recording. For details on external microphone, see "Major Specifications" on page 157.

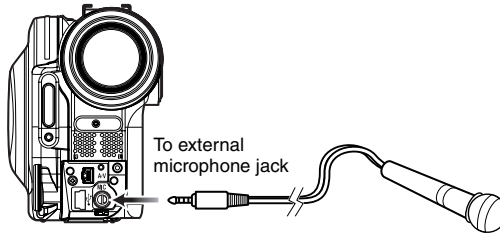

Note:

- Depending on the shape of its plug, an external microphone cannot be plugged in, while the cable is left plugged in the AV/S input/output terminal. Unplug the AV/S input/output cable to use the external microphone.
- This DVD video camera/recorder cannot use a plug-in power type microphone. (Power is not supplied from this DVD video camera/recorder.)
- Connecting an external microphone will switch off the built-in microphone.

Using Disc Navigation

STARTING OR TERMINATING DISC NAVIGATION

Disc Navigation is a tool for editing scenes recorded on this DVD video camera/recorder.

Here is an explanation on “scene” and “program”, so that you will be able to make most use of Disc Navigation function.

The screens in this instruction manual are basically those that will appear when the HDD is used: Some items will not appear when a DVD-RAM/DVD-RW/DVD-R/+RW or card is used, but the operation is the same.

Before You Begin

- Turn the DVD video camera/recorder on (p. 33).
- When using HDD: Set the power switch to “HDD”.
- When using DVD: Set the power switch to “DVD”.
- When using card: Set the power switch to “SD”.

1 Set the power switch properly.

2 Press the DISC NAVIGATION button.

The Disc Navigation screen (shown on page 72) will appear.

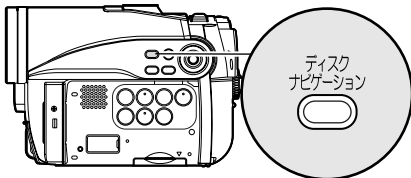

3 Press the DISC NAVIGATION button again.

Disc Navigation will be terminated and the DVD video camera/recorder will enter the recording pause status.

You can also press the ■ button to end Disc Navigation.

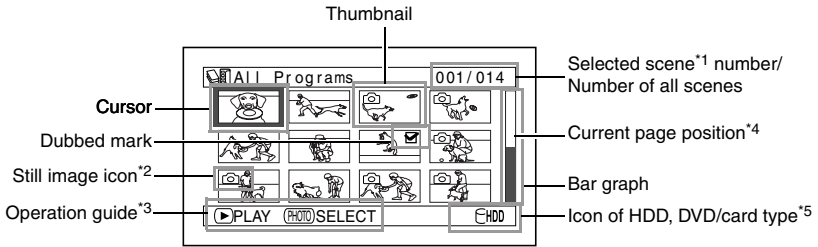

***1 Scene:**

Video (movie)..... "One scene" refers to images recorded from one press of REC button until recording is stopped by pressing the REC button again.

Photo (still)..... "One scene" refers to a single photo recording by pressing the PHOTO/SELECT button.

***2** Icon displayed on a photo recorded on a DVD-RAM using a Hitachi DVD video camera/recorder that can record photos on a DVD-RAM.

This DVD video camera/recorder cannot record any photos on a DVD-RAM.

***3** The operation guide will vary depending on the operation status of DVD video camera/recorder.

***4** Appears when 13 scenes or more have been recorded.

***5** When using a disc, the icon that corresponds to the type of disc being used will appear. "HDD" will appear for card.

Icons to be displayed on thumbnail:

..... Dubbed mark (p. 85)

..... Photo (p. 44)

..... Fade-in (p. 92)

..... Skip (p. 93)

..... Fade-out (p. 92)

..... Lock (p. 96)

Note:

- Each time the DISPLAY button is pressed, the recording date/time of the scene on which the cursor is placed, recording data of scene (VIDEO Mode, 16:9, recording length), and operation guide will appear in sequence (when HDD is used).

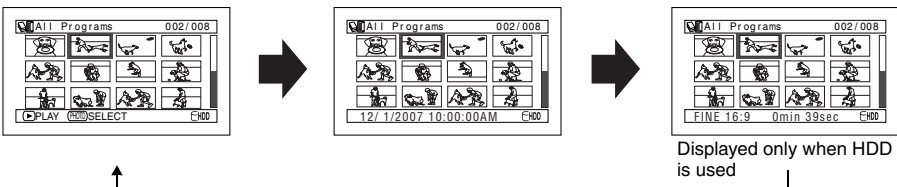

- Each time Disc Navigation is started with a DVD-RW (VF-mode)/DVD-R/+RW inserted, message "Creating Thumbnail .." will appear. After the message appears, the Disc Navigation screen will appear.
- In the following cases, the Disc Navigation screen will appear or a message will be displayed:
 - HDD or disc is write-protected
 - Finalized DVD-RW (VF-mode)/DVD-R/+RW
 - DVD-RW (VF-mode)/DVD-R recorded on a Hitachi DVD video camera/recorder model marketed before this DVD video camera/recorder, and not finalized
 - Locked card
- Do not leave the Disc Navigation screen displayed on TV to which the DVD video camera/recorder is connected: Doing so could damage the TV screen, possibly by burning.

PLAYING BACK FROM DISC NAVIGATION SCREEN

- 1 Press the DISC NAVIGATION button.
- 2 Use the ◀◀/▶▶/◀/▶ buttons to select the desired scene.

The selected scene will be framed: This is called a “cursor”.

- 3 Press the ▶/|| button.

Playback will start from the selected scene.

Note:

- Pressing the ◀◀ or ▶▶ button will move the cursor to the preceding or following scene. Pressing the ◀ or ▶ button will move to preceding or following page.
- If there is a large number of recorded scenes, it may take time more than usual until playback of scenes starts.

ADJUSTING VOLUME DURING PLAYBACK

If the LCD monitor is open during playback of movie, playback sound will be heard from the speaker. Adjust the sound volume using the zoom lever. Tilt it to the “T” side to increase the volume, “W” side to reduce the volume.

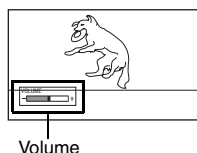
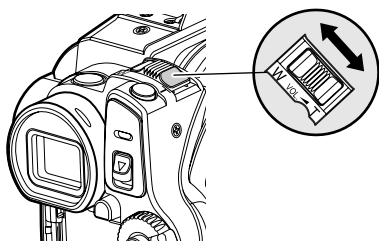

●When playback ends

The DVD video camera/recorder will enter the playback pause status at the last image of last scene. Pressing the ■ or DISC NAVIGATION button will restore the Disc Navigation screen.

When the playback pause status continues for as long as 5 minutes, the Disc Navigation screen will automatically be restored.

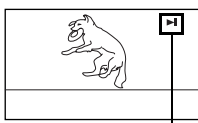

Playback pause

●Playing back photos

A photo on DVD-RAM will be displayed for approx. 3 seconds. When playing back photos on card, playback will stop after each photo playback.

Note:

- Press the ▶/|| button to temporarily stop playback. Pressing the ▶/|| button again will start from that point.
- If you press the ▶/|| button after playback of the last scene on disc finishes, playback will start again from the beginning.
- Pressing the ■ button will always restore the Disc Navigation screen.
- When playing back photos on card, “Playback” will appear. In the case of a photo with a large number of pixels, it will take some time for the photo to appear.

Before You Begin

- Insert a disc or card recorded on this DVD video camera/recorder to play back scenes on it. (p. 43, 44).
- Turn the DVD video camera/recorder on (p. 33).

HDD RAM RW VR RW VF R +RW CARD

PLAYING BACK LATEST RECORDED SCENE

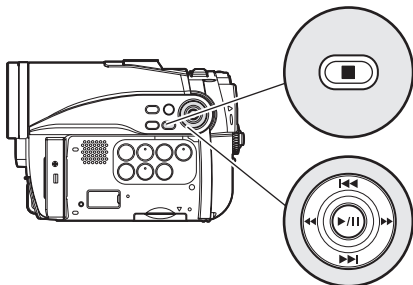

- 1 Press the ►/|| button in the recording pause status.

The DVD video camera/recorder will enter the playback mode, and the scene you have recorded last will be played back.

When playback is finished, the DVD video camera/recorder will enter the pause status at the last image on disc.

If the playback pause status continues for as long as 5 minutes, the DVD video camera/recorder will automatically return to the recording pause status.

- 2 Press the ■ button.

Playback will stop, and recording pause status will be restored.

DELETING LAST RECORDED SCENE

- 1 Press the MENU button during playback.
- 2 Choose "Edit", "Delete Scene", and then press the ►/|| button.
The screen for verifying deletion will appear.

Note:

- To temporarily stop playback, press the ►/|| button. Press the ►/|| button again to restart playback.
- Even if you stop playback midway and immediately start recording again, the new image will be recorded after the last scene on HDD, disc or card (the previous images will not be overwritten).
- Image data edited on PC, etc., or the recorded image may not appear on this DVD video camera/recorder; also, the recorded sound may not play back, depending on the type of image data.
- Image data recorded on another DVD video camera/recorder or DVD recorder may not be played on this DVD video camera/recorder.
- Depending on the amount of data to be played back, it may take some time for the playback image to appear.
- Do not operate the power switch or remove the card while the ACCESS/PC or CARD ACCESS indicator is lit or blinking: Doing so may damage the card or the data on card.
- If the temperature of this DVD video camera/recorder is too high, normal playback may not be possible: Turn the DVD video camera/recorder off once, wait until the ambient temperature becomes lower, and then operate it again.

HDD RAM RW VR +RW CARD

- 3 Choose "YES", and then press the ►/|| button.
The last recorded scene will be deleted, and the recording pause status will be restored.

Note:

- If you press the MENU button during playback using the Disc Navigation menu, "Delete Scene" will not appear.

CAPTURING PHOTO

You can record an image displayed during playback of video as a photo on a card.

- 1 Press the MENU button at a scene you wish to capture during playback.
- 2 Choose "Edit", "PHOTO Capture", and then press the ►/|| button.
The screen for verifying capture will appear.
- 3 Choose "YES", and then press the ►/|| button.
The captured scene will be recorded on a card.

Note:

- You can also press PHOTO/SELECT button for the scene you wish to capture in step 1: The screen for verifying capture will appear. Choose "YES", and then press the ►/|| button. The scene will be recorded on a card.
- A captured photo is played back on the DVD video camera/recorder as follows:
When captured from a video recorded with 16:9 (wide mode) On specified:
Number of pixels (JPEG standard): 640 x 360



- When captured from a video recorded with 16:9 (wide mode) Off specified:
Number of pixels (JPEG standard): 640 x 480



SEARCH PLAYBACK OF MOVIE

During playback, press the ◀◀ or ▶▶ button and hold it: Search playback will start.

Hold down ▶▶ :

Scenes will be visually scanned forward.

Hold down ◀◀ :

Scenes will be visually scanned backward.

Release the ◀◀ or ▶▶ button when you find the desired image:

Normal playback will start from that point.

Note:

- If the temperature inside the DVD video camera/recorder rises, normal skip or search playback may not be possible: Turn the DVD video camera/recorder off, wait for a few moments, and then turn it on again.

FRAME ADVANCE/FRAME BACK/SLOW PLAYBACK OF MOVIE

During playback pause, press the ◀◀ or ▶▶ button: Frame advance, frame back or slow playback will start.

Press ▶▶ once:

Picture will advance one frame.

Press ◀◀ once:

Picture will go back one frame.

Hold down ▶▶ :

Forward slow playback.

Hold down ◀◀ :

Reverse slow playback.

After frame advance, frame back or slow playback, the DVD video camera/recorder will enter the playback pause status.

Note:

- In slow playback, a rapidly moving subject image may be distorted.
- The intervals for playing back frames in frame advance/frame back/slow playback are as follows:
Frame advance and forward slow: Approx. 0.03 seconds
Frame back and reverse slow: Approx. 0.5 seconds
- No sound will be heard during search playback or slow playback.

SKIP PLAYBACK OF MOVIE

During playback, press the **⏮** or **⏭** button to locate the start of desired scene.

Press **⏭** once:
To skip to the first image of the scene following the one being played back, and start playback.

Press **⏮** once:
To return to the first image of the scene being played back, and start playback.

Hold down **⏭** :
To continuously locate the beginnings of scenes, starting from the scene following the scene being played back. When the desired image appears, release the button: Playback will start from that point.

Hold down **⏮** :
To continuously locate the beginnings of scenes backward, starting from the scene preceding the scene currently being played back. When the desired image appears, release the button: Playback will start from that point.

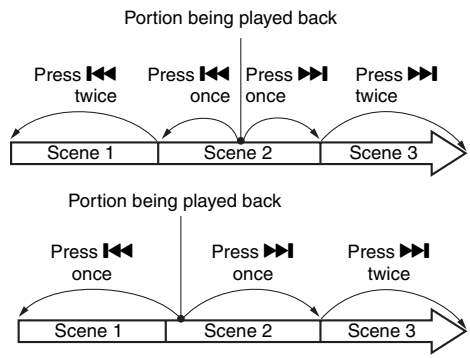

Pressing the **⏮** button at a portion several seconds from the start of scene being played back will return to the start of the scene preceding that being played back.

Note:

- If you perform skip playback during playback pause, the DVD video camera/recorder will enter the playback pause status at the beginning of the located scene.
- Pressing the **⏭** button in the last scene on HDD or disc will set the DVD video camera/recorder to the playback pause status at the last image.
- If the temperature inside the DVD video camera/recorder rises, normal skip or search playback may not be possible: Turn the DVD video camera/recorder off, wait for a few moments, and then turn it on again.

PLAYING BACK STILLS

Press the **⏮** or **⏭** button during playback to quickly play back stills in sequence.

Press **⏭** once:
To display stills one by one forward.

Press **⏮** once:
To display stills one by one backward.

[When using DVD-RAM]

(This DVD video camera/recorder cannot record any photo on a DVD-RAM.)

Releasing the **⏮** or **⏭** button will start continuous playback.

[When using card]

When the **⏮** or **⏭** button is released, the photo at that point will be displayed, and then the DVD video camera/recorder will enter the playback pause status.

Use the slide show function for continuous display (p. 115).

JUMPING TO SPECIFIED POINT (GO TO)

1 Press the MENU button during playback.

2 Choose the option (point you want to go to), and then press the **▶/||** button.

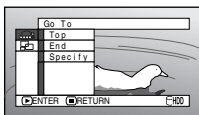

Top:

To go to the start, and enter playback pause.

End:

To go to the end of last scene, and enter playback pause.

Specify:

To go to a specified point and enter playback pause. See the following for details.

● Specifying the point to view

1 Choose "Specify" in step 2 above, and then press the **▶/||** button.

The screen for specifying the point to go to will appear.

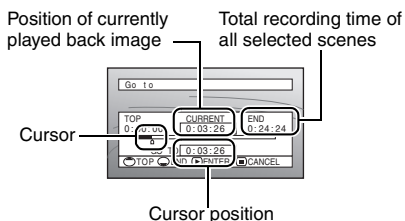

2 Use the **◀◀/▶▶/◀/▶** buttons to select the desired time of chosen point.

Press **◀◀** : To select the start.

Press **▶▶** : To select the end.

Press **◀** or **▶** :

- Press once:

To move the cursor in 1-minute units for HDD
(10-second units for DVD, 1-still units for card)

- Hold down:

To move the cursor in 10-minute units for HDD
(1-minute units for DVD, 10-still units for card)

3 Press the **▶/||** button to enter the selection.

The DVD video camera/recorder will go to the specified point and enter the playback pause status.

Pressing the **▶/||** button again will start playback.

Note:

- To cancel the "Go To" procedure midway, press the **■** button before going to the specified point.
- If multiple scenes are selected using the Disc Navigation function or PHOTO/SELECT button, choosing "Top" will jump to the beginning of selected scenes (p. 109).
- When multiple scenes are selected, the total time of selected scenes will appear in the "total recording time" display.
- With card, the number of stills will appear at the "TOP", "CURRENT", "END" and "GO TO" indicators.
- The cursor may not move at same-pitch intervals.

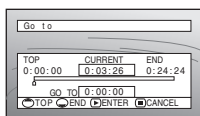

(When the start of scene is selected)

INFORMATION DISPLAY DURING PLAYBACK

Various types of information on recording will be superimposed on playback image you are viewing.

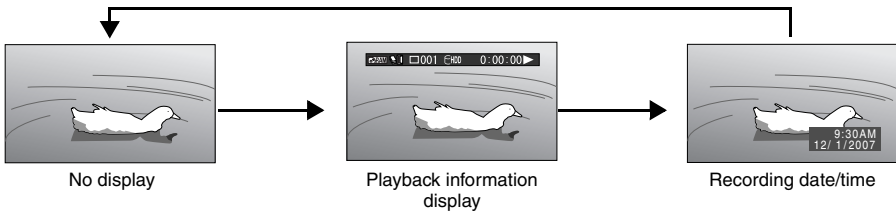

● Switching the information display mode

Press the DISPLAY button: You can switch the display mode of on-screen information.

When using HDD/DVD:

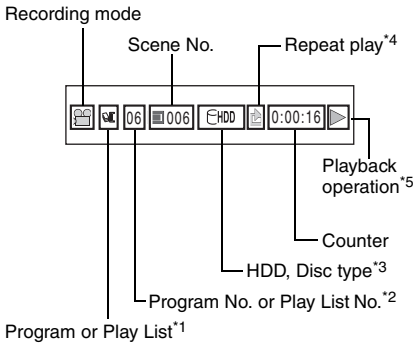

When using card:

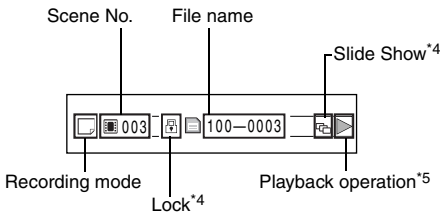

- *1 Program or Play List.
- *2 Number of program or play list being played back (not displayed when all programs are being played back).
- *3 Refer to "HDD, DVD/Card type" on page 48.
- *4 Will appear when each function is specified "On".
- *5
 - : Standard playback
 - : Playback pause
 - : Forward search playback
 - : Reverse search playback
 - : Forward skip playback
 - : Reverse skip playback
 - : Forward frame advance
 - : Reverse frame back
 - : Forward slow playback
 - : Reverse slow playback

See pages 73-76 for how to operate.

The "⏪" mark will appear on the first image on disc.

The "⏩" mark will appear on the last image on disc.

- **Recording date/time display:** Shows the date/time when recording was started. Even when playback starts, the date/time display will not advance.
- **No display:** No information will appear. However, when the mode of playback operation is switched, the symbol will appear for approx. 3 seconds.

Note:

See page 99 and after for "Program", page 102 and after for "Play List".

SELECTING MULTIPLE SCENES

- 1 Press the DISC NAVIGATION button.
- 2 Use the **◀◀/▶▶/◀◀/▶▶** buttons to select the desired scene.
- 3 Press the PHOTO/SELECT button once:

The selected scene will be framed in red and yellow.

Repeat steps 2 and 3 to randomly select multiple scenes.

SELECTING CONSECUTIVE SCENES TOGETHER

- 1 Press the DISC NAVIGATION button.

- 2 Use the **◀◀/▶▶/◀◀/▶▶** buttons to point the cursor at the first scene in the range of scenes you want to select.

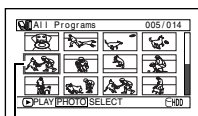

Yellow frame

- 3 Hold down the PHOTO/SELECT button for at least one second:

The selected scene will be doubly framed in yellow and blue.

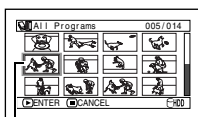

Double frames in yellow and blue

- 4 Use the **◀◀/▶▶/◀◀/▶▶** buttons to select the last scene in the range you want, and then press the **▶/||** button:

The thumbnails of scenes in the specified range will be framed in red, and then selected.

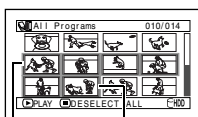

Red frame

When scenes up to this point are selected

Note:

- You can know the status of scenes from the colors of cursor and bargraph:

Cursor	Bar graph	Status of scenes
Yellow	Light blue	Current cursor position
Blue	Light blue	Range of scenes being selected
Red	Yellow	Scenes already selected

- Pressing the **▶/||** button after selecting scenes will play back only the selected scenes from the beginning of each.
- To cancel a selected scene, select the scene to be canceled, and then press the PHOTO/SELECT button.
To cancel all selected scenes, press the **■** button.
- You can also select scenes in reverse from the last scene in the range.
- To release multiple selection, press the **■** or PHOTO/SELECT button before pressing the **▶/||** button in step 4.
- Up to 999 scenes can be selected.

FUNCTIONS AVAILABLE WITH DISC NAVIGATION

The Disc Navigation mode will allow a variety of further operations.

Available function	HDD	RAM	RW/VR	RW/VE	R	+RW	CARD	Contents	Reference page
Editing of scenes	●	●	●				▲*1	You can delete unnecessary scenes, combine scenes, or divide one scene.	89 – 91
Setting special effects to scenes	●	●	●					You can attach fade and skip to a scene, and change existing thumbnails.	92 – 94
Copy from disc to card		●						You can copy photos recorded on DVD-RAM disc to card.	95
Scene lock							●	You can lock any scene so that it will not be deleted by mistake: Essential scenes are thereby protected, and recording another still is possible.	96
Scene information display	●	●	●	●	●	●	●	You can display information on one scene or multiple scenes, such as image quality, recording time, etc.	98
Changing title	●	●	●					You can change the title of play list or program.	100, 108
Creation of play list	●	●	●					You can create an original movie by changing the combination of scenes.	102
Initialization	●	●	●	●		●	●	You can delete all data recorded on HDD/DVD/Card.	109
Protection	●	●	●					You can protect the HDD/DVD-RAM/DVD-RW (VR-mode) to prevent deletion or editing by mistake.	110
Remaining display (Capacity)	●	●	●	●	●	●	●	The remaining recordable movie time or number of recordable stills is displayed.	110
Disc finalization			●*2	●	●	●		You can use this DVD video camera/recorder to finalize any DVD-RW/DVD-R/+RW recorded on it so that the disc can be viewed on DVD recorder/player, etc.	112
Unfinalizing disc				●		●		You can unfinalize a DVD-RW (VF-mode)/+RW that was finalized on this DVD video camera/recorder so that additional videos can be recorded on the disc.	113
Repeat play	●	●	●	●	●	●		You can repeatedly play back programs and scenes.	115
Slide show							●	You can play back stills continuously.	115

*1 Only deletion is possible.

*2 Additional recording can be made on a finalized DVD-RW (VR-mode).

Note:

Adding special effects to scenes are unique functions of this DVD video camera/recorder. When a disc with any effects set on this DVD video camera/recorder is directly played back on a DVD recorder/player or read into PC, the set effect results will not be reflected in the playback or reading. To reflect the set effect results, connect both devices using the AV/S input/output cable and then perform recording (Dubbing, p. 119).

UNDERSTANDING FLOW OF DISC NAVIGATION MENU

Press the MENU button on the Disc Navigation screen: The menu screens for Disc Navigation and menu screens for HDD/DVD/Card will appear.

Shaded items will also appear in Quick Menu display mode (see page 51).

Refer to pages indicated for details of settings.

● When using HDD

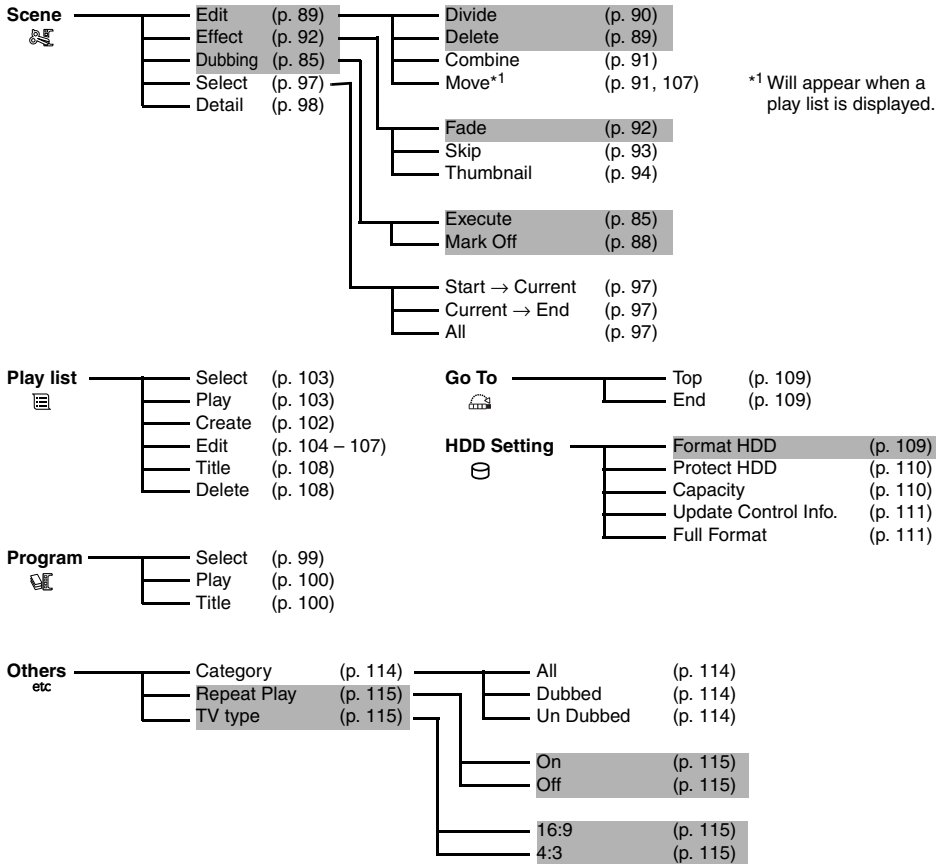

● When using DVD-RAM/DVD-RW (VR-mode)

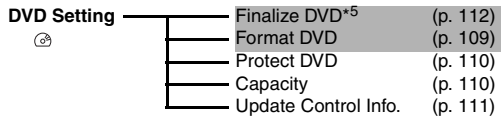
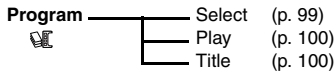
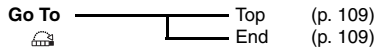
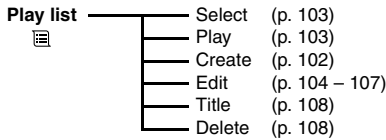
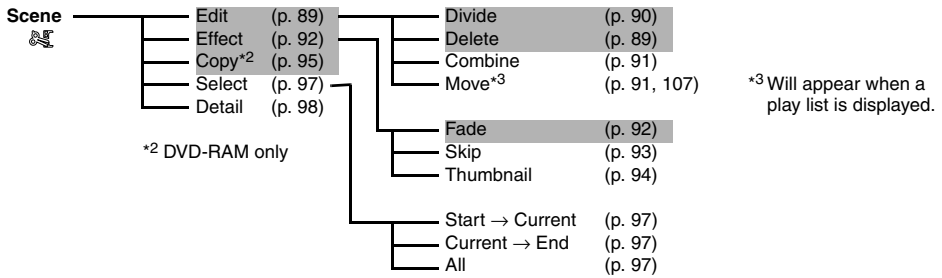

*⁵ DVD-RW (VR-mode) only

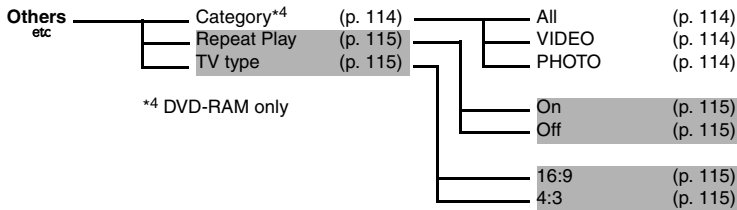

● When using DVD-RW (VF-mode)/DVD-R/+RW

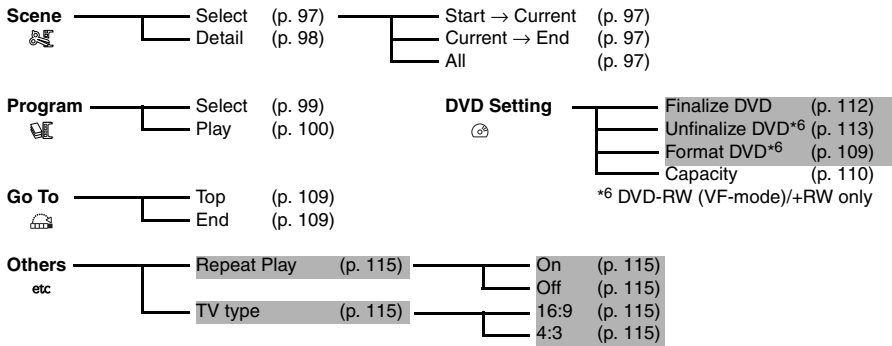

● When using card

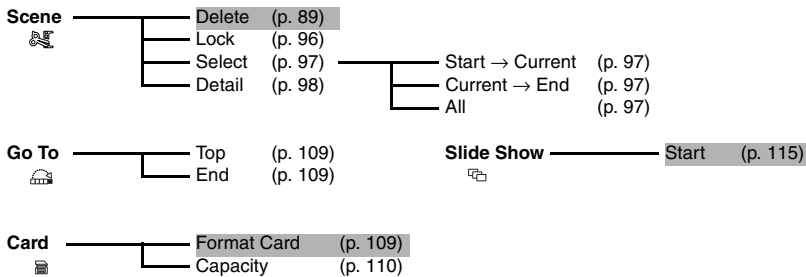

Dubbing on DVD

This DVD video camera/recorder allows you to choose the desired method when dubbing images recorded on HDD to a DVD:

“New”: To dub scenes recorded on HDD to a DVD, without dubbed marks appearing, beginning with the first scene without dubbed mark.

“Date”: To dub scenes recorded on HDD on the same date to a DVD, beginning with the first scene.

“All”: To dub all scenes recorded on HDD to a DVD, beginning with the first scene.

“Select”: To select your favorite scenes from all those recorded on HDD, for dubbing.

Before You Begin

- Set the power switch to “HDD”.
- Prepare a recordable disc.
- The recording time for a scene that can be dubbed on one disc is approx. 30 minutes (in FINE mode). If the HDD contains a scene exceeding the length that is recordable on one disc, it cannot be dubbed: Divide the scene (see p. 90), and then perform dubbing.
- Be sure to use the AC adapter/charger to power the DVD video camera/recorder during dubbing: Dubbing is not possible with a battery connected.
- If power is turned off and dubbing is interrupted midway, proper dubbing will not be possible.
- The time shown on dubbing is for reference: Dubbing will be performed at normal speed in XTRA mode; approx. 2 times the normal in FINE mode; approx. 4 times the normal in STD mode.
If the number of scenes on HDD is too large, or the temperature of this DVD video camera/recorder is too high, the required recording time may be longer than the display time on screen.

● List of dubbing possible/impossible



Disc to be dubbed	Videos on HDD		
	VIDEO Modes (XTRA/FINE/STD) mixed	Wide/normal modes (16:9/4:3) mixed	VIDEO Mode “STD” and wide mode (16:9)
DVD-RAM	●	●	●
DVD-RW (VR-mode)	●	●	●
DVD-RW (VF-mode)	—	—	—
DVD-R	—	—	—
+RW	●*	●*	—

●: Dubbing possible; —: Dubbing impossible

* You cannot specify the combination of “VIDEO Mode: STD” and “16:9 On”.

● Note when dubbing:

- If message “Scene No.xxx is too large. Please divide this Scene before dubbing.” appears during dubbing, the dubbing will stop. Divide the specified scene (see page 90), and then dub the divided scenes.
- The maximum number of scenes and programs that can be dubbed will vary depending on the DVD used (see page 159).
- With this DVD video camera/recorder, the scenes on HDD will be dubbed to a DVD in the order of display on HDD Disc Navigation screen. To dub the scenes in a different order, create a play list on which scenes are registered in the desired order of dubbing (see page 102), and then execute dubbing.

- If you want to dub only the scenes with dubbed marks , "Category" in HDD setting should be designated (see page 114).
- Marks  will appear for the thumbnails of the scenes which have been once dubbed. If the marks make the thumbnails difficult to see, you can turn off the  marks (see page 88).
- If a finalized disc or a heavily scratched or dirty disc is inserted into this DVD video camera/recorder, a message will appear and dubbing will not be possible: Use another disc.
- A DVD-RW/DVD-R dubbed on this DVD video camera/recorder will not be finalized: To play it back on a DVD recorder, be sure to finalize it on this DVD video camera/recorder.
- The details of editing scenes on HDD (fade, skip, change of thumbnail, etc.) will not be reflected in the scenes if they are dubbed on a DVD-RW (VF-mode)/DVD-R/+RW.
- If you combine scenes with different recording dates on a play list, and dub the combined scene to a DVD-RAM/DVD-RW (VR-mode), the scenes will be dubbed separately for each date. However, if a combined scene is subsequently divided, the scenes may not be dubbed separately for each date.
- If you dub scenes combined using the Disc Navigation function to a DVD-RW (VF-mode)/DVD-R/+RW, the two scenes immediately before the combination (sometimes more than two scenes) will be dubbed.
- If you divide a scene using the Disc Navigation function, and then dub both the divided scenes to a DVD-RW (VF-mode)/DVD-R/+RW, the scene before the division will be dubbed.
- **Please note in advance that Hitachi will not accept any responsibility for compensation or loss of data, or direct or indirect damage when dubbing is not performed normally due to a fault in this DVD video camera/recorder.**

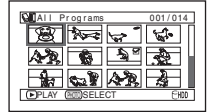



FIRST-TIME ("NEW") DUBBING

This option allows you to dub scenes without dubbed marks, among those recorded on HDD, to a DVD beginning with the first scene without dubbed mark.

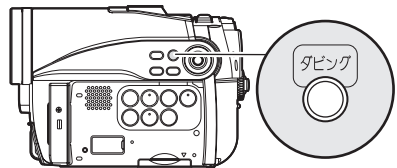

If those scenes cannot be included on one DVD, the capacity of scenes will be calculated and the scenes will be dubbed up to capacity. When the DVD is replaced following the instruction on replacement of DVD during dubbing, dubbing will start from the scene following: Repeat this operation until dubbing of all scenes on HDD without dubbed marks is finished.

- 1 Press the DUBBING button.
The Dubbing Menu will appear.
You can also display the Dubbing Menu from the Disc Navigation screen: Press the DISC NAVIGATION button, press the MENU button, choose "Scene", "Dubbing", "Execute", and then press the  button.

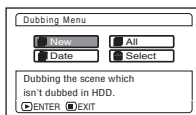

- 2 From the Dubbing Menu screen, choose "New" and press the  button.
If no DVD is loaded in this DVD video camera/recorder, a message will appear: Press the DISC EJECT button, and then load a DVD.



Pressing the  button at this time will allow you to check the scenes to be dubbed to a DVD that is loaded in the DVD video camera/recorder: The scenes to be dubbed will be encircled by a red cursor. To return to the verification screen, press the  (stop/cancel) button.

To stop dubbing, choose "NO" on the verification screen, or press the  (stop/cancel) button.

- 3 The screen for verification will appear:
Choose "YES" and press the  button.

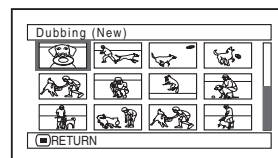
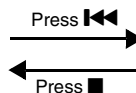
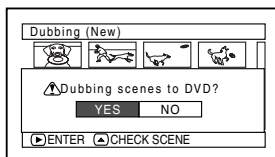

- 4** Replace the DVD.
If one disc cannot contain all scenes, the screen for verifying DVD replacement will appear. To continue dubbing, press the DISC EJECT button, and then replace the DVD: Dubbing will restart from the scene following.
To stop dubbing, press the ■ (stop/cancel) button.

- 5** After dubbing is finished, check the “Delete Scene” screen.
Choosing “YES” will delete the dubbed scenes from the HDD.
To retain the dubbed scenes on the HDD, choose “NO”.

- 6** Press DISC EJECT button to remove the DVD. Close the cover of DVD insertion block.
If you do not want to remove the DVD, press the ■ (stop/cancel) button to end dubbing.

DUBBING SCENES RECODED ON SAME DAY COLLECTIVELY (“DATE” DUBBING)

This option allows you to collectively dub scenes recorded on HDD on one day, to a DVD. If those scenes cannot be included on one DVD, the capacity of scenes will be calculated and the scenes will be dubbed up to capacity. When the DVD is replaced following the instruction on replacement of DVD during dubbing, dubbing will start from the scene following: Repeat this operation until dubbing of all scenes recorded on HDD on one day is finished.

- 1** Press the DUBBING button.
The Dubbing Menu will appear.
You can also display the Dubbing Menu from the Disc Navigation screen: Press the DISC NAVIGATION button, press the MENU button, choose “Scene”, “Dubbing”, “Execute”, and then press the ►/|| button.
- 2** From the Dubbing Menu screen, choose “Date” and press the ►/|| button.
If no DVD is loaded in this DVD video camera/recorder, a message will appear: Press the DISC EJECT button, and then load a DVD.

- 3** From the “Select Date” screen, select the date on which scenes are to be dubbed, and then press the ►/|| button.
If you have changed the title of program (see page 100), the title will appear on the “Select Date” screen in place of the date.

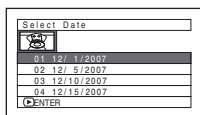

- 4** The screen for verification will appear: Choose “YES” and press the ►/|| button.
Pressing the ◀◀ button at this time will allow you to check the scenes to be dubbed to a DVD that is loaded in the DVD video camera/recorder: The scenes to be dubbed will be encircled by a red cursor. To return to the verification screen, press the ■ (stop/cancel) button.

- 5** Replace the DVD.
If one disc cannot contain all scenes, the screen for verifying DVD replacement will appear. To continue dubbing, press the DISC EJECT button, and then replace the DVD: Dubbing will restart from the scene following.
To stop dubbing, press the ■ (stop/cancel) button.

- 6** After dubbing is finished, check the “Delete Scene” screen.
Choosing “YES” will delete the dubbed scenes from the HDD.
To retain the dubbed scenes on the HDD, choose “NO”.

- 7** Press DISC EJECT button to remove the DVD. Close the cover of DVD insertion block.
If you do not want to remove the DVD, press the ■ (stop/cancel) button to end dubbing.

DUBBING ALL SCENES RECORDED ON HDD (DUBBING “ALL”)

You can dub all scenes recorded on the HDD to a DVD from the beginning in sequence.

If the scenes cannot be included on one DVD, count the capacity size of scenes, and dub the scenes that can be stored on the DVD. Replace the disc during dubbing, following the screen for replacing DVD: Dubbing will restart from the following scene. This operation will be repeated until all scenes on the HDD are dubbed.

- 1** Press the DUBBING button.
The Dubbing Menu will appear.
You can also display the Dubbing Menu from the Disc Navigation screen: Press the DISC NAVIGATION button, press the MENU button, choose “Scene”, “Dubbing”, “Execute”, and then press the ►/|| button.
- 2** From the Dubbing Menu screen, choose “All” and press the ►/|| button.
If no DVD is loaded in this DVD video camera/recorder, a message will appear: Press the DISC EJECT button, and then load a DVD.
- 3** The screen for verification will appear: Choose “YES” and press the ►/|| button.
Pressing the ◀◀ button at this time will allow you to check the scenes to be dubbed to a DVD that is loaded in the DVD video camera/recorder. The scenes to be dubbed will be encircled by a red cursor. To return to the verification screen, press the ■ (stop/cancel) button.
- 4** Replace the DVD.
If one DVD cannot contain all scenes, the screen for verifying disc replacement will appear. To continue dubbing, press the DISC EJECT button, and then replace the DVD. Dubbing will restart from the scene following. To stop dubbing, press ■ (stop/cancel).
- 5** After dubbing is finished, check the “Delete Scene” screen.
Choosing “YES” will delete the dubbed scenes from the HDD.
To retain the dubbed scenes on the HDD, choose “NO”.
- 6** Press the DISC EJECT button to remove the DVD.
Close the cover of DVD insertion block.
If you do not want to remove the DVD, press the ■ (stop/cancel) button to end dubbing.

SELECTING SCENES RECORDED ON HDD AND DUBBING THEM (SCENE "SELECT" DUBBING)

You can select desired scenes recorded on HDD and dub only those scenes on DVDs.

- 1 Press the DUBBING button.
The Dubbing Menu will appear.
You can also display the Dubbing Menu from the Disc Navigation screen: Press the DISC NAVIGATION button, press the MENU button, choose "Scene", "Dubbing", "Execute", and then press the ►/|| button.
- 2 From the Dubbing Menu screen, choose "Select" and press the ►/|| button.
If no DVD is loaded in this DVD video camera/recorder, a message will appear: Press the DISC EJECT button, and then load a DVD.
- 3 Place the cursor on a scene to be dubbed, and then press the ►/|| or PHOTO/SELECT button: The cursor of the selected scene will change to red (see p. 79), and the scene with red cursor will be dubbed to a DVD.

If you wish to dub other scenes, place the cursor on a scene in the same way, and press the ►/|| or PHOTO/SELECT button to select it.

To cancel a selected scene, press the ►/|| or PHOTO/SELECT button again. To cancel all selected scenes, press ■ (stop/cancel).

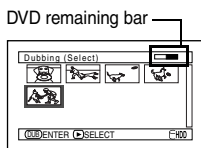

If the total capacity size of the selected scenes exceeds the remaining free space on DVD, the remaining bar at the top right of screen will be red, and a message will appear. Select the scenes again.

If you select a scene whose size exceeds one DVD, a message that prompts you to divide it will appear: After dividing the scene, execute dubbing again.

- 4 Press the DUBBING button.
The screen for verifying dubbing will appear. Instead of pressing the DUBBING button, you can press the MENU button, choose "Edit", and then "Enter": The same screen will appear.

Choosing "YES" will start dubbing.
To cancel dubbing, choose "NO" or press ■ (stop/cancel).

- 5 When dubbing is finished, check the "Delete Scene" screen.
Choosing "YES" will delete the dubbed scenes from the HDD.
To retain the dubbed scenes on the HDD, choose "NO".

- 6 Press the DISC EJECT button to remove the DVD.
Close the cover of DVD insertion block.
If you do not want to remove the DVD, press the ■ (stop/cancel) button to end dubbing.

TURNING OFF DUBBED MARK FROM THUMBNAIL (MARK OFF)

If the dubbed mark makes the thumbnail difficult to see, you can turn off the mark.

- 1 Press the DISC NAVIGATION button, and then press the MENU button.
- 2 Choose "Scene", "Dubbing", "Mark Off", and then press the ►/|| button.
The "Cancel Dubbed Mark" screen will appear.

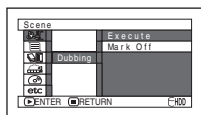

- 3 Place the cursor on a scene for which you want to turn the dubbed mark off, and then press the PHOTO/SELECT button.
You can also select multiple scenes.

- 4 If there is no change in the scene for which you want to turn the mark off, press the ►/|| button.

- 5 Press the ■ (stop/cancel) button to end the mark-off procedure.

Note:

- You can use "New" dubbing to dub scenes with the dubbed mark turned off.
- Pressing the MENU button in step 3 will display the submenu screen (see "Editing using submenu" on page 90).

DELETING SCENES (EDIT – DELETE)

You may want to delete unwanted scenes.

Scenes on DVD-RW (VF-mode)/DVD-R cannot be deleted, and menu item “Delete” will not appear with DVD-RW (VF-mode)/DVD-R.

When using +RW, no scene can be deleted from the Disc Navigation menu, but the scenes recorded last on it can be deleted (see page 74).

1 Press the DISC NAVIGATION button.

2 Place the cursor on the scene to be deleted.

3 Press the MENU button.

4 Choose “Scene”, “Edit”, “Delete”, and then press the ►/|| button.
When using card, choose “Scene”, “Delete”, and then press the ►/|| button.

5 The “Delete Scene” screen will appear: If you are sure you want to delete the selected scene, press the ►/|| button.

If you want to change the scene to be deleted, you can change it on this screen.

6 The screen for verifying deletion will appear: Choose “YES”, and then press the ►/|| button.

Choose “NO” to cancel deletion.

After Yes or No setting, the “Delete Scene” screen will be restored.

Repeat steps 5 and 6 to delete other scenes.

7 Press the ■ button to quit.

Note:

- If you point the cursor at the scene to be deleted on DISC NAVIGATION screen, and then press the DELETE button on remote control, the screen in step 5 will appear.
- To delete an unwanted part of a scene on DVD-RAM/DVD-RW (VR-mode), divide the scene first, and then delete the unnecessary part (see page 90).
- If you delete all data on HDD/DVD/card, initializing the HDD/DVD/card will be recommended (see page 109).
- If the time of deleted scenes (stills) is quite short, the remaining free space of HDD/DVD/card may not increase in the HDD/DVD/card or card remaining indicator.
- The locked scenes on card cannot be deleted (see page 96).

● Editing using submenu

Press the MENU button before pressing the ►/|| button in step 5 (see page 89): The submenu will appear.

- Edit ——— Delete*1To delete selected scenes
- Exit.....To restore the Disc Navigation screen
- Select ——— Start → Current.....To select scenes from the start to the one that the cursor is on at the moment
- Current → End.....To select scenes from the scene the cursor is on to the end
- AllTo select all scenes
- Go To ——— TopTo move the cursor to the first scene
- End.....To move the cursor to the last scene

Pressing the ■ button will restore the screen in step 5.

*1 The menu item to be displayed will vary depending on the setting.

Note:

Although the submenu screen will appear for each setting, some menu items may not appear, depending on the setting.

HDD RAM RW VR

DIVIDING MOVIES (EDIT – DIVIDE)

You can divide a scene into two parts.

To delete unnecessary portion of scene, first divide the scene, and then delete the unnecessary portion.

- 1 Press the DISC NAVIGATION button.
- 2 Place the cursor on the scene to be divided.
- 3 Press the MENU button.
- 4 Choose, “Scene”, “Edit”, “Divide” and then press the ►/|| button.
- 5 The “Divide Scene” screen will appear: If you are sure you want to divide the selected scene, press the ►/|| button: The selected scene will be played back.

If you want to change the scene to be divided, you can change it on this screen.

- 6 When you reach the point where you want to divide the scene, press the PHOTO/SELECT button.

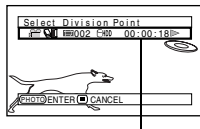

The status bar of scene being played back can be switched off or on by pressing the DISPLAY button

- 7 The screen for verifying division will appear: Choose “YES”, and then press the ►/|| button.

Choose “NO” to cancel division.

After division, the “Divide Scene” screen will be restored.

Repeat steps 5 – 7 to divide another scene.

- 8 Press the ■ button to quit.

Note:

- If you press the MENU button before pressing the ►/|| button in step 5, the submenu will appear.
- Search and frame advance are useful when designating division points.
- Combining scenes that were divided will restore the original scene (see page 91).
- If a special effect has been added to the original scene, the “IN” effect will be added to the first half of scene, and the “OUT” effect, to the latter half.
- The division point may drift before or after the designated point by approximately 0.5 seconds.
- Since a scene with a skip set cannot be played back, no division point can be specified: Release the skip for the scene before dividing it.
- If the division point is at a still, a message will appear, but no division will be made.
- If the division point is at the start or end of a scene, a message will appear, but no division will be made.
- A movie scene whose recording time is 0.5 seconds or less cannot be divided.
- If free space available on HDD/DVD is insufficient, division will not be possible: Delete unnecessary scenes.
- If you divide a scene with dubbed mark , the dubbed marks will appear on both divided scenes.

COMBINING MULTIPLE SCENES (EDIT – COMBINE)

If you have recorded numerous short scenes, combining them will be facilitated by the use of Disc Navigation.

Be sure to select consecutive multiple scenes: When using the HDD or a DVD-RAM, combining scenes is possible only when “Category: All” is specified (p. 114). Stills cannot be combined.

1 Press the DISC NAVIGATION button.

2 Press the MENU button, choose “Scene”, “Edit”, “Combine”, and then press ►/|| button.

3 The “Combine Scenes” screen will appear: Point the cursor at the first scene to be combined, and then press the ►/|| button. The cursor will change to double frames of blue and yellow.

4 Use the ◀◀/▶▶/◀◀/▶▶ buttons to determine the range of scenes to be combined, point the cursor at the last scene, and then press the ►/|| button. The cursor will change to a red frame. The last scene will be double frames of red and yellow.

5 If you do not wish to change the scenes to be combined, press the ►/|| button. To change the scenes, press the ■ (stop/cancel) button to return the cursor to yellow, and then select the scenes to be combined again.

6 The screen for verifying combination will appear: Choose “YES”, and then press the ►/|| button.

The two images appearing on the verification screen are those of the first and last scenes to be combined.

Choose “NO” to cancel combination.

After Yes or No setting, the “Combine Scenes” screen will be restored.

The thumbnail of the first scene will appear in the combined scene.

Repeat steps 3 and 6 to combine other scenes.

7 Press the ■ button to quit.

Note:

- You can also select multiple scenes after step 1: Press the MENU button to continue the procedure of combination.
- If you press the MENU button before pressing the ►/|| button in step 3, the submenu will appear (see page 90).
- With fade effect, the “IN” effect of the first scene in the selected range and the “OUT” effect on the last scene will be attached to a combined scene.
- Scenes in different programs (different recording dates) cannot be combined: Create a play list first, and then combine such scenes on the play list.
- When using the HDD, scenes with different VIDEO Modes or 16:9 mode cannot be combined.
- If you combine scenes with dubbed marks , the dubbed marks will appear on the combined scene.
- If you combine scenes with and without dubbed mark , the dubbed mark will not appear on the combined scene.

ARRANGING ORDER OF SCENES (EDIT – MOVE)

You can arrange scenes within a play list by moving them to desired positions (p. 107). Create a play list first, and then arrange the scenes [“CREATING NEW PLAY LIST (CREATE)”, p. 102].

DIRECTING SCENES EFFECTIVELY (EFFECT – FADE)

You can add fading to the beginning and/or end of scene.
There are three types of special effects:

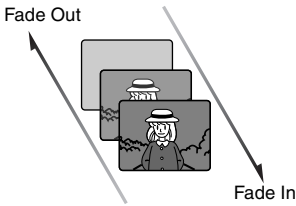

White:

Fades in from white screen
Fades out to white screen

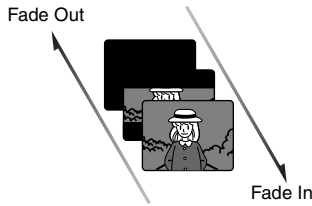

Wipe:

Fades in from black screen
to vertical direction of screen
Fades out from vertical
direction of screen to black
screen

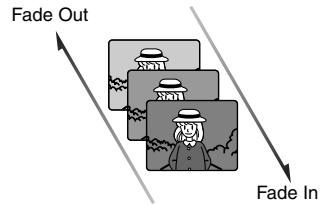

B/W:

Fades in from Black and
White screen to color screen
Fades out from color screen
to Black and White screen

- 1 Press the DISC NAVIGATION button.
- 2 Place the cursor on the scene to which fade is to be added.
- 3 Press the MENU button.
- 4 Choose, "Scene", "Effect", "Fade" and then press the ►/|| button.
- 5 The "Fade" screen will appear: If you are sure you want to add the fade effect to the scene, press the ►/|| button.

If you want to change the scene to which fade is added, you can change it on this screen.
- 6 Select the special effects for "IN" and/or "OUT", choose "Enter", and then press the ►/|| button.

You can use the ◀◀/▶▶ buttons to move the cursor to "IN", "OUT", "Enter" or "Cancel".
Use the ◀◀/▶▶ buttons to choose the effect to be added, and then press the ►/|| button to set the effect.

To cancel setting, choose "Cancel".

If you choose "Enter" and press the ►/|| button, the "Fade" screen will be restored after a message appears.

Repeat steps 5 and 6 to add fade to other scenes.

- 7 Press the ■ button to quit.

The "▲" and/or "▼" icon(s) will appear in the scenes for which fade in and/or fade out have been set.

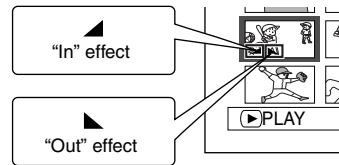

Note:

- If a disc on which fade has been set on scene with this DVD video camera/recorder is played on a DVD reorder/player, or the scene is captured into a PC, the set fade will not be reflected (see Note on page 80).
- When dubbing on a DVD-RW (VF-mode)/DVD-R/+RW, the setting on fade will not be reflected (see page 84).

PLAYING BACK BY SKIPPING SCENES (EFFECT – SKIP)

You can specify “Skip” for scenes you do not want to play back: The selected scenes will be skipped.

- 1 Press the DISC NAVIGATION button.
- 2 Place the cursor on the scene to which skip is to be set.
Multiple scenes can be selected for skipping (p. 79).
- 3 Press the MENU button.
- 4 Choose “Scene”, “Effect”, “Skip”, and then press the ►/|| button.
- 5 The “Set Skip” screen will appear: If you are sure you want to skip the selected scene, press the ►/|| button.

If you want to change the scene to be skipped, you can change it on this screen. After skip setting, the “Set Skip” screen will be restored.
Repeat step 5 to set skipping of other scenes.

- 6 Press the ■ button to quit.

A skip icon “≡” will appear in the thumbnail of any scene for which skipping has been set.

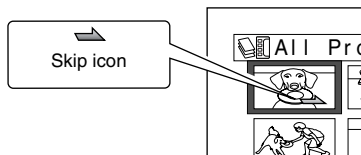

● Releasing Skip

Perform the same procedure as setting skip: The skip icon will disappear and skipping of the scene will be released.

Note:

- If you press the MENU button before pressing the ►/|| button in step 5, the submenu screen will appear (p. 90).
- If a disc on which skip has been set on scene with this DVD video camera/recorder is played on a DVD reorder/player, or the scene is captured into a PC, the set skip will not be reflected (see Note on page 80).
- When dubbing on a DVD-RW (VF-mode)/DVD-R/+RW, the setting on skip will not be reflected (see p. 84).

CHANGING IMAGES FOR THUMBNAILS (EFFECT – THUMBNAIL)

Normally, the first image of the recorded scene is displayed as a thumbnail: You can choose another image of the scene for thumbnail. If you set a vivid image to thumbnail, you can know what you recorded from a glance at the Disc Navigation screen.

1 Press the DISC NAVIGATION button.

2 Place the cursor on the scene whose thumbnail you wish to change.

3 Press the MENU button.

4 Choose “Scene”, “Effect”, “Thumbnail”, and then press the ►/|| button.

5 The “Change Thumbnail” screen will appear: If you are sure you want to change the thumbnail of the selected scene, press the ►/|| button: The selected scene will be played back.

If you want to change the scene whose thumbnail is to be changed, you can change it on this screen.

6 When the image you want to use as the thumbnail of the scene appears, press the PHOTO/SELECT button.

7 The screen for verifying switching of thumbnail will appear: Choose “YES”, and then press the ►/|| button.

Choose “NO” to cancel switching of thumbnail.

After Yes or No setting, the “Change Thumbnail” screen will be restored.

Repeat steps 5 – 7 to change the other scenes.

8 Press the ■ button to quit.

Note:

- If you press the MENU button before pressing the ►/|| button in step 6, the submenu screen will appear (p. 90).
- A thumbnail of still cannot be changed.
- Since the scene to which skipping is set cannot be played back, you will not be able to change its thumbnail: Release the skip setting of the scene to change the thumbnail.
- If a disc on which thumbnail has been set with this DVD video camera/recorder is played on a DVD reorder/player, or the scene is captured into a PC, the set thumbnail will not be reflected (see Note on page 80).
- When dubbing on a DVD-RW (VF-mode)/DVD-R/+RW, the setting on changing thumbnail will not be reflected (see page 84).

COPYING STILLS ON DVD-RAM TO CARD (COPY)

Before You Begin

- Set the DVD-RAM (recorded on a Hitachi DVD video camera/recorder that can record photos on a DVD-RAM) that includes the photos you wish to copy, and a card with recordable space, in this DVD video camera/recorder.

- 1** Set the power switch to “DVD”.
- 2** Press the DISC NAVIGATION button.
- 3** Place the cursor on the scene to be copied.
- 4** Press the MENU button.
- 5** Choose “Copy” on the “Scene” menu screen, and then press the ►/|| button.
- 6** The “Copy to card” screen will appear: If you are sure you want to copy the selected still, press the ►/|| button.

If you want to change the still to be copied, you can change it on this screen.

- 7** The screen for verifying copy will appear: Choose “YES”, and then press the ►/|| button.

Choose “NO” to cancel copy.
After Yes or No setting, the “Copy to card” screen will be restored.
Repeat steps 6 and 7 to copy other stills to card.

- 8** Press the ■ button to quit.

Note:

- No movie can be copied.
- If you press the MENU button before pressing the ►/|| button in step 6, the submenu screen will appear (p. 90).
- See “Category” (p. 114) to check the stills recorded on DVD-RAM.
- You can also select multiple scenes (p. 79).
- Even if all scenes, including movies, are selected to be copied, only stills will be copied.
- Data on card cannot be copied to DVD.

LOCKING SCENES ON CARD (LOCK)

You can lock each photo recorded on card so that it will not be deleted or edited by mistake.

- 1 Set the power switch to "SD".
- 2 Press the DISC NAVIGATION button.
- 3 Place the cursor on the scene to be locked.
You can also select multiple scenes (p. 79).
- 4 Press the MENU button.
- 5 Choose "Lock" on the "Scene" menu screen, and then press the ►/|| button.
- 6 The "Lock Set" screen will appear: If you are sure you want to lock the selected scene, press the ►/|| button.



If you want to change the scene to be locked, you can change it on this screen.

After setting, the "Lock Set" screen will be restored.

Repeat step 6 to lock another scene.

- 7 Press the ■ button to quit.

The lock icon "🔒" will appear on any scene for which lock has been set.

● To unlock the scene

Select the locked scene, and then use the procedure shown on the left to unlock the scene: The lock icon will disappear and locking will be released.

Note:

- If you press the MENU button before pressing the ►/|| button in step 6, the submenu screen will appear (p. 90).
- When initializing the card, the locked scenes will also be deleted.

SELECTING SCENES USING MENU SCREEN (SELECT)

You can use this "Select" function to select consecutive scenes at one time. This function is useful when there are numerous scenes.

1 Press the DISC NAVIGATION button.

2 Point the cursor at the first or last scene to be selected: When selecting all scenes, simply proceed with step 3.

3 Press the MENU button.

4 Choose "Select" on the "Scene" menu screen.

5 Choose "Start → Current", "Current → End" or "All" and then press the ►/|| button.

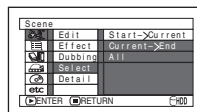

● Deselecting selected scenes

Deselecting scenes one by one:

While you are displaying the "All Programs" screen on which scenes have been selected, place the cursor on the scene to be deleted, and then press the PHOTO/SELECT button.

Note:

Up to 999 scenes can be selected.

Deselecting all the selected scenes at once:

While you are displaying the "All Programs" screen on which scenes have been selected, press the ■ button.

DISPLAYING INFORMATION USING MENU SCREEN (DETAIL)

You can display various information for a scene: the recording mode, recording date/time and length, special effects and movie quality mode.

- 1 Press the DISC NAVIGATION button.
- 2 Place the cursor on the scene whose information you wish to know.
- 3 Press the MENU button.
- 4 Choose "Scene", "Detail", and then press the ►/|| button.

The detailed information on the scene will appear.

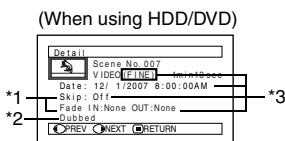

(When using HDD/DVD)

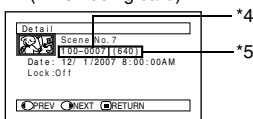

(When using card)

- *1 Not displayed with DVD-RW (VF-mode)/DVD-R/+RW.
- *2 When using the HDD, any scene whose thumbnail has the dubbed mark will appear.
- *3 Not displayed with DVD-RAM/DVD-RW/DVD-R (finalized)/+RW recorded on another device.
- *4 Will not appear if the loaded card does not comply with DCF.
- *5 Number of pixels on still in horizontal direction: This may not appear with a JPEG file that does not conform to this DVD video camera/recorder.

Note:

- DCF (Design rule for Camera File system) is a unified image file format for video cameras: Image files can be commonly used for all digital devices that conform to DCF. This DVD video camera/recorder complies with DCF.
- Pressing the ►► button will display information on the following scene; pressing the ◀◀ button will display information on the preceding scene.

- 5 Press the ■ button to quit.

Note:

- If multiple scenes have been selected, the total recording time of the selected scenes (total number in case of stills) will appear.

(When using HDD/DVD)

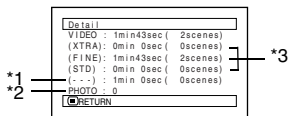

- *1 Number of scenes whose quality mode is unknown: This will appear when the disc has a scene recorded on a device other than this DVD video camera/recorder, only if the disc has a scene whose mode is unknown.
- *2 This will appear with a DVD-RAM, including photos recorded on a Hitachi DVD video camera/recorder that has this capability.
- *3 Not displayed with a DVD-RAM/DVD-RW/DVD-R (finalized) /+RW that was recorded on another device.

(When using card)

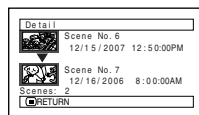

Program

WHAT IS “PROGRAM”?

Program refers to an assembly of scenes recorded on the same date regardless of whether they are movie or still.

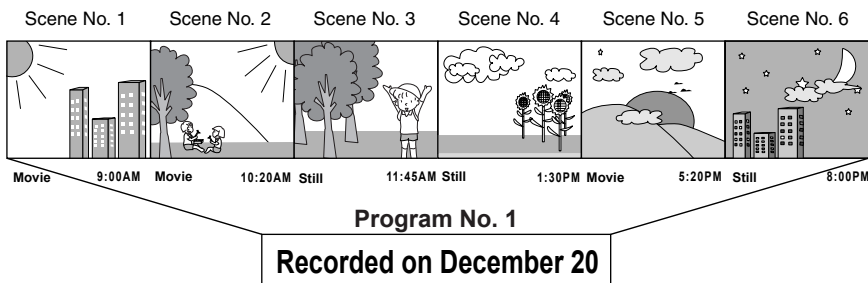

HDD RAM RW VR RW VF R +RW

SWITCHING TO THUMBNAIL DISPLAY OF SPECIFIC DATE (SELECT)

Since the scenes recorded on this DVD video camera/recorder are collected as “programs” for each recording date, selecting a program will allow you to display only the scenes on a specific date.

- 1 Press the DISC NAVIGATION button.
- 2 Press the MENU button.
- 3 Use the **◀◀/▶▶/◀◀/▶▶/▶/||** buttons to choose “Select” on the “Program” menu screen, and then press the **▶/||** button.
- 4 Select the program to be displayed, and then press the **▶/||** button.

The Disc Navigation screen of the selected program will appear.

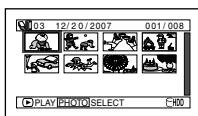
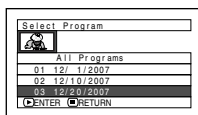

Note:

- Pressing the **■** button on the “Select Program” screen will restore the Disc Navigation screen.
- If a disc recorded on another device is loaded in this DVD video camera/recorder, the program may not be a collection of recordings on the same date.
- If you change the video quality or switch the wide mode with a +RW, multiple programs will be produced even if they are recorded on the same date.

PLAYING BACK PROGRAM (PLAY)

You can play back only the selected program.

- 1 Press the DISC NAVIGATION button.
- 2 Press the MENU button.
- 3 Use the **◀◀/▶▶/◀/▶/▶▶/▶▶** buttons to choose "Play" on the "Program" menu screen, and then press the **▶▶/||** button.

- 4 Select the program to be played back, and then press the **▶▶/||** button.

Playback will start from the first scene of the selected program.

Note:

If "Repeat Play: On" is specified, the selected program will be repeatedly played back (PLAYING BACK SCENES REPEATEDLY (REPEAT PLAY), p. 115).

CHANGING TITLE OF PROGRAM (TITLE)

The recording date/time has initially been attached to any program. You can change the recording date/time to any desired title.

- 1 Press the DISC NAVIGATION button.
- 2 Press the MENU button.
- 3 Choose "Title" on the "Program" menu screen, and then press the **▶▶/||** button.
- 4 Select the program whose title you want to change, and then press the **▶▶/||** button.

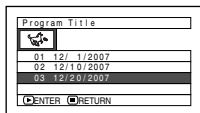

The screen for setting a title will appear.

- 5 Use the **◀◀/▶▶/◀/▶** buttons to select a letter, and then press the **▶▶/||** button: The selected letter will be entered.

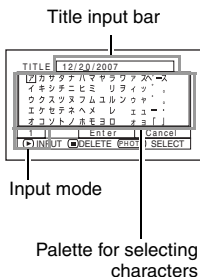

Repeat this procedure, inputting letters one by one to create a title. Up to 20 characters can be input.

- 6 After entering the title, choose "Enter" and then press the **▶▶/||** button.



- 7 The screen for verifying the change in title will appear: Choose "YES", and then press the **▶▶/||** button.



Choose "NO" to cancel changing of the title. After Yes or No setting, the Disc Navigation screen of the selected program will appear.

Note:

- If you wish to delete the letter for title, press the **■** button once: The input letter will be deleted. Holding down the **■** button will delete all letters in the TITLE column.
- You can also use the DELETE button on remote control to delete any input letters.
- Pressing the PHOTO/SELECT button on the title setting screen (in step 5) will change the cursor position from the title input bar to character select palette, input mode number, and then to “Cancel”. You can also use the **◀◀/▶▶/◀/▶** buttons to move the cursor up/down and to the left/right and change its position.
- To cancel the setting of title, choose “NO” on the screen for verifying the entered title: The screen for verifying cancellation of title setting will appear. To cancel title setting, choose “YES”.
- If you press the **■** button on the screen for verifying change in title, the title setting screen will be restored.
- Double byte characters set on other devices may be displayed blank on this DVD video camera/recorder.
- Titles set on this DVD video camera/recorder may not be visible on other devices.

●Characters available for entering title

You can choose the title input mode.

To change the input mode in step 5, press the DISPLAY button, or use the PHOTO/SELECT button to place the cursor on the input mode, and then press the **▶/||** button.

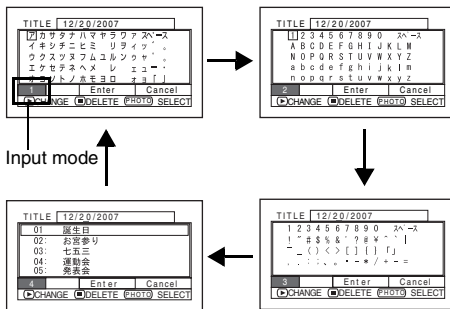

Play List

WHAT IS “PLAY LIST”?

You can create a play list on this DVD video camera/recorder by gathering your favorites from the recorded scenes.

Since the play list is not created by copying data, you will consume little of the HDD/DVD capacity by making a play list. On the other hand, deleting scenes on play list will not increase the remaining HDD/DVD capacity for recording.

Example:

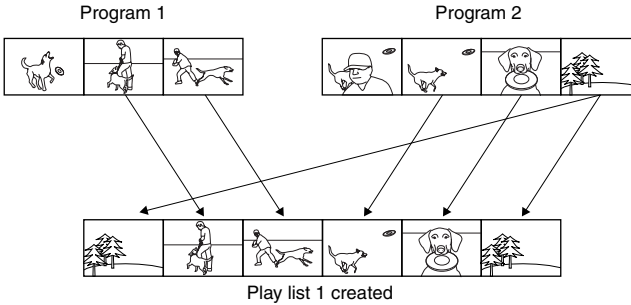

Play list of up to No. 99 can be created, and up to 999 scenes can be included in each play list of No. 1 to No. 99.

CREATING NEW PLAY LIST (CREATE)

- 1 Press the DISC NAVIGATION button.
- 2 Select the scenes to be programmed in a play list.
You can select multiple scenes(p. 79).
- 3 Press the MENU button.
- 4 Use the **⏮/⏭/⏪/⏩/▶/⏸** buttons to choose “Create” on the “PlayList” menu screen, and then press the **▶/⏸** button.
- 5 The “Create PlayList” screen will appear: If the selected scenes on the play list are the ones you want, press the **▶/⏸** button.

If you want to change any of scenes you are registering, you can also use this screen (see pages 79 and 97).

- 6 When creation of a play list is complete, the created play list will appear on the Disc Navigation screen.

Note:

- Only the data on scenes is recorded on play list: If you create or delete play lists, the original scenes in programs will not be erased. Editing scenes on play list will not affect the scenes in programs.
- If the scene in a program had skip or fade setting, or dubbed mark , that information will also be added to the play list.
- You can add other scenes or remove unnecessary scenes to/from the create play list (see pages 104–106).
- The date/time when a play list was created will appear as the title for the play list. This title can later be changed (p. 108).
- If you press the MENU button before pressing the **▶/⏸** button in step 5, the submenu will appear (p. 90).
- If free space available on HDD/disc is insufficient, creation of new play list may not be possible: Delete unnecessary scenes.

SWITCHING TO DISPLAY OF EACH PLAY LIST (SELECT)

Select the desired one of multiple play lists: The Disc Navigation screen of the selected play list will appear.

- 1 Press the DISC NAVIGATION button.
- 2 Press the MENU button.
- 3 Use the **◀◀/▶▶/◀◀/▶▶/▶/||** buttons to choose "Select" on the "PlayList" menu screen, and then press the **▶/||** button.

- 4 Use the "Select Playlist" screen to select the play list you wish to display, and then press the **▶/||** button.

The Disc Navigation screen of the selected play list will be displayed.

Note:

To display the Disc Navigation screen showing all programs (all recorded scenes), choose "All Programs" on the "Select PlayList" screen.

●Editing on play list

When making settings on play list, such as changing title, setting skip, adding fade, etc., use the same procedure for setting on program or scenes. Perform these settings, referring to the following reference pages:

Dubbing,	p. 84
Deleting scene,	p. 89
Changing thumbnail,	p. 94
Setting skip,	p. 93
Adding fade,	p. 92
Combining scenes,	p. 91
Dividing a scene,	p. 90
Copying to card,	p. 95
Changing title,	p. 100, 108
Arranging order of scenes (only on play list)	p. 107

PLAYING BACK A PLAY LIST (PLAY)

- 1 Press the DISC NAVIGATION button.
- 2 Press the MENU button.
- 3 Use the **◀◀/▶▶/◀◀/▶▶/▶/||** buttons to choose "Play" on the "PlayList" menu screen, and then press the **▶/||** button.
- 4 Use the "Start Playlist" screen to select the play list to be played back, and then press the **▶/||** button.

The selected play list will be played back from the first scene. To cancel playback midway, press the **■** button: The Disc navigation screen of the play list being played back will appear.

Note:

If "Repeat Play: On" is specified, the play list will be repeatedly played back (p. 115).

ADDING SCENES TO PLAY LIST (EDITING PLAY LIST)

1 Press the DISC NAVIGATION button.

2 Press the MENU button.

3 Use the **◀◀/▶▶/◀/▶/▶▶/▶▶▶▶** buttons to choose "Edit" on the "PlayList" menu screen, and then press the **▶▶/▶▶** button.

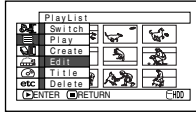

4 Use the "Edit Playlist" screen to select the play list to which you wish to add scenes, and then press the **▶▶/▶▶** button.

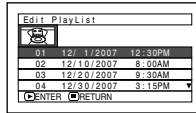

The scenes of the program that was displayed in step 1 will appear in the upper row, and the scenes of selected play list will appear in the lower row.

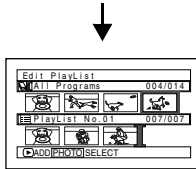

Note:

If you press the DISPLAY button, the recording date/time of the scene in which the cursor is placed on the operation guide will appear. When using the HDD, pressing DISPLAY again will display the recording data of scene; pressing it once more will return to the operating guide. When using a disc, no recording data will appear.

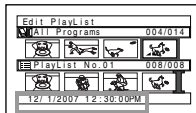

Recording date/time

5 Press the **▶▶▶▶** button to move the cursor to the lower row, and press the **◀◀** or **▶▶** button to select the point where the scene is to be inserted.

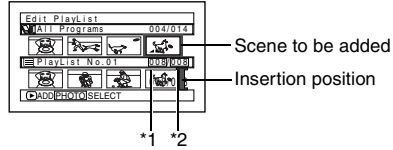

*1: Number of scene before insertion position cursor.
*2: Number of all scenes on play list.

6 Press the **◀◀◀◀** button to move the cursor to the upper row, and press the **◀◀** or **▶▶** button to point the cursor to the scene to be added. You can also select multiple scenes (p. 79).

7 Press the **▶▶/▶▶** button to copy the scene.

After adding scenes is completed, the edited play list will appear. Repeat steps 5 – 7 to add other scenes.

8 Press the **■** button: The screen for verifying exit will appear. Choose "Yes", and then end editing.

Note:

- The "I" mark shows the position where the scene is to be added.
- Each time the DISPLAY button is pressed, the operation guide, the recording date/time of the selected scene, video quality, screen aspect ratio, and the recording length (when using HDD) will appear (see page 72).
- Pressing the **■** button in the middle of adding scenes will display the screen for verifying an exit from "Edit Playlist". Choose "YES" to exit the edition of play list. Choosing "NO" will restore the "Edit Playlist" screen.
- If you press the MENU button in step 5 or 6, the submenu screen for editing play list will appear. You can also use this submenu to add scenes (p. 90).
- If you add a scene with dubbed mark, the mark will also appear on the scene in play list.

DELETING SCENES FROM PLAY LIST (EDITING PLAY LIST)

- 1 Press the DISC NAVIGATION button, and then press the MENU button.
- 2 Display the editing screen of the play list to be edited.

Perform steps 3 – 4 on page 104.
- 3 Move the cursor to the play list in lower row, and place the cursor on scene to be deleted. You can also select multiple scenes (p. 79).

- 4 Press the ►/|| button.

Repeat steps 3 and 4 to delete other scenes.
- 5 Press the ■ button: The screen for verifying exit will appear. Choose “YES”, and then end editing.

Note:

- Place the cursor on scene to be deleted, and then press the DELETE button on remote control: You can also delete the scene on the play list.

ADDING SCENES USING SUBMENU FOR EDITING (EDITING PLAY LIST)

You can use the menu screen to add scenes to a play list.

- 1 Press the DISC NAVIGATION button, and then press the MENU button.
- 2 Display the editing screen of the play list to be edited.

Perform steps 3 – 4 on page 104.
- 3 In the lower row of the play list, place the green “I” mark at the position where you wish to insert a scene.
- 4 Place the cursor on the scene to be added from the upper row. You can also select multiple scenes (p. 79).

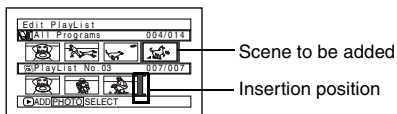

- 6 Choose “Add”, and then press the ►/|| button.

Repeat steps 3 – 6 to add other scenes.

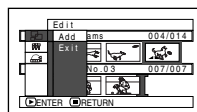

- 7 Press the ■ button: The screen for verifying exit will appear. Choose “YES”, and then end editing.

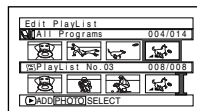

- 5 Press the MENU button.

DELETING SCENES USING SUBMENU FOR EDITING (EDITING PLAY LIST)

You can delete scenes from play list on the editing screen.

- 1** Press the DISC NAVIGATION button, and then press the MENU button.
- 2** Display the editing screen of the play list to be edited.

Perform steps 3 – 4 on page 104.
- 3** Move the cursor to the play list in lower row.
- 4** Place the cursor on the scene to be deleted, and then press the MENU button.
You can also select multiple scenes (p. 79).
- 5** Choose “Delete” on the “Edit” menu screen, and then press the ►/|| button.

Repeat steps 3 – 5 other scenes can be deleted.
- 6** Press the ■ button: The screen for verifying exit will appear.
Choose “Yes”, and then end editing.

Note:

- If all scenes on play list are deleted, the play list itself will also be deleted.

SELECTING SCENES USING SUBMENU FOR EDITING (EDITING PLAY LIST)

You can specify the range of scenes when adding or deleting consecutive multiple scenes to/from play list. This “Select” menu item is useful when selecting consecutive multiple scenes in items for adding or deleting scenes.

- 1** Press the DISC NAVIGATION button, and then press the MENU button.
- 2** Display the editing screen of the play list to be edited.

Perform steps 3 – 4 on page 104.
- 3** Specify the first or last scene of those you wish to select, and then press the MENU button.

To select all scenes, simply press the MENU button.
- 4** Use the ◀◀/▶▶/◀◀/▶▶/▶/|| buttons to choose “Start → Current”, “Current → End”, “All” on the “Select” menu screen, and then press the ►/|| button.

Note:
See page 97 for the status of scenes to be selected.
- 5** Press the ■ button: The screen for verifying exit will appear.
Choose “Yes”, and then end editing.

ARRANGING ORDER OF SCENES (MOVE)

- 1 Press the DISC NAVIGATION button.
- 2 Press the MENU button.
- 3 Use the **◀◀/▶▶/◀◀/▶▶/▶/||** buttons to choose "Select" on the "PlayList" menu screen, and then press the **▶/||** button. Select the play list to be edited, and then press the **▶/||** button.

- 4 Place the cursor on the scene to be moved.

You can also select multiple scenes (see pages 79 and 97).

- 5 Press the MENU button.
- 6 Choose "Scene", "Edit", "Move", and then press the **▶/||** button.
- 7 The "Move Scene" screen will appear: If you are sure you want to move the scene, press the **▶/||** button.

If you want to change the scene selected in step 4, you can do it on this screen.

- 8 Move the "I" mark to the position where you wish to move the scene, and then press the **▶/||** button.

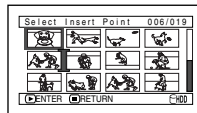

- 9 The screen for verifying move will appear: Choose "YES", and then press the **▶/||** button.

Choose "NO" to cancel move.
After Yes or No setting, the scene select screen will be restored.
Repeat steps 7 – 9 to move another scene.

- 10 Press the **■** button to quit.

Note:

- If you press the MENU button before pressing the **▶/||** button in step 7, the submenu screen will appear (p. 90).
- Only scenes on play list can be moved.
- When using DVD-RAM, scenes can be moved only when "Category: All" is specified (p. 114).

CHANGING TITLE OF PLAY LIST (TITLE)

The play lists have serial numbers in the order you have created them, along with the created dates/times: You can change this title at any time.

- 1 Press the DISC NAVIGATION button.
- 2 Press the MENU button.
- 3 Use the **◀◀/▶▶/◀◀/▶▶/▶/||** buttons to choose "Title" on the "PlayList" menu screen, and then press the **▶/||** button.
- 4 Use the "Playlist Title" screen to select the play list whose title you wish to change, and then press the **▶/||** button.

See "CHANGING TITLE OF PROGRAM (TITLE)" on page 100 for how to enter a title.

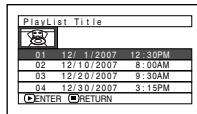

- 5 After changing the title, the Disc Navigation screen on the play list whose title has been changed will appear.

Note:

The registered title can be changed at any time using the same procedure.

DELETING PLAY LIST (DELETE)

- 1 Press the DISC NAVIGATION button.
- 2 Press the MENU button.
- 3 Use the **◀◀/▶▶/◀◀/▶▶/▶/||** buttons to choose "Delete" on the "PlayList" menu screen, and then press the **▶/||** button.
- 4 Use the "Delete Playlist" screen to select the play list you wish to delete, and then press the **▶/||** button.
- 5 The screen for verifying deletion will appear: Choose "YES", and then press the **▶/||** button.

Choose "NO" to cancel deletion.

After Yes or No setting, the Disc Navigation screen of all programs will be restored.

Note:

- Even if you delete a play list, the original scenes stored on HDD/DVD will not be deleted.
- If any play list is deleted, the number of play lists will automatically be revised. (For example, if the No. 2 play list is deleted, the No. 3 play list will become No. 2 play list.)

Go To

From the Disc Navigation screen, you can jump to the first scene or last scene, and playback will start from that point.

MOVING TO BEGINNING (END) OF HDD/DVD/CARD

- 1 Press the DISC NAVIGATION button.
- 2 Press the MENU button.
- 3 Use the ◀◀/▶▶/◀◀/▶▶/▶▶/|| buttons to choose "Top" or "End" on the "Go To" menu screen, and then press the ▶▶/|| button.
- 4 Press the ▶▶/|| button to start playback.

HDD/DVD/Card Management

INITIALIZING HDD/DVD/CARD

Initializing the HDD, a DVD-RAM/DVD-RW/+RW or card will allow you to delete any recorded contents. Before using a DVD-RW/+RW on this video camera/recorder, you must format it.

Before You Begin

- Be sure to use the AC adapter/charger to power the DVD video camera/recorder for initialization. If the DVD video camera/recorder is turned off during initialization and the initialization is interrupted, incorrect initialization will result and the incorrectly initialized disc will be unusable.
- If you insert a brand-new DVD-RW/+RW, message "DVD is not formatted" will appear: Initialize the disc, following the subsequent messages (p. 41).

- 1 Press the DISC NAVIGATION button.
- 2 Press the MENU button.
- 3 Use the ◀◀/▶▶/◀◀/▶▶/▶▶/|| buttons to choose "Format HDD", "Format DVD" or "Format Card" on the "HDD Setting", "DVD Setting" or "Card" menu screen, and then press the ▶▶/|| button.

The screen for verifying "Format HDD", "Format DVD" or "Format Card" will appear.

- 4 Choose "YES", and then press the ▶▶/|| button.

When using DVD-RW, a screen for prompting you to choose the VF or VR mode will appear.

Choose "NO" to cancel initialization.

Note:

- If you wish to delete all recorded contents, it is recommended that you use initialization, which will delete all the scenes in much less time than using the scene delete function.
- Initialization will delete all the recorded contents on HDD, disc or card: Be careful not to delete data by mistake.
- It may not be possible to initialize a disc with many scratches or dirt: Such a disc cannot be used (p. 10).
- This DVD video camera/recorder may not recognize some discs or cards that have been initialized on PC or a device other than this DVD video camera/recorder.
- If you attempt to initialize a disc or card in this DVD video camera/recorder when it is connected to PC via PC connection cable, the disc or card may not be initialized and may be unusable on this DVD video camera/recorder.
- If you choose the VR mode when initializing a finalized DVD-RW (VR-mode), the finalization will not be released. (The DVD-RW will be a finalized disc without any recorded data, and recording will be possible on it.)
Choosing the VF mode will release the finalization of the disc.

PROTECTION

You can protect the HDD and a DVD-RAM/DVD-RW (VR-mode) in order to prevent recorded images from being erased or edited by mistake. Further recording will not be possible on protected disc until the protection is released.

- 1 Press the DISC NAVIGATION button.
- 2 Press the MENU button.
- 3 Use the **◀◀/▶▶/◀◀/▶▶/▶/||** buttons to choose "Protect HDD" or "Protect DVD" on the "HDD setting" or "DVD Setting" menu screen, and then press the **▶/||** button.
- 4 The screen for verifying protection will appear:

Choose "YES", and then press the **▶/||** button.
 Choose "NO" to cancel protection.
 After "YES" or "NO" setting, the Disc Navigation screen will be restored.

Note:

- To release protection, perform steps 1-3: The screen for verifying the release of protection will appear. Choose "YES" to release the protection.
- If disc protection has been engaged on another device, it may not be releasable on this DVD video camera/recorder: Use the original device that protected the disc to release the protection.

VERIFYING REMAINING FREE SPACE ON DISC OR CARD (CAPACITY)

- 1 Press the DISC NAVIGATION button.
- 2 Press the MENU button.
- 3 Use the **◀◀/▶▶/◀◀/▶▶/▶/||** buttons to choose "Capacity" on the "HDD Setting", "DVD Setting" or "Card" menu screen, and then press the **▶/||** button.

- 4 Press the **■** button to quit.
 The Disc Navigation screen will be restored.

Note:

If the HDD is protected, or a write-protected disc or locked card is used, the remaining space will always be displayed as "0".

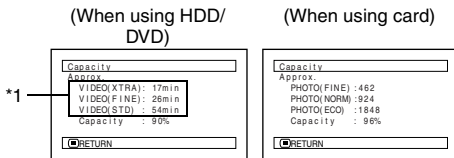

*1 With DVD-RW (VF-mode)/DVD-R: The quality mode first used for recording with disc will appear.

UPDATING CONTROL INFORMATION OF HDD/DVD-RAM/DVD-RW (VR-MODE) (UPDATE CONTROL INFO.)

Disc Navigation in this DVD video camera/recorder handles information on scenes, such as thumbnail, skip, fade, in a particular manner. If you use another device to edit a disc recorded on this DVD video camera/recorder, and then use the data again with Disc Navigation in this DVD video camera/recorder, the Disc Navigation may not appear normally. If this happens, use the Update Control Info function to update the data.

Before You Begin

- When using the AC adapter/charger to power the DVD video camera/recorder for updating control information, make sure that power is not turned off during updating. If the DVD video camera/recorder is turned off during updating and the updating is interrupted, the control information will not be updated correctly.

- 1 Press the DISC NAVIGATION button.
- 2 Press the MENU button.
- 3 Use the **◀◀/▶▶/◀◀/▶▶/▶/||** buttons to choose "Update Control Info." on the "HDD Setting" or "DVD Setting" menu screen, and then press the **▶/||** button.

The screen for verifying "Update Control Information" will appear.

- 4 Choose "YES", and then press the **▶/||** button.

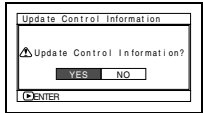

The message for proceeding will appear, and then the Disc Navigation menu screen will be restored. A black screen may appear while the message for updating is displayed. Choose "NO" to cancel updating.

Note:

- It may take time to update the control information if the HDD/disc has many recorded scenes.
- Even if control information is updated, some discs will be unusable on Disc Navigation of this DVD video camera/recorder.

HDD

DELETING DATA ON HDD (FULL FORMAT)

Executing "Format HDD" in "HDD Setting" to delete data on HDD will only change the file control information: It will not delete the data completely. When discarding or transferring this DVD video camera/recorder, be sure to delete any personal data on the HDD in order to prevent it from leaking out.

Before You Begin

- Use the AC adapter/charger to power the DVD video camera/recorder when completely deleting the data on the HDD: This is not possible with a battery.
- If power is turned off and Full Format is interrupted midway, normal deletion will not be possible.
- Executing Full Format will delete all data on the HDD. Save any important data on DVD before starting complete deletion.
- It will take approx. 30 minutes for complete deletion: In rare case, it may take more than one hour.

- 1 Press the DISC NAVIGATION button, and then the MENU button.
- 2 Use the **◀◀/▶▶/◀◀/▶▶** buttons to choose "HDD Setting", "Full Format", and then press the **▶/||** button: The "HDD Full Format" screen will appear.

- 3 Choose "YES", and then press the **▶/||** button. The HDD will be completely cleared. To cancel clear, choose "NO": The Disc Navigation screen will be restored.

Note:

- Pressing the **■** (stop/cancel) button during full formatting will stop the formatting. Take care, however: Even if full formatting stops midway, all data on HDD will be deleted.

FINALIZING DVD-RW/DVD-R/+RW (FINALIZE DVD)

Before You Begin

- Be sure to use the AC adapter/charger to power the DVD video camera/recorder when finalizing a DVD-RW/DVD-R/+RW. Finalization cannot be executed using a battery. If the DVD video camera/recorder is turned off during finalization and the finalization is interrupted, incorrect finalization will result, and at worst, the disc may be damaged.

If you want to play back a DVD-RW/DVD-R recorded/dubbed on this DVD video camera/recorder, using a device conforming to 8 cm DVD disc – such as a DVD recorder/player, etc. – you must finalize the disc on this DVD video camera/recorder.

If you wish to display the DVD video menu when playing back a +RW on a DVD player or DVD recorder, finalize it using the Disc Navigation menu.

No further recording/dubbing can be done on a finalized DVD-RW (VF-mode)/DVD-R/+RW. You can, however, unfinalize the DVD-RW (VF-mode)/+RW so that other scenes can be recorded/dubbed on it.

Additional recording/dubbing is possible on a finalized DVD-RW (VR-mode): Unfinalizing is not necessary.

- 1 Press the DISC NAVIGATION button.
- 2 Press the MENU button.
- 3 Use the **◀◀/▶▶/◀▶/▶▶/▶/||** buttons to choose “Finalize DVD” on the “DVD Setting” menu screen, and then press the **▶/||** button.

The disc will be finalized.

- 4 Choose “YES”, and then press the **▶/||** button. The message showing that the disc is being finalized will appear, and the disc will then be finalized.

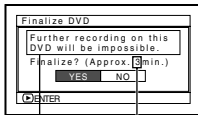

- *1 Displayed only when a DVD-R is used.
- *2 Will vary depending on the recording time.

- 5 When finalization is complete, the Disc Navigation screen of all programs will appear. **▶/||** will appear on the Disc Navigation screen for a finalized disc.

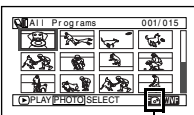

Finalized disc

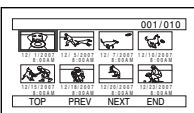

Screen when viewed on DVD recorder/player (DVD-RW (VF-mode)/DVD-R/+RW)

Note:

- Do not use any other device to finalize a disc recorded/dubbed on this DVD video camera/recorder.
- If the disc in the DVD video camera/recorder has already been finalized, you cannot choose “Finalize DVD”.
- The time required to finalize disc that appears on the “Finalize DVD” screen is only for reference.
- The shorter the recording time on disc, the longer it will take to finalize it.
- The second and later finalization will be faster with a disc which has previously been finalized.

● Using FINALIZE button to finalize a disc

Press the FINALIZE button during recording pause: The screen shown in step 4 above will appear. Choose “YES”, and then press the **▶/||** button: Finalizing will start.

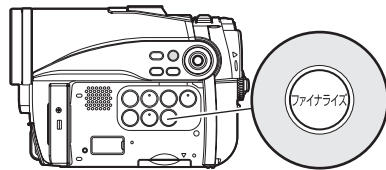

ADDITIONALLY RECORDING ON FINALIZED DVD-RW (VF-MODE)/+RW (UNFINALIZE DVD)

You can unfinalize the DVD-RW (VF-mode)/+RW finalized on this DVD video camera/recorder so that additional recording can be done on it.

1 Press the DISC NAVIGATION button.

2 Press the MENU button.

3 Use the **◀◀/▶▶/◀◀/▶▶/▶/||** buttons to choose "Unfinalize DVD" on the "DVD Setting" menu screen, and then press the **▶/||** button.

The screen for verifying unfinalization will appear.

4 Choose "YES", and then press the **▶/||** button.

The message showing that the disc is being unfinalized will appear, and the disc will then be unfinalized.

Note:

- A finalized DVD-RW (VR-mode) can be recorded as is, without being unfinalized.

DISPLAYING DUBBED/UNDUBBED SCENES IN LIST (CATEGORY)

You can display all scenes recorded on HDD in this DVD video camera/recorder, by dividing them into those dubbed to DVD and not yet dubbed, on the Disc Navigation screen.

- 1 Press the DISC NAVIGATION button, and then press the MENU button.
- 2 Use the **◀◀/▶▶/◀◀/▶▶/▶/||** buttons to choose “Others”, “Category”, and then press the **▶/||** button.
- 3 Choose the option to be set, and then press the **▶/||** button:
“All”: All scenes will be displayed in chronological order of recording regardless of whether they have been dubbed or not.

“Dubbed”: Only scenes with dubbed marks will be displayed in chronological order recording.

“Un Dubbed”: Only scenes without dubbed marks will be displayed in chronological order of recording.

Note:

- Dubbed mark will appear on thumbnails of scenes dubbed to DVD.
- Exiting the Disc Navigation screen will return “Category” to “All”.
- To dub only the scenes with dubbed marks, choose “Dubbed”, and then execute “Select” dubbing.

DISPLAYING MOVIES OR STILLS INDEPENDENTLY (CATEGORY)

If you insert a DVD-RAM that includes photos recorded on a DVD video camera/recorder other than DZ-HS403/HS401, the scenes on the disc will be displayed in the order of recording, regardless of whether they are movies or stills.

Scenes recorded on this DVD video camera/recorder will be displayed in the order of recording regardless of whether they are movies or stills. You can use the Disc Navigation screen to switch this display to stills only or movies only.

DZ-HS403/HS401 cannot record any photos on a HDD/DVD.

- 1 Press the DISC NAVIGATION button.
- 2 Press the MENU button.
- 3 Use the **◀◀/▶▶/◀◀/▶▶/▶/||** buttons to choose “Category” on the “Others” menu screen, and then press the **▶/||** button.

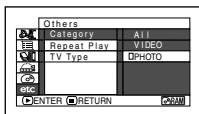

- 4 Specify the desired option for display, and then press the **▶/||** button.

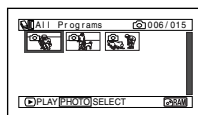

(When “PHOTO” is specified)

- All: To display all scenes, movies or stills, in the order of recording.
- VIDEO: To display only movies in the order of recording.
- PHOTO: To display only photos in the order of recording.

Note:

- When the Disc Navigation screen is finished, “Category: All” will be restored.

PLAYING BACK SCENES REPEATEDLY (REPEAT PLAY)

1 Press the DISC NAVIGATION button.

2 Press the MENU button.

3 Use the **◀◀/▶▶/◀◀/▶▶/▶▶/||** buttons to choose "Repeat Play" on the "Others" menu screen, and then press the **▶▶/||** button.

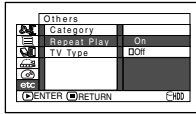

4 Choose "On", and then press the **▶▶/||** button: Playback will start.

Choose "Off" to cancel Repeat Play setting.

●When Repeat Play is set

If one scene has been specified: When playback of the last scene is finished, playback of all scenes will repeat from the first scene.

If the range for playback has been specified: Playback of the scenes in that range will repeat. See page 79 and 97 when selecting multiple scenes.

●To release Repeat Play

Use one of the following 3 methods to release:

- Choose "Off" in step 4 on the left.
- Turn the DVD video camera/recorder off once.
- Press the DISC EJECT button to remove the disc.

Note:

- Press the **■** button to terminate playback. However, the Repeat Play setting will not be canceled.
- When using a DVD-RAM, photos will also be played back repeatedly.
- Repeat playback will not function when playback is instructed from the recording pause status.

PLAYING BACK WIDE-MODE IMAGES ON 4:3 DISPLAY TV (TV TYPE)

If you connect the DVD video camera/recorder with a disc recorded in wide mode to a TV with 4:3 display only and play it back, vertically long images will appear. You can specify "TV type: 4:3" to display 4:3 images on the TV.

1 Press the DISC NAVIGATION button.

2 Press the MENU button.

3 Use the **◀◀/▶▶/◀◀/▶▶/▶▶/||** buttons to choose "TV type" on the "Others" menu screen, and then press the **▶▶/||** button.

4 Choose "4:3", and then press the **▶▶/||** button.

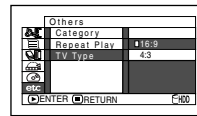

SLIDE SHOW (CONTINUOUS PLAYBACK OF STILLS)

If you play back stills recorded on a card, the DVD video camera/recorder will enter the playback pause status after each still is played back. Setting Slide Show allows you to continuously play back stills.

1 Press the DISC NAVIGATION button.

2 Press the MENU button.

Use the **◀◀/▶▶/◀◀/▶▶/▶▶/||** buttons to choose "Slide Show", "Start", and then press the **▶▶/||** button.

Start: To start a slide show.

When playback is finished, the DVD video camera/recorder will enter the playback pause status at the final still.

Pressing the **■** button will restore the Disc Navigation screen.

Note:

- With slide show, playback will start from the first photo on card regardless of the position of cursor or whether you attempt to select scenes.
- If you press the **■** button or turn the DVD video camera/recorder off, Slide Show will be canceled.

Viewing on TV Screen

CONNECTING TO A TV

Use the provided AV/S input/output cable to connect the DVD video camera/recorder to a TV as follows:

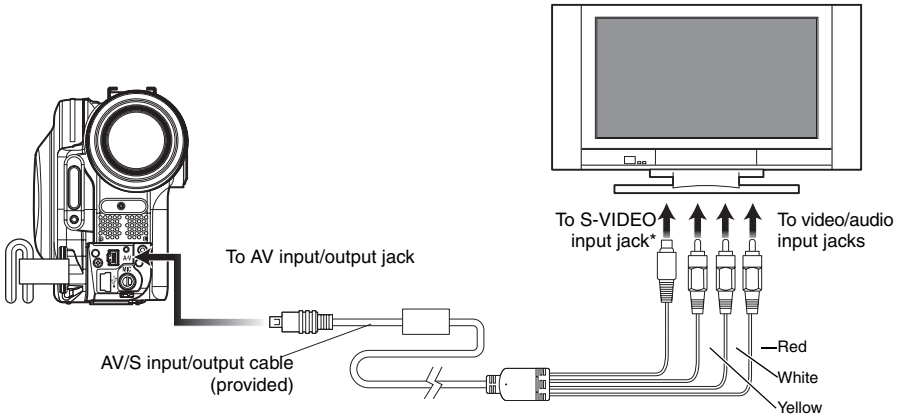

* If your TV has an S-VIDEO input jack, you can connect the S-VIDEO plug to it.

Note:

- Using S-VIDEO will deliver clearer playback status.
- Before connecting, make sure that the volume on TV is turned down: Forgetting this may cause howling from the TV speakers.
- Insert the AV/S input/output cable plugs into jacks straight: Obliquely inserting them could damage the jacks.

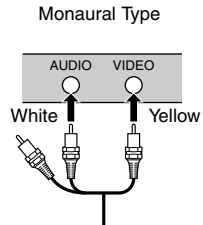
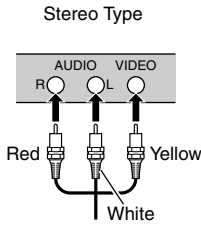
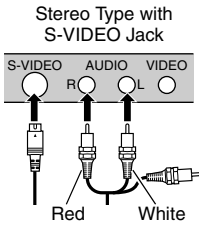

VIEWING ON TV SCREEN

- 1 Turn the TV on and set the input selector to “VCR” whichever applicable Video input.

Refer to the TV instruction manual for how to switch the TV input.

- 2 Turn the DVD video camera/recorder on.

The image that the DVD video camera/recorder is seeing will appear on the TV screen.

You can also monitor the image on the LCD screen or viewfinder of the DVD video camera/recorder.

- 3 Perform playback, recording or editing.

You can perform playback, recording or editing on Disc Navigation while checking on TV screen.

Note:

- Adjust the volume of sound on TV.
- The infrared remote control is useful when operating the DVD video camera/recorder while viewing an image on TV screen. However, if you use a Hitachi VCR, the remote control may inadvertently operate the VCR if it is near the DVD video camera/recorder. To prevent this, set the remote control code of the VCR to a position other than “VCR2”.
- Information during recording and playback will appear on the TV screen: You can also switch off the display during recording. Refer to “SETTING ON-SCREEN DISPLAY OUTPUT ON OR OFF (OSD OUTPUT)” on page 69.
- When copy-guarded disc is played back, no image will appear on TV screen.
- If you use TV with wide mode (aspect ratio 16:9) and set the TV to the wide mode, the entire Disc Navigation display may not be displayed on the TV screen. If this happens, release the wide mode setting on TV (see the TV instruction manual for releasing the wide mode).

Playback on DVD Recorder/Player

PLAYING BACK DVD-RAM/DVD-RW (VR-MODE)

You can use a DVD recorder or DVD player that conforms to DVD-RAM/DVD-RW (VR-mode) to play back 8 cm DVD-RAM/DVD-RW (VR-mode) recorded on this DVD video camera/recorder.

- 1 Insert the disc into the DVD recorder/player and play it back.

See the instruction manual for DVD recorder/player.

Note:

- When playing back disc on another device, the Disc Navigation display will be different from the one on this DVD video camera/recorder.
- Finalizing DVD-RW (VR-mode) may be necessary.
- Do not insert a DVD-RW (VR-mode) that was recorded on this DVD video camera/recorder into a device that does not conform to 8cm DVD-RW (VR-mode): Doing so may make the disc unusable.
- DVD-RAM/DVD-RW (VR-mode) recorded on this DVD video camera/recorder can be played back on other DVD recorder/players or other devices conforming to 8 cm DVD-RAM/DVD-RW (VR-mode), but playback on all DVD recorder/players is not guaranteed.

PLAYING BACK DVD-RW (VF-MODE)/DVD-R/+RW

- 1 Finalize a recorded DVD-RW (VF-mode)/DVD-R/+RW.

You need to finalize a disc to play it back on DVD recorder/player: See page 112. No further data can be recorded on finalized disc.

Note:

Use this DVD video camera/recorder to finalize the DVD-RW/DVD-R/+RW recorded on the DVD video camera/recorder.

- 2 Insert the disc into the DVD recorder/player and play it back.

See the instruction manual for DVD recorder/player.

Note:

- Do not insert a DVD-RW (VF-mode)/DVD-R that has not been finalized into any DVD recorder: The disc may be unusable.
- Do not insert a DVD-RW (VF-mode)/DVD-R recorded on another DVD recorder and not finalized, in this DVD video camera/recorder: Doing so will make the disc unusable.
- A recorded +RW is automatically finalized when it is removed from the DVD video camera/recorder even if you do not use the Disc Navigation function to finalize it (p. 112) (auto-finalize). An auto-finalized +RW can be played back on a DVD recorder/player, etc., but no DVD video menu will appear. To display the DVD video menu on a DVD recorder/player, etc., finalize the +RW using the Disc Navigation function before playing it back on a DVD recorder/player, etc.
- A +RW with a shorter recording time may not be playable on a DVD recorder/player, etc. if it has been auto-finalized. In this case, use the Disc Navigation function to finalize the +RW.
- DVD-RW (VF-mode)/DVD-R/+RW recorded on this DVD video camera/recorder can be played back on other DVD recorder/players or other devices conforming to 8 cm DVD-RW (VF-mode)/DVD-R/+RW, but playback on all DVD recorder/players is not guaranteed.
- Playback may not be possible on some DVD recorder/players, or it may depend on the recorded status of DVD-RW (VF-mode)/DVD-R/+RW: In such cases, play back the DVD-RW (VF-mode)/DVD-R/+RW on this DVD video camera/recorder. Also, playback on DVD recorder/players may stop momentarily between scenes.

Recording (Dubbing) Images

Before You Begin

- Before connecting this DVD video camera/recorder to another device, be sure to turn both devices off.
- Insert a recordable disc*¹ or card*² into this DVD video camera/recorder (see pages 26 and 27).
- *¹ No photo can be recorded.
- *² Only photos can be recorded: No video can be recorded.
- If you operate the DVD video camera/recorder connected to another device, always power the camera/recorder from AC outlet using the AC adapter/charger.
- If you use a Hitachi VCR, it will be operated by the remote control* provided with the DVD video camera/recorder. When recording an image from a Hitachi VCR, change the remote control code of the VCR to other than "VCR2".

RECORDING (DUBBING) IMAGES FROM OTHER VIDEO DEVICE

You can record (dub) images from other video devices to disc or card in this DVD video camera/recorder.

Use the AV/S input/output cable (provided) to connect the DVD video camera/recorder to the other video device as follows:

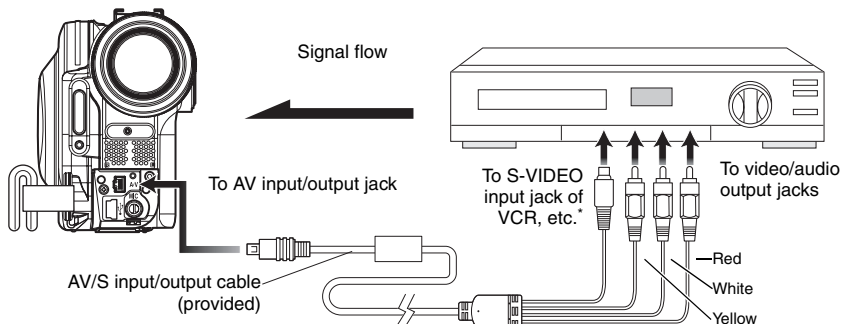

* If the video device to be connected has an S-VIDEO input jack, you can connect it to the DVD video camera/recorder.

- 1 Set the input source on the DVD video camera/recorder to "LINE (L IN)".

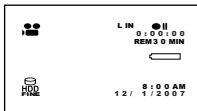

Switch the input referring to "Input Source" on p. 67.

- 2 Turn on the connected device, and start playback.

The picture will appear on the LCD screen or viewfinder of this DVD video camera/recorder.

- 3 Press the REC button.

Recording will start on this DVD video camera/recorder.

The operation of this line-input recording is the same as for recording movie.

Press the PHOTO/SELECT button when recording a photo.

Note:

- Reduce the volume of external input sound heard from the built-in speaker: The loud volume may cause noise to enter the recorded image.
- The recorded contents can be played back in the same manner as when playing back camera images recorded on this DVD video camera/recorder.
- The "Input Source" setting will return to "CAMERA" whenever DVD video camera/recorder is turned off.
- Recording of most images is prohibited by the copy-guard signal to protect the copyright, except for images recorded on camcorders for personal enjoyment. "COPY PROTECTED" appears in these images: They cannot be recorded on this DVD video camera/recorder.
Typical copyright protected images include those of DVD video, LD, recorded video tapes, some parts of digital satellite broadcasts, etc.
- If a video signal that cannot be read by this DVD video camera/recorder is present – even in images recorded on camcorder for personal enjoyment without copy-guard signal – the input image may not be recorded normally.
- If the input signal is interrupted by switching the channel on TV or switching the signal using video selector, normal recording cannot be performed.
- No "copy-once" image can be recorded on this DVD video camera/recorder even if a disc conforming to CPRM (Content Protection for Recordable Media) is used.
- When recorded images are played back on PC, black bands may appear at the top/bottom and on the left and right of screen.

RECORDING (DUBBING) IMAGES ON OTHER VIDEO DEVICES

You can record (dub) images played back on this DVD video camera/recorder, on other video devices.

Use the AV/S input/output cable (provided) to connect the DVD video camera/recorder to another video device as shown in the following figure:

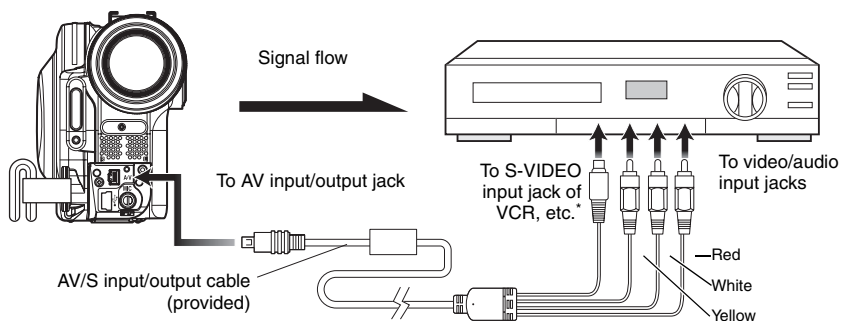

* If the video device to be connected has an S-VIDEO input jack, you can connect it to the DVD video camera/recorder.

- 1 Press the DISC NAVIGATION button.
- 2 Select a scene to be played back.
- 3 Set the channel of the connected video device to an external input.
- 4 Press the playback (▶/||) button on this DVD video camera/recorder and the record button on connected device: The DVD video camera/recorder will start playback and the recorded device will record (dub) it.

Note:

- Using S-VIDEO will enable you to record clearer images.
- Reduce the volume of external input sound heard from the built-in speaker: The loud volume may cause noise to enter the recorded image.
- It is recommended that you use Disc Navigation to create a play list including the scenes to be dubbed among the scenes recorded on this DVD video camera/recorder (p. 102).

Connecting to PC

Software Provided

You can utilize on PC the videos and photos recorded on this DVD video camera/recorder, using the PC connection cable and software CD-ROM provided, or generally available software. The provided CD-ROM contains the following software for Windows and Macintosh:

Windows

ImageMixer 3

This allows you to import the images recorded on the DVD video camera/recorder into PC. You can play back imported images, cut-edit them, add titles and BGM, and edit videos, e.g., attach image switching effect.

You can also create a DVD-Video (DVD-RW/DVD-R) and DVD-VR (DVD-RAM/DVD-RW) by importing the images recorded on the DVD video camera/recorder into PC.

Macintosh

ImageMixer 3 Mac Edition for DVDCAM

This allows you to import the images recorded on the DVD video camera/recorder into Macintosh as an MPEG file.

You can combine imported images, cut-edit them, etc.

You can also create a DVD-Video (DVD-RW/DVD-R) by importing the images recorded on the DVD video camera/recorder into Macintosh.

- The following are available on the provided software:

OS		HDD	Disc	Card
Windows	Read	●	●	●
	Write	—	●	—*2
Macintosh	Read	●	●	●
	Write	—	●*1	—*2

*1 No DVD-VR [DVD-RAM/DVD-RW (VR-mode)] can be created.

*2 Writing to card using Explorer/Finder is possible.

Note:

- Finalize the DVD-RW/DVD-R recorded on the DVD video camera/recorder before using it on PC.
- You cannot create a DVD-VR (DVD-RAM/DVD-RW) on the Macintosh software.
- Since the audio format of the MPEG file imported into Macintosh using ImageMixer 3 Mac Edition for DVDCAM is AC3 audio, no audio will be played back even on QuickTime MPEG-2 playback component and only video is played back. Use ImageMixer 3 Mac Edition for DVDCAM to play back imported MPEG files.
- The software provided with this DVD video camera/recorder cannot handle copyright-protected DVDs, such as CPRM and CSS.

The provided software can handle Japanese, English, German, French, Spanish, Italian and Chinese (simplified).

For explanation, this manual uses Windows XP screens for Windows and Mac OS X 10.4 screens for Macintosh.

Requirements of available PC

[When using Windows]

- OS: Windows® 2000 Professional SP3 or higher
Windows® XP Home Edition or higher
Windows® XP Professional Edition or higher
See the following Websites to fine out whether the provided software can be used on Windows Vista:
URL:<http://www.pixela.co.jp/oem/hitachi/e/index.html>
URL: <http://dvdcam-pc.support.hitachi.ca/>
- Computer: IBM PC /AT compatible, with the above OS preinstalled.
- CPU: Intel® Pentium® III 800 MHz or higher; or Pentium® 4, Celeron or AMD® Athlon XP /Duron whose performance is equivalent (Pentium® 4, 1.7 GHz or higher is recommended)
Operation is not guaranteed if the CPU is overclocked or dual CPU is used.
- Memory: Windows 2000 Professional: At least 128 MB (256 MB or more is recommended)
Windows XP Home Edition/Professional Edition: At least 256 MB (512 MB or more is recommended)
- HDD: Free space of at least 300 MB (needed to install the application)
Free space necessary for creating a disc
DVD-Video: At least 14 GB for work folder (at least 28 GB for a double-layer disc).
- Display: Displayable with at least 1024 × 768 pixels and 16 bits (High color)
Graphics accelerator with VRAM of at least 4 MB, compatible with DirectX® 9.0c or higher
- Sound: Sound Blaster or its equivalent
- Other: Environment where DirectX® 9.0c can operate normally

[When using Macintosh]

- OS: Mac OS X v10.3.9, v10.4.2-v10.4.8
The provided software cannot be used on Mac OS X Server.
- CPU: PowerPC G4 1 GHz or higher, PowerPC G5, Intel Core
- Memory: At least 256 MB (512 MB or more is recommended)
- HDD: Free space needed for installation: Approx. 30 MB
To create a DVD, free space of at least twice that of disc to be created will be required.
- Graphics: At least 1024 × 768 pixels (full-color is recommended)
- Compatible drive:
SuperDrive mounted in Macintosh in standard

The slot-in type drive of Macintosh is not compatible with an 8 cm disc: Be sure not to use the drive, since a disc inserted by mistake cannot be removed.

Note:

- You must have the administrator authority of the PC before installing software.
- Operation is not guaranteed in the following cases:
 - When connected via USB hub
 - Multiprocessor is not supported.
 - When used on your custom-made PC
- Even when your PC satisfies the above conditions of available PC, malfunction may result or restriction in use may occur, depending on the combination of other software in PC or peripheral devices.
- Operation is not guaranteed on all PCs that satisfy the above recommended environment.

Installing Software

[When using Windows]

- 1 Turn the PC on.
If you have been using the PC, terminate all running software programs.
- 2 Insert the provided CD-ROM into the CD-ROM drive of PC.
The installer will automatically start, and the “Choose setting language” screen will automatically appear.
If the “Choose setting language” screen does not appear, use Windows My Computer or Explorer to open the drive in which the CD-ROM is located, and then double-click the setup.exe icon in it. (Extension “exe” may not appear depending on the PC used.)
- 3 Choose the language to be installed.
Choose the language used with ImageMixer 3, and then click “Next”.

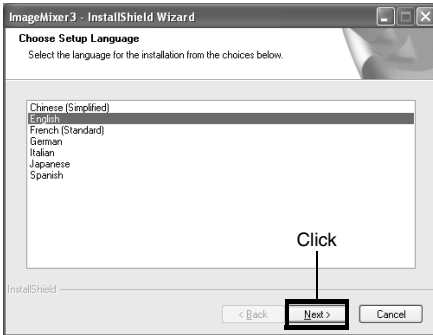

- 4 The “ImageMixer 3” installation screen will appear: Click “Next”.

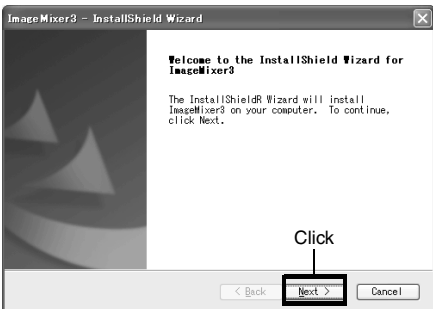

- 5 Checking license agreement:
Carefully read the license agreement: If you accept the contents, choose “I accept the terms of the license agreement”, and then click “Next”.

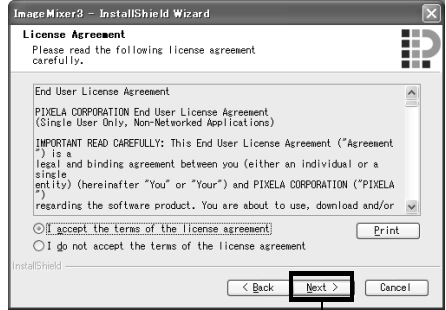

- 6 Choosing the installation destination:
If you do not wish to change the folder in which the software is installed, click “Next”.
If you wish to change the folder, click “Change”, designate the installation location, and then click “Next”.

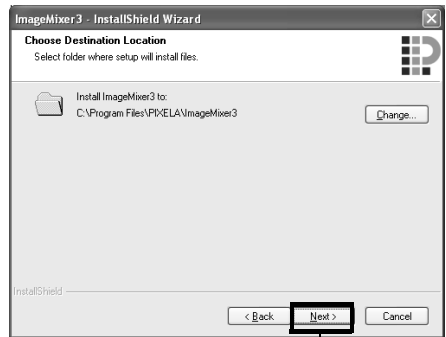

7 Choosing video system:

The screen for setting the video system will appear, and then click "Next".

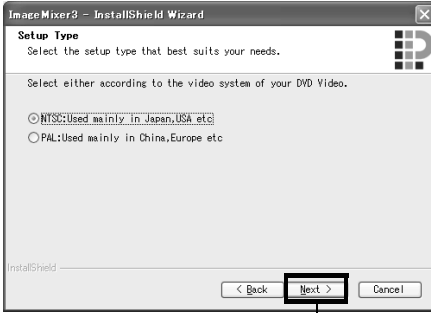

Click

8 Executing installation:

The setups for installation are now complete. Click "Install" to execute installation.

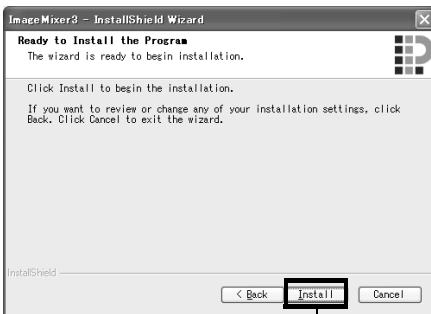

Click

Important information for customers who use Easy CD Creator 5 made by Roxio Corporation:

If ImageMixer 3 provided with this DVD video camera/recorder is installed, Easy CD Creator 5 may not operate normally. The screen shown below will appear after you click "Install":

If you are using Easy CD Creator 5, click "Yes", and do not install ImageMixer 3.

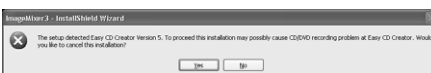

9 After installation is finished, the screen for prompting restart will appear: Click "Finish" to restart the PC.

After restart, remove the CD-ROM from the PC.

Installing the software is now complete.

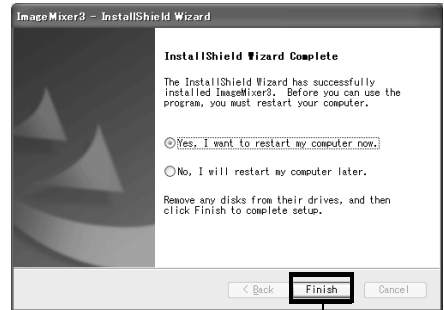

Click

Note:

- After installation is finished, the installation of Direct X[®] may start depending on the PC used: In this case, follow the instructions on screen to install Direct X[®].

[When using Macintosh]

- 1 Turn the Macintosh on, and insert the provided CD-ROM into the CD-ROM drive of Macintosh.
- 2 Double-click the DVDHS7S icon displayed on desktop.
- 3 Double-click the icon of “ImageMixer 3 for DVDCAM.pkg” displayed on screen. The installer will start: Click “Continue”. The “Read Me” screen will appear: Click “Continue”.
- 4 Checking license agreement:
The license agreement screen will appear. Set the language to be used when installing the software, and then carefully read the license agreement: If you agree with the contents, choose “Continue”. If you accept the license agreement, click “I agree”.
* With the provided software for Macintosh, the language used with OS will automatically be installed.

- 5 Choose the installation destination and type of installation, and click “Continue”. Then click “Install”.
Follow the instructions on screen for operation: Installation will start.
- 6 After installation is finished, the screen for exit will appear: Click “Close”.
The screen for installation will close and installation will be complete: Remove the CD-ROM.

Note:

- You must have the administrator authority of the PC before installing software.

Setting language when installing

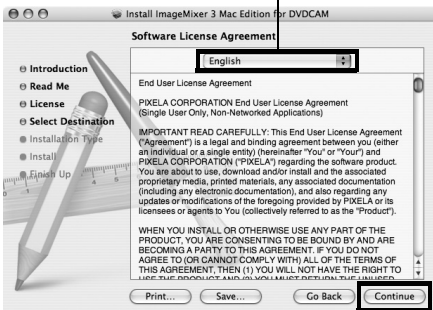

Click

Connecting to PC via PC Connection Cable

Use the provided PC connection cable to connect the DVD video camera/recorder to PC as shown below.

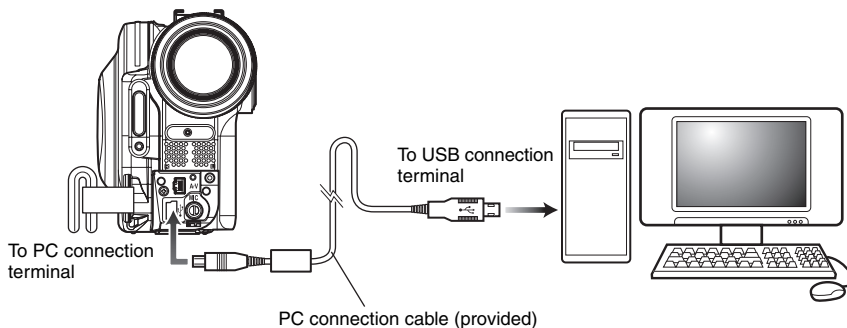

Note:

- The PC connection cable does not supply power to the DVD video camera/recorder: Use the AC adapter/charger to power the DVD video camera/recorder.
- Before connecting the DVD video camera/recorder to PC, disconnect any cables other than the PC connection cable and AC adapter/charger.
- When connecting the DVD video camera/recorder to PC, the ACCESS/PC indicator will light green. While HDD or a disc is being accessed, the indicator will light or blink orange. While an SD memory card is being accessed, the CARD ACCESS indicator will light or blink red.
- When this DVD video camera/recorder is connected to PC, nothing will appear on the LCD monitor or in the viewfinder.
- When using Windows, the DVD video camera/recorder can be connected to a USB1.1 port of PC. However, since the data transfer speed is lower than when connecting to a USB2.0 port, lost frames may occur or the process may take more time.
- Read "Cautions when connecting DVD video camera/recorder to PC" on page 140.

The power switch of this DVD video camera/recorder has three modes: HDD mode when it is set to "HDD", Disc mode when it is set to "DVD", and Card mode when it is set to "SD".

* The mode cannot be switched while the DVD video camera/recorder is connected to PC. To switch, unplug the PC connection cable from the PC (see page 130), and then change over the power switch.

If you connect the DVD video camera/recorder to PC via PC connection cable, the PC will automatically recognize the DVD video camera/recorder. After recognition is finished, it may be prompted to restart the PC: In this case, follow the instruction and restart the PC.

When connecting the DVD video camera/recorder to PC, the DVD video camera/recorder will be recognized as a drive. The drive will appear on screen as follows:

[When using Windows]

If the DVD video camera/recorder is connected to PC with its power switch set to “HDD” or “DVD”, it will be recognized as an optical disc drive, and a disc set in the DVD video camera/recorder can be accessed. (The shape of icon and drive name, such as G:, will depend on the software environment used.)



HDD_CAMERA (G:)



DVD_CAMERA (G:)

If the DVD video camera/recorder is connected to PC with its power switch set to “SD”, it will be recognized as a removal disk, and a card set in the DVD video camera/recorder can be accessed. (The drive name, such as G:, will depend on the software environment used.)



Removable disk (G:)

[When using Macintosh]

If the DVD video camera/recorder is connected to Macintosh USB port with the power switch set to “HDD” or “DVD”, it will be recognized as a removable drive, and the icon shown on the right will appear. (The shape of icon and drive name will depend on the software environment used.)



HDD_CAMERA



DVD_CAMERA

If the DVD video camera/recorder is connected to Macintosh USB port with the power switch set to “SD”, it will be recognized as a removable drive, and the icon shown on the right will appear.

Double-click this icon: The contents of card can be checked.

(The shape of icon and drive name will depend on the software environment used.)



DVD_CAMERA

● Handling photos

Photos are recorded on a SD memory card in this DVD video camera/recorder in JPEG format: Use the application that conforms to the JPEG images.

The following shows how to import photos into PC/Macintosh:

Insert an SD memory card with photos recorded into the DVD video camera/recorder, and connect it to PC/Macintosh. Double-click the removable disc icon displayed on the screen: The contents on the card will appear.

The photos recorded on the DVD video camera/recorder are stored in “DCIM” - “100*HPNX1” folder on card: Drag and drop them to PC to import them.

* The number may be different if the card was recorded on another DCF conforming device.

The following operations are not possible on the DVD video camera/recorder while it is being connected to PC:

- Camera operation using operation buttons on DVD video camera/recorder.
- Ejection of disc using DISC EJECT button on DVD video camera/recorder.
- Power off using power switch.
- Do not use Explorer to operate any video files recorded on disc: Use the provided software.
- HDD, disc and card cannot simultaneously be accessed.

A disc/card loaded in the DVD video camera/recorder can be ejected by operating the PC.

- The disc and SD memory card can be replaced even though the DVD video camera/recorder is turned off or it is not connected.

●When removing disc

[When using Windows]

Use Windows Explorer or My Computer to choose the drive icon of DVD video camera/recorder.

→ Right-click the mouse.

→ Choose “Eject”.

→ The cover of disc insertion block on DVD video camera/recorder will open.

Insert another disc and close the cover: The disc will be recognized.

[When using Macintosh]

Place the drive icon of this DVD video camera/recorder (displayed on desktop) in Trash Box: The cover of disc insertion block on DVD video camera/recorder will open. Load another disc and close the cover: The disc will be recognized.

●When removing SD memory card

[When using Windows]

Make sure that the SD memory card is not being accessed by the PC software on PC, and that the CARD ACCESS indicator on DVD video camera/recorder (see page 8) is not lit or blinking, and then remove the SD memory card from DVD video camera/recorder.

The CARD ACCESS indicator may be lit or blinking for a while after a file in PC is written to the SD memory card: Wait until the CARD ACCESS indicator goes out. It will sometimes take no less than a few minutes.

[When using Macintosh]

Drag the removal drive icon (displayed on desktop) and place it in Trash Box. After making sure that the icon disappears from desktop, remove the SD memory card from the card insertion slot of this DVD video camera/recorder.

USING DISC IN DVD DRIVE BUILT INTO PC

If you have a PC with the drive conforming to the disc used, and the application software, you can directly insert the disc into the drive to use it.

Whether a disc conforms to the DVD drive will depend on the DVD drive: Use a DVD drive that conforms to each disc.

Finalized DVD-RW/DVD-R/+RW can be used with DVD-ROM drive (reading only).

The slot-in type drive of Macintosh is not compatible with an 8 cm disc: Be sure not to use the drive, since a disc inserted by mistake cannot be removed.

Note:

- When writing images edited on PC to a brand-new DVD-RW, do not format the disc on DVD video camera/recorder.
- Some vertically installed and slot-in type drives on PC cannot accept an 8 cm disc.
- An adapter that converts 8 cm CD to 12 cm diameter (for 8 cm CD) cannot be used for any 8 cm DVD-RAM/8 cm DVD-RW/8 cm DVD-R/8 cm +RW.
- If you use, on PC, a DVD-RW/DVD-R/+RW recorded on the DVD video camera/recorder, finalize it on the DVD video camera/recorder (see page 112).
- Some DVD-ROM drives cannot read a DVD-RW/DVD-R/+RW recorded on the DVD video camera/recorder.

BEFORE TERMINATING PC CONNECTION (UNPLUGGING PC CONNECTION CABLE)/CHANGING OVER POWER SWITCH

[When using Windows]

1 Before unplugging the PC connection cable from PC, terminate the application and then click the “Hardware Removal” icon on task tray at the bottom right of Windows screen.

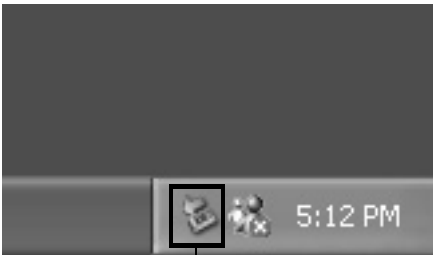

Click

2 Choose “USB mass storage device”. The drive name (E:, etc.) will depend on the PC used.



3 A message showing that “hardware removal” is possible will appear. Unplug the PC connection cable.

* If “hardware removal” results in error, terminate Windows® once, and then unplug the PC connection cable. When using Windows® 2000 Professional, installing Windows® 2000 SP3 or later may resolve the problem. Ask your PC manufacturer or Microsoft Corporation how to get Windows® 2000 SP3.

[When using Macintosh]

When removing the DVD video camera/recorder from PC, choose the drive icon of DVD video camera/recorder (HDD, disc or card), and choose “Eject” in the “File” menu.

Using ImageMixer 3 for Windows

ImageMixer 3 allows you to capture the images recorded on the DVD video camera/recorder into PC, edit the video file, and create a DVD-Video or DVD-VR using the video file.

The following shows the basic operation of ImageMixer 3.

Refer to the electronic instruction manual that can be read on PC for detailed instructions about ImageMixer 3: While ImageMixer 3 is being activated, click “Help” - “ImageMixer 3 Help (H) F1” to display this manual. See the electronic instruction manual for explanation on how to edit video files.

To start ImageMixer 3, double-click the ImageMixer 3 shortcut that was created when it was installed.

* If there is no ImageMixer 3 shortcut on desktop, choose [Start] - [Programs] or [All programs] - [PIXELA] - [ImageMixer 3] - [ImageMixer 3].

Note:

• With scenes recorded on a DVD-RW (VF-mode)/DVD-R/+RW, no recording date/time will appear on ImageMixer 3.

VIEWING IMAGES RECORDED ON HDD/DISC USING PC

* A DVD-RW/DVD-R/+RW recorded on this DVD video camera/recorder must be finalized on this DVD video camera/recorder (see page 112).

1 Connect this DVD video camera/recorder to the USB port of PC.

To view images recorded on a disc, first insert the disc you wish to play back into the DVD video camera/recorder, and then connect the DVD video camera/recorder to the USB port of PC.

2 Start ImageMixer 3.

When ImageMixer 3 starts up, the launcher shown below will appear: Click “Playback/Import Movie”.



Click

3 Choose the camcorder on the library screen. The library screen shown below will appear. Click the camcorder icon shown on the left of screen: The images recorded on HDD (DVD when DVD is being chosen) will appear.

Double-click the thumbnail of scene you wish to play back: Playback of the scene will start on another screen.

Double-click the screen being played back: Playback will appear on a full screen. To exit the full-screen display, double-click the screen again.

To play back images on another disc, click the “Eject” button at the bottom left of library screen, with playback stopped. The cover of disc insertion block on this DVD video camera/recorder will open: Remove the disc and load another disc to be played back.

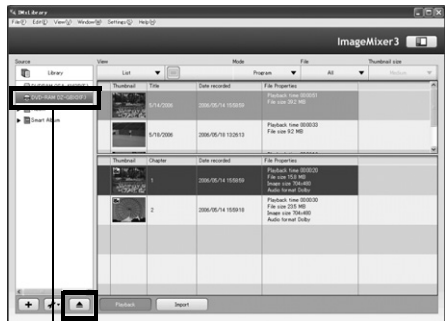

Click

Eject button

Note:

• When connecting the DVD video camera/recorder to a USB1.1 port of PC, the data transfer speed will be insufficient, which could result in lost frames.

CREATING DVD-VIDEO USING IMAGES RECORDED ON HDD/DISC

You can use the images recorded on the DVD video camera/recorder to create a disc that can be viewed on DVD recorders/players.

* A DVD-RW/DVD-R/+RW recorded on this DVD video camera/recorder must be finalized on this DVD video camera/recorder (see page 112).

1 Connect this DVD video camera/recorder to the USB port of PC.
To save images recorded on a disc, first insert the disc you wish to save into the DVD video camera/recorder, and then connect the DVD video camera/recorder to the USB port of PC.

2 Start ImageMixer 3.
When ImageMixer 3 starts up, the launcher shown below will appear: Click “Create DVD-Video”.



Click

3 Click “Create New DVD”.

4 Setting up project.
Set up a project. You can set up the designated save location of edited contents and image quality.
Be sure to choose “NTSC” for the video system.
After setting up the project, click the “OK” button.

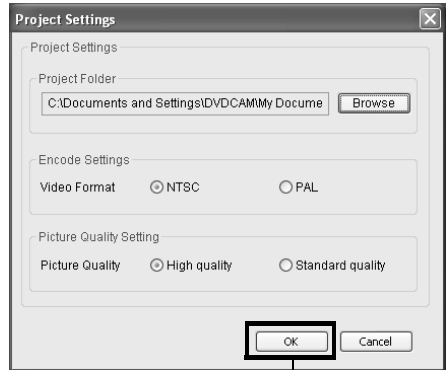

Click

5 On the “Importing Device” screen, choose “Hitachi DVDCAM (HDD)” when the power switch is set to “HDD”; and “Hitachi DVDCAM” when the power switch is set to “DVD”.

If you wish to change the import device, and continue import, unplug the PC connection cable from the PC, and then change over the power switch (see page 127).

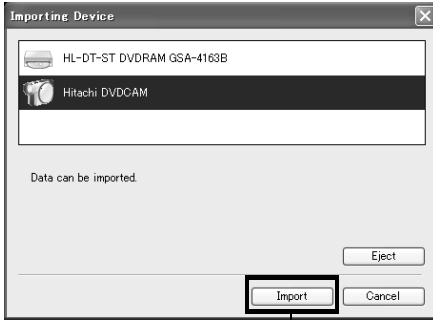

Click

6 Select the images from which you wish to create a DVD-Video, and then click “Import”. The image recorded on HDD, disc will appear. Select the chapter to be imported into PC, and then click “Import”: Importing into PC will start.

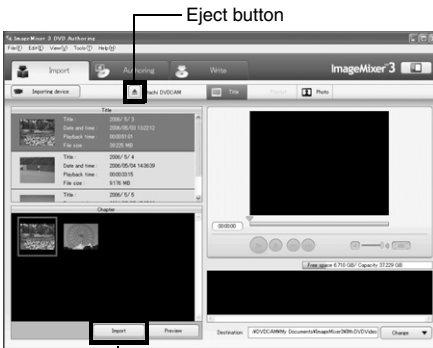

Click

If you wish to import images on another disc after importing images on one disc, click the “Eject” button. The disc insertion block of DVD video camera/recorder will open: Remove the disc, insert the other disc whose recorded images you wish to import, and then close the disc insertion block. After a short while, the images on the disc will appear: Perform the same procedure to

import the images. When the images on DVD-RW (VF-mode)/DVD-R/+RW are imported, the recording date/time will not appear.

Note:

- To import all chapters in the title at once, click “Select all” in the editing menu at the top of screen, and then click “Import”.



- To import multiple chapters, click the desired chapters while holding down the Ctrl key.

7 Click “Authoring” and create a DVD-Video menu.

Clicking “Authoring” will display the editing screen of DVD-Video menu. The video file previously imported into PC will appear in “Source”. Choose the desired video file, and click “Add titles”: The video file will be registered.

When using a video file imported into PC using ImageMixer 3, click “File” to choose the folder in which the video file will be stored.



Click

Clicking “Theme” or “Set title menu” will allow you to change the design of DVD-Video menu.

Choose the type of disc to be created (8 cm / 12 cm / 2-layer) using [Set] - [Configuration].

- 8** Click "Write" to create a DVD-Video.
 Clicking "Write" will display the screen for writing.
 Check "Create disc", perform setting for write, such as choosing DVD write drive, and then set a blank DVD-RW/DVD-R into the drive.
 Clicking "Preview" will allow you to check any image of DVD to be created.

- If a video recorded on the HDD in this DVD video camera/recorder for extended hours is too long for one disc, cut-edit the video so that it can be recorded on one disc. See the on-line instruction manual of ImageMixer 3 for cut-editing of videos. To display the ImageMixer 3 manual, choose "Help", and then "ImageMixer 3 Help (H) F1", while ImageMixer 3 is being executed.

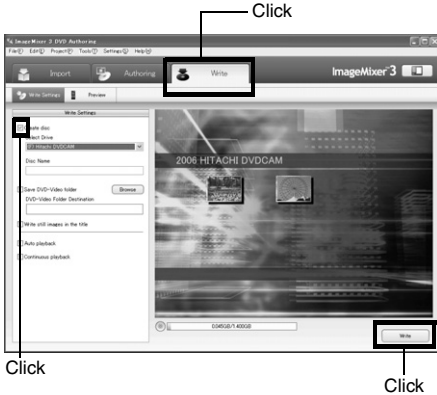

Click the "Write" button: The screen for setting write will appear. After checking the settings, click "OK": Writing will start.

When write is complete, the drive will open to eject the DVD: Creation of an original DVD is now finished.

Note:

- If you load a written DVD-RW in the write drive, the dialog "Are you sure you want to delete the content of disc?" will appear. Deleting the content of disc will erase all data on the disc: Carefully check the contents of disc. Choosing "Yes" will display the screen for choosing the disc erasure method: After checking it, click the "OK" button. Once the contents on disc have been deleted, the cover of disc insertion block on DVD video camera/recorder will open. Close the cover following the message instruction.
- If the disc contains a video file that does not conform to DVD-Video format, the video will be re-encoded, resulting in deterioration of image quality.
- If you execute "File" - "Save project", the halfway operation status can be saved as a project file. Reading in this saved project file will allow you to restart the operation from the saved status.
- A project file will be saved in the project folder that was designated when images were saved, and the file name will be automatically attached.

Using ImageMixer 3 Mac Edition for DVDCAM

ImageMixer 3 Mac Edition for DVDCAM allows you to import the images recorded on this DVD video camera/recorder into Macintosh as a video file, play back the video file, edit it and create a DVD-Video.

The following shows the basic operations of ImageMixer 3 Mac Edition for DVDCAM.

Refer to the electronic instruction manual that can be read on Macintosh for detailed instructions of ImageMixer 3 Mac Edition for DVDCAM: Click "Help" - "ImageMixer 3 Help" while it is starting up.

To start ImageMixer 3 Mac Edition for DVDCAM, double-click the "ImageMixer 3 for DVDCAM" icon in Macintosh HD (startup disk) - "Applications" - "ImageMixer 3 for DVDCAM".

Note:

- The provided software cannot be used to burn a DVD-VR (DVD-RAM/DVD-RW).
- With scenes recorded on a DVD-RW (VF-mode)/DVD-R/+RW, no recording date/time will appear on ImageMixer 3 Mac Edition for DVDCAM.

VIEWING IMAGES RECORDED ON HDD/DISC USING MACINTOSH

A DVD-RW/DVD-R/+RW recorded on this DVD video camera/recorder must be finalized (using this DVD video camera/recorder, see page 112) before it is played back on Macintosh.

1 Connect this DVD video camera/recorder to the USB port of Macintosh.

To save images recorded on a disc, first insert the disc you wish to save into the DVD video camera/recorder, and then connect the DVD video camera/recorder to the USB port of Macintosh.

2 Start ImageMixer 3 for DVDCAM.

3 Choose Hitachi DVDCAM.

Click "Hitachi DVDCAM" displayed on the left of screen: The images recorded on HDD (DVD when DVD is being chosen) will appear.

4 Select the scene you wish to play back and click "Playback".

If you click the scene to be played back, and then click "Playback" at the bottom of screen, the scene will be played back on another screen.

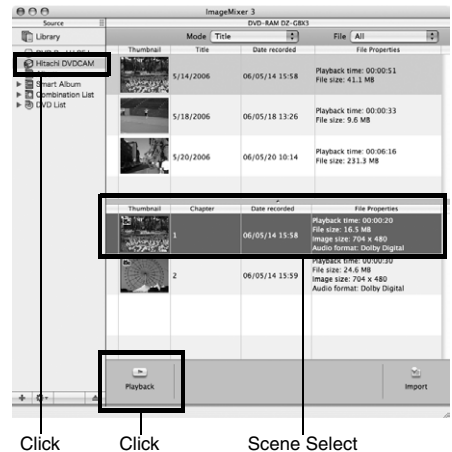

Note:

- If Macintosh has previously been set, the DVD player will start automatically if you load a DVD in the DVD video camera/recorder or Macintosh drive. To cancel automatic start of DVD player, from the "Apple" menu choose "System Preferences", "CDs&DVDs", "When you insert a video DVD", and then "Ignore".
- When connecting the DVD video camera/recorder to Macintosh for playback on a DVD player, etc., the screen for setting the drive region code will appear: Set the region code that matches your local area.
- Normal playback may not be possible depending on the disc recorded status.

IMPORTING IMAGES RECORDED ON HDD/DISC INTO MACINTOSH

ImageMixer 3 allows you to import movie files recorded on HDD/disc into Macintosh as MPEG files. Using ImageMixer 3, you can play back the imported video file, combine images, cut-edit them; and also create a DVD-Video.

- 1 Connect this DVD video camera/recorder to the USB port of Macintosh.
To import images on DVD, load the DVD into the DVD video camera/recorder, and connect it to the USB port of Macintosh.
- 2 Start ImageMixer 3 for DVDCAM.
- 3 Choose Hitachi DVDCAM.
Click "Hitachi DVDCAM" displayed on the left of screen: The images recorded on HDD (DVD when DVD is being chosen) will appear.
- 4 Select the scene you wish to import and click "Import".
Click the scene to be played back, and then click "Import" at the bottom of screen: Importing the scene will start.

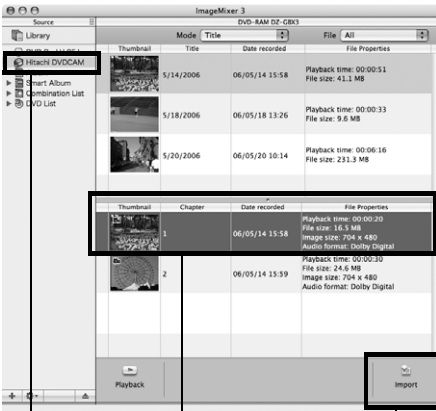

Click

Select

Click

Click "Library" at the top left of screen: The video files imported into Macintosh using ImageMixer 3 will appear in a list as shown below.

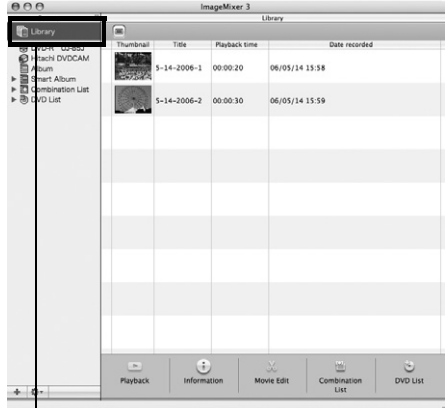

Click

Select a video file on this library screen and click the Playback button at the bottom of screen: The video file can be played back. Also, clicking the "Movie Edit" icon will allow you to cut-edit the video.

Refer to the electronic instruction manual of ImageMixer 3 for details on how to use it (see page 135).

Note:

If you click "Recently Imported Files" in "Smart Album" on the left of screen, only the files recently imported will automatically appear.

If you designate a specific condition, such as recording date, Smart Album will also automatically display the video files collectively. For detailed use of Smart Album, refer to "How to Use" - "Creating Albums" - "Creating Smart Albums".

CREATING DVD-VIDEO USING IMAGES RECORDED ON HDD/DISC

You can use the images recorded on the DVD video camera/recorder to create a disc that can be played on other DVD recorders/players.

* A DVD-RW/DVD-R/+RW recorded on this DVD video camera/recorder must be finalized on this DVD video camera/recorder (see page 112) before importing the images on it.

- 1 Start ImageMixer 3 for DVDCAM.
- 2 Choose Hitachi DVDCAM.
Click "Hitachi DVDCAM" displayed on the left of screen: The images recorded on HDD or disc will appear.
- 3 Select the scene you wish to import and click "Import".
Click the scene to be played back, and then click "Import" at the bottom of screen:
Importing the scene will start.
After importing, click "Library" to make sure that the desired video file has been imported.

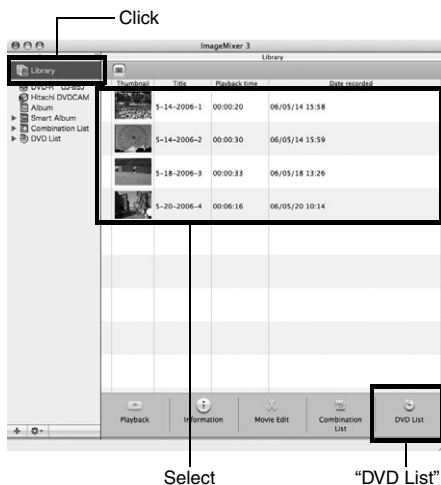

- 4 Create a DVD creation list.
Clicking Library will display a list of video files imported into Macintosh using ImageMixer 3.
Select the video files from which you wish to create a DVD-Video, and then click "DVD List" at the bottom of screen. The screen for selecting the DVD menu design, size of DVD disc to be created (8 cm/12 cm), and picture quality will appear: Choose the desired settings, and click "OK".
The created DVD list will be added.
The DVD list has been registered "Untitled": Double-click "Untitled" to change the name of the DVD list. The name of the DVD list will become the name of the disc.

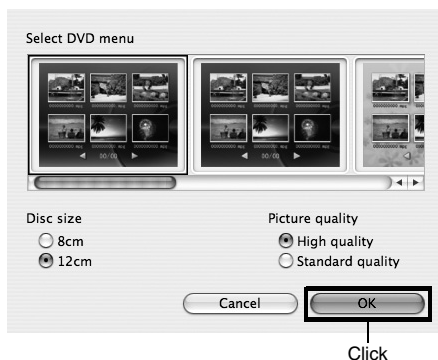

Note:

- You can also use Album or Smart Album to easily prepare a DVD creation list, by selecting the video files from which you wish to create a DVD-Video and clicking "DVD List" at the bottom of screen.
- Even after creating a DVD list, you can drag a video file from the library and drop it to the DVD list on the left of screen: That video file will be added.
- While a DVD list is being displayed, click the Utility Menu button at the bottom of screen and choose "Edit DVD List": You can re-set the DVD menu design, size of DVD disc and picture quality.

5 Write to a DVD.

You can check the video files in a DVD list. Select the video file you wish to check and click the Playback icon at the bottom of screen.

When checking the video files in list, click "Write" at the bottom of screen:



Note:

- If you load a written DVD-RW in the write drive, a dialog "Are you sure you want to delete the contents of disc?" will appear. Deleting the content of disc will erase all data on the disc: Carefully check the content of disc.
- If the disc contains a video file that does not conform to DVD-Video format, the video will be re-encoded, resulting in deterioration of image quality.

The screen for setting the write drive will appear. Choose the drive that you use to write to a DVD, and then click "Create": Writing to DVD will start.



If you wish to create multiple DVDs of the same contents, choose "Yes" for the message "Do you want to create another disc?" that will be displayed after a DVD is created.

Uninstalling Software

[When using Windows]

Use “Control Panel” to open “Add or Remove Applications”, choose the application to be uninstalled from the displayed list of applications, and then click the “Change/Remove” button.

Note:

- After uninstalling software, be sure to restart the PC.
- Administrator authority is required for uninstallation.

[When using Macintosh]

Manually move the following folders/files installed to Recycle Bin:

/Application/ImageMixer 3 for DVDCAM
/User/Movies/ImageMixer 3 for DVDCAM
/User/Library/Application Support/ImageMixer 3 for DVDCAM
/User/Library/Preferences/com.PIXELA.ImageMixer 3.DVDCAM.plist
/Library/Receipts/ImageMixer 3 for DVDCAM.pkg

Note:

- “User” will depend on the login user name.
- Administrator authority is required for uninstallation.

Cautions when connecting DVD video camera/recorder to PC

Use the AC adapter/charger to power the DVD video camera/recorder when connecting it to PC:

The DVD video camera/recorder can also use a battery, but if the DVD video camera/recorder cuts off during data transfer, important recordings will be lost: If data is being written to disc, the disc will then be unusable.

Do not unplug cables while the HDD/disc in DVD video camera/recorder is being accessed from PC:

If the PC connection cable (provided) or power cable is unplugged while the ACCESS/PC or CARD ACCESS indicator is blinking, important recordings will be lost: If data is being written to disc, the disc will then be unusable.

Before connecting the DVD video camera/recorder to PC, disconnect any cables other than the PC connection cable and AC adapter/charger.

Take care that the temperature of this DVD video camera/recorder is not too high when it is connected to PC: Use a reference of 30 minutes at approx. 30°C or less for operation.

If the temperature of the DVD video camera/recorder is too high, writing or reading on the DVD video camera/recorder may be faulty. And note that, if an error occurs during writing to a DVD-R, the disc will no longer be usable.

It will take some time to import a long-duration scene recorded on HDD into PC: During this time, make sure that the temperature of this DVD video camera/recorder does not get too high.

Contents edited on the DVD video camera/recorder will not be reflected in the provided software.

If the DVD video camera/recorder is connected via USB hub or to a USB port on PC front panel or keyboard, the DVD video camera/recorder may not be recognized by PC: If this happens, connect the DVD video camera/recorder to a USB port on PC rear panel.

If the DVD video camera/recorder power is off, it cannot be connected to PC.

Do not use PC application to finalize a DVD-RW/DVD-R recorded on this DVD video camera/recorder: Doing so will make the disc unusable.

Data may be readable or writable from/to the DVD video camera/recorder using software other than that provided with the DVD video camera/recorder, but Hitachi does not guarantee the operation.

If the PC is started from suspend (or sleep or standby) with the DVD video camera/recorder connected to the PC, the DVD video camera/recorder may not be recognized: Disconnect the DVD video camera/recorder from PC once, and restart the PC.

Multiple DVD video camera/recorders cannot be simultaneously connected to PC.

DVD discs created on the software provided with this DVD video camera/recorder can be played on DVD recorders/players, etc. that conform to each individual disc, but playback on all devices is not guaranteed. They may not be playable, depending on the playback device and/or disc recorded status.

Subsidiary Information

Introduction to Optional Accessories

CAMERA ACCESSORIES

Wide conversion lens (DZ-WL1)*¹ (p. 54)

Tele-conversion lens (DZ-TL1)*¹ (p. 54)

Step-up ring (DZ-SR3037) (p. 54)

- When using camera accessories, be sure to read the instruction manuals for each accessory.

*1 You will need the optional step-up ring when attaching these lenses.

POWER SUPPLY

Battery (DZ-BP7S)*²

Battery (DZ-BP14S)

Battery (DZ-BP21S)

*2 Unavailable for DZ-HS403.

- Refer to the catalog for details.
- The models and specifications of the optional accessories shown on this page are subject to change, and their production may be discontinued.

Trouble Messages

A message may appear while you are operating the DVD video camera/recorder. If a message appears, refer to the following table and take appropriate corrective action. Messages are arranged in alphabetical order.

Message	Cause & Troubleshooting	Reference page
(1) Data error in a part of image file. Repair data now? (2) Found error in image file. Repair data now? (3) Data error in all image file. Repair all data now?	<p>It is possible that the system cannot normally complete writing of file when power is turned off for some reason during recording or editing (deleting, dividing or combining scenes, or creating play list). Selecting "YES" will automatically repair the video file, but even if "NO" is selected, the same message will appear when the DVD video camera/recorder is turned on next time. (Do not remove the disc while the DVD video camera/recorder is recognizing it: Ignoring this will deactivate the file repair function.) Follow the instructions on screen, taking note of the following cautions:</p> <ul style="list-style-type: none"> • Be sure to use the AC adapter/charger to power the DVD video camera/recorder when repairing data: Repair is not possible using a battery. If a battery has been attached, turn the power switch off once, connect the AC adapter/charger, and then start repairing. • If message (1) appears when using the HDD, a battery can be used for repair (if the remaining battery level indicator shows more than half level). • Repair will normally be complete in several minutes, but it may take longer (up to one hour). • Data may not be repaired, depending on the timing when power was turned off. • Data may not be repaired normally if data recorded on another recorder is mixed in. • The repaired data may be different from the original recorded content because of partial deletion of defective portion. • Since the date/time for repair is added to the repaired data (only the corrected portion for partial repair), the original date/time information will be lost. • Since all movies, and then all stills, are repaired, the order of recorded contents will be lost in case of message (2) (3) only. • See *1 on page 148. 	—
(1) DVD is not formatted. Format the DVD now? (2) DVD Format. Select record format. (Displayed only when DVD-RW is used.)	A DVD-RW/+RW that was initialized by PC and not initialized for camera use is inserted.	41
All scenes are already dubbed. Please use other Dub Mode.	This message will appear if you attempt to execute "New" dubbing with no un-dubbed scenes on HDD. Turn off the dubbed marks on scene(s) you want to dub, or choose another dubbing method.	85, 88
Auto finalizing... Please wait...	This message will appear with a +RW when it is removed after recording, or the last recorded scene was deleted. The auto-finalized +RW can be played back on a DVD recorder/player.	118
Cannot combine scene.	Unless consecutive scenes are selected, they cannot be combined.	91

Message	Cause & Troubleshooting	Reference page
Cannot combine scene of multiple programs. Create PlayList first, and then combine scenes.	Scenes in different programs (different recording dates) cannot be combined. Create a Playlist first, and then combine such scenes on the playlist.	91
Cannot combine. Deselect PHOTO scenes.	Select only movies and combine them.	91
Cannot combine. Select multiple scenes.	Select a range of at least 2 scenes to be combined, and then combine them.	91
Cannot delete scenes.	This may occur when scene that was edited for division, etc. is to be deleted. Combine the divided scenes, and then delete them.	89, 91
Cannot divide scene.	This message will appear when the scene is extremely short because division, etc. was repeated.	90
Cannot execute. Change display category to ALL.	This message will appear if you attempt to combine or move scenes with "Category: VIDEO or PHOTO" specified.	114
Cannot execute. Unselect multiple scenes.	Division or change in thumbnail was executed when multiple scenes were selected.	79
Cannot finalize DVD in HDD mode. Please finalize DVD in DVD mode.	This message will appear if you press the FINALIZE button when the power switch is set to "HDD". Set the power switch to "DVD", and then finalize the disc.	112
Cannot read DVD. Check dirt/crack/both-sides contrary/inserted correctly.	Error occurred while the disc was being recognized. Make sure that there is no scratch or dirt on disc, that the surface/back of disc is not reversed, and that the disc is firmly pushed against the turntable. See *3 and *4 on page 148.	11, 40
CANNOT RECORD PHOTOS	<ul style="list-style-type: none"> This message will appear when the PHOTO/SELECT button is pressed with the power switch set to "HDD" or "DVD". No photo can be recorded on the HDD or disc in this DVD video camera/recorder: Use a card to record photos. 	33, 160
CANNOT RECORD VIDEO	This message will appear when the REC button is pressed with the power switch set to "SD".	33
Cannot replace thumbnail on PHOTO scenes.	The thumbnail of a still cannot be changed. Select a movie.	94
Cannot select any more scenes.	The maximum number of selectable scenes is 999.	97
CANNOT SLEEP MODE	<p>The DVD video camera/recorder can enter the sleep/restart status only from the recording pause status. The following conditions apply:</p> <ul style="list-style-type: none"> No DVD is loaded in this DVD video camera/recorder but the power switch is set to "DVD". No card is loaded in this DVD video camera/recorder but the power switch is set to "SD". The HDD, disc or card has no remaining space. The HDD/disc is protected. 	45
CARD ALMOST FULL	Remaining space is only enough to record less than 10 stills. Delete unnecessary stills and try the card, or use another card.	89, 110, 160

Message	Cause & Troubleshooting	Reference page
Card error has occurred.	<ul style="list-style-type: none"> The card terminals may be dirty: Wipe off dirt, and try the card again, or use another card. Data other than still image may be included: Use another card. 	27
Card error has occurred. Format the card now?	Was the card formatted on PC? Was formatting interrupted midway? When using the card on this DVD video camera/recorder, choose "YES" and format it.	109
Card error has occurred. Formatting is not complete.	The card may be damaged: Use another card.	27
Card error has occurred. Keep card inside & restart.	Card error could have occurred during editing of scenes. Turn off the DVD video camera/recorder with the card being used inside, connect the AC adapter/charger, and then power the DVD video camera/recorder again.	28, 33
Card full.	Delete unnecessary stills and try the card, or use another card.	89, 160
Card is not formatted. Format the card now?	Was the card formatted on PC? When using the card on this DVD video camera/recorder, choose "YES" and format it.	109
CHECK CARD	The inserted card cannot be used in this DVD video camera/recorder: Use another card.	27
CHECK DVD	A disc unusable on this DVD video camera/recorder may have been inserted or the disc may be damaged. Make sure that the type of disc is correct, and make sure that the disc is not write-protected.	27, 110
CHECK HDD	The HDD may have been destroyed. Also check to see whether the HDD is write-protected.	110
Control Information Error.	Mismatch may occur between the recorded image and scene information. Update the control information.	111
	<ul style="list-style-type: none"> Use another disc. See *3 and *4 on page 148. 	—
COPY PROTECTED	The video signal input to this DVD video camera/recorder may be copy-guarded. Some prerecorded video materials, such as movies, are guarded against copying. Copy-guarded materials cannot be recorded on this DVD video camera/recorder.	120
Dubbing is not complete.	This message will appear when dubbing has failed.	84, 88
DVD error has occurred. Finalizing is not complete.	<ul style="list-style-type: none"> Disc error occurred during finalizing, and finalizing failed. Replace the disc. See *3 on page 148. 	112
DVD error has occurred. Format the DVD now?	<ul style="list-style-type: none"> Has the disc been initialized on PC? Has initializing the disc on PC been interrupted? Choose "YES" and initialize the disc when using it on this DVD video camera/recorder. Initializing the disc will erase all data on it. See *2 on page 148. 	109
DVD error has occurred. Formatting is not complete.	The disc may be dirty. Remove the disc and wipe off fingerprints, dust, etc. before reusing it, or use another disc. This message may also appear if you insert a disc for which formatting was interrupted midway. In this case, use another disc.	11, 109

Message	Cause & Troubleshooting	Reference page
DVD error has occurred. Keep DVD inside & restart.	Disc error could have occurred during editing of scenes. Turn off the DVD video camera/recorder with the disc being used in it, connect AC adapter/charger, and then power the DVD video camera/recorder again. Repair of scenes will be tried.	28
DVD error has occurred. Please keep DVD inside and set power switch to "DVD".	This message will appear if disc error has occurred during dubbing. Connect the AC adapter/charger to DVD video camera/recorder, and set the power switch to "DVD": Video file will be repaired.	33
DVD error has occurred. Unfinalizing is not complete.	This message will appear when disc error occurred during unfinalization, and unfinalizing disc failed. Replace the disc.	113
DVD error has occurred.	<ul style="list-style-type: none"> Use another disc. See *3 and *4 on page 148. 	11, 26
	<ul style="list-style-type: none"> Mismatch in recording information may be caused by editing done on some device other than this DVD video camera/recorder. Initialize the disc or use another disc. Initializing the disc will erase all data on it. 	109
DVD full. Cannot execute.	This message will appear if the capacity of the scene selected is larger than the free space on disc. Select another scene, or use another DVD.	84
DVD must be finalized before it can be played back on DVD player or DVD recorder.	<ul style="list-style-type: none"> This message will appear if you remove a DVD-RW (VF-mode)/DVD-R that has not been finalized from the DVD video camera/recorder. See *5 on page 148. 	118
Drive overheats. Please retry later.	The temperature inside the DVD video camera/recorder is too high, and writing to disc or reading from disc may not be performed normally. Turn the DVD video camera/recorder off and wait for a while. The temperature will be effectively decreased if the DVD video camera/recorder is placed in a well-ventilated spot.	33
DVD-R* cannot dub the scene recorded in STD mode and 16:9.	With a DVD-RW (VF-mode)/DVD-R/+RW, no video can be recorded with a combination of movie quality "STD" and 16:9 mode "On". Replace the disc with a DVD-RAM or DVD-RW (VR-mode) for dubbing. * "DVD-RW (VF)" will appear when using a DVD-RW (VF-mode), "+RW" will appear when using a +RW.	84
DVD-R*, Different video mode, 16:9 and 4:3 mode cannot exist together.	With a DVD-RW (VF-mode)/DVD-R, the movie quality mode and 16:9 mode cannot be changed in the middle of disc: Change the movie to be dubbed or replace the disc with a DVD-RAM or DVD-RW (VR-mode). * "DVD-RW (VF)" will appear when using a DVD-RW (VF-mode).	66
DVD-R*, 16:9 mode cannot be changed, when Video mode is STD.	With DVD-RW (VF-mode)/DVD-R/+RW, the setting of 16:9 mode will not be possible when the Video mode is STD. * "DVD-RW (VF)" will appear when using a DVD-RW (VF-mode), "+RW" will appear when using a +RW.	66
DVD-R*, Input Source cannot be changed.	Once a DVD-RW (VF-mode)/DVD-R has been recorded in the 16:9 mode, the input source will not be changeable. * "DVD-RW (VF)" will appear when using a DVD-RW (VF-mode).	66
DVD-R*, Video mode and 16:9 mode cannot be changed.	With DVD-RW (VF-mode)/DVD-R, the movie quality mode and 16:9 mode once used for recording cannot be changed. * "DVD-RW (VF)" will appear when using a DVD-RW (VF-mode).	66

Message	Cause & Troubleshooting	Reference page
DVD-RAM, Finalize is not required.	This message will appear if you press the FINALIZE button with a DVD-RAM loaded in this DVD video camera/recorder. No finalization is necessary for a DVD-RAM.	112
END OF CARD	No more recording on this card can be done: Delete unnecessary stills or use another card.	89, 160
Error occurred. Please format HDD.	An error occurred with the HDD for which repair is being tried. Initialize the HDD: But note that initializing the HDD will delete all data stored on the HDD.	109
Error occurred. Please replace DVD or format DVD.	<ul style="list-style-type: none"> Abnormality has occurred with the DVD-RAM/DVD-RW/+RW to be repaired. Initialize the disc before using it, or use the another disc. Initializing the disc will erase all data on it. See *2 on page 148. 	109
Error occurred. Please replace DVD.	An abnormality occurred with a DVD-R to be repaired. Replace the disc.	—
Finalize may not be complete. Finalize again now?	This message will appear when power is supplied again and the disc is reinserted after power was shut off during finalization due to a power failure, etc. Choose "YES" if you wish to be sure finalizing is performed.	112
HDD/DVD ALMOST FULL	The remaining free space of HDD/disc is less than one minute for video: Delete unwanted scenes, or use another disc.	89, 159
HDD full. Cannot execute.	Delete unwanted scenes.	89
HDD/DVD has no data.	This message will appear when an attempt is made to execute dubbing, playback or editing on Disc Navigation when no scene has been recorded.	—
HDD/DVD has no PlayList.	Switching of play list was selected with no play list stored.	103
HDD/DVD includes protected scenes. Delete scenes?	The disc may be software protected from a device other than this DVD video camera/recorder. To release this case, use a device that has executed software-protect.	—
HDD/DVD is full. Cannot add control info.	The number of entered scenes has reached the limit that can be entered, so the control information for generating thumbnails cannot be added. Combine several scenes or delete them.	89, 91
HDD error has occurred.	Initialize the HDD before using the DVD video camera/recorder. Initializing the HDD will delete all data recorded on it.	109
HDD error has occurred.Format the HDD now?	Did you interrupt formatting the HDD? Choose "YES", and then format the HDD. Initializing the HDD will delete all data recorded on it.	109
HDD error has occurred.Formatting is not complete.	Did you interrupt formatting the HDD? Press the RESET button to execute system reset.	156
HDD error has occurred.Restart.	HDD error probably occurred during editing of video file. Turn off this DVD video camera/recorder, and then connect the AC adapter/charger to the DVD video camera/recorder to power it again: The video file will be repaired.	28

Message	Cause & Troubleshooting	Reference page
NO DVD	This message may appear when the DVD video camera/recorder or disc is moved from a cold place to a warm place. Condensation has occurred on the camera/recorder lens or HDD/DVD drive. Do not remove the disc; leave the DVD video camera/recorder turned off in a place as dry as possible for 1 – 2 hours.	7
	The disc has not been inserted. Insert it.	40
	The disc is not inserted correctly. Push the disc against the turntable at the center until a click is heard. See *3 and *4 on page 148.	40
	Is the disc surface/bottom reversed? Check the surface/bottom of disc, and reinsert it correctly.	40, 41
No more scenes. PlayList was deleted.	<ul style="list-style-type: none"> All scenes are deleted from the play list. Since a play list with no scenes cannot be supported by specifications, a play list from which all registered scenes have been deselected will be deleted. 	105, 106
PlayList over limit.	An attempt was made to create new play list or copy play list, even though limit specified for play lists in the video recording standard had already been stored.	102
Same scenes on Play List will be deleted. Delete scenes?	<ul style="list-style-type: none"> This will appear when scenes are to be deleted. When a play list exists on HDD or disc, an attempt to delete scenes in program will display this message. (This message will not appear if you deselect scenes from play list.) 	89
Scene No.xxx is too large. Please divide this scene before dubbing.	This message will appear during all scene dubbing if the data size of the scene to be dubbed is larger than the free space on one disc (approx. 1.4 GB, approx. 30 minutes in FINE mode). Divide the scene, and then dub it.	84
Scenes over limit. Cannot add scenes.	The number of scenes entered in play list has reached the limit that can be entered. Delete several scenes.	102, 106
Scenes over limit. Cannot divide scene.	The number of entered scenes has reached the limit that can be entered. Delete several scenes.	102, 106
Stop processing.	The  button was pressed to stop processing of multiple scenes.	—
There was no scene which can be deleted.	This message will appear if you try to delete multiple scenes on Disc Navigation when all the selected scenes have been locked. Release the lock on scenes before executing deletion.	89, 96
The scene from which Video mode/Wide mode differs cannot combine.	If the power switch is set to "HDD", scenes with different VIDEO Modes/16:9 modes cannot be combined.	91
The temperature of HDD is outside the operating temperature range. Please retry later.	This message will appear if the temperature of the HDD in this DVD video camera/recorder is outside the operating temperature range. Turn the DVD video camera/recorder off and wait for a while. The temperature will be effectively decreased if the DVD video camera/recorder is placed in a well-ventilated spot.	5, 158
The temperature of HDD is outside the operating temperature range. Turn off power.	This message will appear if the temperature of the HDD in this DVD video camera/recorder is outside the operating temperature range. Recording on a disc may be possible even if this message is displayed.	5, 158

Message	Cause & Troubleshooting	Reference page
This DVD cannot be used. Please replace DVD.	A disc that cannot be used on this DVD video camera/recorder has been loaded. Check the type of disc.	27
This DVD is finalized. Finalize is not required.	This message will appear if you press the FINALIZE button with a finalized DVD-RW/DVD-R/+RW loaded in this DVD video camera/recorder. Finalizing the disc is not necessary.	112
This DVD is recorded by the PAL system. Please replace DVD.	This DVD video camera/recorder can use only discs recorded on the NTSC system. A disc recorded on the PAL system cannot be used on this DVD video camera/recorder.	—
UNFORMAT DVD	The disc is not initialized or it is damaged. If this message appears, be sure to initialize the disc on this DVD video camera/recorder before using it. Reinitializing even a disc used on this DVD video camera/recorder may be necessary (initializing will erase all recorded contents on disc). If this message appears, try to initialize the disc. If the same message still appears, the disc may be damaged: Use another disc.	109
	See *2 on this page.	11
UNFORMAT HDD	The HDD may not be initialized, or it may be destroyed.	—
Use AC adapter/charger.	No dubbing, HDD deletion, or disc finalization is possible with a battery: Use the AC adapter/charger.	28, 84, 111, 112
Use AC adapter/charger. Turn off power.	Scene cannot be repaired when the DVD video camera/recorder is powered by a battery. If the AC adapter/charger is unavailable in handy place, remove the disc, use the opposite side, or use another disc. To repair the removed disc, insert the disc into the DVD video camera/recorder afterwards, and connect the AC adapter/charger.	28
Write protected. Check card.	A card with the erase prevention switch locked is inserted: Unlock the switch.	27
Write protected. Check HDD/DVD.	The HDD or disc is write-protected. Use the Disc Navigation menu to release the protection.	110

*1

- This message may also appear when dirt adheres to disc. If this message appears when a recorded disc is recognized immediately after it is inserted, do not repair the disc; remove it and then use the provided disc cleaning cloth to clean off the dirt before using it.
- This message may also appear when condensation occurs. In this case, do not repair the disc; turn the DVD video camera/recorder off, wait until it dries out, and then turn it on again.
- If the repair message appears when you turn the DVD video camera/recorder on from off with a disc loaded after recording on it, choose repair.
- If the repair message appears when recording and playback are normally possible with another disc – and no condensation occurs and the disc is not dirty – choose repair.

*2

- This message may also appear when dirt adheres to disc. In this case, do not initialize the disc: Remove it and then use the provided disc cleaning cloth to clean off the dirt before using it.
- This message may also appear when condensation occurs. In this case, do not initialize the disc; turn the DVD video camera/recorder off, wait until it dries out, and then turn it on again.
- Initialization will delete all data on disc.

*3

- This message may also appear when dirt adheres to disc. Remove the disc and then use the provided disc cleaning cloth to clean off the dirt before using it.
- This message may also appear when condensation occurs. Wait until the DVD video camera/recorder dries out, and then turn it on again.

*4

- This message will appear when a single-sided disc is inserted in reverse. Reinsert the disc correctly. (Insert the disc with the label printed surface facing the outside.)

*5

- Do not insert a DVD-RW (VF-mode)/DVD-R that has not been finalized into any DVD recorder: The disc may be unusable.

Troubleshooting

Check to see the following before asking for a repair. If the suggested solution still cannot restore the DVD video camera/recorder to normal, do not attempt to repair it yourself, but consult your dealer.

Power supplies

Symptom	Cause and Correction	Reference page
Battery cannot be charged.	Is the ambient temperature too low or too high? Charge the battery at 10 – 30°C.	29
	Is the battery abnormally hot? Remove the battery, leave it for a while to cool down, then charge it.	
	Is the DC power cord connected to AC adapter/charger? Unplug it.	
	Has the battery been unused for a long time? Remove the battery, and then reattach it. • If the battery does not charge after you try the above four procedures, it may be dead: Purchase a new battery.	
Battery weakens fast.	Are you using the DVD video camera/recorder where the temperature is low? A fully charged battery (DZ-BP14S/DZ-BP14SJ/DZ-BP7SJ/DZ-BP21SJ) may be discharged sooner than usual at low temperatures. Keep extra batteries on hand.	31
	Battery may be dead. The performance of battery will deteriorate if it is used for an extended period of time or frequently: Purchase a new battery.	32
The CHARGE indicator on AC adapter/charger is blinking.	Is the ambient temperature too low or too high? Charge the battery in environment where the temperature is 10 – 30°C. The battery has possibly discharged excessively. Continue charging: After a while, the battery will be charged to the specified voltage, and the CHARGE indicator will light. Then the battery charge will be completed normally.	29, 30
Power turns off immediately after being turned on.	Is battery charged? Charge it.	29
When power is turned on, the LCD screen will turn on and off.		
The ACCESS/PC indicator is blinking, even though nothing is displayed on LCD monitor screen.		
Power goes off unexpectedly.	Is Power Save set to “On”? If the powered DVD video camera/recorder is left for as long as 5 minutes without recording or playback with “Power Save: On” specified, it will automatically turn off to save battery power. To restart recording in this case, set the power switch to “OFF” and then set it to “HDD”, “DVD” or “SD”. You can also specify “Power Save: Off” to stop automatic power off.	36
	Is the DVD video camera/recorder set to the sleep/restart status? If 30 minutes or more has elapsed with the DVD video camera/recorder in the sleep/restart status, it will automatically turn off. Set the power switch to “OFF”, and then power the DVD video camera/recorder again.	45

Symptom	Cause and Correction	Reference page
Power cannot be turned off.	Detach the battery or AC adapter/charger once, and then press the RESET button of DVD video camera/recorder: Reattach a power supply to DVD video camera/recorder before turning it on again.	28, 30, 156
Even if the DVD video camera/recorder is off, opening the cover will cause the ACCESS/PC indicator to blink.	The DVD video camera/recorder will automatically turn on to recognize a disc: Closing the cover will automatically turn the DVD video camera/recorder off.	41

During recording

Symptom	Cause and Correction	Reference page
Pressing the REC button will not start recording.	<ul style="list-style-type: none"> • Check to see whether the proper type of DVD is loaded. • Set the power switch to "HDD" or "DVD". • If the input image is copy-guarded, it cannot be recorded. • If HDD/DVD is protected, end protection. • No recording can be done on a finalized DVD. • Check the remaining free space on HDD/DVD. • If, when using a +RW, one-time recording duration is short or you frequently switch the video quality, recording may not be possible even when the disc has remaining space. 	26, 33, 110, 112, 120
Recording starts but stops immediately.	Is disc scratched or does dirt or fingerprint adhere to it? Clean the disc. If there is still no improvement, replace the disc.	11
	Is some other AV device directly connected to the video/audio input/output jack of this DVD video camera/recorder? If the AV device is connected via several other devices, such as AV selector, the video signal may not be transmitted incorrectly. In such a case, reduce the number of devices through which the video signal is transmitted, or connect AV device directly.	119
	Are you attempting to record image from video game or PC? From some video games or PCs, image cannot be recorded on this DVD video camera/recorder.	—
No photo can be recorded	<ul style="list-style-type: none"> • Check to see whether the proper type of card is loaded. • Set the power switch to "SD". • If the card is locked, unlock it. • Check the remaining free space on card. 	27, 33, 110
LCD screen is hard to see.	Has brightness of LCD screen been adjusted? Stop recording and adjust the brightness.	38
	Is the DVD video camera/recorder being used outdoors? Use the viewfinder. When using LCD monitor, adjust its angle so that LCD screen is not exposed to direct sunlight.	34
Unevenness appears on LCD monitor screen.	Did you press the LCD monitor or the area around it? If the LCD monitor is pressed, some unevenness will occur. Release your hand and leave the LCD monitor for a while: Normal display will be restored.	—

Symptom	Cause and Correction	Reference page
Focus is not correct.	Is it difficult to use auto focus with your subject? Focus manually.	56
	Does manual focus icon appear? The DVD video camera/recorder is set to manual focus. Focus the subject manually, or release manual focus.	55
	Is the diopter control correctly adjusted if you are using the viewfinder as a monitor? Adjust the diopter control.	34
	In cases other than the above, set the power switch to "OFF", and then set it to "HDD", "DVD" or "SD" again.	33
An error message for repair appears.	Perform repair following the instructions on screen. Repair is possible when the DVD video camera/recorder is powered by the AC adapter/charger. If you are using the HDD and have detected an error in part of video file, a battery can also be used for repair (if the remaining battery level indicator shows more than half level). It will take from a few minutes to several hours for repair. If you wish to start recording immediately, remove the disc, and then insert another disc: The removed disc can later be repaired by connecting the AC adapter/charger.	28

During playback

Symptom	Cause and Correction	Reference page
Recognition of disc is not complete.	Is disc dirty? Use the provided disc cleaning cloth to clean it.	11
Pressing the playback button will not start playback.	Has the image been recorded by devices other than this DVD video camera/recorder? Playback of image recorded on devices other than this DVD video camera/recorder may be impossible on this DVD video camera/recorder.	74
	Has scene been edited on a device other than this DVD video camera/recorder? If a scene recorded on this DVD video camera/recorder is edited on a device other than this DVD video camera/recorder, playback may not be possible on this DVD video camera/recorder.	
No playback picture appears on TV screen.	Is TV input selector set correctly? Some TVs have multiple video input jacks. Check whether the correct input was selected on TV to match the connected jacks. If the DVD video camera/recorder is connected to VCR, set its input selector to "external input (LINE)".	117
	Is the DVD video camera/recorder connected to TV correctly? Check the connections.	116
Playback picture is momentarily interrupted.	Is disc scratched or does dirt or fingerprint adhere to it? Clean the disc.	11
Poor playback picture.	Was the image input from analog VCR (VHS, 8 mm) and recorded? The problem may be improved if a VCR equipped with TBC circuit is used for playback.	—
Playback picture is greatly distorted.	Was recording of external input made with "Frame" specified? Specify "Field" for "PHOTO Input" in record functions setup.	68

Symptom	Cause and Correction	Reference page
No sound.	Is the TV volume control set correctly? Adjust TV volume control, and be sure to adjust the volume on TV.	117
Disc Navigation thumbnails do not appear.	Was the image recorded from AV input/output jack with interference? Record image with no noise or disturbance.	—
Photos on card cannot be played back.	<p>This DVD video camera/recorder can play back image data recorded on SD memory card in other digital cameras conforming to the DCF (Design rule for Camera File system) standard. The range of image data normally playable on this DVD video camera/recorder is that with pixels from 80 horizontal × 60 vertical to 4000 horizontal × 3000 vertical. If the pixel data is outside this range, blue thumbnails will appear (thumbnails* in the figure), meaning the image is unplayable.</p>  <p style="text-align: center;">* Fig. 1</p> <p>Even when the number of pixels is within the above range, playback may not be possible, depending on the recording status of the digital cameras used. DCF (Design rule for Camera File system) is an integrated image file format of digital cameras: Image files can be used on all digital devices conforming to DCF.</p>	—
It will take some time to play back photos on card.	When playing back a still, "Playback." will appear: Stills with a large number of pixels will take some time to appear.	—

When the DVD video camera/recorder is connected to PC

Symptom	Cause and Correction	Reference page
No drive icon appears on PC.	The DVD video camera/recorder is not turned on. Check the power supply.	33
	Turn PC off and then disconnect the PC connection cable. Turn PC on again, and then use the PC connection cable to connect the DVD video camera/recorder to PC.	—
	Make sure the PC connection cable is completely plugged into this DVD video camera/recorder.	—
Error occurs in playback of DVD video camera/recorder on PC.	If error occurs with USB connection, the transfer rate is not sufficient. It is recommended that you use a USB terminal conforming to USB2.0 when connecting the DVD video camera/recorder.	123
Application is not normally run on PC.	Turn the PC and DVD video camera/recorder off, and try again.	—

Symptom	Cause and Correction	Reference page
Error occurs during writing to disc.	The temperature of DVD video camera/recorder is too high due to continuous operation. Disconnect the DVD video camera/recorder from PC once, remove the disc from the DVD video camera/recorder, and then turn it off. After a few moments, connect them again and write to a brand-new disc.	—
Transfer of images stops.	Connect the DVD video camera/recorder to another USB terminal of PC. If your PC is a desktop type, it is recommended that you use USB terminal on the back of PC. If you are using USB2.0 extended card, it is also recommended that you install the newest version driver provided by each USB2.0 card maker.	—
	Is disc scratched or does dirt or fingerprint adhere to it? Clean the disc.	11
DVD drive built into PC cannot be used after the provided software has been installed.	This problem may be solved if you update the DVD editing/creating software of your PC.	—
Error appears when starting ImageMixer 3.	Make sure that your PC display adapter (video card) conforms to DirectX®9.0c.	123
Movies are not recognized by application in PC.	Make sure the power switch of this DVD video camera/recorder is set to “HDD” or “DVD”.	33
The DISC EJECT button is not valid when the DVD video camera/recorder is connected to PC.	While the DVD video camera/recorder is connected to PC, use Explorer to right-click the DVD video camera/recorder drive icon and execute “Eject”.	128
No sound is heard when an MPEG file imported into Macintosh is played back on Quick Time with an MPEG 2 playback component adopted.	Since an MPEG file imported into Macintosh using ImageMixer 3 Mac Edition for DVDCAM uses the audio format of AC3 audio, no audio will be played back even if the Quick Time MPEG-2 playback component is introduced: Only video will be played back. Use ImageMixer 3 Mac Edition for DVDCAM for playback.	135
When the time stamp of file in DVD-RAM is viewed on PC, it is different from the actual recording time.	The file system of this DVD video camera/recorder is operated on Greenwich Mean Time (GMT), and time lag information has not been set. With Windows® as of September, 2007, the time stamp of file viewed on Explorer looks different from the actual recording time. The actual recording time will appear for date/time indication on playback screen.	—
It will take some time to save a video edited on the video editor of ImageMixer 3.	If you are editing a video file whose contents are different from those of project setting, it may take some time, since the entire video file must be re-encoded. Reconfirm the project setting.	—
“Hardware Removal” results in error.	Exit Windows® once, and then disconnect the DVD video camera/recorder. If your PC uses Windows® 2000 Professional, the problem may be solved if you install Windows® 2000 SP3 or later.	130
No USB HS (high speed) connection even when USB2.0 card is used.	Make sure that you have already installed the driver provided with the USB2.0 card. You will need to install the driver provided by USB2.0 card maker in order to operate the USB2.0 card at HS (high speed).	—

Miscellaneous

Symptom	Cause and Correction	Reference page
No DVD video camera/recorder operation.	Is a fully charged battery attached? Is the DVD video camera/recorder powered from AC outlet?	28, 29
Power does not come on, or no operation occurs by pressing button.	Execute system reset (press the RESET button).	156
	Has the DVD video camera/recorder been subjected to impact? The DVD video camera/recorder could be damaged. Consult your dealer.	—
The date and time are incorrect.	Has the DVD video camera/recorder been left unused for a long period of time? The internal backup memory battery may be discharged: Charge it.	36
Pressing the SLEEP/RESTART button will not set to the sleep/restart standby status.	<ul style="list-style-type: none"> • Is the proper disc or card loaded? • Does the HDD, disc or card have remaining free space? • Is the DVD video camera/recorder now playing back? • Is Disc Navigation screen displayed? 	45
No scene can be deleted.	Is the cursor placed on the scene to be deleted? If the selected scene (framed in red) exists, that scene will be deleted even if you use yellow cursor to select any scene. Check the colors of cursors and bar graph on the thumbnail screen.	79, 89
Disc cannot be removed. (Cover will not open.)	Did you detach the battery or AC adapter/charger before setting the power switch to "OFF"? Is the battery charged? Connect a charged battery or the AC adapter/charger, and then press the DISC EJECT button to remove the disc. Did the DVD video camera/recorder turn off because the battery remaining level ran out? Connect a charged battery or the AC adapter/charger, set the power switch to "OFF", and then press the DISC EJECT button to remove the disc. Is the power switch set to "HDD" or "SD"? Set the power switch to "DVD" or "OFF", and then press the DISC EJECT button.	28, 29, 33
DVD video camera/recorder cannot be operated from remote control.	Is the remote control pointed at the infrared receiver on DVD video camera/recorder? Point it at the infrared receiver to operate the DVD video camera/recorder.	24
	Is the infrared receiver on DVD video camera/recorder exposed to direct sunlight or strong fluorescent light, etc.? The remote control cannot operate the DVD video camera/recorder when strong light strikes the infrared receiver. Adjust the place or angle of the DVD video camera/recorder.	24
	Is there battery in the remote control? Also check the polarities of battery. The battery could be dead: Try replacing it.	23
	Is the DVD video camera/recorder powered? Turn it on.	33

Symptom	Cause and Correction	Reference page
Disc cover cannot be closed.	Is disc correctly inserted? Was disc inserted from wrong direction? Remove the disc and then reinsert it.	40
	Connect a fully charged battery or AC adapter/charger, and then turn the DVD video camera/recorder on.	28, 30
Operating sound is heard cyclically.	This sound is heard because the disc is cyclically operated and does not indicate a fault.	—
Some vibrations are felt or slight sound is heard from mechanism.	These vibrations or sound are caused by HDD/disc drive: This does not indicate a fault.	—
<ul style="list-style-type: none"> • No operation can be performed because the ACCESS/PC or CARD ACCESS indicator on this DVD video camera/recorder remains lit or blinking. • After disc or card is inserted, it takes some time until recording is possible. 	In the following cases, it will take more time than usual until operation is possible: <ul style="list-style-type: none"> • Immediately after a disc or card is reinserted. • When a long time has elapsed since the DVD video camera/recorder was turned off last. • When the temperature is greatly different from the status of previous recording. • When disc with scratches, dirt or fingerprints is inserted. • When disc is subject to severe vibrations. • When the battery or DC power cord was disconnected instead of following the correct procedure using power switch to turn the DVD video camera/recorder off. 	8, 40
No image in viewfinder.	<ul style="list-style-type: none"> • Is LCD monitor open? No image will appear in viewfinder unless the LCD monitor is closed and securely locked to DVD video camera/recorder. • Is the DVD video camera/recorder set to the sleep/restart status? Press the SLEEP/RESTART button to release the sleep/restart status. 	34, 45
No image appears on the LCD screen or in the viewfinder.	<ul style="list-style-type: none"> • Is DVD video camera/recorder connected to PC using PC connection cable? Unplug the PC connection cable. • Does DVD video camera/recorder stop at the end of the scene to which wipe-out was set and played back? Press the DISC NAVIGATION button. • Is the DVD video camera/recorder set to the sleep/restart status? Press the SLEEP/RESTART button to release the sleep/restart status. 	45, 92, 127

System Reset

If the DVD video camera/recorder does not operate normally, perform "System Reset". The DVD video camera/recorder may recover to normal. "System Reset" will reset all settings to factory defaults. The date and time will also be reset: Set the date and time again before using the DVD video camera/recorder.

- 1 Set the power switch to "OFF" to turn the DVD video camera/recorder off.
Detach the battery or AC adapter/charger.
- 2 Use a fine tipped pen to hold down the reset button for several seconds.

All settings will be reset.

Note:

- Do not press the RESET button with undue force.
- Before pressing the RESET button, be sure to remove the disc from the DVD video camera/recorder: Pressing the RESET button with a disc loaded may erase the scenes recorded on the disc.

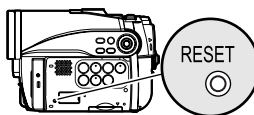

● List of setting items

	Item	Default	Setting method
Camera Functions Setup	Program AE	Auto	p. 60
	White Bal.	Auto	p. 61
	EIS	On	p. 63
	Dig.Zoom	40x ^{*1}	p. 53
	MIC.Filter	Off	p. 63
	Flash ^{*2}	Auto	p. 58
Record Functions Setup	VIDEO Mode	FINE	p. 64
	Quality	FINE	p. 67
	16:9	On	p. 65
	Input Source	CAMERA	p. 67
	PHOTO Input	Field	p. 68
	Self Timer	Off	p. 68
	OSD Output	On	p. 69
	HDD protection	On	p. 69
Date Setup	Date Set	2007/1/1 AM0:00	p. 35
	Date Mode	Y/M/D	p. 36
LCD/EVF Setup	LCD Brightness		p. 38
	EVF Brightness		p. 38
	Color Level		p. 39
	EVF Display	Auto	p. 39

	Item	Default	Setting method
Initial Setup	Beep	On	p. 36
	Power Save	Off	p. 36
	Record LED	On	p. 37
	Language	日本語 (Japanese)	p. 35
	Demo Mode	Auto	p. 37

*1“60x” will appear on DZ-HS401.

*2Not displayed on DZ-HS401.

- Some items will not appear depending on the disc or card inserted.

Major Specifications

CCD	DZ-HS403: 1/3-inch interlaced DZ-HS401: 1/5-inch interlaced Total number of pixels DZ-HS403 approx. 3,310,000 DZ-HS401 approx. 1,330,000 Number of effective pixels DZ-HS403 Movie: approx. 2,180,000 Movie: approx. 1,640,000 (in wide mode) Still: approx. 3,050,000 DZ-HS401 Movie: approx. 690,000 Still: approx. 1,100,000
Lens	DZ-HS403: F1.8 – 3.0 f = 6.1 – 61 mm Filter diameter: 37 mm Thread pitch: 0.75 mm DZ-HS401: F1.2 – 2.8 f = 3.0 – 45 mm Filter diameter: 30.5 mm Thread pitch: 0.5 mm
Focus	Auto/Manual
Zoom	Optical 10× (DZ-HS403), Optical 15× (DZ-HS401), 40× – 240× (DZ-HS403), 60×–500× (DZ-HS401) with digital zoom added, 40× (DZ-HS403), 60× (DZ-HS401) for still
Required minimum illumination	24 lx in Auto mode (1/30) 1 lx in Low Light mode (1/4)
Viewfinder	0.2-inch color TFT (equivalent to approx. 200,000 pixels)
LCD monitor	2.7-inch color TFT (approx. 120,000 pixels)
Electronic image stabilizer	Electronic type
Shutter speed	1/4 – 1/4000 seconds (movie)
Self-timer recording	Still recording only
External microphone jack	ø3.5 mm stereo mini-jack (a plug-in power type microphone cannot be used)

Capacity of built-in HDD		Approx. 8 GB
Recording mode		Movie (with sound) Still (with SD memory card)
Maximum recordable time	HDD	Approx. 110 minutes (XTRA) Approx. 180 minutes (FINE) Approx. 360 minutes (STD)
	DVD-RAM/DVD-RW/ DVD-R/+RW (per side)	Approx. 18 minutes (XTRA) Approx. 30 minutes (FINE) Approx. 60 minutes (STD)
Maximum number of recordable stills	SD memory card (when using 32 MB card)	DZ-HS403 approx. 18 (in FINE mode) DZ-HS401 approx. 45 (in FINE mode) External input approx. 180 (in FINE mode) Varies depending on the recording quality and the type of card (p. 160).
Recording format	DVD-RAM/DVD-RW (VR-mode)	Movie: Conforming to DVD video recording (DVD-VR) format (Dolby Digital)
	DVD-RW (VF-mode)/ DVD-R	Movie: Conforming to DVD video format (Dolby Digital)
	+RW	Movie: DVD+RW video format (Dolby Digital)
	Card	Still: Conforming to JPEG (DZ-HS403: 2,016×1,512 pixels, DZ-HS401: 1,280×960 pixels, External input: 640 × 480 pixels) standard
Audio playback format		MPEG Audio layer 2, linear PCM, Dolby Digital
Recordable discs		8 cm DVD-RAM (conforming to DVD-RAM Ver. 2.1) 8 cm DVD-RW (conforming to DVD-RW Ver. 1.1, 2x speed [2x/1x]) 8 cm DVD-R (conforming to DVD-R for General Ver. 2.0) 8 cm +RW (conforming to +RW Ver. 1.2) Only discs not packed in Round DVD Holder or cartridge.
Recordable card		SD memory card
Jacks		Video/audio input/output × 1 External microphone input ×1 PC connection terminal (connected to PC USB port) ×1
Battery system		Lithium-ion
Power consumption		When recording with LCD monitor off (DVD-RAM used) DZ-HS403 approx. 5.1W (in FINE mode) DZ-HS401 approx. 3.8W (in FINE mode)
Dimensions (W × H × D)		DZ-HS403: approx. 66 × 92 × 143 mm (including supplied battery pack, excluding hand strap) DZ-HS401: approx. 61 × 87 × 133 mm (including supplied battery pack, excluding hand strap)
Operating temperature (humidity)		0 – 40°C (less than 80%) 0 – 30°C when connected to PC
Storage temperature		-20 – 60°C
Allowable operating altitude (when using HDD)		3000 m or less
Weight		DZ-HS403 approx. 485 g (without battery or disc) DZ-HS401 approx. 435 g (without battery or disc)

Total weight when recording	DZ-HS403 approx. 560 g (When using the battery pack DZ-BP14S) DZ-HS401 approx. 510 g (When using the battery pack DZ-BP14S)
Provided accessories	AC adapter/charger, Battery, AV/S input/output cable, Infrared remote control, Lithium battery for remote control, Lens cap, Lens cap string, Shoulder strap, Power cable, DC power cord, Software CD-ROM, PC connection cable, Disc cleaning cloth

STORAGE CAPACITY OF HDD/DVD/CARD

Recordable Time On HDD*1

Recording quality	Movie recordable time	Application
XTRA	Approx. 110 min *1	Best quality
FINE	Approx. 180 min *2	High quality
STD	Approx. 360 min *3	Standard quality

Recordable Time On Disc

Movie recordable time on one disc (on single side) (when recording only movies)

Recording quality	Movie recordable time	Application
XTRA	Approx. 18 min *1	Best quality
FINE	Approx. 30 min *2	High quality
STD	Approx. 60 min *3	Standard quality

*1: Variable bit recording (recording of more than 110 minutes on HDD or more than 18 minutes on disc may be possible because the transfer rate varies automatically between approx. 3 - 10 Mbps)

*2: Fixed bit rate: Approx. 6 Mbps

*3: Fixed bit rate: Approx. 3 Mbps

Note:

- If you record in XTRA mode at high temperatures, the DVD video camera/recorder will heat up and the maximum transfer rate will be limited to approx. 6 Mbps, so the best quality will not be obtainable.

Maximum Number of Scenes that Can Be Recorded/Dubbed on HDD/One Disc

Recording media	Maximum number of scenes
HDD*1	999
DVD-RAM/DVD-RW*2	999
DVD-R*2	930
+RW*2	254

*1: Recording only

*2: Per disc (one side)

Maximum Number of Programs that Can Be Recorded/Dubbed on HDD/One Disc

Recording media	Maximum number of programs
HDD*1	99
DVD-RAM/DVD-RW*2	99
+RW*2	49

*1: Recording only

*2: Per disc (one side)

RECORDABLE STILLS (PHOTOS) ON CARD

For DZ-HS403

Recording quality	Capacity					
	32 MB	64 MB	128MB	256 MB	512 MB	1 GB
FINE	Approx. 18	Approx. 38	Approx. 75	Approx. 150	Approx. 300	Approx. 600
NORM	Approx. 24	Approx. 50	Approx. 100	Approx. 200	Approx. 400	Approx. 800
ECO	Approx. 37	Approx. 75	Approx. 150	Approx. 300	Approx. 600	Approx. 1,200

For DZ-HS401

Recording quality	Capacity					
	32 MB	64 MB	128MB	256 MB	512 MB	1 GB
FINE	Approx. 45	Approx. 95	Approx. 190	Approx. 380	Approx. 750	Approx. 1,500
NORM	Approx. 60	Approx. 120	Approx. 250	Approx. 500	Approx. 1,000	Approx. 2,000
ECO	Approx. 90	Approx. 190	Approx. 380	Approx. 760	Approx. 1,500	Approx. 3,000

With external input

Recording quality	Capacity					
	32 MB	64 MB	128MB	256 MB	512 MB	1 GB
FINE	Approx. 180	Approx. 380	Approx. 750	Approx. 1,500	Approx. 3,000	Approx. 6,000
NORM	Approx. 240	Approx. 500	Approx. 1,000	Approx. 2,000	Approx. 4,000	Approx. 8,000
ECO	Approx. 370	Approx. 750	Approx. 1,500	Approx. 3,000	Approx. 6,000	Approx. 12,000

(The numbers of recordable stills above are only for reference)

Size And Quality Of Photos

The following table shows the file size and quality of one still (JPEG) recorded on card:

Quality	File size			Application
	DZ-HS403	DZ-HS401	External input	
FINE	Approx. 1,600 KB	Approx. 640 KB	Approx. 160 KB	When image quality is prioritized
NORM	Approx. 1,200 KB	Approx. 480 KB	Approx. 120 KB	Standard quality
ECO	Approx. 800 KB	Approx. 320 KB	Approx. 80 KB	When number of stills is prioritized (quality will be slightly inferior)

The quality mode can be chosen when recording stills on card (p. 67).

Note:

- No still can be recorded on HDD/DVD.

Index

Numerics

16:9	65
8 cm bare disc	26

A

AC adapter/charger	28
ACCESS/PC indicator	43
Add (edit)	105
All programs	99
Auto (program AE)	60
Autofocus	55
AV input/output jack	116

B

Backlight correction	57
Battery	
Attaching to DVD video camera/recorder	30
Charging	29
Recordable time on DVD video camera/ recorder	31
Removing from DVD video camera/ recorder	30
Setting Up	29
BATTERY EJECT button	30
Black & White fade	92
Brightness	38

C

Camera Functions Setup	52
Capacity	110
Card	
Available	27
Capacity	110, 160
Format	109
Handling	27
Quality	67
Category	114
CHARGE indicator	29
Cleaning	10
Color Level	39
Connecting to TV	116
Copy	95
Create	102

D

Date and time	35
Date setup	35
Defaults	37
Delete (edit)	106
Delete (play list)	108
Delete (scene)	89, 105
Detail (scene)	98
Dig. Zoom	53
Diopter control	34
Disc	
Available	26
Finalize	112
Format	109
Handling	10
Protection	110

Update Control Info.	111
DISC EJECT button	40
Display	
Information LCD	46
Scenes information	98
Viewfinder	34
Divide	90
Dubbing	
Dubbed mark	85
Dubbing from HDD to disc	87
Dubbing from/to other video devices	119
Dubbing Menu	85
DUBBING button	85
DVD player	118
DVD-R	26
DVD-RAM	26
DVD recorder	118
DVD-RW	26

E

Edit (play List)	104
EIS	63
EXPOSURE button	57
Exposure control	57
External microphone jack	70

F

Fade	92
FIELD (PHOTO Input)	68
FINALIZE button	112
Finalize DVD	112
FINE (VIDEO Mode)	64
FOCUS button	55
Format	109
FRAME (PHOTO Input)	68
Frame advance/Frame back	75
Full Auto	59
FULL AUTO button	59
Full Menu	51

G

Go To (during playback)	77
Go To (on Disc Navigation)	109

H

Hand strap	22
HDD	
Format	109
Protection	110
Howling	116

I

Information display mode	46
Infrared receiver	24
Initial Setup	36
Input Source	67

L

Language	35
Laser pickup block	40

LCD monitor light	61
Lens cap	23
Lens cap string attachment hole	23
Linear PCM	158
Lock	96
LOCK switch	43
Low Light (Program AE)	61

M

Manual Focus	55
MENU button	51
MIC.Filter	63
Move	107

O

Optical 10x zoom lens	53
Optical 15x zoom lens	53
OSD Output	69

P

PHOTO capture	75
PHOTO Input	68
PHOTO/SELECT button	44, 79
Play (play list)	103
Play (program)	100
Play list	102
Add scenes	104
Add scenes (submenu)	105
Create	102
Delete	108
Delete scenes	105
Delete scenes (submenu)	106
Move	107
Play	103
Select	103
Select scenes (submenu)	106
Title	108
Portrait (Program AE)	60
Power Save	36
Power switch	33
Program	99
Play	100
Select	99
Title	100
Program AE	60
Protect	110

Q

Quality (Card)	67
Quick Menu	51
QUICK MENU button	51

R

Record button	43
Recording indicator	37
Remote control	23
Repeat Play	115
Reset	
settings	37
system	156
RESET button	156
+RW	26

S

Sand & Snow (Program AE)	60
Scene	72
Combine	91
Delete	89
Detail	98
Divide	90
Fade	92
Move	91, 107
Select	97
Skip	93
Searching for image	75
Select (play list)	103
Select (program)	99
Select (Scene)	79
Self Timer	68
Shoulder Strap	22
Skip (Scene)	93
Skip playback	76
Slide Show	115
Sports (Program AE)	60
Spotlight (Program AE)	60
STD (VIDEO Mode)	64
Submenu	90

T

Tele-conversion lens	54
Thumbnail	72
Title (play list)	108
Title (program)	100
TV type	115

U

Update Control Info.	111
---------------------------	-----

V

Video Flash	58
VIDEO Mode	64
FINE	64
STD	64
XTRA	64
Video selector	66, 120
Volume	73

W

White Bal.	61
White fade	92
Wide conversion lens	54
Wipe fade	92

X

XTRA (VIDEO Mode)	64
-------------------------	----

Z

Zoom lever	53, 73
------------------	--------

Be sure to read the following before opening the package of CD-ROM

This Agreement will take effect at the moment you open the package of the storage device (CD-ROM) provided with this product, if you agree to the terms herein.

If you do not accept the terms of this Agreement, immediately return the unopened package of storage medium and enclosed materials (printed matter, external package, and all others) to your dealer, or return only the package of storage medium to your dealer.

Consult your dealer for any refund on the unused product. However, if only the package of storage medium is returned, no refund is possible.

This License Agreement certifies that you were granted license in the past.

License Agreement

■ Grant of License

- Hitachi, Ltd. nonexclusively grants you the right to install this program in one computer and use it, but this right cannot be transferred to a third party.
- You can duplicate one copy of this program in a form readable on computer, but only for the purpose of backup, and under the condition that the display concerning the copyright remains in the original status.

■ Prohibition

- This program may not be used on network. If you wish to use it for multiple computers on network, you must obtain the right of use for each computer from Pixela Corporation.
- You may not let any third party use this program by granting reuse, transfer, lease, lending, etc.
- You may not modify, alter, decompile or disassemble all, or any part, of this program or its accessories. And you may not allow any third party do so.

■ Termination of Agreement

If you duplicate this program and its accessories without permission, or fail to comply with the above granting conditions, this agreement will automatically be terminated. In addition, Pixela Corporation may take legal action. When the agreement is terminated, you will be obliged to discard this program, its accessories and all duplicates, or return them to Pixela Corporation.

■ Guarantee and Immunity

This program and its accessories shall not, explicitly or implicitly, conform to the merchantability or compatibility for your specific purpose of use. Pixela Corporation does not guarantee that the functions of this program will meet your needs or this program will be free from interruption or error during its operation.

Under no circumstances will Pixela Corporation accept any responsibility for any direct or indirect losses or damages you may incur from using this program or activities relating to its use, or for any conflict occurring between you and a third party originating from, or relevant to, use of this program.