



GE E850 Digital Camera



Getting ready

Basic operation

Using the modes

Playback

Using the menus

Connections

Appendices

WARNING

To prevent fire or shock hazard, do not expose the unit to rain or moisture.

For customers in the U.S.A.

**Tested To Comply
With FCC Standards
FOR HOME OR OFFICE USE**

FCC Statement

This device complies with part 15 of the FCC Rules.

Operation is subject to the following two conditions:

(1) This device may not cause harmful interference, and (2) this device must accept any interference received, including interference that may cause undesired operation.

For customers in Europe



"CE" mark indicates that this product complies with the European requirements

for safety, health, environment and customer protection. "CE" mark cameras are intended for sales in Europe.



This symbol [crossed-out wheeled bin WEEE Annex IV] indicates separate collection of waste electrical and electronic equipment in the EU countries. Please do not throw the equipment into the domestic refuse. Please use the return and collection systems available in your country for the disposal of this product.

Declaration of Conformity

Model Name : E850
Trade Name : GE
Responsible Party : General Imaging Co.
Address : 2158 W.190th Street,
Torrance, CA 90504, USA
Telephone Number : 1-800-730-6597

Conforms to the following Standards:

EMC: EN 55022:1998/A1:2000/A2:2003 Class B
EN 55024:1998/A1:2001/A2:2003
EN 61000-3-2:2000/A1:2001
EN 61000-3-3:1995/A1:2001

following the provision of the EMC Directive
(89/336/EEC,2004/108/EEC)

SAFETY PRECAUTIONS

Camera notes:

- ❗ Do not store or use the camera in the following types of locations:
 - In the rain, very humid and dusty places.
 - In a place where the camera can be exposed directly to the sunlight or subject to high temperature, e.g. Inside a closed car in summer.
 - In a place where the camera is subject to a high magnetic field, e.g. near motors, transformers or magnets.
- ❗ Do not place the camera on a wet surface or places where dripping water or sand may come in contact with the camera, which may cause irreparable faults.
- ❗ If the camera will not be used for a long period of time, we suggest you remove the battery and the memory card.
- ❗ If you carry the camera suddenly from a cold location to a warm place, moisture may condense inside the camera. We suggest you wait for a while before turning on the camera.
- ❗ No compensation for loss of recordings. Loss of recordings cannot be compensated for if a malfunction of your camera or recording media, etc, makes the playback of recordings not possible.

Battery notes:

- ❗ Incorrect use of the batteries may cause them to leak, become hot, ignite or burst. Always observe the precautions given below.
 - Do not expose the batteries to water, and take particular care to keep the terminals dry.
 - Do not heat the batteries or throw them into a fire.
 - Do not attempt to deform, disassemble or modify the batteries.
- ❗ Keep the batteries out of reach of babies and small children.
- ❗ In cold locations, battery performance deteriorates and the time for which they can be used shortens markedly.

Memory card notes:

- ❗ When using a new memory card, or a memory card has been initialized by a PC, be sure to format the card with your digital camera before using it.
- ❗ To edit image data, copy the image data to the PC's hard disk and then edit the copied data.
- ❗ Do not change or delete the directory names, or file names on the memory card from your PC, as this may make it impossible to use the card in your camera.

BEFORE YOU START

Preface

Thank you for purchasing the GE E850 digital camera. Please read this manual carefully and keep it in a safe place for future reference.

Copyright

© Copyright 2007 General Imaging Company All rights reserved.

No part of this publication may be reproduced, transmitted, transcribed, stored in a retrieval system, or translated into any language or computer language, in any form, by any means, without the prior written permission of General Imaging Company.

Trademarks

All trademarks mentioned in this manual are used for identification purposes only and may be properties of their respective owners.

Safety information

Please read the following important information carefully before using the product.

- Do not take apart or attempt to service the camera yourself.
- Do not drop or knock the camera. Improper handling may damage the product.
- Turn off the camera before inserting or removing the battery and memory card.
- Use only the type of battery and charger that came with your camera. Using other types of batteries or chargers may damage the camera and invalidate the warranty.
- When using Li-ion batteries in this product, ensure that they are inserted correctly. Inserting the batteries upside down can cause damage to the camera and possibly start a fire.
- Do not touch the camera lens.

- Do not expose the camera to moisture, or extreme temperatures. Extreme environments may shorten the life of your camera or damage the batteries.
- Do not use or store the camera in dusty, dirty, or sandy areas, as its components may be damaged.
- Do not expose the lens to direct sunlight for extended periods.
- Download all pictures and remove the batteries from the camera if you are going to store the camera for long periods.
- Do not use abrasive cleansers, alcohol-based, or solvent-based cleaners to clean the camera. Wipe the camera with a slightly damp soft cloth.

About this manual

This manual provides you with instructions on how to use your GE digital camera. Every effort has been made to ensure that the contents of this manual are accurate, but General Imaging Company reserves the right to make changes without notice.

Symbols used in this manual

Throughout this manual, the following symbols are used to help you locate information quickly and easily.



Indicates the useful information to know.



Indicates the precautions to be taken while operating the camera.

CONTENTS

| | | | |
|-----------------------------------|----|--|----|
| BEFORE YOU START | 1 | Inserting an SD/SDHC card..... | 12 |
| Preface | 1 | Turning on and off | 13 |
| Copyright..... | 1 | Using the Mode Dial | 14 |
| Trademarks..... | 1 | Setting display language, date, and time | |
| Safety information..... | 1 | Setting the Date and Time..... | 15 |
| About this manual | 2 | Setting the Language | 16 |
| Symbols used in this manual | 2 | About the LCD screen..... | 17 |
| CONTENTS | 3 | BASIC OPERATION | 18 |
| GETTING READY | 7 | Shooting in Auto mode | 18 |
| Unpacking | 7 | Using the zoom function | 18 |
| Camera views | 8 | Using the flash..... | 19 |
| Front View | 8 | Using the self-timer..... | 19 |
| Back View | 8 | Using Macro mode..... | 20 |
| Top View | 9 | Exposure compensation..... | 20 |
| Left View | 9 | Advanced function menu | 21 |
| Bottom View | 9 | WB (White Balance)..... | 21 |
| Charging the battery | 10 | ISO..... | 22 |
| Inserting the battery..... | 10 | Quality..... | 22 |

| | | | |
|----------------------------------|-----------|---------------------------------------|-----------|
| Size..... | 23 | Night landscape..... | 31 |
| Color | 24 | Night portrait | 31 |
| USING THE MODES | 26 | Return to the scene mode palette | 32 |
| LCD Screen display | 26 | Panorama mode..... | 32 |
| Still shooting mode display..... | 26 | Image stabilization..... | 34 |
| Video shooting mode display..... | 28 | Face detection..... | 35 |
| Playback mode display..... | 29 | PLAYBACK..... | 36 |
| Scene mode..... | 30 | Viewing photos and videos..... | 36 |
| Sport..... | 30 | Editing video | 38 |
| Child..... | 30 | Thumbnail view | 39 |
| Indoor..... | 30 | Using zoom playback | |
| Leaf | 30 | (for still pictures only) | 40 |
| Snow..... | 31 | Using the erase button..... | 41 |
| Beach..... | 31 | USING THE MENUS | 42 |
| Fireworks..... | 31 | Still menu..... | 42 |
| Glass..... | 31 | AF mode(Auto-Focus mode) | 43 |
| Museum | 31 | Cont. AF(Continuous AF)..... | 44 |
| Landscape..... | 31 | Metering | 44 |

| | | | |
|---------------------------------------|----|-------------------------------------|-----------|
| Continuous shot..... | 45 | Red-eye removal..... | 56 |
| Grid | 45 | Setup menu | 57 |
| Review..... | 46 | Format | 57 |
| Digital zoom..... | 46 | Beep..... | 58 |
| Histogram | 47 | LCD brightness..... | 59 |
| Bulb shutter | 47 | Power save..... | 59 |
| Movie menu..... | 48 | Date/Time | 60 |
| Continuous AF | 48 | World time | 60 |
| Metering | 49 | File Numbering..... | 61 |
| Stabilization..... | 49 | Language..... | 61 |
| Playback menu..... | 50 | Video system | 62 |
| Protect | 50 | Copy | |
| Delete | 51 | (internal memory to memory card) .. | 62 |
| DPOF(Digital Print Order Format) | 52 | Reset..... | 63 |
| Text display | 53 | CONNECTIONS | 64 |
| Trim..... | 53 | Connecting to a TV | 64 |
| Resize | 54 | Connecting to a PC..... | 65 |
| Rotate..... | 54 | Setting the USB mode..... | 66 |
| Slide show | 55 | | |

| | |
|--|-----------|
| Transferring files to your PC | 66 |
| Connecting to a PictBridge compatible printer | 67 |
| Setting the USB mode | 68 |
| Using the PictBridge menu | 70 |
| Print with date | 70 |
| Print without date | 71 |
| Print index | 72 |
| Print DPOF | 72 |
| Exit | 73 |
| Appendices | 74 |
| Specifications | 74 |
| Error messages | 78 |
| Troubleshooting | 80 |

GETTING READY

Unpacking

Make sure that your package contains the following items. If any item is missing or appears to be damaged, please contact your vendor.

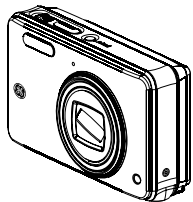

Camera



Rechargeable
Lithium-ion battery



User Manual



Quick start guide

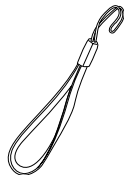

Wrist strap

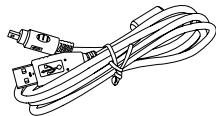

USB cable

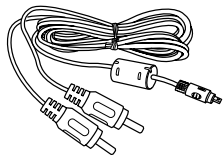

AV cable

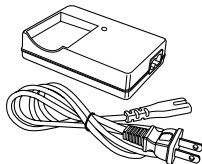

Battery charger

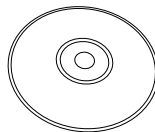

CD-ROM



Warranty card

Camera views

Front View

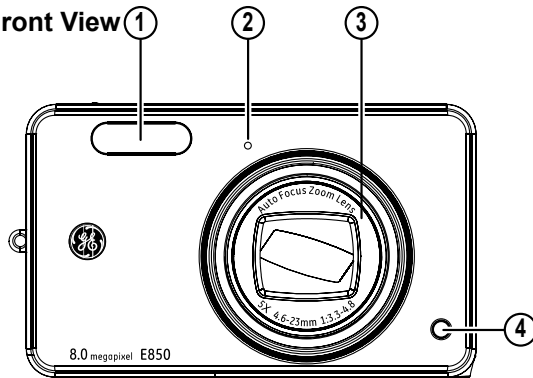

Back View

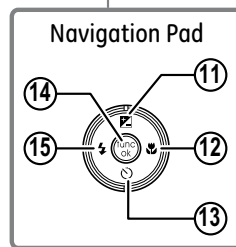
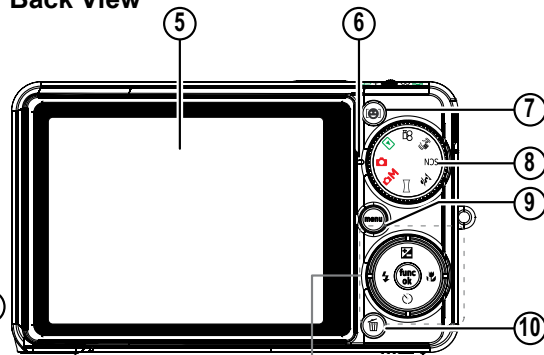

Top View

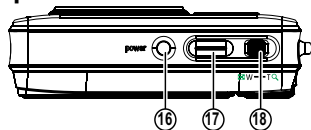

Bottom View

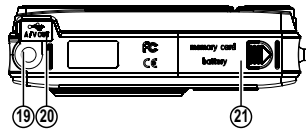

Left View

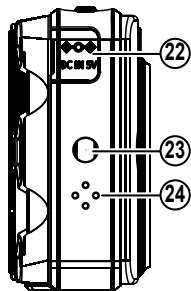

| | | | |
|----|---------------------------------|----|-----------------------------------|
| 1 | Flash | 13 | Self-timer/ Down button |
| 2 | Mic | 14 | Func/ok button |
| 3 | Lens | 15 | Flash mode/ Left button |
| 4 | AF assist beam/Timer indicator | 16 | Power button |
| 5 | LCD screen | 17 | Shutter button |
| 6 | Status LED | 18 | Zoom scroll wheel |
| 7 | Face detection AF button | 19 | Tripod mount point |
| 8 | Mode dial | 20 | USB/ AV port |
| 9 | Menu button | 21 | Memory card / Battery compartment |
| 10 | Erase button | 22 | DC IN port |
| 11 | Exposure compensation/Up button | 23 | Wrist strap mount |
| 12 | Macro mode/ Right button | 24 | Speaker |

Charging the battery

1. Place the battery into the charger as shown.
2. Plug one end of the connecting cable into the charger base.
3. Plug the other end of the connecting cable into a wall outlet.

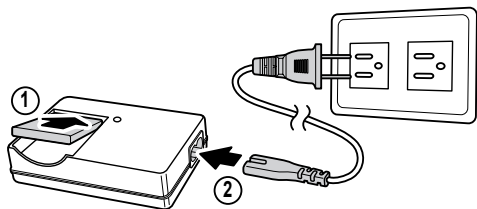

-  Leave the battery to charge until the charger light goes green.
(To maximize battery life, the first charge should be at least 4 hours)

Inserting the battery

1. Open the battery compartment.

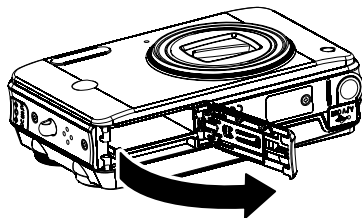
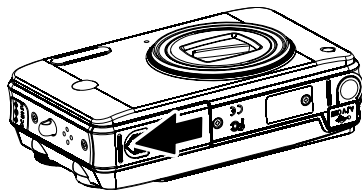

2. Insert the battery while observing the correct polarity. Use the side of battery to press down the stopper as shown, allowing the battery to be inserted properly.

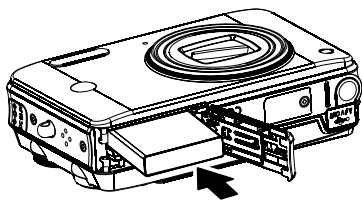
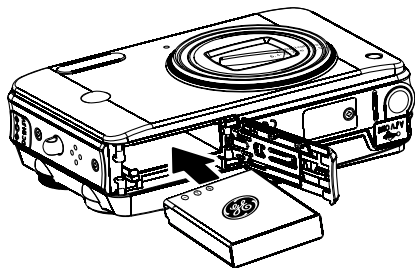

3. Close the battery compartment.

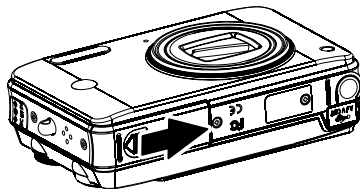
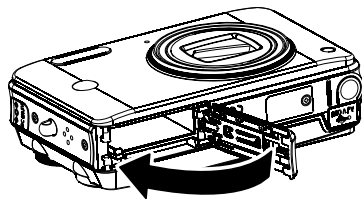

 Battery capacity decreases with usage

Inserting a SD/SDHC card

1. Open the battery compartment.

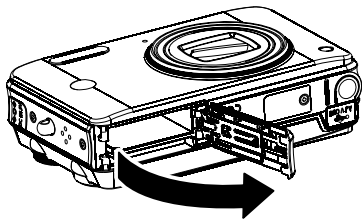
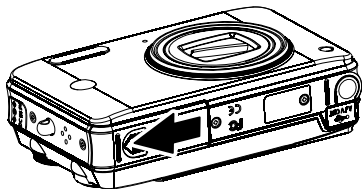

2. Insert a SD/SDHC card into the memory card slot as shown.

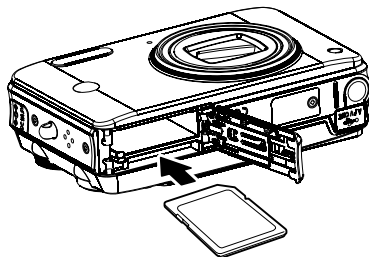
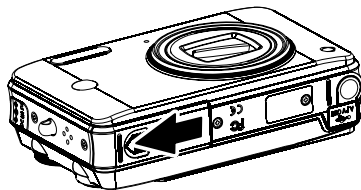

3. Close the battery compartment.

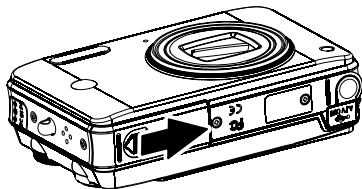
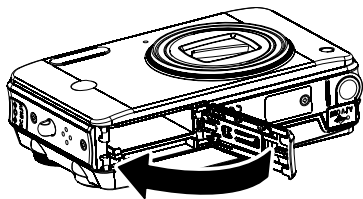

To remove the SD/SDHC card, open the battery compartment and gently push the card to release it. Pull the card carefully.

Turning on and off



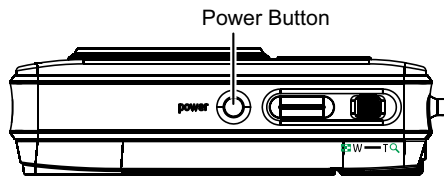



Press the **Power** button to turn the camera on. To turn off the camera, press the **Power** button again.



When turned on, the camera will enter the mode according to the mode dial setting. You can also turn the mode dial to change the modes after the camera is turned on.

Using the Mode Dial

The E850 camera provides a convenient mode dial that allows you to switch between different modes with ease. All the available modes are listed as follows.



| Mode Name | Icon | Description |
|---------------------|---|---|
| Auto |  | Switch to take still pictures. (The camera uses the default programmed automatic settings.) |
| Playback |  | Switch to view the pictures/videos stored on the memory card and internal memory. |
| Movie |  | Switch to record videos. |
| Image Stabilization |  | Switch to use Image Stabilization when taking still pictures. |
| Scene | SCN | Switch to use a preset scene mode for taking still pictures. There are 12 scenes in total. |
| Portrait |  | Switch to portrait mode when taking close-up portrait photos. |
| Panorama |  | Switch to capture a sequence of shots and stitch them together into a panoramic photo. |
| Manual |  | Switch to take still pictures in manual mode, where many camera settings can be configured. (Recommended for advanced users only) |

Setting display language, date, and time

To set the language ,date and time, the following settings need to be configured in the **Setup** menu.

- Date and Time
- Display language

To access the **Setup** menu, do the following:

1. Press **Power** to turn the camera on.
2. Press the  button and use **Up/Down/Left/Right** to select the **Setup** menu (.

-  When using the camera for the first time, the language menu will appear automatically.

Setting the Date and Time

1. Use the **Up/Down** to select **Date/Time**. Then press the **Right** to enter the setting.

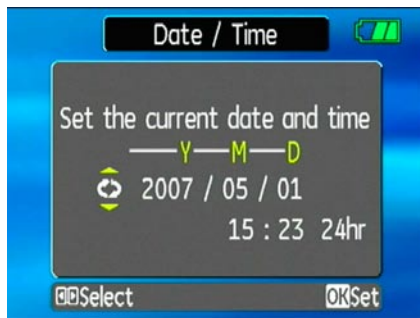

2. Press the **Left/Right** to highlight each field and use the **Up/Down** to adjust the value.
3. Press the  button to confirm the setting.

Setting the Language

1. Use the **Up/Down** to select **Language**. Then press the **Right** to enter the setting.



2. Use the navigation buttons to select the desired language.
3. Press the  button to confirm the setting.

About the LCD screen

When you turn the camera on, various icons are shown on the 3.0" LCD screen to indicate the current camera settings and status. To learn more about the displayed icons, see **"LCD Screen display"** on page 26.

LCD Screen notes:

Extremely high-precision technology had been used to manufacture the LCD screen so that most of the pixels are operational for use. However, there may be some minute points (black, white, red, blue or green) that constantly appear on the LCD screen. These points are normal in the manufacturing process and the recording is not affected in any way.



If the LCD monitor is damaged, take particular care with the liquid crystal in the monitor. If any of the following situations arise, take the urgent action indicated.

- If liquid crystal comes in contact with your skin, wipe the area with a cloth and then wash thoroughly with soap and running water.
- If liquid crystal gets into your eye, flush the affected eye with clean water for at least 15 minutes and then seek medical assistance.
- If liquid crystal is swallowed, flush your mouth thoroughly with water. Drink large quantities of water and induce vomiting. Then seek medical assistance.

BASIC OPERATION

Shooting in Auto mode

Auto mode is the easiest mode to take photos. While operating in this mode, the camera automatically optimizes your photos for best results.

To start shooting, do the following:

1. Set the mode dial to **Auto** mode ().
2. Press **Power** to turn the camera on.
3. Compose your picture on the LCD screen and press the shutter button halfway to focus on the subject.
4. When the subject is in focus, the green colored Focus frame appears on the center of the LCD screen.
5. Press **Shutter** fully to capture the image.



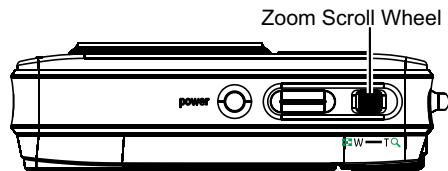

Using the zoom function

The camera is equipped with 5X optical zoom and 4.5X digital zoom. Use the **Zoom scroll wheel** on the top of the camera to zoom in or out on your subject while taking pictures.





Using the flash

There are four flash modes. Press the **Left/Flash** to cycle through the following flash modes.

-  Auto flash
Flash fires automatically when required.
-  Red-eye reduction flash
The camera fires a brief flash before the picture is taken to reduce red-eye effects.
-  Forced flash
Flash always fires.
-  Flash off
Flash is turned off.

Using the self-timer

To enable the self-timer function, press the **Down/Self-timer** to select 2-second timer delay, 10-second timer delay, or a continuous shot.

-  2-second timer delay
A single picture is shot 2 seconds after the shutter button is pressed.
-  10-second timer delay
A single picture is shot 10 seconds after the shutter button is pressed.
-  Continuous shot
Pictures are shot continuously when the shutter button is pressed based on the Continuous Shot settings in the menu. (See "Continuous Shot" on page 45).

Using Macro mode

In **Macro** mode, you can capture tiny details of the subject at a very close range. Press the **Right/Macro** to take close-up shots.

-  Macro
Select this to focus on subjects 5cm from the lens.

Exposure compensation

The exposure compensation allows you to adjust the background brightness to produce the best result of photos. To change the exposure values, do the following:

1. Press the **Up/Exposure** to display the exposure setting.



2. Use the **Left/Right** to adjust the exposure value for the picture. The range is from EV -2.0 to EV+2.0 (steps of 0.3).

Advanced function menu

WB (White Balance)

The white balance allows the user to adjust the color temperature under different light source to ensure faithful color reproduction.







To set the white balance, do the following:

1. Press the  button to enter the **Function** menu. Make sure the **WB** function is selected.



2. Use **Up/Down** navigation buttons to

select an option. The following options are available:

-  **AUTO** Auto
-  Day light
-  Cloudy
-  Incandescent
-  Fluorescent
-  Fluorescent H
-  Manual

3. Press the  button to confirm your setting.

 The WB setting is only available when the camera is in the **Manual** mode.

ISO

The ISO function allows you to set the camera sensor sensitivity to light. To improve the performance in darker environments, a higher ISO value is required. On the other hand, a lower ISO value is needed when in bright conditions.

To set the ISO value, do the following:

1. Press the  button to enter the **Function** menu.
2. Use the **Left/Right** navigation buttons to highlight the **ISO** function.

 Higher ISO pictures will naturally have more noise than lower ISO pictures.



3. Use the **Up/Down** navigation buttons to select the desired ISO value from **Auto**, **80**, **100**, **200**, **400**, **800**, or **1600**.
4. Press the  button to confirm your setting.

Quality



The quality setting adjusts the compression ratio of the images. Higher quality settings give better photos, but will take up more memory space.

To set the image quality, do the following:

1. Press the  button to enter the **Function** menu.
2. Use the **Left/Right** navigation buttons to highlight the **Quality** function.



3. Use the **Up/Down** navigation buttons to select a desired setting. Three options are available.
 -  : Best quality (Standard compression)

-  : Fine quality (High compression)
-  : Normal quality (Maximum compression)

4. Press the  button to confirm your setting.

Size





The size setting refers to the image resolution in pixels. A higher image resolution allows you to print that image in larger sizes without degrading the image.

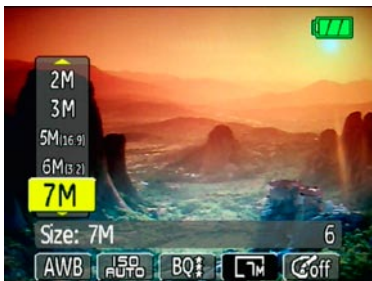



To set the image size, do the following:

1. Press the  button to enter the **Function** menu.
2. Use the **Left/Right** navigation buttons to highlight the **Size** function.



3. Use the **Up/Down** navigation buttons to select a resolution. The following options are available:

-  0.3M: 640x480
-  1M: 1024x768
-  2M: 1600x1200
-  3M: 2048x1536

-  5M : 2560x1920
-  6M (16:9): 3264x1836
-  7M (3:2): 3264x2176
-  8M : 3264x2448

4. Press the  button to confirm your setting.

Color

The color setting allows you to add artistic effects directly when taking shots. You can try different color tones to alter the mood of your pictures.

To set the image color, do the following:

1. Press the  button to enter the **Function** menu.
2. Use the **Left/Right** navigation buttons to highlight the **Color** function.



2. Use **Up/Down** to select an option.
The following options are available:

- **Off** Off
- **BW** Black & White
- **SE** Sepia
- **VIVID** Vivid

4. Press the  button to confirm your setting.

USING THE MODES

LCD Screen display

Still shooting mode display

Mode: SCN

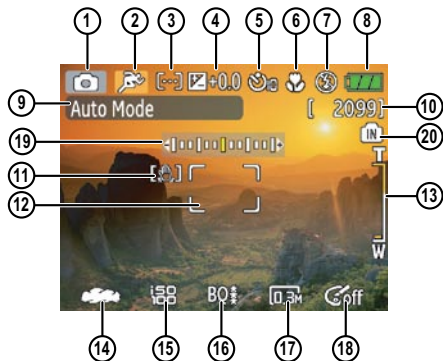

1 Shooting mode icon



2 Scene icon (only available for **Scene** mode)



3 Light metering method

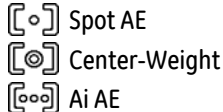

4 EV indicator

5 Self-timer indicator

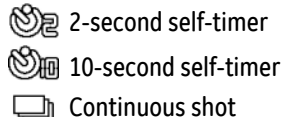

6 Macro mode indicator



Macro mode

7 Flash mode indicator



Auto flash



Red-eye reduction flash



Forced flash



Flash off



Slow Synchro



Red-Eye Reduction+Slow Synchro

8 Battery status

9 Mode name

Appears for 3 seconds when the mode is first switched to.

10 Remaining number of photos that can be taken.

11 Warning icon



Appears when the camera is held unsteadily.

12 Focus frame

13 Zoom indicator

14 White balance (only available for **Manual** mode)

15 ISO (only available for **Manual** mode)

16 Image quality

17 Image size

18 Image color (only available for **Manual** mode)



19 EV adjustment bar

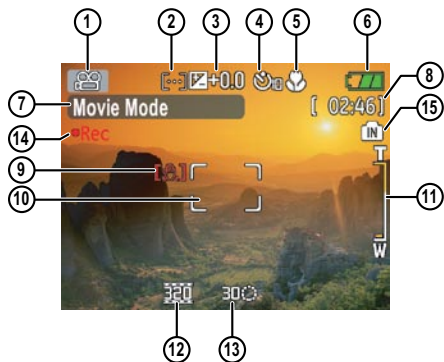

20 Memory card/internal memory indicator

Video shooting mode display

Mode: 



- 1 Shooting mode icon
- 2 Light metering method
 -  Spot AE
 -  Center-Weight
 -  Ai AE
- 3 EV indicator

- 4 Self-timer indicator
 -  2-second self-timer
 -  10-second self-timer
 -  Continuous shot

- 5 Macro mode indicator
 -  Macro mode

- 6 Battery status

- 7 Mode name

Appears for 3 seconds when the mode is first switched to.

- 8 Remaining time for videos that can be taken.

- 9 Warning icon

 Appears when the camera is held unsteadily.

- 10 Focus frame

- 11 Zoom indicator

- 12 Video resolution

- 13 Video quality

14 Record icon

15 Memory card/internal memory indicator

For best movie results, the use of SD cards is recommended. Movie recordings using internal memory are subject to quality degradations.

While movie recording is in progress, optical zoom will stay fixed, but up to 1.5X digital zoom will remain available.

Playback mode display

Mode: 

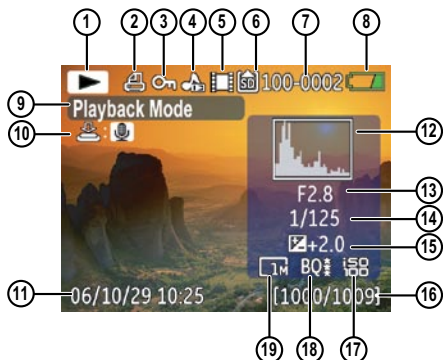

1 Playback mode icon

2 DPOF file icon

3 File protection icon

4 Audio file icon

5 Video file icon

6 Memory card/internal memory indicator

7 Picture ID

8 Battery status

9 Mode name

10 Photo audio status



No audio recording



Audio recording present

11 Recording date and time

12 Histogram

13 Aperture value

14 Shutter speed

15 Exposure value

16 Memory capacity (current picture/total picture number)

17 ISO value

18 Image quality

19 Image size

Scene mode

In **Scene** mode, you can select from a total of 12 scene types to match your needs. You just need to select the right scene for the occasion and the camera will automatically adjust to the optimal settings for you.

To enter the scene mode, turn the mode dial to **Scene** mode. The scene mode palette appears.



Use **Up/Down/Left/Right** to select a scene, and press the  button.

Sport

For shooting fast-moving objects. Bring lively pictures to life.

Children

For shooting kids and pets. No flash to avoid disturbances.

Indoor

For shooting people indoors. Clearly shows background and atmosphere.

Leaf

For shooting plants. Vivid reproduction of green.

Snow

For shooting snow scenes. Balances the white scenery.

Sunset

For shooting sunsets. Vivid reproduction of red and yellow.

Fireworks

For shooting at night and fireworks. Shutter-speed is slower than normal.

Glass

For shooting objects behind transparent glass.

Museum

For shooting in museums or places where flash is not allowed.

Landscape

For shooting landscapes. Vivid reproduction of green and blue.

Night landscape



For shooting night scenes. Use of tripod is recommended.

Night portrait

For shooting portraits with night scenes as background.

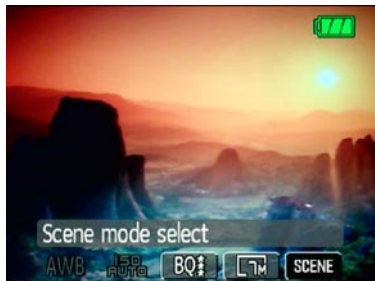
Return to the scene mode palette



1. In **Scene** mode, press the  button to enter the **Function** menu.
2. Use the **Left/Right** navigation buttons to highlight the **Scene mode selection**.
3. Press the  button to return to the scene mode palette.

You can also set the Image Quality and Image Size from the Function menu. For more setting details on the options, refer to “**Advanced function menu**” on page 21.

Panorama mode

Panorama mode allows you to shoot ultra wide panoramic shots. It allows you to create beautiful wide-view photos by stitching three images into a single panoramic picture.

To stitch a panoramic picture, follow the steps below:

1. Set the mode dial to **Panorama** mode ().



2. Use the **Left/Right** navigation buttons to select which side to record from; left to right or right to left. Then press the  button.
3. Compose your first view on the LCD screen and press the shutter button.
4. The frame record icon will display under the focus frame to indicate the number of photos you have taken.

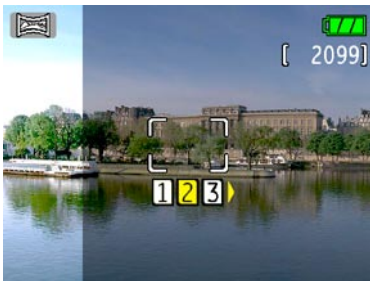

5. Capture the second and third views as taking the first view, making sure that the edges of pictures overlap.

6. The camera will then stitch the pictures into a panorama automatically.
7. Set the mode dial to playback mode to view the result.



Image Stabilization mode

The Image Stabilization mode combats the effect of hand shake and allows you to take pictures that would otherwise be blurred.



1. Switch the mode dial to () mode.
2. Press **Shutter** halfway to focus on the subject.
3. Press **Shutter** fully to capture the image.

Setting the Image Stabilization function under () mode.

1. Switch the mode dial to () mode.
2. Press **Menu**, and use **Up/Down** to select the Image Stabilization settings.
3. Press () to confirm the setting, and then start shooting the movie.

() "Stabilization during Movie mode is only available when the Frame Rate is set to 15 fps"

Face Detection

The Face Detection mode will detect the faces of persons in a photo so that the faces will be as clear as possible.

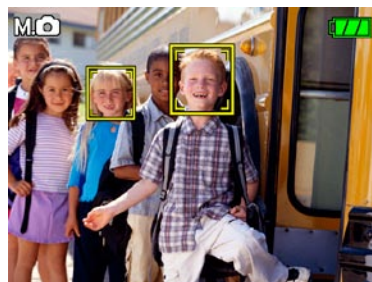

1. In Shooting mode, press  to enable Face Detection.
2. Hold the camera securely, and point the camera towards the subject to start the face detection process. When the camera detects a face, a white rectangular frame will be drawn around the face. If no faces can be detected, a circular frame will appear on the LCD screen. (Note: For best results, the face of the subject should be relatively large on the LCD screen, and the subject should be facing the camera as front on as possible.)
3. Press **Shutter** halfway to focus on the subject.



4. Press **Shutter** fully to capture the image.

Viewing photos and videos

To view the captured photos and video clips on the LCD screen:

1. Turn your camera to **Playback** mode.
The last recorded photo or video clip is displayed.
2. Use the **Left/Right** navigation buttons to scroll through the photos or video clips stored in the internal memory or memory card.
3. To play a selected video clip, press the  button to enter the movie playback mode.
4. Use the **Left/Right** navigation buttons to select a program button and press the  button to confirm the selection. The function of each button is described in the following.



- | | | | |
|---|-------------|---|----------------|
| 1 | Exit | 5 | Previous frame |
| 2 | Play | 6 | Next frame |
| 3 | Slow motion | 7 | Edit Movie |
| 4 | First frame | | |

During the video playback, an operation guide appears on the screen. You can use the navigation pad to perform the functions accordingly.



During the slow motion playback, you can use the **Left/Right** navigation buttons to adjust the speed of playback.





Volume will be muted when using the slow motion playback.



Editing video

Press the **Edit**  program button to enter the following screen and use the buttons on the left side to edit the playback. Use the **Up/Down** navigation buttons to select a button.



1. Select the  button and use the **Left/Right** navigation buttons to specify the new beginning of the playback.
2. Select the  button and use the **Left/Right** navigation buttons to specify the

new end of the playback.

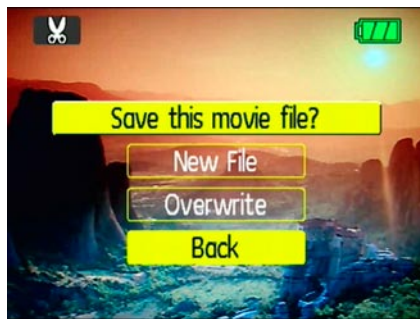

2. Select the  button to play the editing section.
3. To save the file, select the  button and press the  button.
4. Use the **Up/Down** navigation buttons to select an option.



- **New file:** Save as a new file.
- **Overwrite:** Overwrite the original file.

- **Back:** Do not save the file and return to the Edit screen.
5. Press the  button to confirm your setting.

To exit the Edit screen, select the  button and press the  button.

-  Edited video must be at least 1 second long to be saved.
-  With sufficient battery and at least 1GB of available memory, up to 30 minutes of footage can be recorded per movie.

Thumbnail view

When in **Playback** mode, move the zoom scroll wheel to the Wide position ( W) once to display the thumbnail of photos and video clips on the screen.

1. Use the zoom scroll wheel to switch between the **2x2**, **3x3**, and **4x4** thumbnail display.
2. Use **Up/Down/Left/Right** to select a photo or video clip to view.

Using zoom playback (for still pictures only)

The camera's zoom scroll wheel can also be used during playback. This allows you to magnify photos up to 8X.

1. Turn your camera to **Playback** mode.
2. Use the **Left/Right** navigation buttons to select a photo to magnify.
3. Move the zoom scroll wheel to the Tele position (T Q) once.
4. Use the zoom scroll wheel to zoom in and out. The zoom indicator and pan box appear on the screen.



5. Use the navigation buttons to pan across the image.
6. Press the  button to return the image to its original scale.

Using the Delete button



The camera is equipped with a quick **Delete** button  for you to delete photos or video-clips without entering the **Playback** menu.

To delete a photo or video:

1. Turn your camera to **Playback** mode.
2. Use the navigation buttons to select the photo/video clip you want to delete.
3. Press the  button. The Delete screen appears.



4. Press the **Up/Down** navigation buttons to select **Yes** or **No**. Then press the  button to confirm.

-  Erased photos/video clips cannot be recovered.
-  See the Delete All function on page 52 to delete all photos/video clips in a single operation.

USING THE MENUS

Still menu

Mode: SCN M

In still shooting modes, press the button to enter the **Still** menu.



To configure the settings:

1. Use the **Up/Down** navigation buttons to scroll through the menu items.
2. Press the **Right** navigation button to enter the submenu.

3. Use the **Up/Down** navigation buttons to select an option.
4. Press the button to confirm the setting and exit the menu.

Refer to the following sections for more detailed information on each setting.

AF mode(Auto-Focus mode)

Use this setting to control the auto-focus mechanism while taking pictures.



Two options are available:

- **Single-AF:** The focus frame appears on the center of the LCD screen to focus on the subject.
- **Multi-AF:** The camera automatically focuses the subject in a wide area to find the focus point.

AF-assist beam

Use this setting to aid focus in dark conditions. Select **On** to turn on the AF assist beam, or **Off** to disable the function.

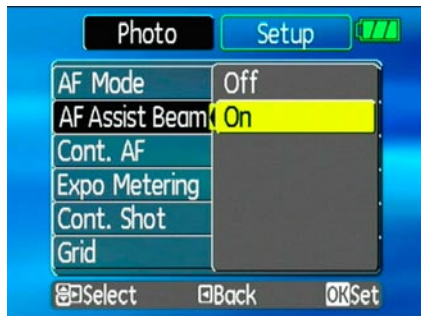

Cont. AF (Continuous AF)

Use this setting to turn **On** or **Off** the auto continuous focus function when shooting on a moving subject.

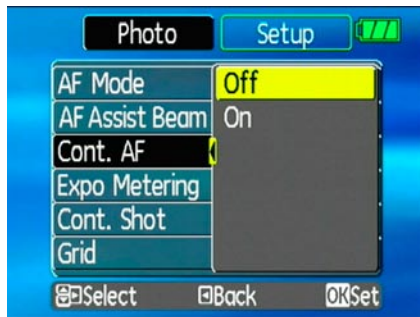

Expo Metering (Exposure Metering)

Use this setting to select an area for the exposure to be obtained.

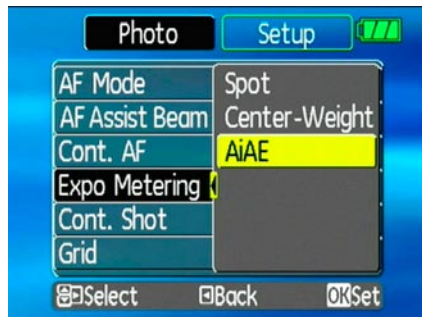

Three options are available:

- **Spot AE (Spot Auto Exposure)**
- **Center-Weight**
- **AiAE (Artificial Intelligence AE)**

Cont. Shot (Continuous shot)

Use this setting to perform continuous shooting. An extended press of the shutter button is required.



Four options are available:

- **Off:** Capture a single shot only.
- **5 shot:** Capture up to 5 consecutive pictures.
- **Last 5 shots:** Capture pictures continuously until the shutter button is released

but only the last 5 shots are recorded.

- **Time-Lapse :** Automatically capture pictures in at predefined intervals.

Grid

Use this setting to turn on or off the framing grids when taking photos. This may help you position the subject in your composition.

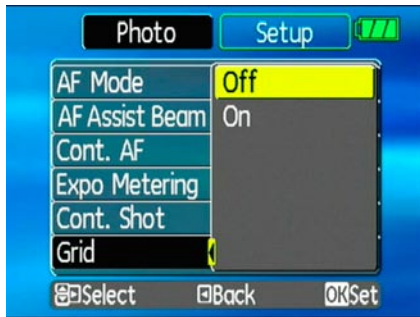

Quick Review

This setting refers to the quick photo review immediately after taking a picture. The picture stays on the LCD screen for an adjustable period of time.



Three options are available:

- **1 Sec**
- **2 Sec**
- **3 Sec**

Digital zoom

Use this setting to enable or disable the digital zoom function. When disabled, only the optical zoom is enabled.



Histogram

The histogram is used for checking the exposure while taking pictures. Use this setting to enable or disable the histogram display on the LCD screen.



Slow Shutter

Slow Shutter mode will keep the shutter open as long as you push down the shutter button. So, you are in complete control of the exposure.



- **Manual:** To set a long exposure time between 2~30 sec.

Movie menu

Mode: 

In movie shooting mode, press the  button to enter the **Movie** menu.



To configure the settings:

1. Use the **Up/Down** navigation buttons to scroll through the menu items.
2. Press the **Right** navigation button to enter the submenu.

3. Use the **Up/Down** navigation buttons to select an option.
4. Press the  button to confirm the setting and exit the menu.

Refer to the following sections for more detailed information on each setting.

Continuous AF

See "**Continuous AF**" section on page 44.



Expo Metering (Exposure Metering)

See “**Expo Metering**” section on page 44.



Stabilization

See “**Stabilization**” section on page 34.



Playback menu

Mode: ▶

In playback mode, press the  button to enter the **Playback** menu.

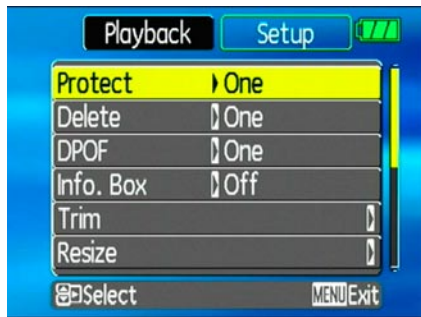

To configure a setting:

1. Use the **Up/Down** navigation buttons to scroll through the menu items.
2. Press the **Right** navigation button to enter the setting.



Refer to the following sections for more detailed information on each setting.

Protect

To prevent pictures or videos being erased accidentally, you can use this setting to lock one or all files.



To protect/unprotect a picture or video:

1. Turn your camera to **Playback** mode and display the picture or video that you would like to protect.
2. Select the **Protect** setting from the **Playback** menu as described previously.
3. Use the **Up/Down** navigation buttons to select **One** to protect this picture/video, or select **All** to protect all pictures/videos in the internal memory or memory card. Then press the **Right** navigation button.
4. Use the  button to select **Yes** to lock the displayed picture/video or **Unlock** to unlock it, and use the **Up/Down** navigation buttons to select **Back** to return to the **Playback** menu.
5. A key () icon will appear at the top of the screen to indicate that the picture/video is protected.



Delete

This setting allows you to delete a single or all files stored in the internal memory or your memory card.



To delete a picture or video:

1. Turn your camera to **Playback** mode and display the picture or video to delete on the LCD screen.
2. Select the **Delete** setting from the **Playback** menu as described previously.

3. Use the **Up/Down** navigation buttons to select **One**, and press the **Right** navigation button.
4. Use the  button to select **Yes** to confirm the deletion or **Back** to cancel.
5. Press the  button to confirm the setting and exit the menu.

To delete all files:

1. Select the **Delete** setting from the **Playback** menu as described previously.
2. Use the **Up/Down** navigation buttons to select **All**, and press the **Right** navigation button.
3. Use the **Left/Right** navigation buttons to select **Yes** to delete all the files or **No** to cancel.

DPOF (Digital Print Order Format)

DPOF allows you to record your selection of pictures that you would like to print, and will save your selection on the memory card, so that you can simply hand your memory card to a photo kiosk without having to tell them in person which photos you would like to print.



Info. Box (Information Box)

Use this setting to enable or disable the text display for taking pictures. The following information will be displayed on the screen: histogram display, aperture value, shutter speed, exposure value, image size, image quality, and ISO value.



Trim

The trim setting allows you to trim a picture to adjust the part that you desired and save it as a new picture.

To trim a picture:

1. Select the **Trim** setting from the **Playback** menu as described previously.
2. Use the zoom scroll wheel and navigation buttons to adjust the trimming box to fit the location and size of the new picture.



3. Press the **Shutter** button to save what you see on the LCD screen as a new picture, or the  button to cancel and return to the **Playback** menu.



Resize

This setting allows you to resize picture to a specified resolution, and save it as a new picture.

1. Select the **Resize** setting from the **Playback** menu as described previously.



2. Use the **Left/Right** navigation buttons to select a picture to resize.
3. Use the **Up/Down** navigation buttons to select a resolution (**1024X768** or **640X480**) to resize the image or **back** to cancel and return to the **Playback** menu.
4. Press the  button to confirm the setting.

-  Resizing an image creates a new file that contains the image in the size you select. The file with the original image also remains in memory.
-  If the message "The image cannot be edited." appears, it means that the current image cannot be resized.

Rotate

You can use this setting to change the picture orientation of the picture.

1. Select the **Rotate** setting from the

Playback menu as described previously.

2. Use the **Left/Right** navigation buttons to select a picture to rotate.

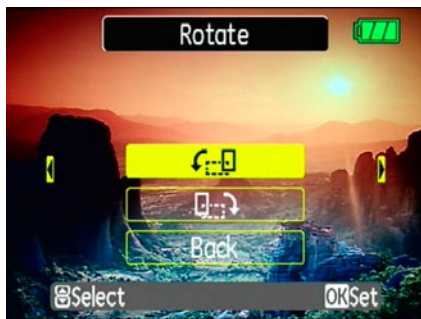

3. Use the **Up/Down** navigation buttons to select the direction for rotation or **Back** to cancel and return to the **Playback** menu.
4. Press the  button to confirm the setting.

 The rotated image will be saved as a new file, and the original image will remain intact in memory.

Slide show

This setting allows you to view all the stored pictures as a slideshow.

1. Select the **Slide show** setting from the **Playback** menu as described previously.
2. Use the **Up/Down** navigation buttons to select Effect, Interval time, or Repeat and use the **Left/Right** navigation buttons to adjust the setting.



3. Use the **Up/Down** navigation buttons

- to select **Start** to run the slideshow or **Cancel** to return to the **Playback** menu.
4. Press the  button to confirm the setting.

Red-eye removal

Use this setting to remove red eye effect in your photos.

1. Select the **Red-eye removal** setting from the **Playback** menu as described previously.
2. Use the **Left/Right** navigation buttons to select the image for which red-eyes will be removed.
3. Use the **Up/Down** navigation buttons to select **Yes** to fix the selected image or **back** to cancel and return to the **Playback** menu.

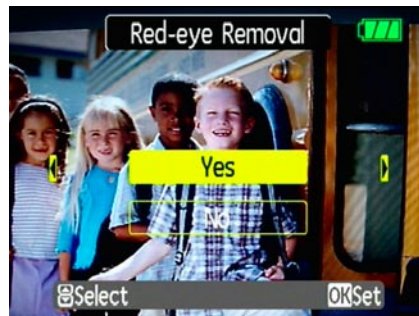

4. Press the  button to confirm the setting.

 For best results, the face of the subject should be relatively large on the LCD screen, the subject should be facing the camera as front on as possible, and the red eyes should be as large as possible.

Setup menu

Mode: SCN

The **Setup** menu is available in all modes. Press the button in any modes, then use the navigation buttons to select the **Setup** menu.

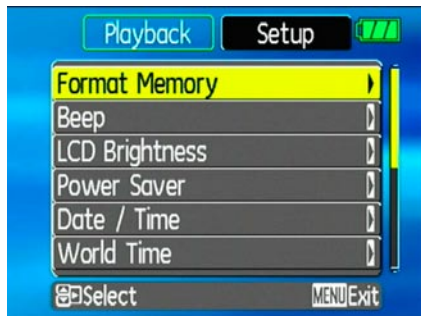

To configure the settings:

1. Use the **Up/Down** navigation buttons to scroll through the menu items.

2. Press the **Right** navigation button to enter the setting.

Refer to the following sections for more detailed information on each setting.

Format Memory

The format function allows you to erase all data in the memory card, and internal memory including the protected pictures and video clips.

To use this setting:

1. Select the **Format Memory** setting from the **Setup** menu as described previously.

2. Use the **Left/Right** navigation buttons to select **Yes** or **No**, and press the  button to confirm.



3. The current media is formatted.

Beep

Use this setting to adjust the volume of beep when buttons are pressed and change the tones for shutter, buttons, self-timer, and power-on/power-off.

To change this setting:

1. Select the **Beep** setting from the **Setup** menu as described previously.
2. Use the **Up/Down** navigation buttons to switch between volume, shutter tone, key tone, self-timer tone, and power tone fields.



3. Use the **Left/Right** navigation buttons to adjust the volume and change each tone style. Then press the  button to confirm.

LCD Brightness

Use this setting to adjust the brightness of your LCD screen.

1. Select the **LCD Brightness** setting from the **Setup** menu as described previously.
2. Use the **Left/Right** navigation buttons to adjust the brightness level. Then press the  button to confirm.



Power Saver

This setting allows you to save power and get the maximum possible running time for your battery. Follow the steps below to turn off the LCD screen and camera automatically after a period of inactivity.

1. Select the **Power Save** setting from the **Setup** menu as described previously.
2. Use the **Up/Down** navigation buttons to switch between LCD power and Camera power fields.



3. Use the **Left/Right** navigation buttons to specify the idle period before automatic power-off. The level bars correspond to the following idle periods.

- LCD power:
30 seconds, 1 minute, 2 minutes, and Always on.
- Camera power:
3 minutes, 5 minutes, 10 minutes, and Always on.

4. Press the  button to confirm.



Date/Time

See “**Setting the Date and Time**” section on page 15.

World time

The world time setting is a useful function on your overseas trips. This feature enables you

to display the local time on the LCD screen while you are overseas.

1. Select the **World time** setting from the **Setup** menu as described previously. The world time screen appears.
2. Use the **Up/Down** navigation buttons to switch between the hometown () and travel destination () fields.
3. Use the **Left/Right** navigation buttons to select a city close to the desired time zone. Then press the  button to confirm.



File Numbering

After capturing photos or videos, the camera will automatically save the file with a numeric suffix. You can use this setting to determine whether the number should continue on from the last photo you have taken, or reset the counter to 1 and save files in a new folder in the memory card.

1. Select the **File numbering** setting from the **Setup** menu as described previously.
2. Use the **Up/Down** navigation buttons to select **Yes** or **No**. Then press the  button to confirm.



Language

See “**Setting the Language**” section on page 16.

Video system

Use this setting to determine your video system in the current area.

1. Select the **Video system** setting from the **Setup** menu as described previously.
2. Use the **Up/Down** navigation buttons to

select **NTSC** or **PAL**. Then press the  button to confirm.



The video output signal can be switched to NTSC or PAL to accommodate different regional standards. The appropriate setting will vary between regions.

NTSC: USA, Canada, Taiwan, Japan, etc.

PAL : Europe, Asia (excluding Taiwan), Oceania, etc.

Note: The TV output will not display properly if an incorrect video system is selected.

Copy to Card (Copy internal memory to memory card)

Use this setting to copy the files stored in the internal memory to the memory card.

1. Select the **Copy to memory card** setting from the **Setup** menu as described previously.
2. Use the **Up/Down** navigation buttons to select **Yes** or **No**. Then press the  button to confirm.



Reset Settings

Use this setting to restore the camera to its default settings.

1. Select the **Reset** setting from the **Setup** menu as described previously.
2. Use the **Up/Down** navigation buttons to select **Yes** or **No**. Then press the  button to confirm.

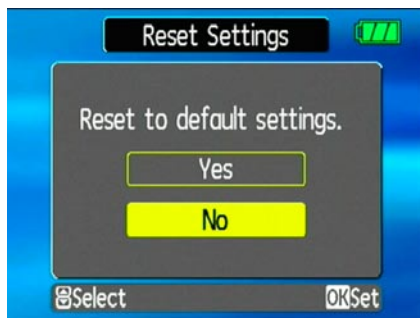

FW Ver.(Firmware version)

Use this setting to view the current camera firmware version.

1. Select the **FW Ver.** setting from the **Setup** menu as described previously.



CONNECTIONS

Connecting to a TV

- Make sure that both the camera and TV are turned off before connecting the AV cable.

By using the AV cable, you can view the captured images on a TV. Follow the steps below to connect the supplied AV cable to a TV.

1. Connect one end of the AV cable to the USB/AV OUT port on your camera.
2. Connect the plugs on the other end of the cable to the audio and video input ports on the TV.
3. Turn on the camera and the TV on.

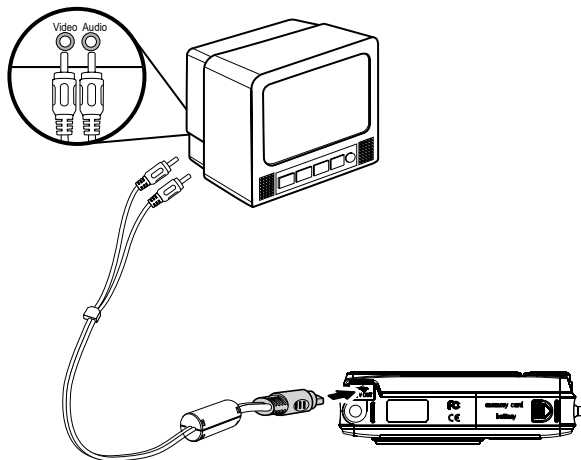

Connecting to a PC

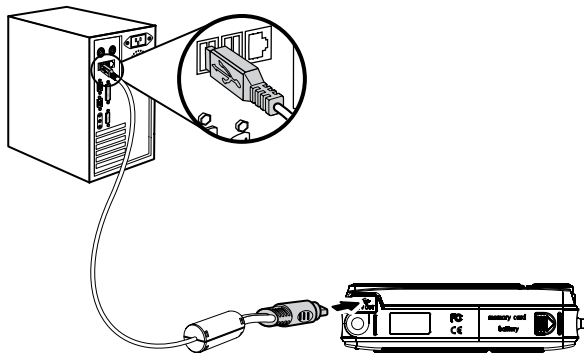

By using the USB cable, you can transfer the captured photos and videos to a PC. Follow the steps below to connect the camera to a PC.

1. Make sure both the camera and PC are turned on.
2. Connect one end of the supplied USB cable to the USB/AV OUT port on your camera.
3. Connect the other end of the cable to an available USB port on your PC.



Setting the USB mode

Since the camera's USB port can be set to connect with either a PC or a Printer, the following steps will allow you to ensure that the camera is correctly configured to connect with a PC.

1. Press the  button and use the **Up/Down** navigation buttons to select USB Connect, and then press the Right navigation button.
2. Use the **Up/Down** navigation buttons to select PC.
3. Press the  button to confirm the setting.

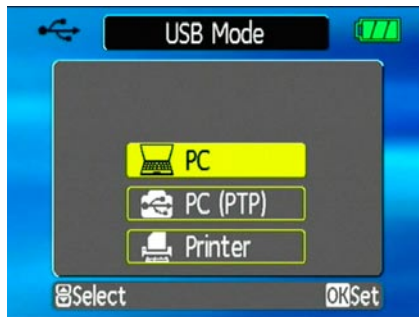

Transferring files to your PC

The computer will automatically detect the camera as a removable drive. Double-click **My Computer** icon on the desktop to locate the removable drive and to copy the folders and files in the drive to a directory on your PC as you would copy any typical folder or file.

Connecting to a PictBridge compatible printer

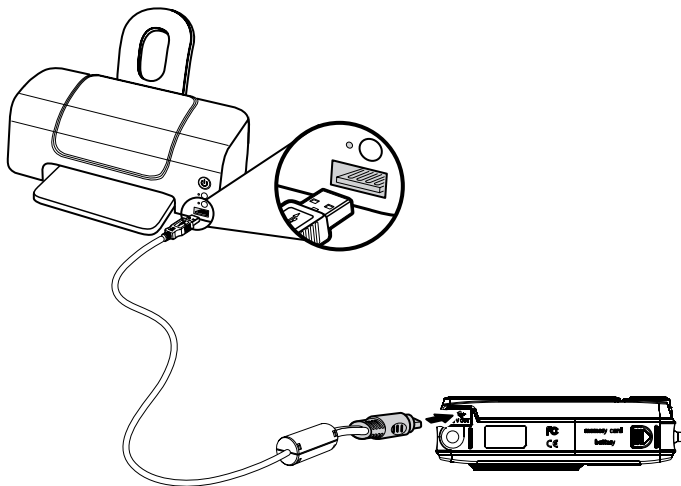

With the PictBridge function on your camera, you can print the captured photos directly with a PictBridge compatible printer using the supplied USB cable, without the need for a PC.

1. Make sure both the camera and printer are turned on.
2. Connect one end of the supplied USB cable to the USB port on your camera.
3. Connect the other end of the cable to the USB port on the printer.



Setting the USB mode

Since the camera's USB port can be set to connect with either a PC or a Printer, the following steps will allow you to ensure that the camera is correctly configured to connect with a Printer.

1. Press the  button and use **Up/Down** to select USB Connect, and then press the Right navigation button.
2. Use **Up/Down** to select Printer.
3. Press the  button to confirm the setting.

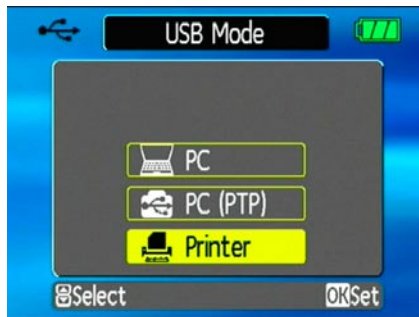

If the camera is not connected to a PictBridge compatible printer, the following error message appears on the LCD screen.



The above error message would also appear if the USB mode were set incorrectly, in which case you should disconnect the USB cable, check the USB mode settings, ensure that the Printer is turned on, and then try connecting the USB cable again.

Using the PictBridge menu

After setting the USB mode to Printer, the **PictBridge** menu appears.

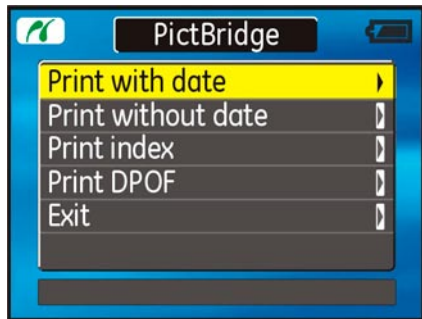

Use the **Up/Down** navigation buttons to select a menu item, and press the **Right** navigation button to enter.

Refer to the following sections for more detailed information on each setting.

Print with date

If you have set the date and time of your camera, the date record would be saved with the photos you take. You can print the photos with date by following the steps below.

1. Select **Print with date** from the **PictBridge** menu. The following screen appears.

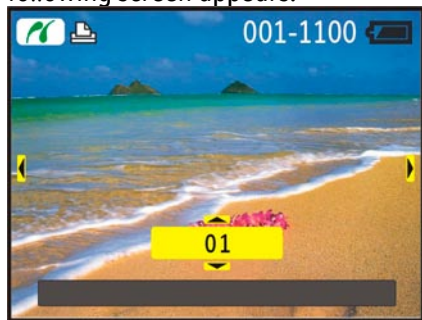

2. Use the **Left/Right** navigation buttons to scroll through the photos.
3. Use the **Up/Down** navigation buttons to select the number of prints for the current displayed photo.
4. Press the  button and the following screen appears.

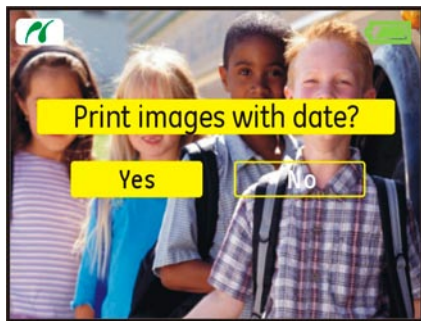

5. Select **Yes** to confirm printing, or **No** to cancel. Then press the  button.

Print without date

Use this setting to print the photos without dates on them.

1. Select **Print without date** from the **PictBridge** menu. The following screen appears.

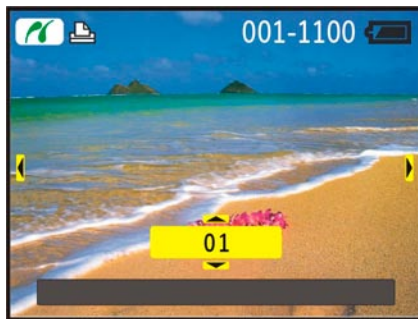

2. Use the **Left/Right** navigation buttons to scroll through the images.
3. Use the **Up/Down** navigation buttons to select the number of prints for the current

displayed image.

4. Press the  button and the following screen appears.

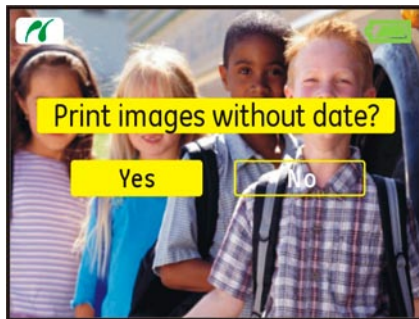

5. Select **Yes** to confirm printing, or **No** to cancel. Then press the  button.

Print index

You can use this setting to print all indexes to show all the photos currently in your camera.

1. Select **Print index** from the **PictBridge** menu. The following screen appears.



2. Select **Yes** to confirm the printing, or **No** to cancel. Then press the  button.

Print DPOF (Digital Print Order Format)

To use DPOF printing, you must make the selection of photos for printing using the DPOF settings before hand. See “DPOF” section on page 52.

1. Select **Print DPOF** from the **PictBridge** menu. The following screen appears.



2. Select **Yes** to confirm the printing, or **No** to cancel. Then press the  button.

Exit

To exit the **PictBridge** menu, select **Exit**. The “Remove USB cable” message will be displayed.

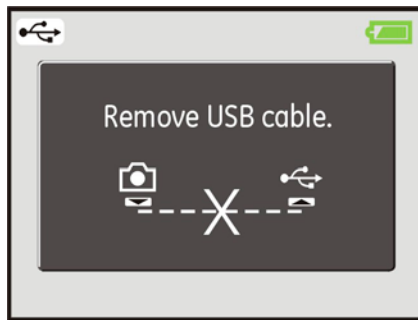

Disconnect the USB cable from the camera and printer.

Appendices

Specifications



"Design and specifications are subject to change without notice."

| | | |
|-------------------------------|---|--|
| Effective Image Sensor Pixels | 8.0 Megapixels | |
| Image Sensor | 8.5 Megapixels [1/2.5" Charge Coupled Device (CCD)] | |
| Lens | Focal Length F = | 4.67mm (Wide) ~ 23.35mm (Tele) |
| | [35mm film equivalent] | [28mm (Wide) ~ 140mm (Tele)] |
| | F number | F3.3 (Wide) ~ F5.0 (Tele) |
| | Lens Construction | 9 elements in 7 groups |
| | Optical Zoom | 5X |
| | Focusing Range | Normal: 60cm ~∞ Macro: (Wide) 6 to 60cm ; (Tele) 45 to 60cm |
| Anti-Handshake | Electronic Image Stabilization | |
| Digital Zoom | 4.5X digital zoom (Combined Zoom: 22.5X) | |

| | | |
|----------------------------|-------------|---|
| Number of Recording Pixels | Still Image | 8MP: 3264×2448,(3:2)7MP: 3264×2176, (16:9)6MP: 3264×1836, 5MP: 2560×1920, 3MP: 2048×1536, 2MP: 1600×1200, 1MP:1024×768, 0.3MP: 640×480 |
| | Movie | 640×480pixels: 30fps/15fps, 320×240pixels: 30fps/15fps |
| Image Compression | | Best, Fine, Normal |
| DCF, DPOF (Ver1.1) Support | | Yes |
| File Format | Still Image | Exif 2.2 (JPEG) |
| | Movie | Image Compression: MPEG4, Audio: G.711 [Monoaural] |
| | Audio | WAVE [Monoaural] (Max 60 seconds) |
| Shooting Modes | | Auto, Manual, Image stabilization, Movie, Scene (Sport, Children, Indoor, Leaf, Snow, Sunset, Fireworks, Glass, Museum, Landscape, Night Landscape, Night Portrait), Panorama, Portrait |
| Face-detection | | Yes |
| Red-eye Removal | | Yes |
| Panorama Stitching | | Yes |

| | |
|-------------------------|---|
| LCD Display | 3.0 inch LTPS (low-temperature polycrystalline silicon) TFT color LCD(230,400 pixels) |
| ISO Sensitivity | Auto, ISO 80/100/200/400/800/1600 (In Auto mode, the best ISO value is automatically selected.) |
| AF Method | Multi AF, Spot AF, AF Assist beam (On/Off), Face-Detection |
| Light Metering Method | Artificial Intelligence AE (Ai AE), Center-weight Average, Spot (Fixed to center of frame) |
| Exposure Control Method | ProgramAE (AE-lock available) |
| Exposure Compensation | ±2 EV in 1/3 steps |
| Shutter Speed | 4 ~ 1/2000 second (Manual 30 seconds) |
| Continuous Shooting | Approx. 1.8 fps (Large/Fine mode) |
| Playback Modes | Single Photo, Index (4/6/9 thumbnails), Slide Show, Movie (Slow-Motion possible), Zoom (Approx. 2X~8X), Audio , Histogram Display |
| White Balance Control | AWB, MWB (Daylight, Cloudy, Incandescent, Fluorescent, Fluorescent H), Manual |

| | |
|---|--|
| Internal Flash (Shooting Range) | Auto/Red-Eye Reduction/Forced Flash/No Flash/Slow Synchro/Red-Eye Reduction+Slow Synchro |
| | Gno. 6.5 (ISO 100) |
| | (Shooting Range) Wide: Approx. 0.3m~3.9m / Tele: Approx. 0.3m~2.6m (ISO 400) |
| Recording Media | Internal Memory: 26MB |
| | SD Card/SDHC Card (Up to 4GB support) |
| Other Features | PictBridge, Exif Print Support, Multi-language Support (11 languages) |
| Jacks | USB2.0/AV-OUT (Integrated Proprietary Connector), DC-IN |
| Power | Rechargeable Lithium-ion Battery GB-40, 3.7V 880mAh |
| Battery Charger | Input Voltage : AC 100 to 240V, 50/60Hz, 100mA Output Voltage : DC 4.2V, 500mA" |
| Shooting Capability (Battery Performance) | Approx. 210 shots (based on CIPA standards) |
| Operation Environment | Temperature: 0~40°C, Humidity: 0~90% |
| Dimensions (W x H x D) | 99 x 60.1 x 25.7 mm |

Error messages

| Messages | Explanation |
|-----------------------|---|
| No card | <ul style="list-style-type: none">• The memory card is not inserted. |
| Card error | <ul style="list-style-type: none">• The memory card is not formatted. (See P.57) |
| Card full | <ul style="list-style-type: none">• The memory card is full and cannot store any new images. |
| Write protect | <ul style="list-style-type: none">• The memory card is write-protected. |
| Picture error | <ul style="list-style-type: none">• The picture is not captured correctly.• The picture is damaged. |
| No picture | <ul style="list-style-type: none">• There are no images on the memory card or in the internal memory. |
| Lens error | <ul style="list-style-type: none">• The lens is probably stuck and the camera will power off automatically. |
| System error | <ul style="list-style-type: none">• Unexpected error encountered. |
| No sound file | <ul style="list-style-type: none">• There are no audio files on the memory card or in the internal memory. |
| Image cannot be saved | <ul style="list-style-type: none">• The write protection switch on the memory card is set to the "LOCK" position. |

| Messages | Explanation |
|--|--|
| Card is not formatted, format? | <ul style="list-style-type: none"> • Confirm whether the memory card should be formatted. |
| This image cannot be deleted | <ul style="list-style-type: none"> • The picture or video you are trying to delete is protected. |
| Cannot record movie | <ul style="list-style-type: none"> • The write protection switch on the memory card is set to the "LOCK" position. |
| Sound file cannot be saved | <ul style="list-style-type: none"> • The write protection switch on the memory card is set to the "LOCK" position. |
| Warning!! Camera recording, please wait. | <ul style="list-style-type: none"> • No other actions allowed to perform during video/audio recording. |
| Warning!! Battery exhausted. | <ul style="list-style-type: none"> • The battery is out of charge. |
| This file cannot be played back | <ul style="list-style-type: none"> • The picture format cannot be recognized by the camera. |
| No connection | <ul style="list-style-type: none"> • The camera is not connected to the printer correctly. |
| Print error | <ul style="list-style-type: none"> • There is a problem with camera or printer. |
| Cannot print | <ul style="list-style-type: none"> • Check that the printer is out of paper or out of ink. • Check if the printer has a paper jam. |

Troubleshooting

| Problem | Possible causes | Solution |
|---|--|---|
| Camera does not turn on. | <ul style="list-style-type: none">• The battery has run out.• The battery is not inserted correctly. | <ul style="list-style-type: none">• Charge the battery or replace with a fully charged battery.• Re-insert the battery observing the correct polarity. |
| Camera turns off suddenly during operation. | <ul style="list-style-type: none">• The battery has run out. | <ul style="list-style-type: none">• Charge the battery or replace with a fully charged battery. |
| The picture is blurred. | <ul style="list-style-type: none">• The lens is dirty.•  appears when taking pictures. | <ul style="list-style-type: none">• Use a soft cloth to clean the lens on your camera• Use the Image Stabilization mode. |
| Images, video clips, and audio files cannot be saved. | <ul style="list-style-type: none">• The memory card is full. | <ul style="list-style-type: none">• Replace the memory card with a new one.• Delete unwanted images.• Unlock the memory card. |

| Problem | Possible causes | Solution |
|---|--|--|
| No picture is taken when pressing the shutter button. | <ul style="list-style-type: none"> • The memory card is full. • No available space to store the files. • The mode dial is in Playback mode. | <ul style="list-style-type: none"> • Replace the memory card with a new one or clean off current memory card. • Delete unwanted images. • The memory card is locked. • Turn the mode dial to any still shooting mode. |
| Images cannot print from the connected printer. | <ul style="list-style-type: none"> • The camera is not connected to the printer correctly. • The printer is not PictBridge compatible. • The printer is out of paper or out of ink. • The paper is jammed. | <ul style="list-style-type: none"> • Check the connection between the camera and printer. • Use a PictBridge compatible printer. • Load some paper in the printer. • Replace the ink cartridge in the printer. • Remove the jammed paper. |

<http://www.ge.com/digitalcameras>



General Imaging Co.
2158 W. 190th Street, Torrance, CA 90504, USA
+1 (800) 730-6597

Printed in China