

# CE STATEMENT

Products with the CE Marking comply with both the EMC Directive (89/336/EEC) and the Low Voltage Directive (73/23/EEC) issued by the Commission of the European Community.

Compliance with these directives implies conformity to the following European Norms:

- EN55022 (CISPR 22) Radio Frequency Interference
- EN50082 (IEC801-2, IEC801-3, IEC801-4) Electro-magnetic Immunity
- EN60950 (IEC950) Product Safety

E

# TRADEMARK INFORMATION

- Microsoft® and Windows® are U.S. registered trademarks of Microsoft Corporation.
- Pentium® is a registered trademark of Intel Corporation.
- Macintosh is a trademark of Apple Computer, Inc.
- SD™ is a trademark.
- PhotoSuite, PhotoVista are trademarks.
- Other names and products may be trademarks or registered trademarks of their respective owners.

E

## READ THIS FIRST

Please start by reading the important messages below first.

1. The bundled driver, software, design, specifications and user's manual that were packaged with the camera are subject to change without notice.
2. The accessories that come with the camera may vary between regions.
3. For driver updates, you can contact our website "[WWW.NYTECH.DE](http://WWW.NYTECH.DE)" for help.
4. We are not liable whatsoever for any compensation arising from errors in descriptions in this user's manual.

E

## WARNINGS

**E** ⚠ Do not use the camera if it is emitting smoke, unusual odor or noise, becoming unusually hot to be touched, or if it is in any other abnormal state. Operating the camera in any of these circumstances may cause a fire or an electrical shock. Stop using the camera immediately, turn the camera off, and then disconnect the power source (batteries or AC power adapter). (If you are using the AC power adapter from the AC power outlet after you have disconnected the camera.) After checking that smoke is no longer being emitted, contact our hotline facility for repairs. Never attempt to repair this camera by yourself, as this is dangerous.

---

⚠ Do not use the camera if any foreign objects have entered the camera. Turn the camera off, remove the batteries, and then disconnect the power source (batteries or an AC power adapter.) (If you are using the AC power adapter, unplug the adapter from the AC power outlet after you have disconnected the camera.) Later on contact our hotline. Do not continue to use the camera as this may cause a fire or an electrical shock.

---

⚠ Do not place the camera in any unstable locations such as on a wobbly table or slopping surface where the camera may fall or tip over and cause damage.

---

⚠ If the camera has been dropped or if the camera case has been damaged, turn the camera off, and then disconnect the power source (batteries or AC power adapter.) (If you are using the AC power adapter, unplug the adapter from the AC power outlet after you have disconnected the camera.) Then contact to our hotline. Do not continue to use the camera as this may cause a fire or an electrical shock.

---

⚠ Do not expose the camera to moisture and avoid water gets into the camera. Take particular care when using the camera under extreme weather conditions, such as rain or snow, or when operating the camera at the beach or near water. Water in the camera may cause a fire or an electrical shock.

---

⚠ Do not touch the power plug during a thunderstorm if you are using the AC power adapter. This may cause an electrical shock.

---

E

⚠ Do not attempt to modify the camera. This may cause a fire or an electrical shock.

---

⚠ Do not remove the camera casing. This may cause an electrical shock. Internal inspection, maintenance and repairs should only be carried out by our authorized service facility.

---

⚠ Do not touch the power plug during a thunderstorm if you are using the AC power adapter. This may cause an electrical shock.

---

## CAUTIONS

- ⊗ Do not place the camera in damp or dusty locations. This may cause a fire or an electrical shock.

---

- ⊗ Do not place the camera in a location affected by oil fumes or steam, such as near a cooking stove or humidifier. This may cause a fire or an electrical shock.

---

- ⊗ Do not cover or wrap the camera or the AC power adapter with a cloth or quilt. This may cause heat to build up, distort the case and cause a fire. Always use the camera and its accessories in well-ventilated locations.

---

- ⊗ Handle the camera carefully and do not bump the camera into any hard object. Handling the camera roughly may cause a malfunction.

---

- ⊗ Do not move the camera while it is switched on. (If you are using the AC power adapter, unplug the adapter from the AC power outlet after you have switched off the camera.) Ensure that any connector cords or cables to other devices are disconnected before moving the camera. Failure to do so may damage the cords or cables and cause a fire or an electrical shock.

---

⊗ When leaving the camera unused for long periods, such as during a vacation, always unplug the camera from the power source (batteries or AC power adapter) for safety. (If you are using the AC power adapter, unplug the adapter from the AC power outlet after you have disconnected the camera.) Failure to do so could result in a fire.

---

⊗ Do not use batteries other than those specified for use with the camera. The use of unsuitable batteries may result in the batteries splitting or leaking and causing a fire, injury, or soiling of the battery compartment.

---

⊗ When fitting batteries into the camera, check the polarity markings on the battery (- and +) to ensure that you insert the battery correctly. Incorrect battery polarity may result in the batteries splitting or leaking and causing a fire, injury, or soiling of the battery compartment.

---

⊗ Remove the batteries if the camera will not be used for an extended period of time. The batteries may leak and cause a fire, injury or soiling of the battery compartment. If the batteries leak, clean and wipe the battery compartment carefully and install new batteries. Wash your hands carefully if you touch the battery fluid.

---

# CONTENTS

CE STATEMENT .....	1
TRADEMARK INFORMATION .....	2
READ THIS FIRST .....	3
<b>E</b> WARNINGS .....	4
CAUTIONS .....	6
INTRODUCTION .....	12
Overview .....	12
Package Contents .....	13
GETTING TO KNOW YOUR CAMERA .....	14
Front View .....	14
Rear View .....	15
Mode Dial .....	16
LED Indicators .....	17
LCD Monitor Information .....	18



GETTING STARTED .....	21
Installing the Batteries .....	21
Using the AC Power Adapter .....	22
Loading an SD Memory Card .....	23
Formatting the Memory Card.....	24
Attaching the Camera Strap .....	24
Attaching the Lens Strap.....	25
Choosing the Language .....	25
Setting the Date and the Time .....	26
Setting the Image Resolution and Quality .....	27
TAKING PHOTOGRAPHS .....	29
Basic Setting .....	29
Using the Viewfinder .....	29
Using the LCD Monitor .....	30
Using the Zoom Functions .....	31
Using the Self-Timer .....	32
Using the Flash .....	33

Photography in a Variety of Modes .....	35
Selecting the Manual Mode .....	36
Setting Aperture Priority.....	37
Setting Shutter Speed Priority.....	37
Selecting the Auto Mode .....	38
Selecting the Macro Mode .....	39
Selecting the Portrait Mode .....	40
Selecting the Landscape Mode .....	41
Selecting the Night Scene Mode .....	42
Selecting the Sports Mode .....	43
PLAYBACK MODE .....	44
Viewing Images .....	45
Zoom Playback .....	46
Displaying Thumbnail Images .....	47
Slide Show Display .....	48
Setting DPOF .....	49
Deleting Images/Video Clips .....	50
To Delete One Image/Video Clip At A Time .....	50
To Delete All Images/Video Clips At Once .....	51
Formatting an SD card or Internal Memory.....	52
Protecting Images/ Video Clips.....	53

MOVIE MODE .....	54
Recording Video Clips .....	54
Viewing Video Clips .....	55
TRANSFERRING RECORDED IMAGES/VIDEO CLIPS TO YOUR COMPUTER .....	56
Step 1: Installing the USB Driver on a Windows PC .....	57
Installing the USB Driver on a Macintosh Computer.....	57
Step 2: Connecting the Camera to Your Computer .....	58
Step 3: Downloading Images/Video Clips .....	59
For Computers Running Windows .....	59
For Computers Running Mac OS .....	59
INSTALLING PHOTOSUITE .....	60
INSTALLING PHOTOVISTA .....	61
MENU OPTIONS .....	62
The Capture Menu .....	62
The Playback Menu .....	70
The Setup Menu .....	72
CONNECTING THE CAMERA TO OTHER DEVICES .....	75
CAMERA SPECIFICATIONS .....	76

# INTRODUCTION

## Overview

---

**E** Your new digital camera delivers high quality, 2560 x 1920 resolution images using a 5.0 Megapixels CCD sensor. Using either the optical viewfinder or the 1.6" TFT color image LCD monitor, you can compose images and then examine them in detail. An auto-flash sensor automatically detects the shooting (lighting) conditions and determines whether the flash should be used. This feature helps ensure that your images turn out right.

SD Memory Card is a storage medium for saving images that you have photographed. Even if the camera's power is turned OFF, the images saved on the SD Memory Card are not erased. SD Memory Card can be repeatedly read and written.

In addition to still images, you can record short videos using the movie function. Images you have taken can be downloaded to your computer using the USB cable (USB driver required for Win 98 and Mac OS 8.6) You can enhance and retouch your images on your computer by using the provided editing software, or image editing software you may already own. You may share your images with your friends via e-mail, in a report, or on a website.

DPOF functionality allows you to print your images on a DPOF compatible printer by simply inserting the memory card.

## Package Contents

---

Carefully unpack your camera and ensure that you have the following items. In the event that any item is missing or if you find any mismatch or damage, promptly contact our hotline.

- Digital Camera
- User's Manual
- AC Power Adapter
- Rechargeable Batteries
- Camera Strap
- Checklist
- Lens Cover
- USB Cable
- Video Cable
- SD Memory Card
- Charger with the Instruction Manual
- Service Folder
- CD-ROM & Pouch

# GETTING TO KNOW YOUR CAMERA

## Front View

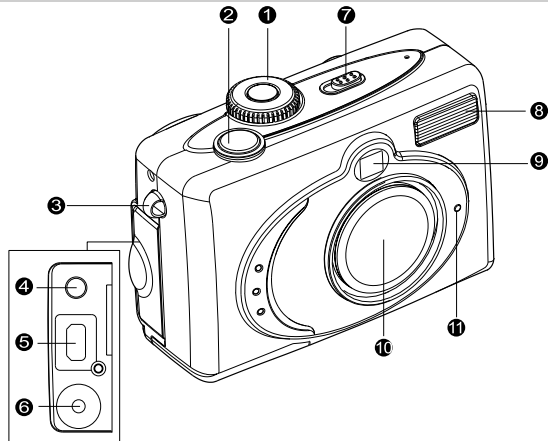

1. Mode dial

2. Shutter button

3. Camera strap/ lens strap

4. A/V OUT (Audio/Video Out) terminal

5. Digital terminal

6. DC-in connector

7. Power switch

8. Flash

9. Viewfinder window

10. Lens

11. Self-timer LED

## Rear View

1. ▲ Arrow button (Up)
- ⚡ Flash button
2. ► Arrow button (Right)
3. ▼ Arrow button (Down)
- ⏸ Self-timer button
4. ◀ Arrow button (Left)
5. **OK** OK button(Display On/Off)

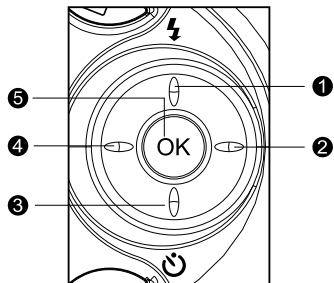

1. Viewfinder
2. LED indicator
3. LCD monitor
4. 🗑 Delete button
5. Tripod socket

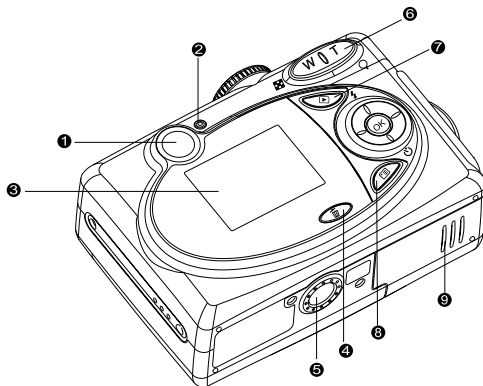

6. **T** Zoom in button
- ⊖ Digital zoom button
- W** Zoom out button
- 🖼 Thumbnail button
7. ▶ Playback button
8. ☰ Menu button
9. Battery/SD card cover

## Mode Dial

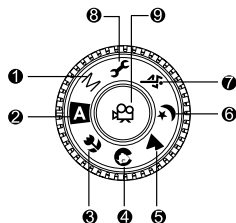

E

	Mode	Description
1.	<b>M</b> Manual Mode	This Manual mode lets you adjust additional picture settings (Color, Saturation, Sharpness)
2.	<b>A</b> Auto Mode	Select this mode to a just "point-and-shoot" action.
3.	Macro Mode	Select this mode to shoot a close-up of the subject.
4.	Portrait Mode	Select this mode to make people stand out with the background out-of-focus.
5.	Landscape Mode	This mode is used when the distance to the subject is between 0.4m and infinity.
6.	Night Scene Mode	Select this mode to take photographs of people against a dark or night-time background.
7.	Sports Mode	Select this mode to capture fast-moving subjects.
8.	Setup Mode	Select this mode to adjust the camera settings.
9.	Movie Mode	Select this mode to record video (movie) clips.



## LED Indicators

Indicator	Status	Description/Activity	Sound
LED indicator	Solid red	The camera is powering up	No
LED indicator	Solid green	The camera is powered and ready	Yes *(1)
LED indicator	Blinking red	Camera error	Yes *(3)
LED indicator	Blinking red	Charging the flash	No
LED indicator	Blinking green	Image is being recorded to the memory card	No
LED indicator	Blinking green	USB communication/transfer in progress	No
LED indicator	Solid green	The camera is ready to record images (or movies)	Yes *(1)
Self-timer indicator	Blinking red	The self-timer function is activated	Yes *(1)
----	----	Error message	Yes *(3)
----	----	Valid button event	Yes *(1)

- (1) The camera sounds one beep.
- (3) The camera sounds three beeps.

## LCD Monitor Information

These indicators are displayed when recording still images



### 1. Exposure mode

[M] Manual mode

[A] Auto mode

[🌸] Macro mode

[👤] Portrait mode

[🏔️] Landscape mode

[🌃] Night Scene mode

[🏃] Sports mode

### 2. Image size

[5M] 2560 x 1920 pixels

[2M] 1600 x 1200 pixels

[1.2M] 1280 x 960 pixels

[0.3M] 640 x 480 pixels

### 3. Image quality

[★★] Fine

[★] Normal

[★] Economy



### 4. Saturation

[📺] High





[📺] Medium

[📺] Low

## 5. Sharpness

- [  ] High
- [  ] Medium
- [  ] Low





## 6. White balance

- Auto
- [  ] Daylight
- [  ] Cloudy
- [  ] Sunset
- [  ] Tungsten
- [  ] Fluorescent



## 7. ISO

- Auto:
- 100
- 200
- 400

## 8. Flash mode

- [  ] Fill flash (on)
- [  ] Flash off
- [  ] Auto flash
- [  ] Red-eye reduction

## 9. Color



- [  ] Full color
- [  ] Black and White
- [  ] Sepia

## 10. Card indicator

E

## 11. Remaining pictures

## 12. [ ] Adapter indicator Battery level

- [  ] Full battery power
- [  ] Medium battery power
- [  ] Virtually no battery power

## 13. EV compensation

### 14. Scene mode

Normal

- [  ] Multi  
(When the scene is set as Multi, the multi icon will display on the LCD monitor)

These indicators are displayed when recording video clips:

- 1.Movie mode
- 2.Recording indicator
- 3.Video counter
- 4.Battery level
- 5.Card indicator.



**E** These indicators are displayed when playing images back:

- 1.Reverse Key
- 2.Card indicator
- 3.Forward Key
- 4.Print indicator
- 5.Current image/ total number of images
- 6.Battery level



These indicators are displayed when playing video clips back:

- 1.Reverse key
- 2.Battery level
- 3.Forward key
- 4.Current image number/ total number of images
- 5.Recorded time
- 6.Movie mode
- 7.Card indicator



# GETTING STARTED

You can use either 2 AA size batteries (Alkaline or Ni-MH) or an AC power adapter (3.0V/2.5A) to power the camera. Battery power is convenient for capturing images or recording video clips while an AC power adapter is useful when transferring images to your computer.

## Installing the Batteries

1. Make sure the camera is off.
2. Slide the battery/SD memory card cover .
3. Insert the batteries, noting correct polarity (+ and -).
4. Close the battery/SD memory card cover firmly.

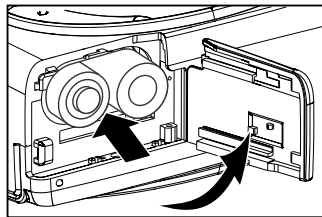

### NOTE

- If you won't be using the batteries for an extended period of time, remove them from the camera to prevent the leakage or corrosion.
- Never use manganese batteries.
- Avoid using the batteries in extremely cold environments as low temperatures may shorten the battery life and reduce the camera performance.

## Using the AC Power Adapter

1. Make sure the camera is turned off.
2. Open the port cover and connect one end of the AC power adapter to the jack labeled "DC IN".
3. Connect the other end to an electrical outlet.

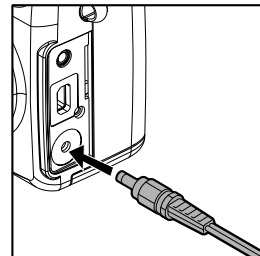

E



### NOTE

- Make sure to use only the AC power adapter specified for the camera. Damage caused by the use of an incorrect adapter is not covered under the warranty.
- To prevent unexpected auto power off resulting from no battery power left during the process of transferring your images to the computer, use the AC power adapter as a power supply.

## Loading an SD Memory Card

The camera comes with 11MB of internal memory, allowing you to store images and video clips in the camera. However, you can expand the memory capacity by using the SD memory card so that you can store additional images and video clips.

1. Make sure the camera is turned off.
2. Slide the battery/SD memory card cover .
3. Insert the SD memory card.
  - If the card cannot be inserted, check the orientation.
4. Close the battery/SD card cover.
  - To remove the SD memory card, make sure the camera is off. Open the battery/SD card cover. Press lightly on the edge of the memory card and it will eject.

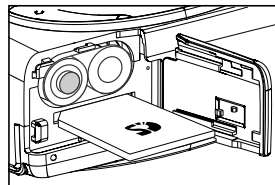

### NOTE

- To prevent valuable data from being accidentally erased from an SD memory card you can slide the write-protected tab (on the side of the SD memory card) to "LOCK".
- To save, edit or erase data on an SD memory card, you must unlock the card.

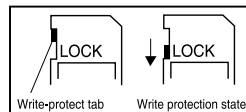

## Formatting the Memory Card

---

1. Switch to Playback mode.
2. Press the Menu button.
3. Select "Delete".
4. Select "Format card".
5. Select "Yes" to confirm your selection.  
(Caution: all data will be erased from your card).

E

## Attaching the Camera Strap

---

To prevent accidental slippage during use, always use the camera strap.

- Attach the camera strap as follows:
  1. Thread the small loop of the strap through the strap eyelet on the camera.
  2. Pull the large loop through the small loop until the strap is firmly secured

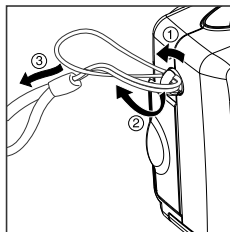



## Attaching the Lens Strap

To prevent accidental dropping of the lens cap, always use the lens strap.

■ Attach the lens strap as follows:

1. Pass the end of the lens strap through the strap eyelet on the lens cap.
  2. Pass the end through the lens strap and pull.
- \* Attach the end on the other side of the lens strap to the strap eyelet on the camera in the same way.

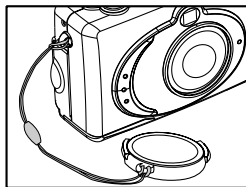

### NOTE

- To prevent the scratch and avoid dust or stains on the lens, be sure to put on the lens cap when the camera is not in use

## Choosing the Language

When you turn on the camera for the first time, the language setting screen appears, prompting you to choose a language for displayed information and the LCD monitor. Follow the steps below to set the OSD (On-Screen Display) language.

1. Select a language that you prefer by using the ▲ / ▼ button.
2. Press the **OK** button to confirm.

### NOTE

- The language setting will be retained even if the camera is turned off.
- The provided languages are [English], [Français], [Deutsch], [Español], [Italiano], [Português], and [Nederlands].



## Setting the Date and the Time

The Date/Time screen will be presented if/when:

- The camera is turned on for the first time.
- The camera is turned on after removing the batteries/AC power adapter or replacing the batteries.

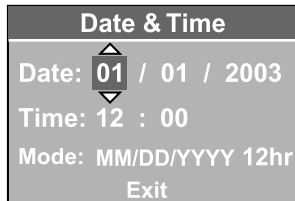

E

When the date and time setting screen appears, follow the steps to set the correct date and time. You may skip this procedure by pressing **EXIT**.





1. Enter the values of date and time by using ▲ / ▼ button.
  - To increase a value, press the ▲ button.
  - To decrease a value, press the ▼ button.
2. Press **OK** after all fields are set.

## Setting the Image Resolution and Quality

Resolution and quality settings determine the pixel size (dimension), image file size, and compression ratio for your image. These settings affect the number of images that can be stored in the internal memory, or on an SD memory card.

Higher resolution and higher quality images offer the best photographic results but take up more memory space. High resolution/quality settings are recommended for printed output and situations requiring the finest detail. Lower resolution/quality images take up less memory space and may be quite suitable for sharing images via e-mail, in a report, or on a web page.

To change the image resolution or image quality, perform the steps below:

1. Slide the **POWER** switch and power on the camera.
2. Set the mode dial base on the desired scenery (Manual, Auto, Macro, Portrait, Landscape, Night Scene or Sports).
3. Press the  button on the rear side of the camera.
4. Select Image size or Image quality by using the  /  button.
5. Press  /  to set the image size or image quality you prefer.
6. Press **OK** button to confirm.

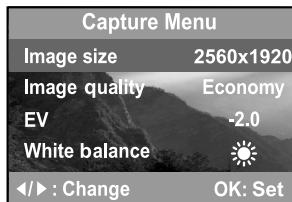

The table below shows the approximate number of shots that you can take at each setting based on 11MB internal memory or an 8MB/16MB/32MB/128MB/256MB SD memory card.

Resolution	Quality	Compression Ratio	11MB Internal Memory	8MB SD Memory Card	16MB SD Memory Card	32MB SD Memory Card	64MB SD Memory Card	128MB SD Memory Card	256MB SD Memory Card
2560x1920 <b>5M</b>	Fine	8:1	5	4	8	15	35	60	140
	Normal	12:1	7	6	13	25	50	90	210
	Economy	16:1	10	8	17	35	70	125	280
1600x1200 <b>2M</b>	Fine	8:1	12	7	14	35	75	155	320
	Normal	12:1	18	11	25	55	115	240	480
	Economy	16:1	27	15	34	72	155	310	640
1280x960 <b>1.2M</b>	Fine	8:1	20	12	25	55	120	240	500
	Normal	12:1	30	18	38	85	180	370	740
	Economy	16:1	40	25	52	110	240	500	1000
640x480 <b>0.3M</b>	Fine	8:1	60	32	68	150	310	650	1350
	Normal	12:1	90	50	105	225	460	1000	2000
	Economy	16:1	120	66	140	300	620	1300	2650

- The above data shows the standard testing results. The actual capacity varies according to the shooting conditions and settings.

# TAKING PHOTOGRAPHS

## Basic Setting

Your camera is equipped with both an optical viewfinder and a 1.6" full color TFT LCD monitor to compose images. Taking images by using the optical viewfinder will conserve more battery power. If your batteries' level is in low condition, it is recommended to compose images by using the viewfinder. The LCD monitor can help you accurately compose the pictures and examine all the details, but using it may also consume more battery power. However, always use the LCD monitor for **MACRO** shots to avoid parallax effects.

E

## Using the Viewfinder

Using the viewfinder helps you to compose images and adjust the subject in the crisp focus.

1. Turn the camera on by sliding the **POWER** switch.
2. Set the mode dial base on the desired scenery (Manual, Auto, Macro, Portrait, Landscape, Night Scene or Sports).
3. Compose your picture in the viewfinder.
4. Press the shutter button.
  - The LED indicator blinks green while the camera is processing a captured image.

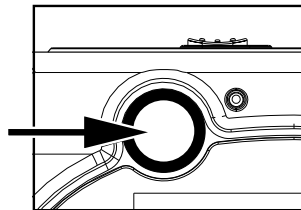

## Using the LCD Monitor

Using the LCD monitor can help you to confirm an image while taking pictures, to replay recorded images/video clips or to adjust menu settings. The mode icons, text and numbers that are displayed on the LCD monitor may vary according to the current settings.

1. Turn the camera on by sliding the **POWER** switch.
2. Set the mode dial base on the desired scenery (Manual, Auto, Macro, Portrait, Landscape, Night Scene or Sports).
3. Compose your shot in the LCD monitor.
4. Press the shutter button.
  - The LED indicator blinks green while the camera is processing a captured image.

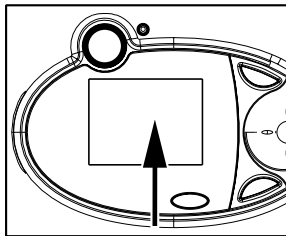

### NOTE

- In Capture mode, each press of the **OK** button switches the display state as LCD On/ Non-Information Display/ LCD Off.
- The LCD monitor darkens in strong sunlight or bright light. This is not a malfunction.
- Using the LCD monitor for an extended period of time will decrease the number of images you can take. To conserve battery power and increase the number of shots you can take, it is recommended to turn the LCD monitor off and use the viewfinder instead.
- Always use the LCD monitor for **MACRO** shots.
- In [  ] Movie mode, the LCD monitor cannot be turned off.

## Using the Zoom Functions

The lens moves during the zoom photography. Zoom photography allows you to capture telephoto and wide-angle shots. By using the digital zoom, images can be closer by pressing the (T) telephoto button. Or appears smaller away by pressing the (W) wide-angle button.

To capture a digitally zoomed image, perform the following steps:

1. Turn the camera on by sliding the **POWER** switch.
2. Set the mode dial base on the desired scenery (Manual, Auto, Macro, Portrait, Landscape, Night Scene or Sports).
3. Press **T** button to activate the zoom function.
  - Digital zoom's range is from 1.25x to 4x (within 11 stages: 1.25x, 1.5x, 1.67x, 1.75x, 2x, 2.25x, 2.5x, 3x, 3.33x, 3.5x and 4x).
  - To exit the digital zoom, press continuously the **W** button and return to the optical zoom status.
4. Press the shutter button to capture a "zoomed" image.

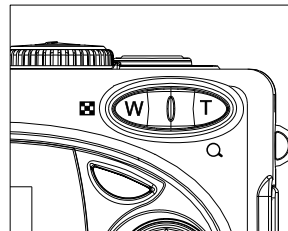

E

### NOTE

- Digital zoom can only be functioned with the maximum image size (resolution) of 2560 x 1920 pixels. Digital zoom is not available with other image size (resolution).
- In Capture mode, zoom key is always active to zoom the lens between wide-angle and telephoto shots.
- Digital zoom cannot be used in [  ] Movie mode.

## Using the Self-Timer

By using the self-timer you can join into the screen when taking group shots. You can take pictures with the self-timer in any shooting mode (Manual, Auto, Macro, Portrait, Landscape, Night Scene or Sports).

The self-timer duration can be adjusted as 10 seconds or 5 seconds. The mode appears cyclically as [10 s]->[5 s]->[Display Off]. After the self-timer is set, the shutter automatically releases after 10 or 5 seconds. When the self-timer is set as 10 seconds or 5 seconds, the self-timer lamp starts blinking relatively slow for the first 7 or the first 2 seconds and then blinking rapidly for the last 3 seconds.

E

1. Secure the camera to a tripod or place it on a stable surface.
2. Turn the camera on by sliding the **POWER** switch.
3. Set the mode dial base on the desired scenery (Manual, Auto, Macro, Portrait, Landscape, Night Scene or Sports).
4. Compose the picture.
5. Press the  button.



■ The count down is displayed on the LCD monitor.

6. Press the shutter button.

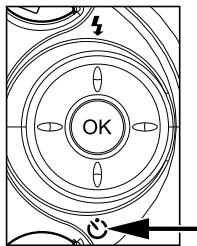
■ To cancel the self-timer photography at any time, press the self-timer button to disrupt the sequence.



### NOTE

- In Capture mode, pressing the  button will set self-timer ON.
- After one shot is taken, the self-timer mode is turned to OFF.
- In self-timer mode, rotating the mode dial will change into Capture mode.
- In self-timer mode, pressing [] or [] will change into Capture mode.



## Using the Flash

The flash is designed to function automatically when lighting conditions warrant the use of flash. You can take an image using a suitable flash mode to your circumstances. If you change the flash mode, the camera will retain that setting even if the camera is turned off.



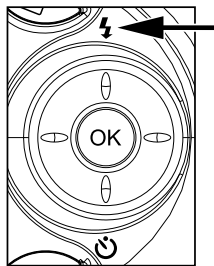

1. Turn the camera on by sliding the **POWER** switch.
2. Set the mode dial base on the desired scenery (Manual, Auto, Macro, Portrait, Landscape, Night Scene or Sports).
3. Press the  button located on the rear side of the camera repeatedly until your desired flash mode appears on the LCD monitor.
4. Compose the picture and press the shutter button.



E

The camera has four flash modes: Auto Flash (default), Red-Eye Reduction, Fill Flash (on), and Flash Off. The modes appear cyclically when you press the  button on the rear side of the camera.



The table below will help to choose the appropriate flash mode:

Flash Mode	Description
[  ] Auto Flash	The flash fires automatically according to the ambient lighting conditions. Select this mode for general photography.
[  ] Red-Eye Reduction	The flash emits a precursor-flash before the main flash fires. This causes the pupil in the human eye to constrict, reducing the red-eye phenomenon. Select this mode when taking images of people and animals in low-light conditions.
[  ] Fill Flash (on)	The flash will always fire regardless of the surrounding brightness. Select this mode for recording images with high contrast (backlighting ) and deep shadows.
[  ] Flash Off	The flash will not fire. Select this mode when taking images in a place where flash photography is prohibited, or when the distance to the subject is beyond the effective range of the flash.

E







## NOTE

- In [  ] Macro mode, flash photography is not possible.
- In [  ] Night Scene mode, flash photography is fixed to Fill Flash (on).

## Photography in a Variety of Modes

Your digital camera offers you choices of seven "scenes", which include Manual mode, Auto mode, Macro mode, Portrait mode, Landscape mode, Night Scene mode and Sports mode. In these modes, your camera setting can automatically be optimized for the selected subject's type, sparing you the requisites of settings adjustment one-by-one.

Scene Mode	Description
[ M ] Manual Mode	This mode is used to adjust user's preferring conditions.
[ A ] Auto Mode	This mode is used to simplify capturing procedures.
[  ] Macro Mode	This mode is used to shoot a close-up of the subject, such as flowers or insects.
[  ] Portrait Mode	This mode is used to make the main subject stands out precisely while the background details are out-of-focus.
[  ] Landscape Mode	This mode is used to enhance color, saturation shown in sky-scapes, mountains, forests and other landscape scenery, or to take portraits that feature a landmark in the background.
[  ] Night Scene Mode	This mode is used to capture human subjects against a dusk or night-time background.
[  ] Sports Mode	This mode is used to capture the fast moving subjects.







### NOTE

- In Capture mode, each press of the **OK** button switches the display state as LCD On/ Non-Information Display/ LCD Off.

## Selecting the Manual Mode

You can capture images by manually adjusting conditions such as image size, image quality, EV compensation, white balance, 16-images, quick view, ISO speed, image color, image saturation and image sharpness. For the above setting information, refer to the capture menu.

1. Turn the camera on by sliding the **POWER** switch.
2. Rotate the mode dial to **[M]**.
3. Press the  Menu button.
4. To set Image size, Image quality, EV, White balance, Scene, Quick view, ISO, Color, Saturation and Sharpness you may press  /  button or press  /  button to enter the sub-menu and choose the setting with you preference. After the settings are all set, press the **OK** button to confirm.
5. Compose the picture.
6. Press the shutter button down halfway to focus the image, then press it fully down.

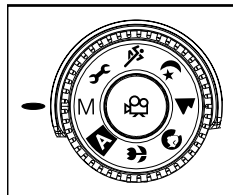

### Setting Aperture Priority

In **[M]** Manual mode, you can manually set the aperture priority and shutter speed to achieve a particular effect.

In **[M]** Manual mode, images are taken with the priority given to the aperture setting. The shutter speed is automatically set according to the aperture.

In **[M]** Manual mode, press **▶** button can adjust aperture priority.



#### NOTE

---

- The setting range is from F2.8/F3.2/F3.6/F.4.0/F4.5/F.5.0/F5.6/F6.3/F7.1 to F8.0.

### Setting Shutter Speed Priority

In **[M]** Manual mode, images are taken with the priority given to the shutter speed. The aperture is automatically set according to the shutter speed. If you set a fast shutter speed, you can take images of moving subjects that look they are still. If you set a slow shutter speed, you can take images that make you feel as if the subject is rushing by.

In **[M]** Manual mode, press **◀** button can adjust aperture priority.



#### NOTE

---

- The setting range is from 1/5, 1/8, 1/15, 1/30, 1/60, 1/125, 1/250, 1/500, 1/1000 to 1/2000.

## Selecting the Auto Mode

In this mode the majority of the settings are adjusted by the camera. Simply point the camera at the subject and then shoot.

1. Turn the camera on by sliding the **POWER** switch.
2. Rotate the mode dial to [ **A** ].
3. Press the  Menu button.
4. To set Image size, Image quality, EV, White balance, Scene, Quick view and ISO you may press ◀ / ▶ button or press ▲ / ▼ button to enter the sub-menu and choose the setting with you preference. After the settings are all set, press the **OK** button to confirm.
5. Compose the picture.
6. Press the shutter button down halfway to focus the image, then press it fully down

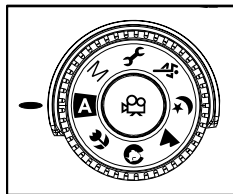







### NOTE

---

- In [A] Auto mode, Color, Saturation and Sharpness settings cannot be adjusted manually.

## Selecting the Macro Mode

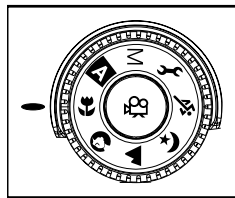

Use the macro mode to capture a close-up of the subject, such as flowers or insects. The effective range is between 0.2m and 0.7m.

1. Turn the camera on by sliding the **POWER** switch.
2. Rotate the mode dial to [  ].
3. Press the  Menu button.
4. To set Image size, Image quality, EV, White balance, Scene, Quick view, Color, Saturation and Sharpness you may press  /  button or press  /  button to enter the sub-menu and choose the setting with you preference. After the settings are all set, press the **OK** button to confirm.
5. Compose the picture.
6. Press the shutter button down halfway to focus the image, then press it fully down.









E

### NOTE

- When shooting a close-up in [  ] Macro mode, use the image LCD monitor to compose your shot, avoiding the off-center parallax phenomenon.
- After a macro shot is taken DO NOT FORGET to reset the lens to the normal status.
- In [  ] Macro mode, the internal flash cannot be used.
- In [  ] Macro mode, ISO speed cannot be set.



## Selecting the Portrait Mode

Taking pictures by selecting the [  ] Portrait mode helps you to construct portraits in which the main subject stands out sharply and clearly against indistinct background's details. The effective range is between 0.4m and infinity.

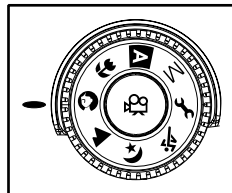
1. Turn the camera on by sliding the **POWER** switch.
2. Rotate the mode dial to [  ].
3. Press the  Menu button.
4. To set Image size, Image quality, EV, White balance, Scene, Quick view, Color, Saturation and Sharpness you may press  /  button or press  /  button to enter the sub-menu and choose the setting with you preference. After the settings are all set, press the **OK** button to confirm.
5. Compose the picture.
6. Press the shutter button down halfway to focus the image, then press it fully down.



### NOTE

- In [  ] Portrait mode, ISO speed settings cannot be set.
- In [  ] Portrait mode, in a dusk or night-time background, the Flash mode defaults to [  ] (automatically set to Red-Eye Reduction).



## Selecting the Landscape Mode

Taking pictures by selecting the [ ▲ ] Landscape mode helps you to capture vivid and expansive landscape pictures with the enhancement of image's color and saturation. The [ ▲ ] Landscape mode is used when the distance to the subject is between 0.4m and infinity.

1. Turn the camera on by sliding the **POWER** switch.
2. Rotate the mode dial to [ ▲ ].
3. Press the  Menu button.
4. To set Image size, Image quality, EV, White balance, Scene, Quick view, Color, Saturation and Sharpness you may press ◀ / ▶ button or press ▲ / ▼ button to enter the sub-menu and choose the setting with you preference. After the settings are all set, press the **OK** button to confirm.
5. Compose the picture.
6. Press the shutter button down halfway to focus the image, then press it fully down.

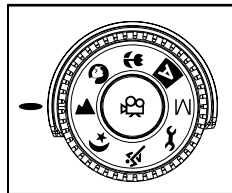

E







### NOTE

- In [ ▲ ] Landscape mode, ISO speed cannot be set and Flash mode defaults to [  ] Flash Off

## Selecting the Night Scene Mode



Capturing human subjects by using the [  ] Night Scene mode helps to provide a natural balance between the main subject and the background. The people in an evening sky or night scene are illuminated with lights from the flash while the background is captured at a slow shutter speed to prevent blurring and let both (people and the background) appear accordingly exposure.

E

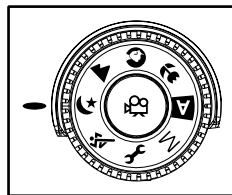
1. Turn the camera on by sliding the **POWER** switch.
2. Rotate the mode dial to [  ] .
3. Press the  Menu button.
4. To set Image size, Image quality, EV, White balance, Scene, Quick view, Color, Saturation and Sharpness you may press  /  button or press  /  button to enter the sub-menu and choose the setting with you preference. After the settings are all set, press the **OK** button to confirm.
5. Compose the picture.
6. Press the shutter button down halfway to focus the image, then press it fully down.









### NOTE

- In [  ] Night Scene mode, Flash mode defaults to [  ] (automatically set to flash on).
- In [  ] Night Scened mode, ISO speed cannot be set.

## Selecting the Sports Mode

Using the [  ] Sports mode helps you to capture fast-moving objects.

1. Turn the camera on by sliding the **POWER** switch.
2. Rotate the mode dial to [  ].
3. Press the  Menu button.
4. To set Image size, Image quality, EV, White balance, Scene, Quick view, Color, Saturation and Sharpness you may press  /  button or press  /  button to enter the sub-menu and choose the setting with you preference. After the settings are all set, press the **OK** button to confirm.
5. Compose the picture.
6. Press the shutter button down halfway to focus the image, then press it fully down.

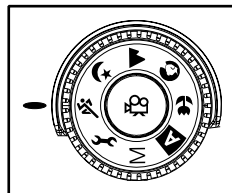

E



### NOTE

---

- In [  ] Sports mode, ISO speed cannot be set.

# PLAYBACK MODE

In  mode, you can view, magnify, delete, protect images, play video clips, or run a slide show. Playback mode also provides a thumbnail image display, allowing you to quickly scan for the image you want. You can also change the size or quality(resolution) of images which is handy when you utilize an image as a mail attachment, for example.



## NOTE







---

E

- In Playback mode, pressing the  Playback button or rotating the mode dial will change into Capture mode.
- In Playback mode, pressing the shutter button will change into Capture mode and automatically take the current image .

## Viewing Images

You may view your recorded images on the LCD monitor by pressing the  button.

1. Turn the camera on by sliding the **POWER** switch.
2. Press the  button, then press the menu button and the playback menu displays on the screen.
3. View and select your recorded images by using the  /  button.
  - To view the previous image, press the  button.
  - To view the next image, press the  button.
  - Through the LCD monitor, the screen also displays the detailed information of the captured image, such as print indicator, current number of the image, total number of the images and the battery level.
  - When playing back images you may also display image information. Press the **OK** button, the detailed image information is displayed.
  - The print icon only appears on the LCD monitor when the image is set to print out.
  - The recorded time only appears on the LCD monitor, when it is recoded by using [  ] movie mode.

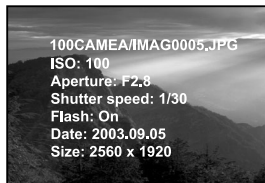

### NOTE



- If there is no image stored in the internal memory or the memory card, an indication of "No Image " will appear on the LCD monitor.
- You can also view your images on TV screen. Connect one end of the video cable to the video out jack of the camera and connect the other end to the video input of your input of your TV. Press the  button and then turn on TV or camera.

## Zoom Playback

---

While reviewing your images, you may enlarge a selected portion of an image. This magnification allows you to view fine details.

E

1. Turn the camera on by sliding the **POWER** switch.
2. Press the  button.
3. View and select your recorded images by using the  /  button.
4. To zoomed the image press the **[T]** button.
  - Digital zoom in the playback mode can magnify up to 6x.
5. To return to the regular display from 6x status, keep pressing the **[W]** button and will change into thumbnail images.









### NOTE

---

- When you zoomed the maximum portion of the selected image, the  /  /  /  key will be disappeared.

## Displaying Thumbnail Images

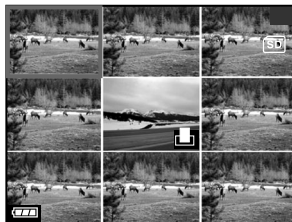

This function allows you to view nine thumbnail images on the LCD monitor simultaneously so that you can quickly scan for a particular image.

1. Turn the camera on by sliding the **POWER** switch.
2. Press the button  and then the  button.
  - Nine thumbnail images appear on the LCD monitor (assuming there are nine or more recorded images in the memory).
  - To view a full-size image, press [T] the telephoto or **OK** button after the image selection by using the  /  /  /  button.



E

### NOTE



- While displaying thumbnail images, pressing the  delete button the current chosen image will be deleted.
- While displaying thumbnail images, by pressing the  playback button, the screen will change to Capture mode and ready to take next shot.

## Slide Show Display

---

The slide show function enables you to play your images back automatically sequential order as a slide show. This is a very useful and entertaining feature reviewing recorded images, video clips and for presentations.

E

1. Turn the camera on by sliding the **POWER** switch.
2. Press the  Playback button.
3. Then press the  Menu button and select **Slide show** by using **▲** / **▼** button.
4. Press the **OK** button and to set the playback interval by using **▲** / **▼** button.
5. And then press the **OK** button again to confirm as your preference.
  - The slide show starts, displaying your images on the LCD monitor one by one with the interval.
  - To stop the slide show display, press the **OK** button or rotate the mode dial.

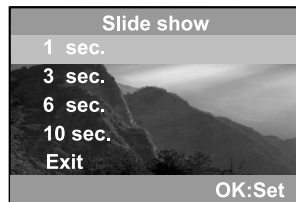

### NOTE

---



- You can adjust the slide show display interval within the range of 1 sec. to 10 sec. (1 sec. / 3 sec. / 6 sec. / 10 sec.)
- To not set on the slide show display you may choose **Exit**. The slide show display defaults to 1 sec. intervals.



## Setting DPOF

DPOF (Digital Print Order Format) allows you to embed printing information on your memory card. By using DPOF, you can select an image to be printed and then specify how many prints or which image you would like. Take your memory card to a DPOF enabled printer that accept memory cards. The DPOF/card-compatible printer will read the embedded information on the memory card and print your images as specified.

### To set DPOF:

1. Turn the camera on by sliding the **POWER** switch.
2. Press the  Playback button.
3. Then press the  Menu button and select **DPOF** by using the **▲ / ▼** button.
4. Choose the option you prefer by using the **▲ / ▼** button and then press the **◀ / ▶** button to select quantity or image.
  - The DPOF icon will appear on the DPOF-setting image.

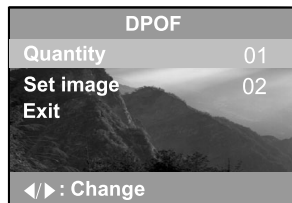

### The DPOF menu options:

[Quantity]: select the image quantity from 0~9

[Set image]: allows you to select your preference image

[Exit]: to exit the screen .





### NOTE

- To print images from the internal memory, it is necessary to copy your images to the SD memory card first.
- The  print icon will also display on the LCD monitor to indicate images selected for printing.

## Deleting Images/Video Clips



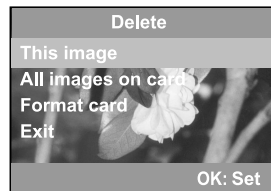
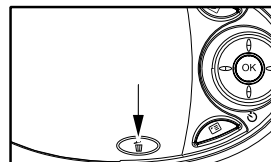

To delete one image or video clip at a time, use the  button on the rear side of the camera. To delete all images or video clips at once, you may find this option in Playback menu.

### ■ To Delete One Image/Video Clip At A Time

1. Turn the camera on by sliding the **POWER** switch.
2. Press the  button on the rear side of the camera to see the captured images and video clips.
3. Select the unwanted image/video clip by using the  /  button and then press the  button.
4. Continue the deletion if necessary.
  - If all images are deleted, [No Image] will pop up.
5. To exit this screen, rotate the mode dial.



## ■ To Delete All Images/Video Clips At Once

1. Turn the camera on by sliding the **POWER** switch.
2. Press the  button on the rear side of the camera to see the captured images and video clips.
3. Then press the  button.
4. Select **Delete** by using the **▲ / ▼** button.
5. Press the **OK** button and then select [All images on card] by using the **▲ / ▼** button.
6. Press the **OK** button again to confirm.
  - After that, [No Image] pops up. To exit the screen, press the  playback button,  menu button, or rotate the mode dial. The camera is ready to take the next image now or video clip.

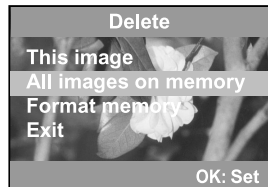
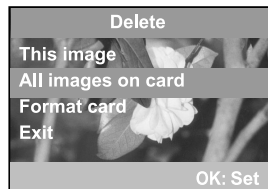

E

## NOTE

- To delete the images or video clips stored in the internal memory, the steps are the same as mentioned above. Be sure to remove the SD memory card first and the OSD screen will display as "All images on memory".
- The OSD message for deleting all images or video clips will display as "All images on card" or "All images on memory" base on your decision whether to delete information recorded in the card or in the internal memory.

## Formatting an SD card or Internal Memory

Using this option you may format the internal memory or the SD memory card.

To perform the format function, press the ▲ / ▼ and then press **OK**.

E

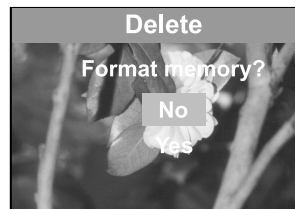
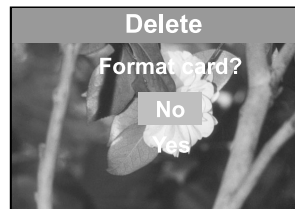



### NOTE

- To format the images or video clips stored in the internal memory, be sure to remove the SD card memory card first and the OSD screen will display as "Format memory?".

## Protecting Images/ Video Clips

You can protect one image/video clip or all images/video clips from being accidentally erased by using the protect function in the Playback menu.

### Protecting one image/video clip or all images/video clips

1. Turn the camera on by sliding the **POWER** switch.
2. Press the  button and then the  Menu button.
3. Select [Protect One] or [Protect All] by pressing **▲ / ▼** button.
4. Select [Lock] by pressing **▲ / ▼** button and then press **OK**.
  - To protect [one image], you may also press **◀ / ▶** button to set the setting.
  - Once the image/video clip is protected, the protection icon will display on the protected image/video clip.

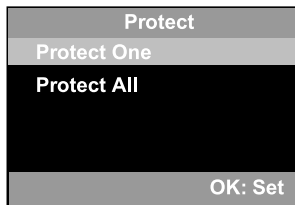

### Removing protection from one image/ video clip or all images/ video clips



1. Perform the steps above 1 to 3 in "Protecting one image/video clip or all images/video clips".
2. Select [Unlock] by pressing the **▲ / ▼** button and then press **OK**.
  - To unlock [one image], you may also press **◀ / ▶** button to set the setting.

# Movie Mode

## Recording Video Clips

The movie mode allows you to record video clips at a resolution of 320 x 240 pixels. Voice can also be recorded.

E

1. Turn the camera on by sliding the **POWER** switch.
2. Press the  button.
  - The recording movie time, REC icon, the card indicator and the battery level will all display on the LCD monitor.
3. You can start recording the video clip simply by pressing the  button.
  - To stop the recording, press the  button.









### NOTE

- It is not possible to zoom in or zoom out while in the  Movie mode.
- In movie mode, image size, image quality and self-timer's functions cannot be set or activated.
- In movie mode, the flash mode is automatically set to OFF.
- You can set image quality in the Capture menu before recording a video clip.

## Viewing Video Clips

To view the recorded video clips, follow the steps below.

1. Turn the camera on by sliding the **POWER** switch.
2. Press the  button.
3. View and select your recorded video clips by using the  /  button.
  - While playing back the video clips, within 2 seconds, the camera will automatically play the whole movie recording again.
  - While viewing the video clips, the  /  keys, the current image, recorded time will also indicated on the LCD monitor.
  - While playing back the video clip, press the **OK** button within 3 seconds, the "recorded date" will automatically display on the screen.
  - To stop or start playback, press the **OK** button.
  - To exit playback, press the  playback button or rotate the mode dial. Then the camera is ready to take the next shot or video clip.

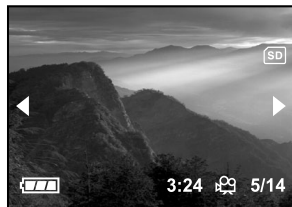

E

### NOTE

- The zoom function cannot be activated while playing back the video clips.
- When playing back the video clips, the screen will also count down the recorded time.
- When playing back video clips on TV, recorded voice can be also played out.

# TRANSFERRING RECORDED IMAGES/VIDEO CLIPS TO YOUR COMPUTER

You can share recorded images/ video clips with your family or friends via e-mail or post them on the Web. Before doing those things, you need to connect the camera to your computer by using the USB cable and then transfer the images/video clips.

To transfer images/video clips from the camera to your computer, follow the steps below:

**Step 1:** Installing the USB driver

**E Step 2:** Connecting the camera to your computer

**Step 3:** Downloading images/video clips

	<b>System Requirements (Windows)</b>	<b>System Requirements (Macintosh)</b>
CPU	Pentium 166 MHz processor or higher	PowerPC G3/G4
OS	Windows 98/98SE/Me/2000/XP	OS 8.6 or higher
Memory Free Space	32MB (64MB RAM recommended)	32MB (64MB RAM recommended)
on Hard Disk	128 MB hard disk space	128 MB hard disk space
Required Devices	A CD-ROM Drive, An Available USB Port	A CD-ROM Drive, An Available USB Port
Color Monitor	Color Monitor (800x600, 24-bit or higher recommended)	Color Monitor (800x600, 24-bit or higher recommended)



## Step 1: Installing the USB Driver on a Windows PC

The USB driver on the supplied CD-ROM is exclusively for Windows 98. Installing the USB driver on computers running **Windows 2000/Me/XP** is not necessary.

1. Insert the CD-ROM packaged with the camera into the CD-ROM drive. The welcome screen appears.
2. Click "Install USB Driver". Follow the on-screen instructions to complete the installation. After the USB driver installation is complete, restart your computer.

E

### Installing the USB Driver on a Macintosh Computer

Mac OS 8.6 users must install a USB driver. For Mac OS 9.0 or higher version, the computer will automatically recognize the camera and load its own USB drivers.

1. Insert the CD-ROM that packaged with the camera into your CD-ROM drive.
2. Select and double-click "Digital Camera Driver Installer".
3. Select "Install Location" and click "Install".
4. Follow the on-screen instructions to complete the installation and restart your computer.

## Step 2: Connecting the Camera to Your Computer

1. Connect one end of the USB cable to an available USB port on your computer.
2. Connect the other end of the USB cable to the USB connector on the camera.
3. Turn the camera on.
4. Look for a new "Removable Disk" icon appearing in the "My Computer" window. Your recorded images/video clips will be in a folder on this "removable disk". (For Mac users, double-click the "untitled" disk on the desktop.)

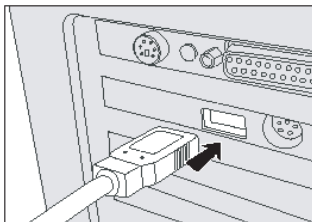

### Step 3: Downloading Images/Video Clips

---

When the camera is turned on and connected to your computer, it is considered to be a disk drive, just like a floppy disk or CD. You can download (transfer) images by copying them from the "removable disk" ("untitled" disk on a Macintosh) to your computer hard drive.

#### For Computers Running Windows

Open the "removable disk" by double clicking on it. Double click on the folder contains your recorded images/video clips. Select the images/video clips that you prefer and then choose "Copy" from the "Edit" menu. After that, open the destination location and choose "Paste" from the "Edit" menu.

E

#### For Computers Running Mac OS

Open the "untitled" disk window and the hard disk or the destination location. Drag and drop from the camera disk to the desired destination.



#### NOTE

---

- It is recommended that you use the AC power adapter as a power supply for the camera while transferring your images/video clips from the camera to your computer to avoid the camera maybe cut off unexpectedly when the batteries run out.
- Memory card users may prefer to use a memory card reader (highly recommended).

# INSTALLING PHOTOSUITE

PhotoSuite is a very user-friendly image-editing program. With PhotoSuite, you can breezily retouch, compose and organize your images. It contains a variety of templates, such as photo frames, birthday cards, calendars and more. Get your images ready and go explore this amazing program.

To Install PhotoSuite

1. Insert the CD-ROM packaged with the camera into the CD-ROM drive. The welcome screen appears.
2. Click "Install PhotoSuite". Follow the on-screen instructions to complete the installation.



## NOTE

- For information on how to use PhotoSuite to edit and retouch your recorded images, please refer to its online help.
- For Windows 2000/XP users, make sure to install and use the PhotoSuite while logged in as a user with an Administrator account.
- PhotoSuite is not supported on the Mac.

# INSTALLING PHOTOVISTA

PhotoVista is an easy-to-use program that lets you create spectacular 360° panoramic images in a snap. When you view these panoramas, you get the experience of being totally immersed in a realistic environment. PhotoVista's powerful engine quickly and automatically stitches images together, and its intuitive interface will let even a novice get great results in minutes.

To Install PhotoVista:

1. Insert the CD-ROM packaged with the camera into the CD-ROM drive. The welcome screen appears.
2. Click "Install PhotoVista". Follow the on-screen instructions to complete the installation.



## NOTE





- For information on how to use PhotoVista to create spectacular 360° panoramic images, please refer to its online help.
- For Windows 2000/XP users, make sure to install and use the PhotoVista while logged in as a user with an Administrator account.
- For Windows XP users which OS version does not include Service Pack 1 or higher, make be sure to link to <http://java.sun.com/getjava/download.html> first and download the Java Virtual Machine. For more detail information about Java, please refer to its on-line help at <http://java.sun.com/getjava/help.html>. After java software installation, you can start to install iSee Media Photovista Panorama. Hereunder is iSee Media Photovista Panorama System Requirements and Recommendations:
  - \* Windows 95, Windows 98, Windows NT 4 (Service Pack 3 or higher)
  - \* Windows 2000\*, Windows ME\*, Windows XP\* (Service Pack 1 or higher)
- PhotoVista is not supported on the Mac

# MENU OPTIONS

## The Capture Menu

In the Capture menu, you can determine the conditions you would like to choose such as image size, image quality, EV compensation, white balance, scene, quick view, ISO, color, saturation and sharpness.

E

1. Turn the camera on by sliding the **POWER** switch.
2. Set the mode dial base on the desired scenery (Manual, Auto, Macro, Portrait, Landscape, Night Scene or Sports).
3. Press the  button and then scroll through the options by pressing the  /  button.
4. After setting your preferences in the capture menu, press  or rotate the mode dial to go back to Capture mode.

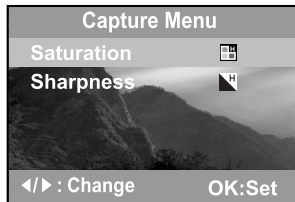
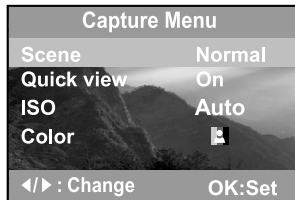
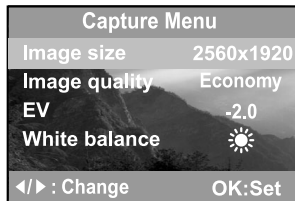

## Image size

Refer to “Setting the Image Resolution and Quality” (p. 27).

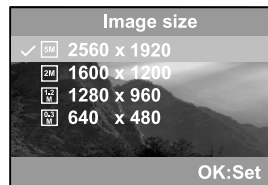

## Image quality

Refer to “Setting the Image Resolution and Quality” (p. 27).

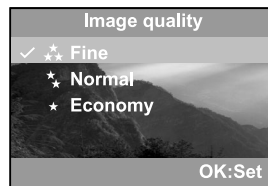

## EV

Your camera adjusts the exposure for each scene automatically. However, when the subject is too dark or too bright, the camera adjusts the brightness or darkness. This is called EV compensation. The EV compensation of your camera can be adjusted from [-2.0 EV] to [+2.0 EV] (0.5 EV step).

To select the EV compensation you wish, first press the **OK** button. Then increase or decrease the EV compensation depending on what you need by using the **▲ / ▼** button and then press the **OK** button again to confirm.

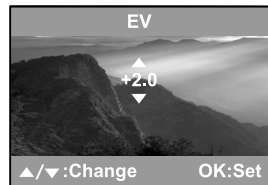

## Effective Subjects and Set Values

### Positive (+) Compensation

- Copying of printed text (black characters on white paper)
- Backlit portraits
- Very bright scenes (such as snowfields) and highly reflective subjects
- Shots made up predominantly of sky

E

### Negative (-) Compensation

- Spot lighted subjects, particularly against dark backgrounds
- Imaging of printed text (white characters on black paper)
- Scenes with low reflectivity, such as shots of green or dark foliage



## White balance

When the brightness of the light changes, our eyes adapt the difference so that the white object remains white. For digital still cameras, they can also see the white object as white by averaging the light around the subject.

The camera determines the white balance by averaging the various kinds of light that actually enters the lens. You may set in advance the white balance when taking photographs under specific lighting conditions (Auto, Daylight, Cloudy, Sunset, Tungsten and Fluorescent).

To set the white balance, first press the **OK** button. Then choose the appropriate white balance setting you prefer by pressing the **▲ / ▼** button and then press the **OK** button again to confirm.

[**Auto**]: automatically adjusting the white balance

[☀️ Daylight]: for recording outdoors on a bright day

[☁️ Cloudy]: recording for overcast, shaded, twilight or evening skies

[🌅 Sunset]: for recording under sunset.

[💡 Tungsten]: for recording under tungsten lighting condition

[💡 Fluorescent]: for recording under fluorescent lighting condition

## ISO

The ISO speed decides the sensitivity to the lights. The higher the ISO number is, the more sensitive it is to the lights.

When recording under dark situations or recording a fast moving, use a high-number setting. However, while recording high quality images, we suggest you to use a low-number setting.

To set the ISO speed, first press the **OK** button. Then choose the appropriate ISO speed by pressing the ▲ / ▼ button and then press the **OK** button again to confirm.

E

[Auto]: adjusts the ISO speed automatically

[100]: equivalent to ISO 100





[200]: high-sensitive photography, equivalent to ISO 200

[400]: high-sensitive photography, equivalent to ISO 400



## NOTE

---

- In [  ] Macro mode, [  ] Portrait mode, [  ] Night Scene mode, [  ] Landscape mode and [  ] Sports mode, the ISO speed setting is not possible.

## Scene

Set the scene to photograph such as Normal or Multi.

[Normal]: Take one image at a time.

[Multi]: 16 photographs are taken continuously at 1.6 sec. to 2 sec. (10 frames/ second). This feature is effective for taking moving subjects continuously.

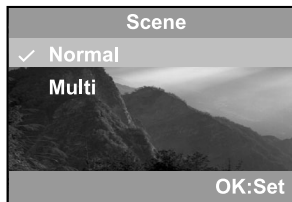

E

## NOTE

- Flash mode cannot be used.

## Quick view

Set to display immediately a photographed image on LCD monitor.

[On]: Display the quick view.

[Off]: Do not display the quick view.

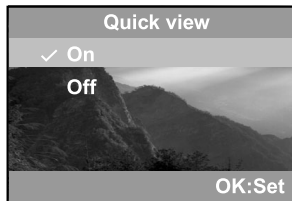

## Color

To capture an image, the camera offers three types of color (Full Color/ Black & White/ Sepia) for you to match as your wish. Your images will demonstrate different impression by choosing different types of color.

To set the color, first press the **OK** button. Then choose the appropriate color background Full (Color/Black & White/Sepia) you prefer by pressing the ▲ / ▼ button and then press the **OK** button again to confirm.

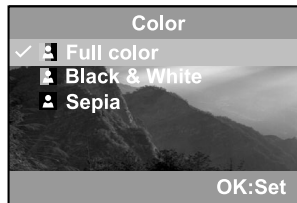

E



### NOTE

- The color setting is not possible in [A] Auto mode.

## Saturation

To capture an image, the camera offers you three different degrees of color (High/Medium/Low) for you to match as your wish. Your images will give a different impression by choosing these different degrees of color. This is called Saturation.

To set the color, first press the **OK** button. Then choose the appropriate color saturation (High/Medium/Low) you prefer by pressing the **▲ / ▼** button and then press the **OK** button again to confirm.

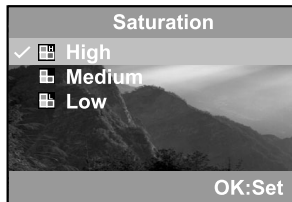

### NOTE

- The saturation setting is not possible in **[A]** Auto mode.

## Sharpness

The camera will automatically emphasize the borders between light and dark areas of the image. This will make the image's edges seem sharper.

To set the Sharpness' detail, first press the **OK** button. Then choose the appropriate sharpness degree (High/Medium/Low) you prefer by pressing the **▲ / ▼** button and then press the **OK** button again to confirm.

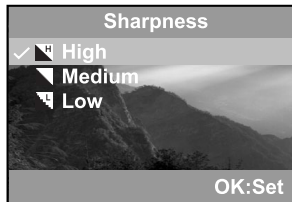



### NOTE

- The sharpness setting is not possible in **[A]** Auto mode.

## The Playback Menu

Use the Playback menu to transfer your recorded images/video clips to a memory card, to create an on-camera slide show displaying or figure DPOF settings. You can also use the Playback menu to delete one or all images, to format the memory card or the internal memory and also record your voices as your preference.



- E** To access the Playback menu, press the  button first and then press the  button. Scroll through the menu options by using the  /  button.

### Delete

Refer to "Deleting Images/Video Clips" in Playback Mode.

### Copy to card

This feature allows you to copy your images from the camera's memory card or an internal memory. However, you can only do this when the memory card is installed and the internal memory contains images.

To perform this function, first press the **OK** button. Then select [No] or [Yes] by using the  /  button and press **OK** button to confirm. Showing the copying process a bar displays and the screen indicates "Copy to card".

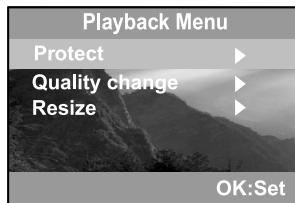
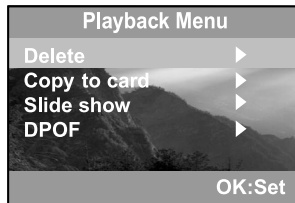

## Slide show

Refer to "Slide Show Display" in Playback Mode.

## DPOF

Refer to "Setting DPOF" in Playback Mode.

## Protect

Refer to "Protecting Images/Video Clips" in Playback Mode.

## Quality change

Change the quality (resolution) of the captured image to Normal or Economy.

To perform this function press **OK** button to display the sub-menu. Select the image quality as you preference by pressing **▲/▼** button, then press the **OK** button.

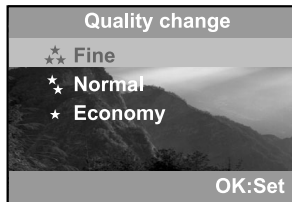

## Resize

Change the size of the captured image to 1600x1200 pixels, 1280x960 pixels or 640x480 pixels.

To perform this function press **OK** button to display the sub-menu. Select the image quality as you preference by pressing **▲/▼** button, then press the **OK** button.



## The Setup Menu

You can select your preference for the camera settings in Setup mode. Rotate the mode dial to Setup mode and navigate to the option you wish to configure by using the ▲ /▼ button.

### E Date & time

Refer to "Setting the Date and the Time" in GETTING STARTED.

### TV

You can view your images on a TV. Remember to select the correct video output type according to where you are located.

To set this option, first press the **OK** button. Then use the ▲ /▼ button to select your TV receiving system [NTSC] or [PAL] and then press **OK** button to confirm.

[NTSC]: Select this format when located in the U.S.A., Canada, Japan, Korea, Taiwan, Central America, or Mexico.

[PAL]: Select this format when located in Australia, Belgium, China, Denmark, Finland, Germany, Great Britain, Holland, Italy, Kuwait, Malaysia, New Zealand, Singapore, Spain, Sweden, Switzerland, Thailand or Norway.

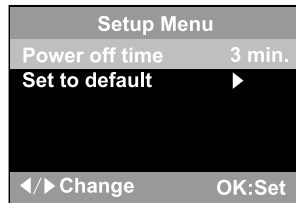
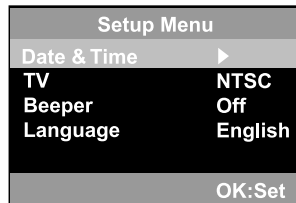



## Beeper

The camera makes a sound (beep) each time you press the camera button if this function is enabled.

Press the **OK** button. Then select beeper [Louder], [Soft] or [Off] by using the ▲ /▼ button and then **OK** button to confirm.

- The camera defaults to [Off].



E

## Language

This option allows you to select the language for the menus and the texts displayed on the LCD monitor.

To set the language, refer to the section "Choosing the Language".

- The provided languages are [English], [Français], [Deutsch], [Español], [Italiano], [Português], and [Nederlands].
- The camera defaults to English.

## Power off time

If the camera remains unused for a certain period of time while the camera is powered on, the camera will switch to an "idle" mode, and eventually turn itself off to conserve the power.

Inactivity period (Batteries)	Inactivity period (AC Power Adapter)	Camera Status
60 seconds	60 seconds	Stay Idle
3 minutes	30 minutes	Shut Off

If the camera is idle, re-activate the camera by pressing any button or rotate the mode dial. If the camera has powered-off then you must turn the camera on again by sliding the **POWER** switch. To change the power saving interval when the camera is charging with batteries, first press the **OK** button. Then select the power-off interval you prefer by using the **▲ / ▼** button and then **OK** button to confirm.

[3 min], [5 min], [10 min], [30 min], [Off]

■ The camera defaults to [3 min].

## Set to default

If you wish to restore all camera settings to their original status, select this option and then press the **OK** button. Then select [No] or [Yes] by using the **▲ / ▼** button and then **OK** button to confirm.

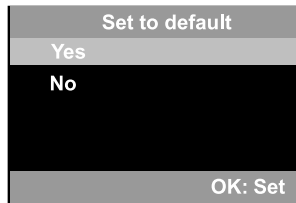

# CONNECTING THE CAMERA TO OTHER DEVICES

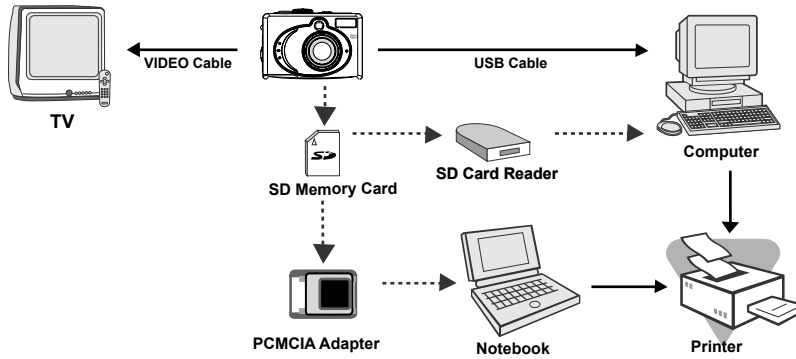

E

# CAMERA SPECIFICATIONS

<b>Item</b>	<b>Description</b>
Image sensor	1/1.8" CCD
Effective pixels	5.0 Million
Image size	Still Image: 2560 x 1920 1600 x 1200 1280 x 960 640 x 480 Movie image: 320 x 240
Image quality	Fine Normal Economy
Recording media	11MB internal memory; SD memory card (optional)
Lens	Focal length: 7.8mm~23.4mm Focusing range: Wide: 0.2m~infinity Tele: 0.4m~infinity F-number: 2.77~4.9

E

LCD monitor	1.6" color TFT LCD
Self-timer	5-second delay 10-second delay
Zoom	Optical: 3X Digital: Capture mode: 4X/ Playback mode: 6X
Exposure compensation	Auto; Manual: -2.0 ~ +2.0 EV (0.5 EV)
White balance	Auto; Manual: Daylight, Cloudy, Sunset, Tungsten, Fluorescent
Compressed format	JPEG, MPEG 1 Level I for video clip
Standards	JPEG, EXIF 2.1, DPOF, DCF, MPEG 1 Level I
Interface	DC IN jack, USB connector, VIDEO OUT jack (NTSC or PAL)
Operating environment	Operation: 0°C ~40°C, 15% ~90% humidity Storage: -20°C ~60°C, 10% ~95% humidity
Power	2 x AA Alkaline batteries, 2 x AA Ni-MH batteries, CR-V3, AC power adapter (3.0V/2.5A)
Tripod socket	Yes
Dimensions	95mm x 64mm x 36mm (WxHxD)
Weight	Approx. 180g (without batteries and the SD memory card)

- Design and specifications are subject to change without notice.