

# Preface

Thank you for choosing this mp3 player. For your proper and skillful use, this manual will introduce all the functions of the player in detail. Please read this manual carefully. It will be helpful for you to enjoy high quality mp3 music. We think the content of this manual is compiled seriously and correctly. Please inform us in time if any mistake or careless omission occurs.

## Table of contents

- 1) **features**
- 2) **introduction of operation interface**
- 3) **battery loading and unloading**
- 4) **software installation**
- 5) **file uploading and downloading**
- 6) **operating functions**
- 7) **operation precautions**
- 8) **specification**
- 9) **accessories**

## 1) **features**

- Support MP3, WMA, WAV format music
- Recording function (about 500mins for 128MB flash)
- Line-in function (WAV format)
- FM stereo radio and inner recording
- Portable flash memory
- Repeat function
- Six EQ models: Jazz, Classic, Rock, Bass, Popular and Normal
- Six play model: sequence, random, single repeat, totally repeat, random repeat totally, 10 second preview
- OLED color picture display
- TXT reading
- Support edit play function
- USB 2.0 port
- Support Windows95/98/2000/ME/XP, no drive for Windows2000/ME/XP
- Support simple and capital Chinese, English, Korean, and European Languages

- Lyric synchro display
- Inner set flash memory: 128MB, 256MB, 512MB and 1G
- Playing time: over 8 hours
- 32 class volume adjustment
- Key button locking function

## 2) introduction of operation interface

### Panel description

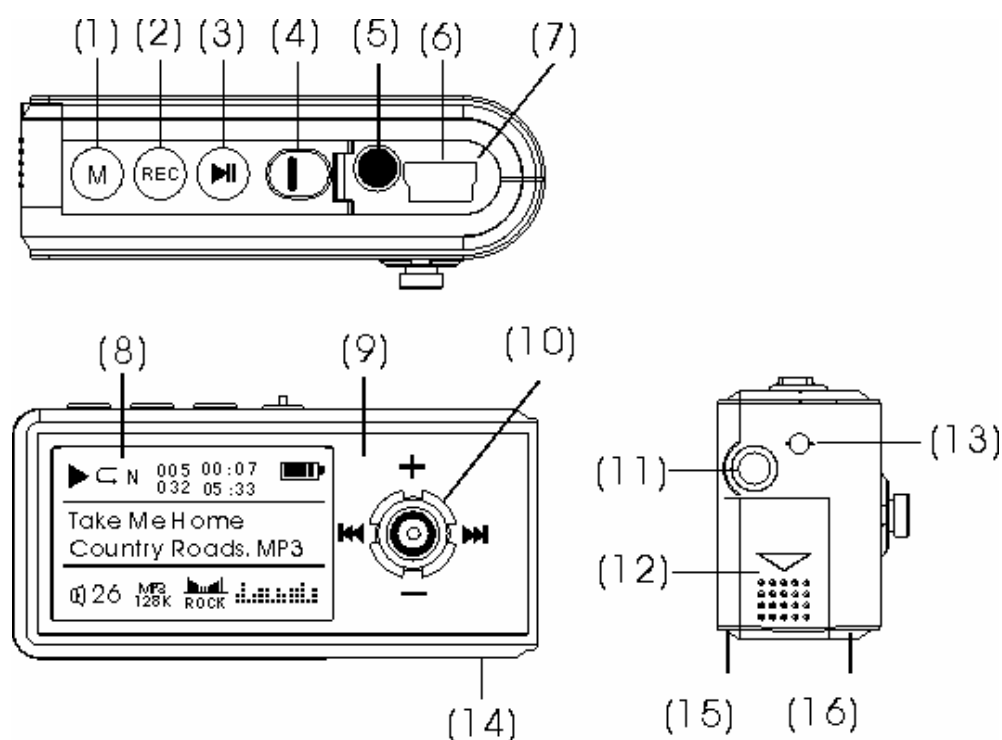

1. Functional button
2. Recording button
3. Power on / off / play /pause
4. Hold lock / unlock
5. Line-in jack
6. USB socket
7. USB cap
8. LCD display
9. Aluminum deck
10. Multi-functional button  
There are four functions on the button. They are volume up and down, search previous and next
11. Earphone jack
12. Battery door
13. Rope hook
14. MIC inner microphone
15. cover board (bottom)
16. cover board (face)

## A. LCD display

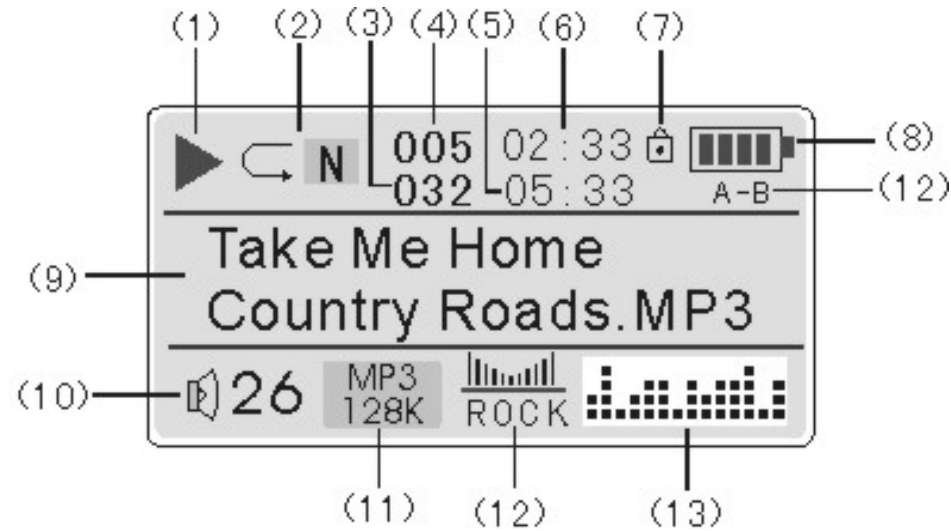

1. play / stop / pause indication
2. play model indication
3. total song amount
4. sequence number of current song
5. total playing time of current song
6. elapsed time of current song
7. button lock indication
8. battery power indication
9. song and singer display

10. current volume indication
11. sort of the song and bytes
12. sound effect
13. dynamic sound effect indication

## 3) Battery loading and unloading

1. To open the battery cabin, push the battery door in the direction the arrow indicates
2. Load the AAA 1.5V battery into the battery cabin in the indicated pole direction. Push to close the battery door.
3. Turn on the power. Press ►|| to check the electric power remained
4. **Caution: If not using for a long time, please take out the battery. When there is no power display after battery loaded and power on, please check to see if it is properly loaded in right direction. Otherwise please contact your local service for help.**

## 4) Software installation

- A. Your PC must support: WIN98 ver2.0, WIN ME, WIN2000, WINXP.
- B. Your PC must be and have: IBM compatible, Pentium 166MHz processor or above, USB port, 32MB memory or above, 20 MB idle hard disk space or above, optical drive of 4 times speed or above, sound card (recommended), able to surf internet (recommended)
- C. For Windows98 operating system, you need to install the drive software to insure linkage and data transfer between your PC and the mp3 player. For Windows2000 / ME / XP, just insert the player into USB interface directly. The PC can auto-recognize. When the computer keeps showing “New Hardware Found”, please click “the next step” or “confirm”. To recover and upgrade mp3 firmware, you still need to install the driving software.

- D. If your computer has had the driving software, the system may automatically unload when trying to install again. Please do not connect the player. Otherwise it may lead to possible malfunction for future installation and operation.
- E. This mp3 software is an inter-dynamic interface between the player and the computer. Files and data as MP3 / WMA / voice and other data can all be downloaded and uploaded between the player and your computer.

### F. Installation Procedure

1. Turn on the computer
2. Load the driving software CD
3. Double click to run “SETUP” and follow the hint to click “NEXT” or “YES”. The software will be loaded on your PC.
4. When installation completed, “Sigmatel MSCN Audio Player” will appear in the “START-PROGRAM” menu on

the desktop which means a correct installation.

**Note: For Windows98 system, you have to restart your computer.**

5) File uploading and downloading

**A.** After software installed on PC, to upload and download MP3 / WMA or other files, you need to connect the player with a USB line.

**B.** When connected, a link icon appears on the LCD of the mp3 player. And your PC will automatically find the portable memory disc.

**B.** Your computer will regard the mp3 player as a portable memory disc. By duplicating, it can upload and download MP3 / WMA or other files as you need. During data transmission, the icon on the LCD will flicker until transmission done.

**C. Cautions**

1. When loading files, never disconnect or remove the USB line to avoid damage of the mp3 player. Never start

loading until “READY” appears on the LCD.

2. If the player can not work properly accidentally, please take out the battery, reload it after 3 seconds and reconnect to the computer.

3. The player supports WAV files in IMA ADPCM format. If you intend to save WAV files in other formats, please create a new folder in the portable memory disc and save WAV files to this folder. Please note: do not save WAV files of other format to the root catalog and the VOICE folder of the portable memory disc. It may cause the player not effecting when playing the WAV files.

4. Format the memory of the mp3 player  
Before formatting, copy crucial files to your computer. Turn on the player and be sure it is properly connected to the computer.

- Format the memory disc of the player as do the hard disc
- Warn: Formatting could dele all files in the memory.

Don't disconnect when formatting. Otherwise the player cannot startup because the system files could be lost.

### Cautions:

Don't disconnect power supply and don't unplug the player while the icon shown on the LCD flickers during uploading / downloading under the system of Windows2000 / Windows ME. Be sure follow safe instruction to unplug. When insert the player to the USB port, you may find a



“CH” icon on desktop as shown below. Double click this icon, a new window of “unplug or exit” appears. You may choose what you are going to remove. Then choose “stop”. The system will again ask you confirm to remove or not. Select “confirm”. The system will remind you “you may be comfy to remove the hardware” and you may remove the player from your computer with ease. Don't disconnect power supply and don't unplug the player

while the icon shown on the LCD flickers during uploading / downloading under the system of Windows98 / 95. Otherwise data could be lost of files be damaged. Be sure to remove the player from your computer at least 5 seconds after the icon stops flickering.

## 6) Operating functions



### A. Turn on

Insert earphone into the earphone jack. Push Lock button unlocked. Press ▶|| to turn on the player and stand by. Press ▶|| again to play music. See left below.



**B. Power off :** When it is standing by, press ►|| and hold on until the picture appears on the LCD. See right below.

**C. Play MP3 music files**

- 1 After turn-on, press ►|| to play, see up left figure. Press the ►|| button again to pause. The play sign  become pause sign . Press the ►|| button again to continue to play. Press ►|| and hold on for 2 seconds to stop playing.
- 2 Press ◀◀ or ▶▶ to select previous or next song. , Press ◀◀ or ▶▶ and hold on to fast forward or fast backward
- 3 When playing or standing by, press “+” or “-” to increase or decrease volume.
- 4 **Notice: When playing, the battery power may jump, it is not a malfunction. It is because of the different power consumption.**

**D. Recording/playing function**

- 1 When playing, press the “M” button to enter function menu. Press ◀◀ or ▶▶ to select “VOICE” menu. See left figure below. Press “M” again to enter voice interface. See right figure below.

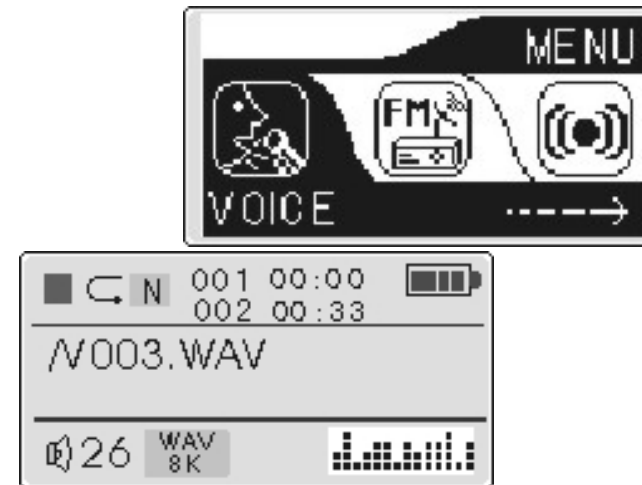

- 2 Press ►|| to play the files recorded. Press ►|| again to pause. Press ◀◀ or ▶▶ to select the previous or next catalog. Press “+” or “-” to increase or decrease volume. If there is no file recorded, “ No file recorded ” will display on the LCD.
- 3 Press “●” to start recording. Recording interface is as left below. 00:00:33 is time spent to record.

09:12:56 is the remaining time to record.

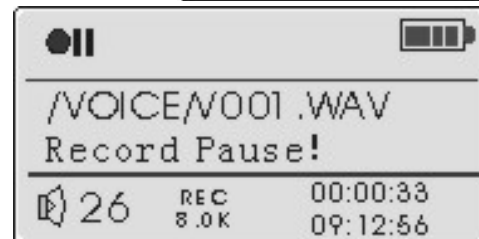
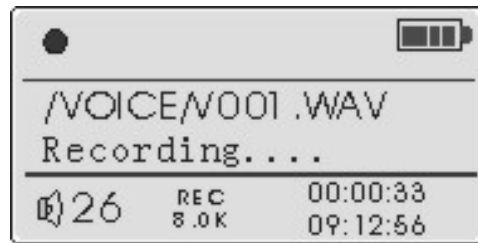

- 4 Press ►|| to pause recording. See up right figure. Press ►|| again to continue to record. When finishing, press “●” to stop recording and back to recording interface. Press ◀◀ or ▶▶ to select the last recorded files. Press ►|| to play the file. When playing press “●” button to set start point of repeat, press “●” again to set end point of repeat and play the set part circularly. Press “●” again to cancel repeating and continue to play. Press “M” button transitorily to exit recording function and back to the up menu.

- 5 When there is no more room for the memory disc to record, It will show: “memory occupied” . Press “●” to stop recording. It will auto-stop and back to play model
- 6 When standing by, press “●” and hold on for 2 seconds to enter voice operation directly without pressing “M” button.

### **E. Line-in function**

- 1 This function enables the player to transfer voices brought by exterior audio devices into WAV format and be saved. Please refer to recording setting in H..5.
- 2 There is an audio cable in the accessories. Plug one end into “Line-in” jack or audio out or earphone jack. Open the USB cap and plug the smaller end in the “LINE” jack. Press the “PLAY” button of the exterior audio device to play in medium volume.



- 3 Press “M” to enter function menu. Press ◀◀ or ▶▶ to select “LINE-IN” menu. See left figure below. Press the “M” button again to start recording. See right figure below. 00:00:33 is the current recording time while 09:12:56 is the time remained. Recorded files are saved in the “LINE-IN” folder of the mp3 player which will be automatically named as Lxxx.MP3.

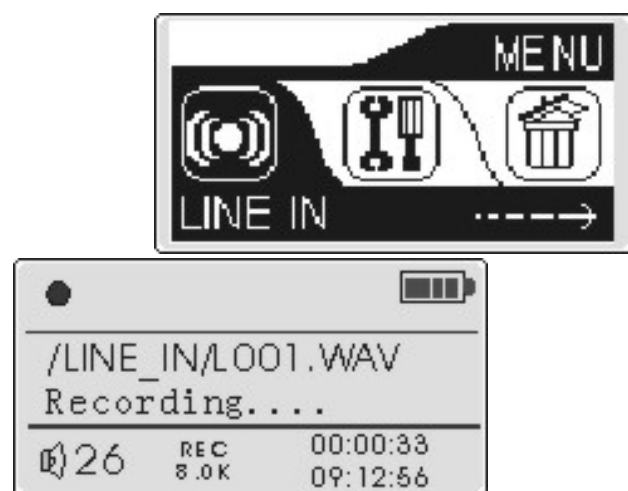

- 4 Press ▶▶ to pause recording. Press ▶▶ again to continue. Press “●” button to stop and back to voice playing interface. Press ◀◀ or ▶▶ to select the file recorded. Press ▶▶ to play.

## F. Radio operation

- 1 Enter radio menu: Press ▶▶ to turn on. Press “ M ” to enter function menu. Press ◀◀ or ▶▶ to select “FM RADIO”. See left figure below. Press “M” again to enter the interface to choose stations. See right figure below.



- 2 Listen to broadcasting: Press ◀◀ or ▶▶ to choose local stations saved. (need to search and save in advance) Press “+” or “-” to increase or decrease the volume. This player will automatically search all local broadcast programs at your first turning on and

entering radio model. As shown in the left figure below, the auto-searching takes about 45 seconds. It will broadcast programs of the first station automatically. If the stations are too less or not clear, please follow step 3 and step 4 to search manually and save.

- 3 Manual searching: As show in the figure above, press “M” to enter searching. “Radio” turns into “Scan” as shown in the left figure below. Press ◀◀ or ▶▶ to manually adjust the frequency in variety of 0.1MHz. Press ◀◀ or ▶▶ and hold on to auto-searching. Searching will stop and play the first station when searched. If the stations are too less or not clear, we suggest you press ◀◀ or ▶▶ shortly.

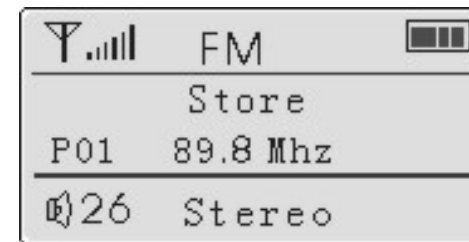
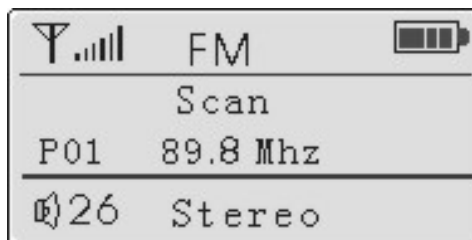

- 4 Save stations: After manual searching , press “M” to enter “Store” as shown in the up right figure. Press ◀◀ or ▶▶ to select a station to save. Then press ▶▶ to save as shown in the left figure below. 30 stations could be saved. The player will automatically return to radio model.

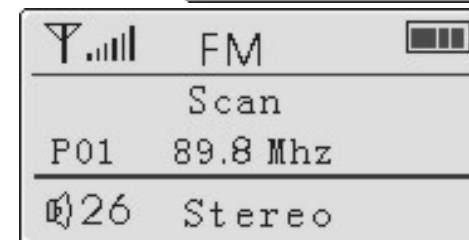
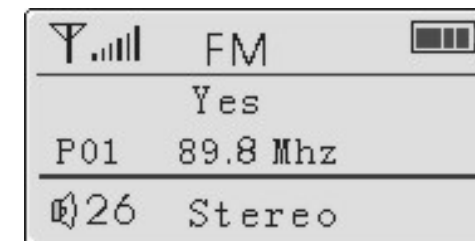

- 5 Auto searching: When enter to scan, press ▶▶, the player will search all local stations and save automatically as shown in the up right figure. It will

automatically turn into radio model and play the first broadcast station saved after auto searching.

- 6 Dele station: After auto searching, press ◀◀ or ▶▶ to select to listen radio programs one by one. If the program is not clear, you may dele. Choose the station you are intended to dele, press “M” to enter dele model as shown in the left figure below. Press ▶▶ to dele and it returns “radio” model automatically as shown in the right figure below.

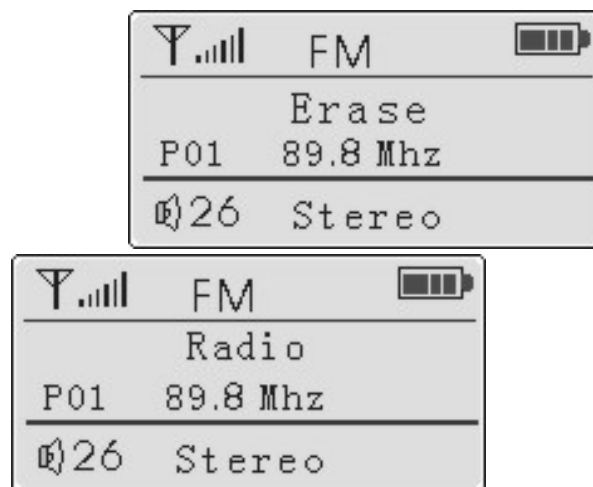

- 7 Radio recording: When listening to a radio program and intend to record, press “●” button to record the program you are listening. See the left figure below.

Press ▶▶ to pause. Press the ▶▶ again to continue. Press “●” again to back to radio model. To play the radio programs recorded is operated as to play the files, back to voice menu, press ◀◀ or ▶▶ to select saved file to play. The recorded radio program files are auto named as “FXXX.WAV” and saved in the FM folder of the player. The FM folder is auto-created when recording.

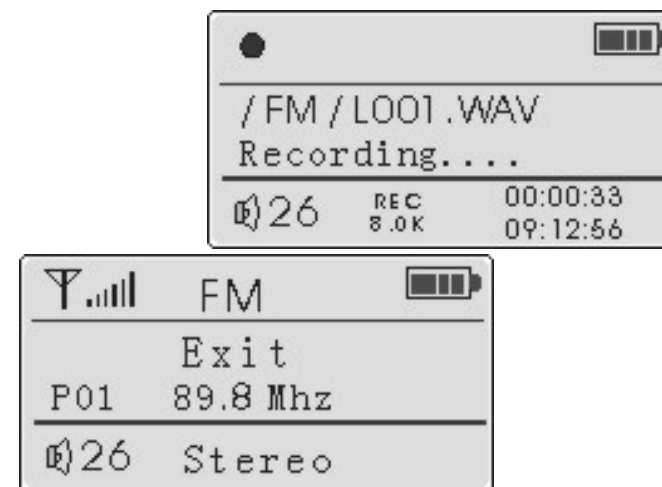

- 8 Exit: Press “M” and hold on until return menu appears as shown in the up right figure. Press ▶▶ to return to MP3 model.

**Note:** Pressing ▶▶ can only temporarily save the

stations. Saving will be lost when take out the battery. To save permanently, pressing ►|| button long and ordinary power off are required. One station may be selected directly to listen without searching on next turn on.

## G. Repeat function

- 1 When playing mp3 or recorded files and at the start point of a paragraph which you need to repeat, press “M” shortly. Set the start point “A” as shown in the left figure below.

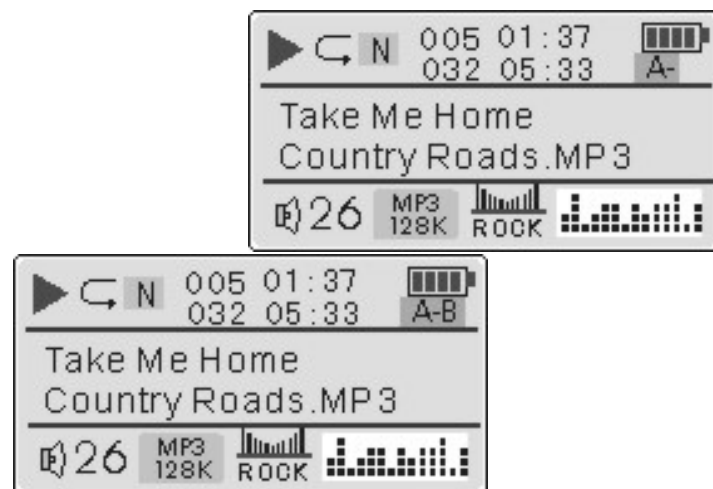

- 2 Continue to play. At the end point of the paragraph,

press “M” again. Set the end point “B” as shown in the up right figure. The player will play circularly between A and B.

- 3 When playing circularly between A and B, press “●” button to cancel repeating. The player will play the current music. You may cancel repeating by pressing ◀◀ or ▶▶ and select a song as you like.

## H. Menu setting operation

### 1 EQ setting

You may select different EQ model upon different type of music you enjoy. There are 6 EQ models, JAZZ, CLASSIC, ROCK, BASS, POP and NORMAL.

- a) Press ►|| to turn on the player . Press “M” to enter function menu. Press ◀◀ or ▶▶ to select setting as shown in the left figure below.



- b) Press “M” to enter setting interface. Press “+” or “-” to select EQ as shown in the up middle figure. Press “M” again to enter the EQ interface as shown in the up right figure.
- c) Press “+” or “-” to adjust different EQ. Press “M” to confirm and exit the current setting. Press “+” or “-” again to select exit menu to exit.
- d) When playing mp3 music, pressing “●” may also change the EQ model. Release the button and press it again, EQ model may be changed once more.
- e) Note: There is no EQ selection for every recording file.

## 2 Play model setting

When playing, you may prefer to enjoy one song or whole songs circularly. This function may implement.

- a) When turn on or playing, press “M” to enter function menu. Press ◀◀ or ▶▶ to select setting. Press “M” again to enter setting interface. Press “+” or “-” to select play model interface as shown in the left figure below. Press “M” again to select play sequence interface as shown in the right figure below.

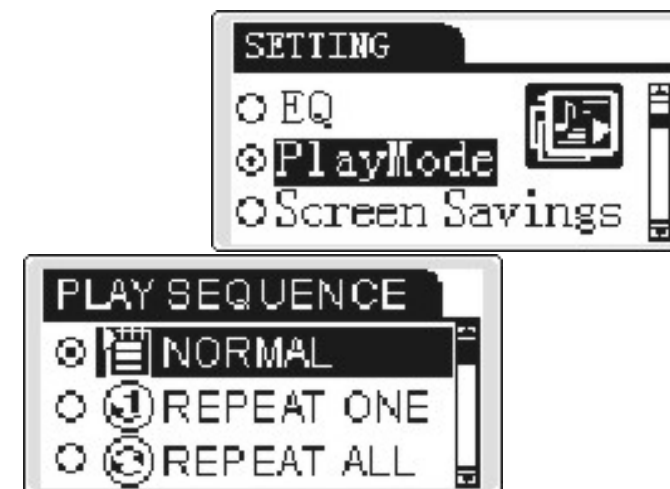

- b) Press “+” or “\_” to set circular model.

Circular models are in sequence: sequence, random, single repeat, totally repeat, random repeat totally, 10 second preview.

Sequence: all songs play once in order and stop

Random: play random as per the player's inner setting

Single repeat: circular play current song

Totally repeat: play as per the player's inner setting and repeat all

Random repeat totally: play all the songs random and repeatedly

10 second preview: play the first 10 seconds of each song

### 3 LCD protection

- a) When turn on press "M" to enter function menu. Press ◀◀ or ▶▶ to select setting. Press "M" again to enter setting interface. Press "+" or "-" again to select LCD protection setting as shown in the left figure below.



- b) Press "M" again to enter LCD protection time setting interface as shown in the up right figure.
- c) Press ◀◀ or ▶▶ to increase or decrease the time. When finished press "M" to return to the upper menu.

### 4 Turn off setting

This setting is to turn off the player in a period when there is no operation after turn on.

- a) When turn on press "M" to enter function menu. Press ◀◀ or ▶▶ to select setting. Press "M" to enter setting interface. Press "+" or "-" to select turn off setting interface as shown in the left figure

below. Shortly press “M” again to set as shown in the right figure below.

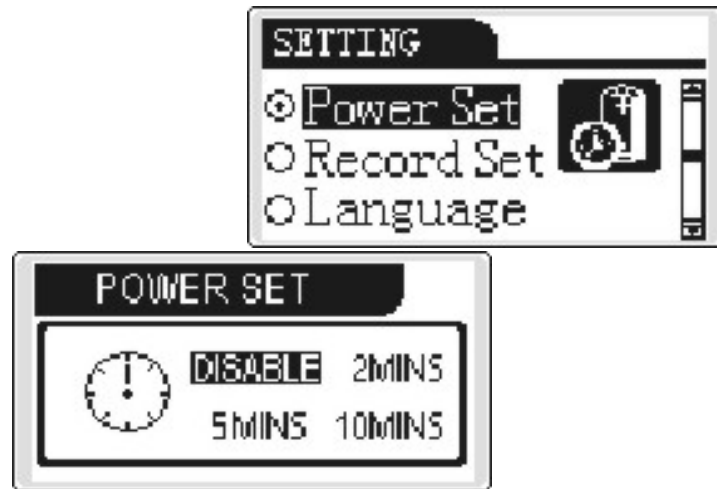

- b) Press ◀◀ or ▶▶ to select the auto off time when the player is on but there is no operation. Time: forbidding, 2 seconds, 5 seconds, 10 seconds

Note: If selecting 2 seconds and there is no operation, the player will turn off automatically in two seconds.

## 5 Recording setting

- a) When turn on press “M” to enter function menu. Press ◀◀ or ▶▶ to select setting. Press “M” again to enter setting option. Press “+” or “\_” to select recording setting as shown in the left figure below.

Press “M” again to select a setting term as shown in the right figure below. When a term selected, press “M” to change the term.

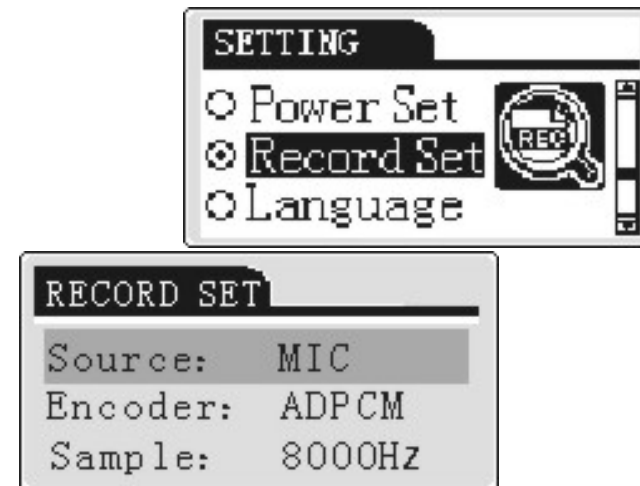

- b) There are three recording terms: source, encoding, sampling

- Source: To set recording source, the player could choose either microphone or external input. When recording by inner microphone, set microphone. When recording from external (LINE-IN), set external input as shown in the left figure below.

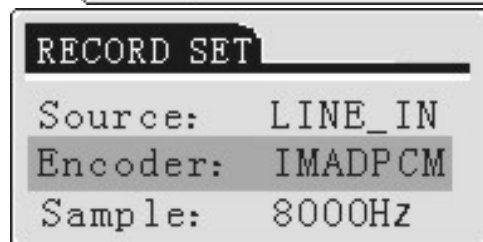
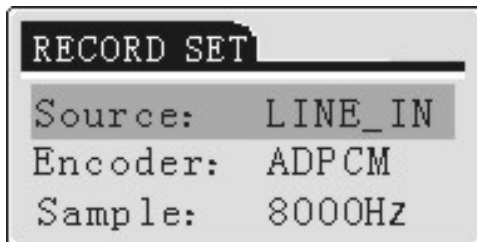

- Encoding: This term is to set the sampling encoding. Press “+” or “\_” to select encoding as shown in the up right figure. Press “M” again to change once. When recording from external (LINE-IN), set IMADPCM as shown in the up right figure.
- Sampling: To set for sampling frequency. Press “+” or “\_” to select sampling as shown in the left figure below. Press “M” to change as shown in the right figure below. Higher sampling frequency brings better music quality but takes more memory room.

Generally inner recording sampling frequency is 8KHz while LINE-IN recording sampling frequency is automatically set at 32 KHz that might be rectified by users.

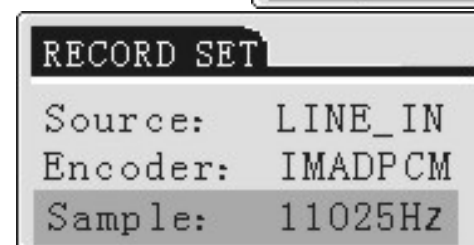
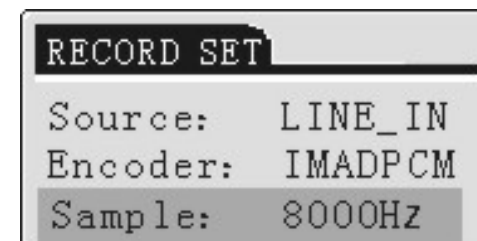

- c) If not entering the recording setting to rectify the above terms, when recording from inner MIC, it will be auto-set as “Microphone / PCM / Mono-/8k”. When recording from external, it will be auto-set as “LINE-IN/ IMADPCM/ Stereo/ 32k.
- d) After setting press “●” to return the upper menu. We suggest users not to rectify except special occasions occur.



## 6 Language selection

When turn on, press “M” to enter function menu. Press ◀◀ or ▶▶ to select setting. Press “M” again to enter setting option. Press “+” or “-” to select language setting interface as shown in the left figure below. Press “M” again to enter language setting options. Press “+” or “-” to select a language as shown in the right figure below. When a language selected press “M” to return to the upper menu.



If strange symbols occur to the loaded song name, set the

language to obtain correct display.

### Caution:

- When finishing one setting, press ▶|| to turn off, setting will be saved. If taking out the battery to turn off, all settings will not be saved.
- To save the battery power, the turn off setting is important. Generally be 2 seconds.

### I. Dele file

To dele files in the mp3 player, you may either operate the key buttons of the player or apply a PC .When songs or voice files need to be dele, follow the operation below:

- Turn on the player, press “M” to enter function menu. Press ◀◀ or ▶▶ to select “DELE” as left figure below. Press “M” again to enter “dele file” menu. Press ◀◀ or ▶▶ again to select “dele music files” or “dele

voice files” as shown in the right figure below.

Select “dele music files”.



- Press “M” to enter dele music files interface. Press ◀◀ or ▶▶ to select the file as shown in the left figure below. Press “+” or “\_” to confirm the file, select “yes”. Then press “M” to dele the file. “successful” will appear on the display as shown in the right figure below. If “dele failure” appears on the display, please link the mp3 player to your PC and check the attribute of the song, change “read only” into “save”.

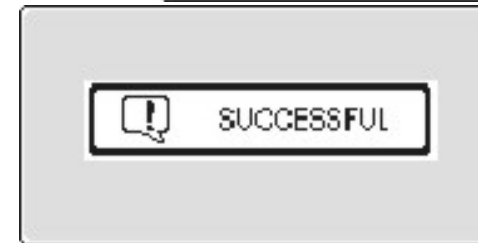

- Press “●” to return to the upper menu.

## J compiling play function

When there are various music folders in the player, edit play function could make the player to play a sole song or file in a single folder independently.

- a Turn on the player, press “M” to enter function menu. Press ◀◀ or ▶▶ to select “navigate” as shown in the left figure below. Press “M” again to enter the sub-menu of “navigate”. Press “+” or “-” to select “P&S play” as shown in the right figure below.

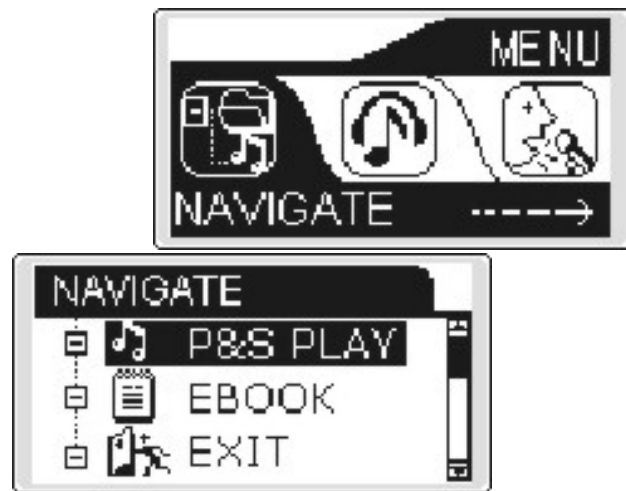

- b Press “M” again to enter the root directory. Press “+” or “\_” to select a folder or a song. Press ►|| to play the content of the folder or the selected song..
- c Press the “M” again to return to the folder selection. Press “●” to return to the upper menu, select “exit”. Press “M” to return and compiling play function be canceled.

## K TXT reading

Files in txt format may be saved in the player. When txt files are downloaded, you may read on the player. Press “M” to enter menu. Press ◀◀ or

▶▶ to select “navigate” as shown in the left figure below. Press “M” again to enter sub-menu of “navigate”. Press “+” or “\_” to select “EBOOK” as shown in the right figure below. Press “M” again to enter file options. Select a file and again press “M” to start reading. Press “+” or “-” to up and down. Press “●” to return.

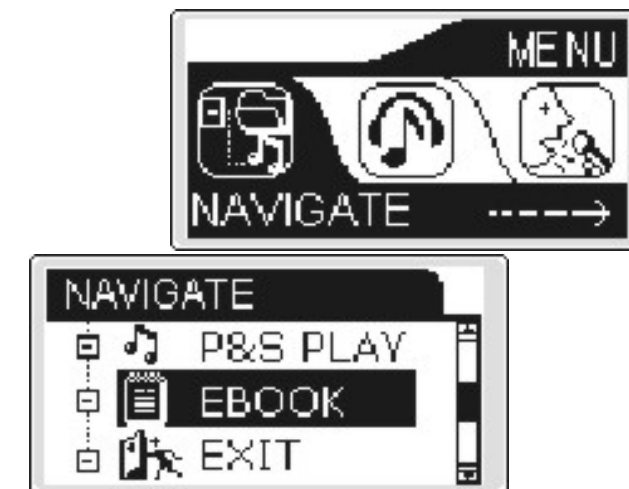

## L Memory and Version inquiry

Turn on the player, press “M” to enter function menu. Press ◀◀ or ▶▶ to select “INFO” menu, as shown in the figure below , Press “MENU” to

enter. You are easy to find the memory room remained and the version of the player. Press “M” to the upper menu.

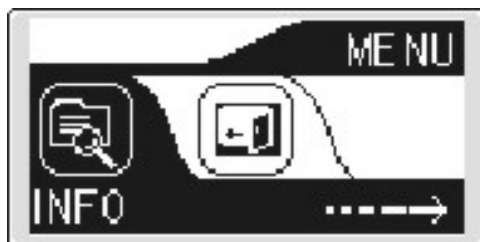

## M Lyrics synchro display

- There must be Lyric file which has the same name of the song in the mp3 player. The two files should have the same name under one catalog except the extensive name. The extensive name of the Lyric files should be LRC.
- Make Lyrics file  
Generally there are two methods to make lyric files. One is to use notebook tool in operation system. The other is to use

professional lyric software. Both of them are using time sequence to edit. They have the form as “(mm:ss)” or “(mm:ss:ff)”.

## 7) Operation precautions

### 1 Precautions

a prevent from overheated, moist environment

To assure the device, do not use it in surroundings as overheated, extreme cool, wet. Shower room with high temperature is strictly prohibited. Do not expose to stove, oven, or long time sunshine as in a parked car.

### b Prevent collide

Avoid dropping from high places, or collide with hard objects. It may cause damage.

c Please do not disassemble the device. For query regarding the device, please contact us, or your local service center or distributor.

d Remove the battery when not use for long. Battery linkage may damage.

## 2 Trouble shooting

a Press ►||, no display

- There is no battery loaded, load one.
- The battery be exhausted or not be loaded in the right direction.
- LCD contrast ratio not properly set, set contrast ratio again
- Due to accident, the device does not work. Removal the battery, install back in about 5 seconds

b Settings can not be saved  
press ►|| and hold on for a while and turn off the device to keep long time saving.

c Shut-down again after turn on the device for several seconds.

- Check if the device has been locked up. Push unlock the player by moving HOLD
- Check if battery be exhausted

d Shut -down again after turn on the device for several minutes

It is a setting to save power. When no instruction has been sent, it turns off automatically. You may cancel this setting.

- e There is no sound when playing
- Volume setting is too low. Adjusting
  - No music file in the player
- f After connection, portable hard disc not found.
- Check if you have properly loaded the drive software
  - Loading software be damaged
  - Your PC doesn't support USB port. You need to upgrade  
Your computer driving software
  - Or your computer has loaded some higher driving software. Delete all INF and PNF files which contain "Sigmatel" info, in "OEMO-6.INF" and "OEM-6.PNF" under Windows/INF"

- g Can not play MP3 file
- This device supports only standard compressed format, make sure you have the right compressed method. Do not compress using 1<sup>st</sup> or 2<sup>nd</sup> layer.

- h Why there is no time showing when playing some songs?

For MP3 files, adopting VBR format (namely compressed mp3 files with variable speeds). It will display only "VBR". To have time display, you may re-compress the files by adopting fixed speed.

## 8. Specifications

flash memory	128MB/256MB/512MB/1G
battery	1 AAA alkaline 1.5V
display	OLED color
dimension	57x27x18mm
file transfer speed	4Mbps max
SNR	90 dB
Maximum Output	5mW(L) + 5mW ®
Frequency Response	20KHz-20KHz
Recording Sampling	8KHz-32KHz
FM Frequency	88MHz-108MHz
Compress Speed	MP3, 8Kbps-320Kbps WMA, 5Kbps-192Kbp

## 9) Accessories:

1	MP3 player	1 set
2	USB cable	1 set
3	Line-in Audio line	1 set
4	Earphone	1 set
5	CD	1 set
6	Manual	1 set
7	AAA battery	1 set
8	Warrant card	1 set
9	QC pass card	1 piece