

M304X
**Series Line Printer
OEM Manual**



REVISION RECORD		
Edition	Date published	Revised contents
01	Aug., 1983	
02	Nov., 1984	Rewritten
03	Jun., 1985	Retyped and description of, RS-232-C interface and options added.
04	Aug., 1985	Pages 4-40, 9-6 added. Pages 4-3, 4-28, 4-31 - 4-39, 4-41, 4-42, 4-45, 4-49, 6-7, 6-8, 6-15, 9-5 modified.
05	Jun., 1986	Chapters 4 to 9, pages 2-2, 2-3, 2-5, to 2-8, 2-10 to 2-20 revised.
06	Nov., 1986	Pages 2-3, 4-4 and Chapter 8 revised. Chapter 9 deleted.
Specification No.: B02P-1500-0001A		

FB113626

The contents of this manual may be revised without prior notice.

All Rights Reserved, Copyright © 1992 FUJITSU LIMITED.
No part of this manual may be reproduced in any form without permission.

Address your comments and inquiries on this manual to:

FUJITSU COMPUTER PRODUCTS
OF AMERICA, INC.
2904 Orchard Parkway
San Jose, CA 95134, U.S.A.
TEL: (408) 432-6333
FAX: (408) 894-1709

FUJITSU FRANCE S.A.
17, rue Olof palme
94006 Créteil cedex, FRANCE
TEL: (33-43) 99 40 00
FAX: 99 07 00
TLX: 262 661

FUJITSU AUSTRALIA LIMITED
475 Victoria Avenue, Chatswood
N.S.W., 2067, AUSTRALIA
TEL: (61-2) 410-4555
FAX: 411-8603
TLX: 25233

FUJITSU HONG KONG LIMITED
Room 1831, Sun Hung Kai Centre
30 Harbour Road, HONG KONG
TEL: (852-5) 8915780
FAX: 742917
TLX: 62667

FUJITSU CANADA, INC.
2800 Matheson Blvd. East, Mississauga
Ontario, L4W 4X5, CANADA
TEL: (1-416) 602-5454
FAX: 416-602-5457
TLX: 968132

FUJITSU ITALIA S.p.A.
Via Melchiorre Gioia, 8-20124 Milano, ITALY
TEL: (39-2) 6572741
FAX: 6572257
TLX: 350142

FUJITSU DEUTSCHLAND GmbH
Frankfurter Ring 211
8000 München 40, F.R. GERMANY
TEL: (49-89) 32378-0
FAX: 32378-100
TLX: 897106

FUJITSU NORDIC AB
Torggatan 8, S-171 54 Solna, SWEDEN
TEL: (46-8) 764 76 90
FAX: 28 03 45
TLX: 13411

FUJITSU ESPAÑA, S.A.
Edificio Torre Europa
Paseo de la Castellana 95, Madrid 28046, SPAIN
TEL: (34-1) 581-8000
FAX: 581-8300
TLX: 23887

FUJITSU LIMITED
International Operations
Marunouchi 1-6-1, Chiyoda-ku, Tokyo 100, JAPAN
TEL: (81-3) 3216-3211
FAX: 3213-7174
TLX: J22833
Cable: "FUJITSU LIMITED TOKYO"

FUJITSU EUROPE LIMITED
2 Longwalk Road, Stockley Park, Uxbridge
Middlesex, UB11 1AB, ENGLAND
TEL: (44-81) 573-4444
FAX: 573-2643
TLX: 263871

B02P-1500-0001A . . . 06

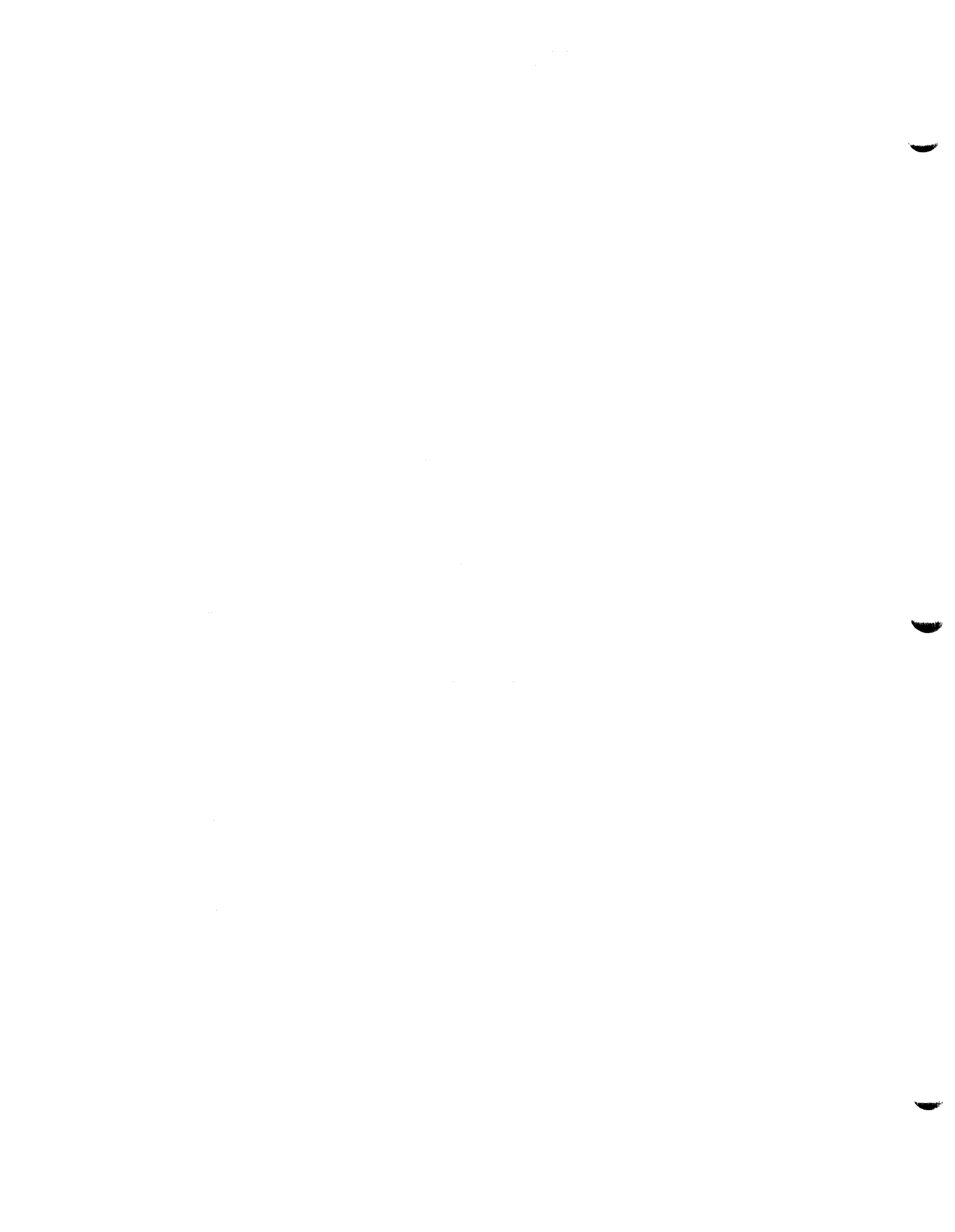

LIST OF EFFECTIVE PAGES

PAGE	REV	PAGE	REV	PAGE	REV
Cover	06	4-14	05	6-25	05
Blank	—	4-15	05	6-26	05
i	06	4-16	05	6-27	05
Blank	—	4-17	05	6-28	05
iii	06	4-18	05	6-29	05
Blank	—	4-19	05	6-30	05
v	05	4-20	05	6-31	05
vi	06	4-21	05	6-32	05
vii	05	4-22	05	7-1	05
viii	05	5-1	05	7-2	05
ix	05	5-2	05	7-3	05
Blank	—	5-3	05	7-4	05
1-1	03	5-4	05	7-5	05
1-2	03	5-5	05	7-6	05
2-1	03	5-6	05	7-7	05
2-2	05	5-7	05	7-8	05
2-3	06	5-8	05	7-9	05
2-4	03	5-9	05	7-10	05
2-5	05	5-10	05	7-11	05
2-6	05	5-11	05	7-12	05
2-7	05	5-12	05	7-13	05
2-8	05	5-13	05	7-14	05
2-9	03	5-14	05	7-15	05
2-10	05	5-15	05	7-16	05
2-11	05	5-16	05	7-17	05
2-12	05	5-17	05	7-18	05
2-13	05	5-18	05	7-19	05
2-14	05	6-1	05	7-20	05
2-15	05	6-2	05	7-21	05
2-16	05	6-3	05	7-22	05
2-17	05	6-4	05	7-23	05
2-18	05	6-5	05	7-24	05
2-19	05	6-6	05	7-25	05
2-20	05	6-7	05	7-26	05
3-1	03	6-8	05	7-27	05
3-2	03	6-9	05	7-28	05
3-3	03	6-10	05	7-29	05
3-4	03	6-11	05	Blank	—
4-1	05	6-12	05	8-1	06
4-2	05	6-13	05	8-2	06
4-3	05	6-14	05	8-3	06
4-4	06	6-15	05	Blank	—
4-5	05	6-16	05	Reader Comment Card	—
4-6	05	6-17	05	Blank	—
4-7	05	6-18	05	Cover	—
4-8	05	6-19	05		
4-9	05	6-20	05		
4-10	05	6-21	05		
4-11	05	6-22	05		
4-12	05	6-23	06		
4-13	05	6-24	05		



CONTENTS

CHAPTER 1	INTRODUCTION	1 - 1
1.1	Introduction	1 - 1
CHAPTER 2	SPECIFICATIONS	2 - 1
2.1	Printer Specifications	2 - 1
2.2	Ribbon Specifications	2 - 3
2.3	Installation Conditions	2 - 3
2.4	Optional Unit	2 - 6
2.5	Forms Specification	2 - 11
2.5.1	General note about forms	2 - 11
2.5.2	Dimensions	2 - 12
2.5.3	Multiple-part forms	2 - 15
2.5.4	Ambient conditions for forms	2 - 18
2.5.5	Purchase order for forms	2 - 18
2.6	Format Control Tape (FCT)	2 - 19
2.6.1	Medium quality	2 - 19
2.6.2	Dimensions	2 - 19
CHAPTER 3	CONFIGURATION	3 - 1
3.1	Mechanical Unit	3 - 2
3.2	Control Unit	3 - 3
CHAPTER 4	DPC-COMPATIBLE INTERFACE	4 - 1
4.1	Operation Outline	4 - 1
4.2	Interface Signals	4 - 2
4.2.1	Interface signal lines	4 - 2
4.2.2	Physical specifications of interface signals	4 - 6
4.3	Character and Control Codes	4 - 8
4.3.1	Character codes	4 - 10
4.3.2	Control codes	4 - 10
4.4	Format control	4 - 11
4.4.1	Definition of the top of forms (TOF) and the bottom of form (BOF)	4 - 11
4.4.2	Specification of a forms feed format	4 - 12
4.4.3	Skip and Space commands	4 - 19
CHAPTER 5	CENTRONICS-COMPATIBLE INTERFACE	5 - 1
5.1	Operation Outline	5 - 1
5.2	Interface Signals	5 - 2
5.2.1	Interface signal lines	5 - 2
5.2.2	Physical specifications of interface signals	5 - 8
5.3	Character and Control Codes	5 - 11
5.3.1	Character codes	5 - 12
5.3.2	Control codes	5 - 12
5.4	Format Control	5 - 14
5.4.1	Loading from the mainframe to the VFU	5 - 15
5.4.2	Loading from an FCT to the VFU	5 - 16
5.4.3	Format specification from the operator panel	5 - 16
5.5	VFU Commands	5 - 17
5.5.1	n-Line Skip command	5 - 17
5.5.2	Skip to Channel-n commands	5 - 18

CHAPTER 6	RS-232-C INTERFACE	6 - 1
6.1	Operation Outline	6 - 1
6.2	Interface Signals	6 - 4
6.2.1	Interface signal lines	6 - 4
6.2.2	Physical specifications of interface signals	6 - 8
6.3	Character and Control Codes	6 - 14
6.3.1	Character codes	6 - 16
6.3.2	Control codes	6 - 16
6.4	Message Protocols	6 - 19
6.4.1	XON/XOFF protocol	6 - 19
6.4.2	Reverse Channel line protocol	6 - 19
6.4.3	DTR line protocol	6 - 20
6.4.4	RTS line protocol	6 - 20
6.5	Commands	6 - 21
6.6	Printer Status	6 - 28
CHAPTER 7	PRINT BAND SPECIFICATIONS	7 - 1
7.1	Standard Print Band List	7 - 2
7.2	Standard Character Sets	7 - 2
7.3	Type Catalog	7 - 9
CHAPTER 8	SPECIFICATION LIST	8 - 1
8.1	Print Bands	8 - 2
8.2	Options	8 - 3
8.3	Expendable Supplies	8 - 3
8.4	Special Tools	8 - 3

ILLUSTRATIONS

Figure 1.1	M304x series line printer	1 - 2
Figure 2.1	Outer dimensions (with the forms rack)	2 - 4
Figure 2.2	Operation and maintenance area (with the forms rack)	2 - 5
Figure 2.3	Outer dimensions (with the powered stacker)	2 - 7
Figure 2.4	Operation and maintenance areas (with the powered stacker)	2 - 8
Figure 2.5	FCT unit	2 - 9
Figure 2.6	Paper puller	2 - 10
Figure 2.7	Forms	2 - 11
Figure 2.8	Curled forms	2 - 11
Figure 2.9	Forms container lids	2 - 12
Figure 2.10	Shape of the forms container	2 - 12
Figure 2.11	Leftmost and rightmost print positions	2 - 13
Figure 2.12	Dimensions relating to pin feed holes	2 - 13
Figure 2.13	Protrusion and separation of the outer layer at the perforation of multiple-part forms	2 - 14
Figure 2.14	Methods of fastening paper	2 - 15
Figure 2.15	Allowable incorrect alignment of multiple-part forms	2 - 16
Figure 2.16	Multi-part forms with layers of different thickness	2 - 17
Figure 2.17	Carbon paper covering pin feed holes	2 - 17
Figure 2.18	Self-adhesive label forms	2 - 18
Figure 2.19	Specifications of FCT	2 - 20
Figure 3.1	Printer configuration	3 - 1
Figure 3.2	Control unit	3 - 4
Figure 4.1	Basic operations	4 - 1
Figure 4.2	Print operation	4 - 2
Figure 4.3	Basic data transfer operation	4 - 5
Figure 4.4	Timing of signals in data transfer	4 - 5
Figure 4.5	DPC-compatible interface signal driver and receiver	4 - 6
Figure 4.6	DPC-compatible interface connector pin assignment (Amp type)	4 - 7
Figure 4.7	DPC-compatible interface connector pin assignment (Winchester type)	4 - 8
Figure 4.8	Timing of FCB data loading	4 - 12
Figure 4.9	Correspondence between FCB data channels and bits	4 - 13
Figure 4.10	Channels specified for a forms feed format	4 - 15
Figure 4.11	An example of FCT and forms feed format	4 - 17
Figure 4.12	An example of format specification from the operator panel	4 - 19
Figure 5.1	Basic operations	5 - 1
Figure 5.2	Character code transfer timing	5 - 5
Figure 5.3	Control code receive timing	5 - 5
Figure 5.4	DC1 code receive timing chart	5 - 6
Figure 5.5	DC3 code receive timing	5 - 7
Figure 5.6	Skip-15-Lines command receive timing chart	5 - 7
Figure 5.7	VFU data receive timing chart	5 - 8
Figure 5.8	Centronics-compatible interface signal driver/receiver ...	5 - 9

Figure 5.9	Centronics-compatible interface connector pin assignment	5 - 10
Figure 5.10	Loading the data in the VFU	5 - 15
Figure 6.1	RS-232-C interface circuit	6 - 2
Figure 6.2	RS-232-C interface signal transmitter and receiver	6 - 8
Figure 6.3	Reverse channel line-protocol (Drop DTR in START/STOP mode)	6 - 10
Figure 6.4	Reverse channel line-protocol (DTR Constant On mode)	6 - 10
Figure 6.5	XON/XOFF protocol (Drop DTR in START/STOP mode and Half-auplex mode)	6 - 11
Figure 6.6	XON/XOFF protocol (Drop DTR in START/STOP mode and Full-auplex mode)	6 - 11
Figure 6.7	DTR line protocol	6 - 12
Figure 6.8	RTS line protocol (Drop DTR in START/STOP mode)	6 - 12
Figure 6.9	Interface cable connector	6 - 13
Figure 6.10	RS-232-C interface connector pin assignment	6 - 14

TABLES

Table 2.1	Printer specifications	2 - 2
Table 2.2	Ribbon specifications	2 - 3
Table 2.3	Electrical specifications	2 - 3
Table 2.4	Environmental conditions	2 - 6
Table 2.5	Powered stacker specifications	2 - 6
Table 2.6	FCT unit specifications	2 - 9
Table 2.7	Perforation dimensions	2 - 14
Table 2.8	Recommended bond weight of forms	2 - 16
Table 4.1	DPC-compatible interface signal lines (Positive logic)	4 - 3
Table 4.2	Character (ASCII) and control codes	4 - 9
Table 4.3	Definition of the start code	4 - 13
Table 4.4	VFU data example	4 - 16
Table 4.5	Skip commands	4 - 20
Table 4.6	Space commands (15-line feed mode)	4 - 21
Table 4.7	Space commands (63-line feed mode)	4 - 21
Table 5.1	Centronics-compatible interface signal lines	5 - 3
Table 5.2	Character (ASCII) and control codes	5 - 11
Table 5.3	n-Line Skip commands	5 - 17
Table 5.4	Skip to Channel-n commands	5 - 18
Table 6.1	RS-232-C interface signal lines	6 - 1
Table 6.2	Operation by the RTS and CTS combination	6 - 7
Table 6.3	Printer statuses	6 - 9
Table 6.4	Character (ASCII) and control codes	6 - 15
Table 6.5	Commands and their control sequences	6 - 21
Table 6.6	Printer status	6 - 28



1.1 Introduction

The M304x series (M3040, M3041, M3042, and M3043) is Fujitsu's latest introduction of highly cost-effective line printers using a print band and designed for OEM applications. The printing speeds of M304x series models are 390, 750, 1090, and 1420 lpm for a 48-character set, and 300, 600, 900, and 1200 lpm for a 64-character set respectively.

The M304x series provides the following features:

Superb Print-quality: Improved print hammers assure excellent print quality on up to six-part forms.

High Reliability: By using simplified mechanical design, reduced adjustment requirements, and self-diagnosis function, high reliability is consistently guaranteed.

Compactness: Since the mechanical unit is divided into modules and control unit is controlled by microprocessors, operability has been improved and printer size has been reduced, resulting in compact installation space.

Commonality: Almost all mechanical and electric components are used in common in all M304x series models, minimizing parts inventory and reducing maintenance training costs.

Low Sound Level: By using a soundproofing structure, a sound pressure level of 55 dB A (in the ECMA condition) has been attained for all models.

Self-diagnosis: Thanks to the incorporation of microprocessors and sensors, diagnosis is performed immediately after power-on. Errors during printing are automatically indicated, enabling the operator to determine if the error is operator-correctable or requires customer engineer service. The microprocessor can also test printers offline.

Simple Print Band Interchange: Each printer can use up to four print bands; three standard ones, and one optional one.

Wide Variety of Options: The M304x series offers a variety of options to meet individual customer needs.

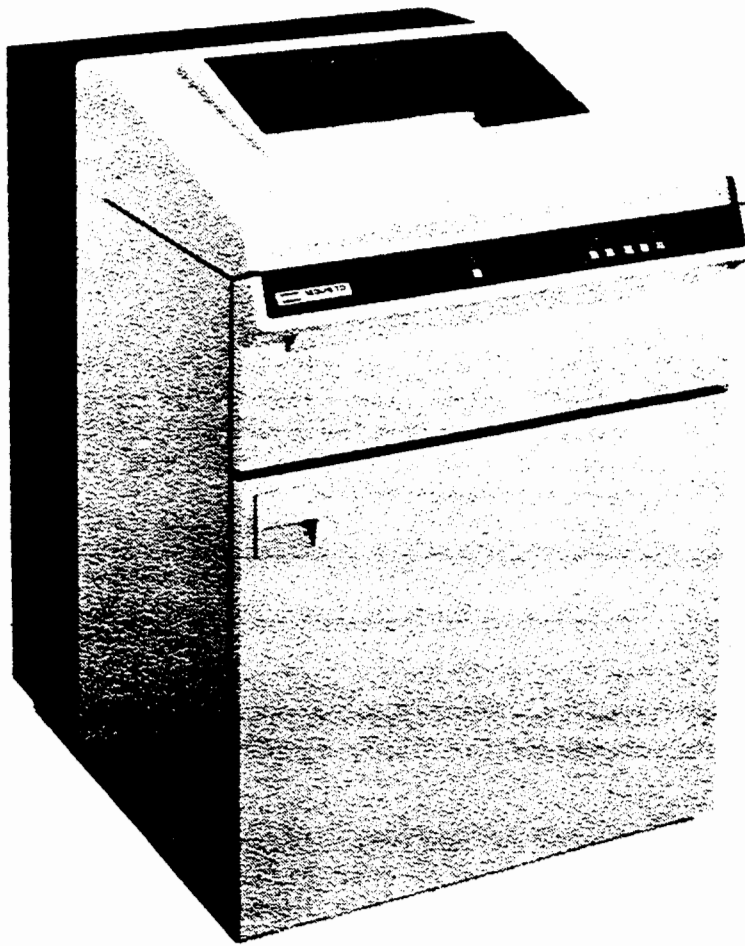

Figure 1.1 M304x series line printer

CHAPTER 2 SPECIFICATIONS

This section describes specifications of the M304x series line printers, ribbons, and forms.

2.1 Printer Specifications

Table 2.1 lists the printer specifications. For electrical specifications and ambient conditions, see Section 2.3. For standard interface specifications, DPC, Centronics or RS-232-C interface, see Chapter 4, 5, or 6.

Table 2.1 Printer specifications

Model		M3040	M3041	M3042	M3043
Item					
Print band	Type	48-, 64-, and 96-character sets (others optionally available)			
	Replacement	By operator			
Printing method		Continuously rotating print band struck by rotary hammers			
Printing speed	48-character set	390 lpm	750 lpm	1090 lpm	1420 lpm
	64-character set	300 lpm	600 lpm	900 lpm	1200 lpm
	96-character set	210 lpm	420 lpm	670 lpm	880 lpm
Print positions		80, 132 or 136 print positions per line (Selectable)			
Character spacing		2.54 mm (10 print positions per inch)			
Character set	48-character set	10 numerics, 26 upper-case alphabets, and 12 symbols			
	64-character set	10 numerics, 26 upper-case alphabets, and 27 symbols			
	96-character set	10 numerics, 26 upper-case and 26 lower-case alphabets, and 32 symbols			
Font type		Standard Gothic (others optionally available)			
Character code		ASCII (others optionally available)			
Number of copies	Carbonless copy paper	6 (Including original)			
	Forms with interleaved carbon paper and carbonbacked forms	5 (Including original)			
Sound pressure level		55 dB A (Conforms to ISO. DP7779 standard sound level)			
Forms feed rate	Line spacing time	18 ms (6 LPI)		14 ms (6/8 LPI)	
	Continuous feed	424.2 mm/s (16.7 inches/s)			
Vertical line spacing		4.23 or 3.18 mm (6 or 8 lines/inch)			
Format control tape (FCT) option		8- or 12-channel FCT is available.			
Interface		DPC, Centronics, RS-232-C, and other available options			
Dimensions (W x H x D) without powered stacker		700 mm (27.56") x 1095 mm (43.11") x 900 mm (35.43")			700 x 1095 x 960 (37.80")
Weight		180 kg (397 lbs)			200 kg (441 lbs)

2.2 Ribbon Specifications

This printer uses an endless cartridge type or open-type ribbon, which only moves in one direction. The ribbon is replaced by the operator. The ribbon specifications are as follows:

Table 2.2 Ribbon specifications

Item	Specification
Parts number	B87L-0840-0401A (black) B87L-0840-0402A (blue black)
Fabric	Nylon
Width	30 mm (1.18 inch)
Length	100 m (109 yards)
Ink	Black, blue black
Storage life	2 years

2.3 Installation Conditions

This section shows the outer dimensions, operation and maintenance area, electrical specifications, and environmental conditions of the printer.

Table 2.3 Electrical specifications

Item		Model	M3040	M3041	M3042	M3043
Primary voltage	UL/CSA version	100/110/115/200/220/230/240 VAC $\pm 10\%$				
	VDE version	200/220/230/240 VAC $\pm 10\%$				
Phase		Single phase				
Frequency		50 or 60 Hz $\begin{matrix} +2\% \\ -4\% \end{matrix}$				
Power consumption	When printing	48-character set 136-column printing	550 VA	700 VA	850 VA	1600 VA
		64-character 136-column printing	520 VA	630 VA	760 VA	1400 VA
	When not printing	250 VA				400 VA
Starting surge		50 A or less				75 A or less

M3040
M3041
M3042

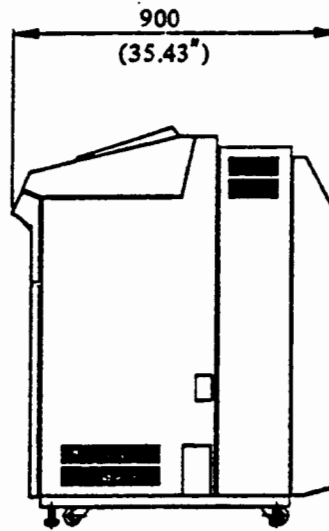
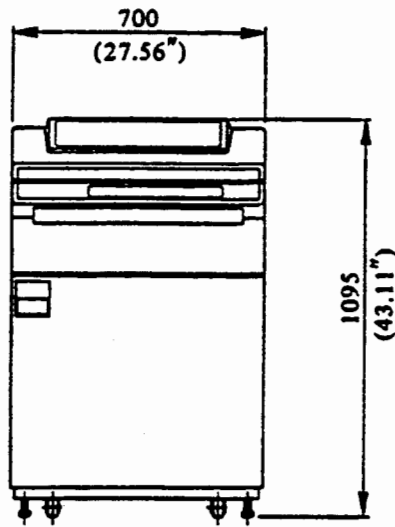

M3043

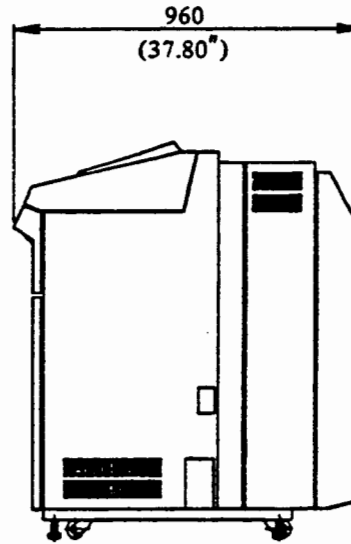
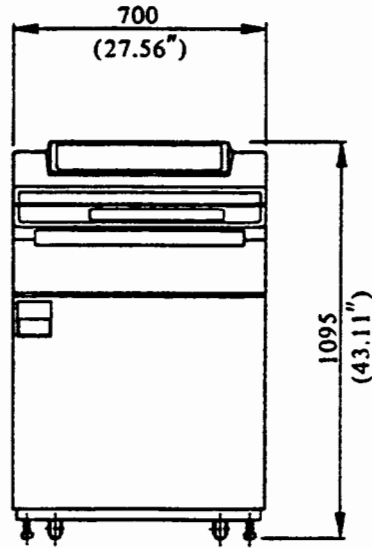
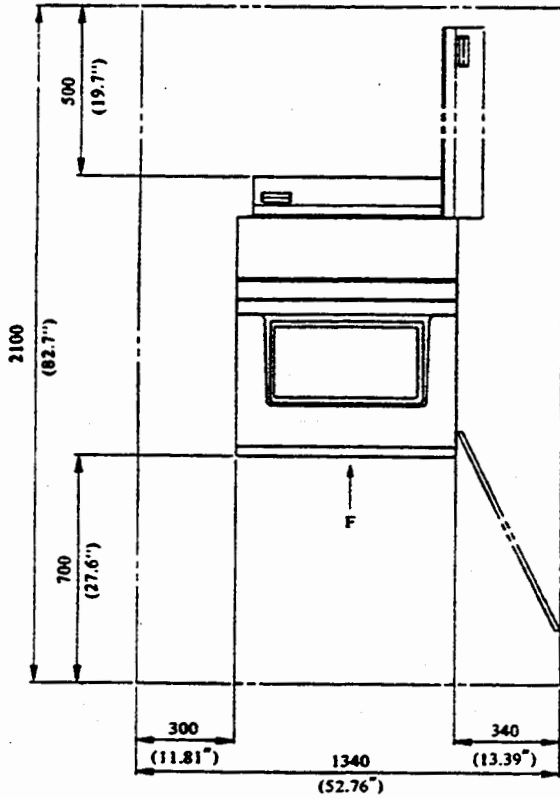
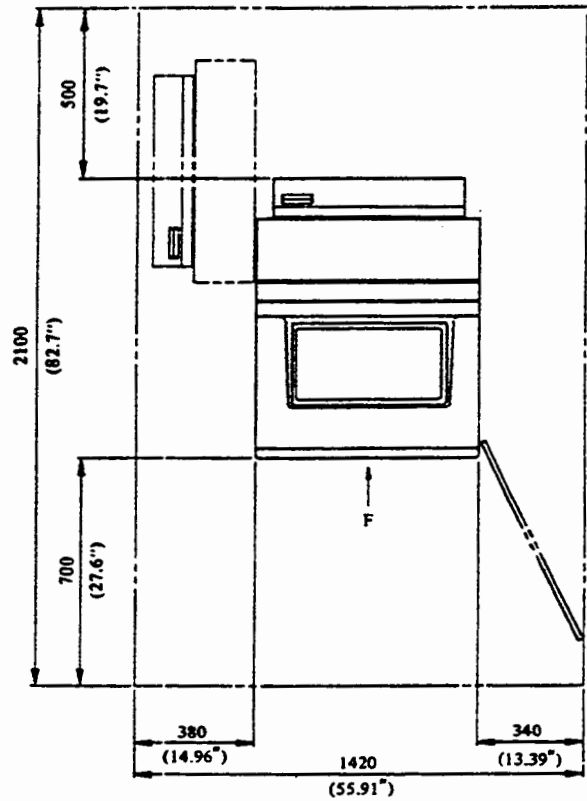

Figure 2.1 Outer dimensions (with the forms rack)

Operation area for M3040/M3041/M3042



Maintenance area for M3040/M3041/M3042



Operation area for M3043

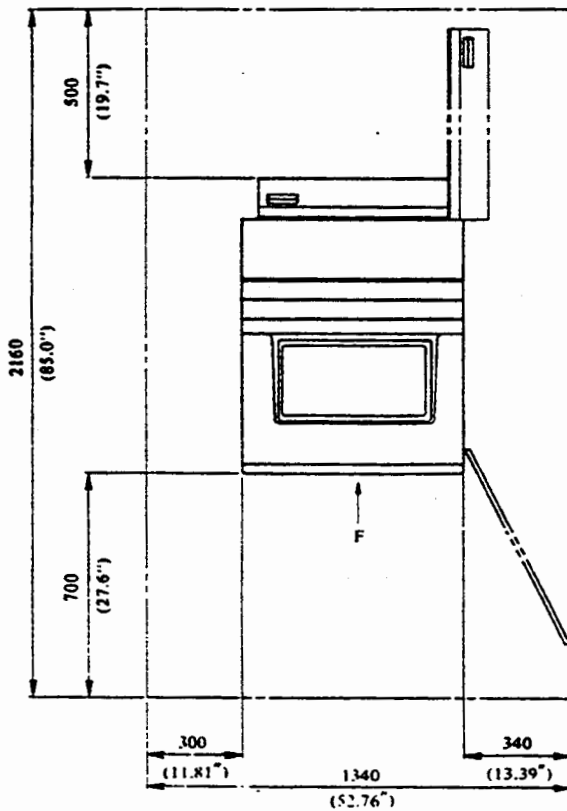

Maintenance area for M3043

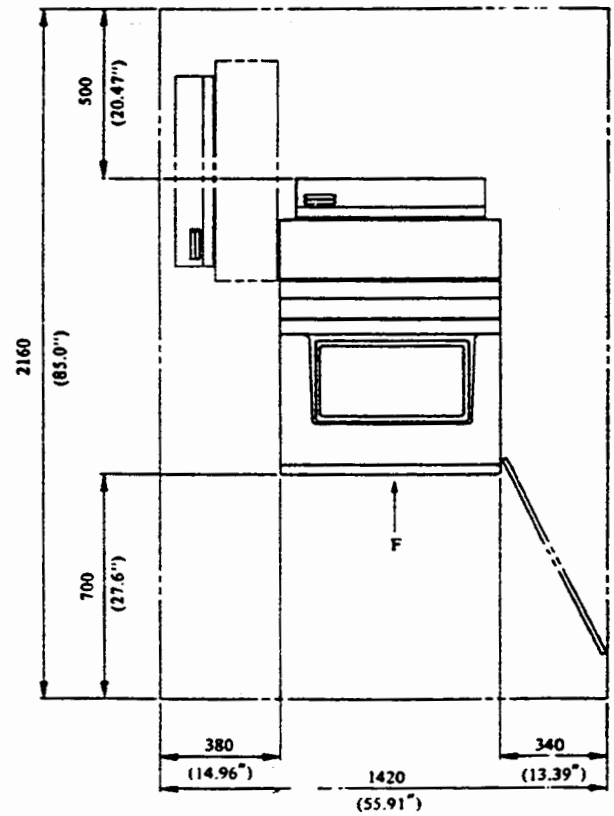

Figure 2.2 Operation and maintenance area (with the forms rack)

Table 2.4 Environmental conditions

Item			Condition			
			M3040	M3041	M3042	M3043
Ambient conditions	When operating	Temperature range	5°C to 40°C (41° to 104°F)			
		Relative humidity	20% to 80% RH			
		Maximum wet-bulb temperature	29°C (84.2°F)			
	When not operating	Temperature range	-20°C to 50°C (-4° to 122°F)			
		Temperature gradient	15°C/h (27°F/h) or below			
		Relative	10% to 90% RH (Without condensation)			
		Maximum wet-bulb temperature	29°C (84.2°F)			
	Heat dissipation (64-character set 136-column printing)			360 kcal/h	440 kcal/h	530 kcal/h
Air flow			5 m ³ /min			7 m ³ /min

2.4 Optional Unit

This section gives specifications of printer optional units such as the powered stacker, long-line interface unit, format control tape (FCT) unit, line counter, and paper puller.

(1) Powered stacker (B02B-1500-0005A)

The powered stacker enables folding and stacking of forms. Table 2.5 lists the powered stacker specifications. Figure 2.3 and 2.4 show the outer dimensions, and the operation and maintenance areas for printers with the powered stacker attached.

Table 2.5 Powered stacker specifications

Item		Specifications
Forms available for folding	Width	76.2 mm (3") to 431.8 mm (17")
	Length	177.8 mm (7") to 355.6 mm (14")
	No. of parts	1 to 5, 6 (only for carbonless paper)
Capacity		3000 sheets (1 part, 17 lbs./bond) maximum or forms stacked 32 cm high
Power consumption		60 VA maximum (powered stacker only)
Dimensions		700 mm (27.56") width x 960 mm (37.80") height x 417 mm (16.42") width
Weight		Powered stacker only: 60 kg (133 lbs.) M3040 to M3042 with powered stacker attached: 200 kg (441 lbs.) M3043 with powered stacker attached: 220 kg (485 lbs.)

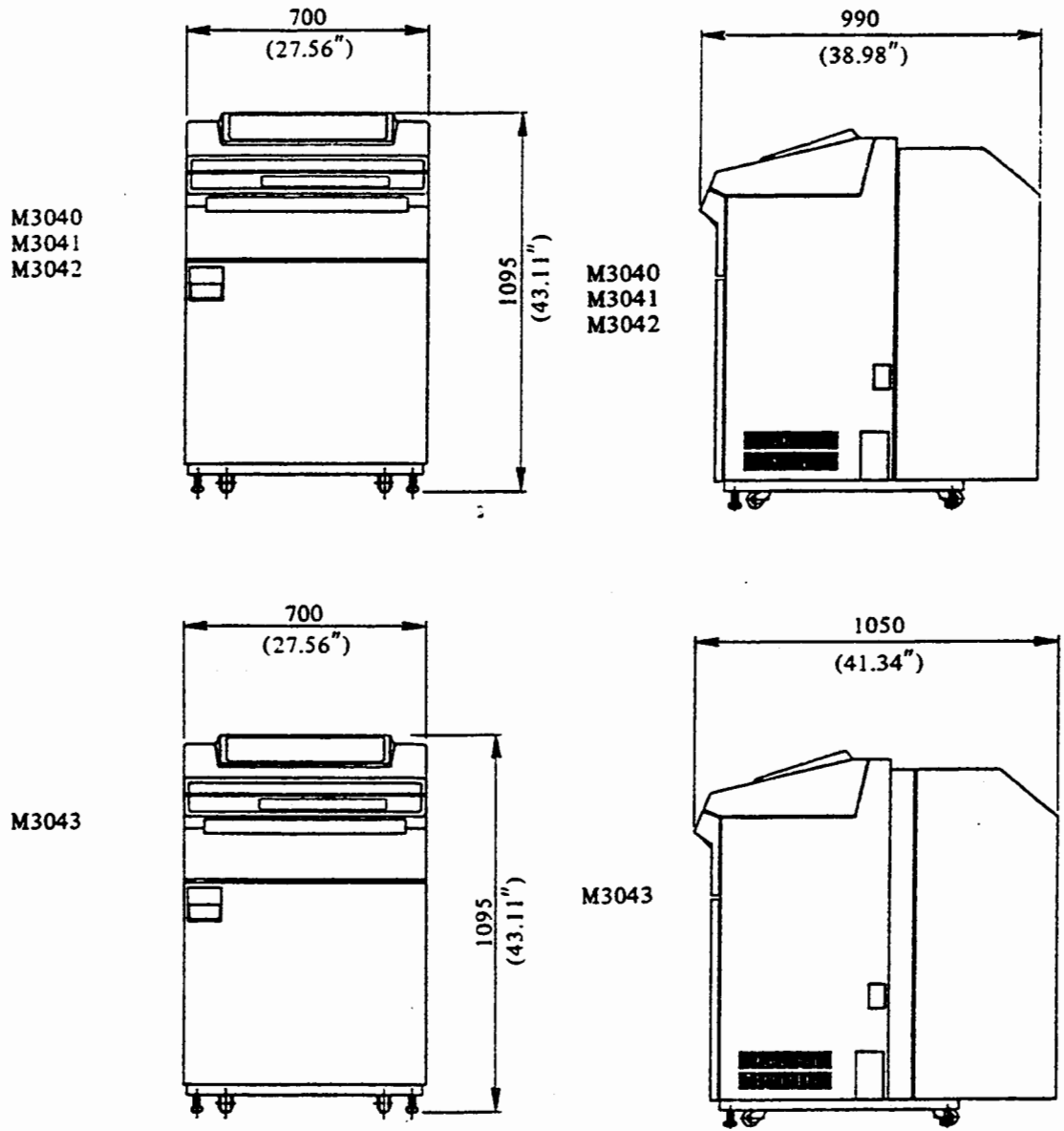
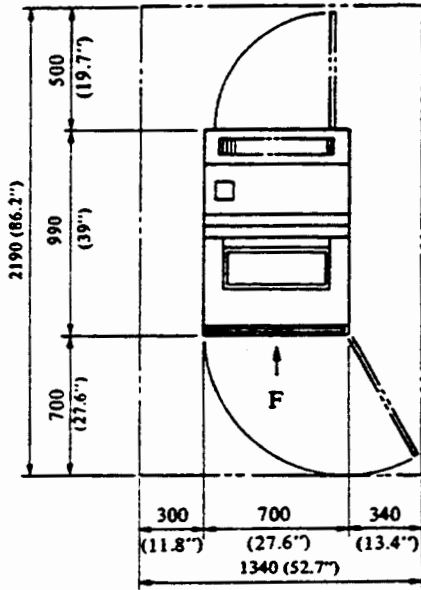

Figure 2.3 Outer dimensions (with the powered stacker)

The powered stacker can be operated using switches on the switch panel at the top of the stacker. For switch panel operation, refer to M304X Series Line Printer Operator's Guide.

Operation area for M3040/M3041/M3042
with powered stacker attached



Maintenance area for M3040/M3041/
M3042 with powered stacker attached

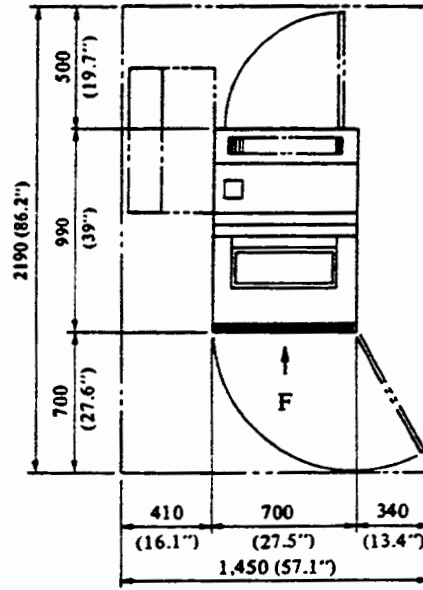

Operation area for M3043 with
powered stacker attached

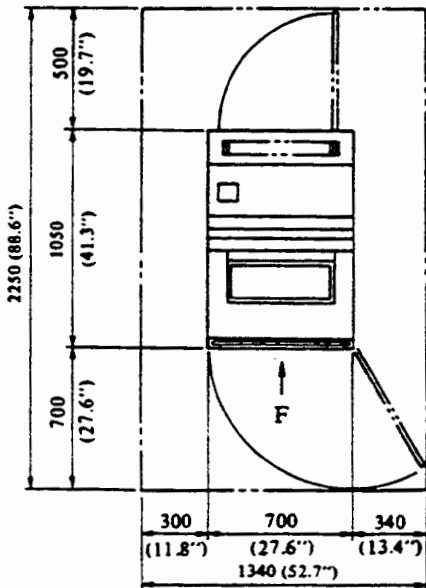

Maintenance area for M3043 with
powered stacker attached

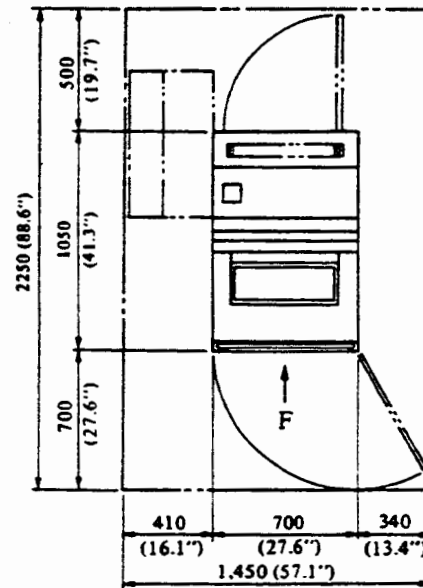

Figure 2.4 Operation and maintenance areas
(with the powered stacker)

(2) Long-line interface unit (B02B-1500-0004A)

The long-line interface unit can transmit and receive differential-mode interface signals via signal lines which can be up to 150 m in length.

(3) FCT units (B02B-1500-0002A/0003A)

The FCT unit reads format control data from the FCT and sends the data to the printer. Table 2.6 lists the FCT unit specifications. Figure 2.5 shows the FCT unit.

Table 2.6 FCT unit specifications

Item	Specification
Rated voltage	6 to 12 VDC
Current	0.4 A maximum
Tape speed	75 to 200 mm/s
Dimensions	To be supplied

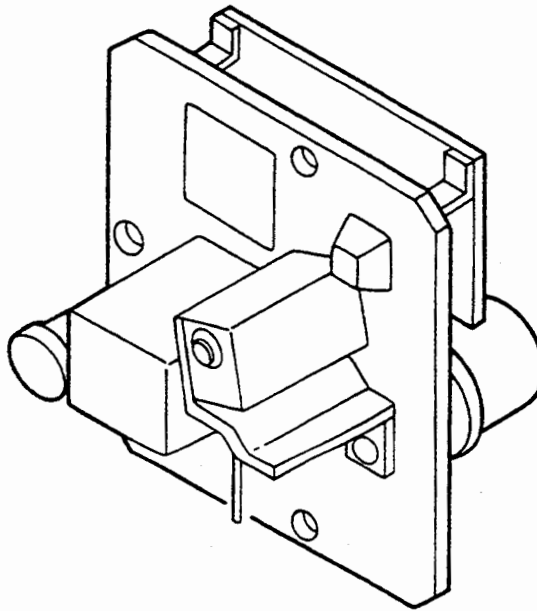

Figure 2.5 FCT unit

(4) Line counter (B02B-1500-0001A)

The line counter counts up by one every time 100 lines are printed.

(5) Paper puller (B02B-1500-0061A/0062A)

The paper puller, installed in the forms rack, pulls printed forms to improve forms folding.

The paper puller is supplied only as a parts kit (B02B-1500-0061A) or as an assembly (B02B-1500-0062A) with a forms rack. The paper puller is operated in the same way as the power stacker, that is, by using the panel installed at the upper part of the forms rack. For details, refer to M304X Series Line Printer Operator's Guide.

Figure 2.6 shows the paper puller.

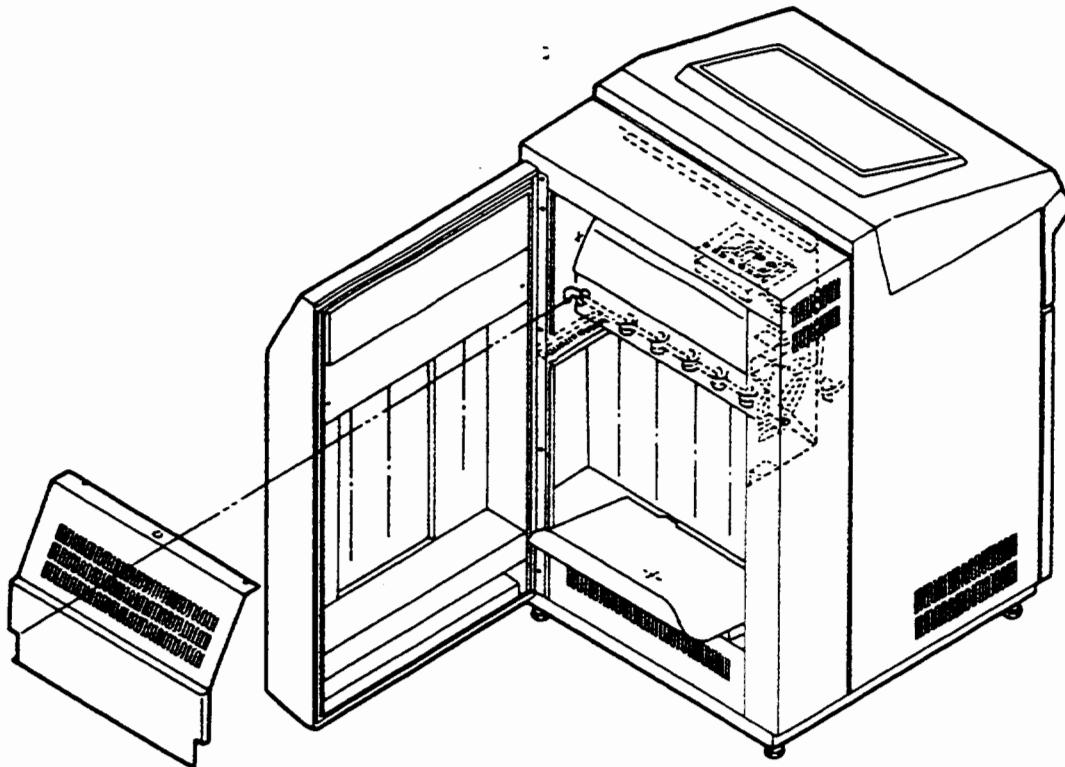

Figure 2.6 Paper puller

2.5 Forms Specification

Continuous fanfold forms, single copy or multiple copy, are used for the printers. The forms must have pin feed holes evenly lined up on both sides and horizontal perforations that run perpendicular to the forms feed direction. See Figure 2.7.

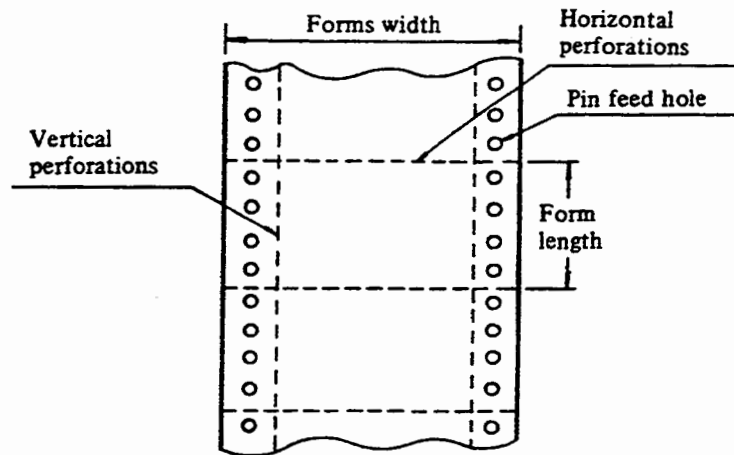

Figure 2.7 Forms

When selecting forms for this printer, the user must conform to the following forms specifications:

2.5.1 General note about forms

This section describes paper quality and shape of the forms container.

(1) Paper quality

Paper used for forms should be of good quality, opaque, not too elastic, and suitable for printing. The paper must also be free from dirt, wrinkles, and tears. Torn paper can cause printing trouble. Curled forms as shown in Figure 2.8 will not be fed or stacked correctly after printing. Do not use curled forms.

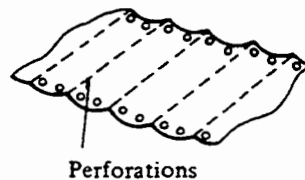

Figure 2.8 Curled forms

(2) Forms container

If the forms catch on container lids when being fed, feed errors may occur. Therefore arrange the lids as shown in Figure 2.9.

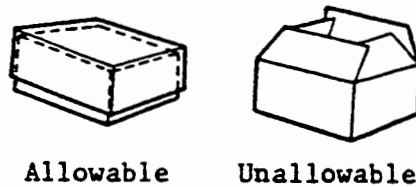

Figure 2.9 Forms container lids

Inside space between the forms and container should be 4 to 7 mm (0.16" to 0.28"). The bottom of the box must be flat. See Figure 2.10.

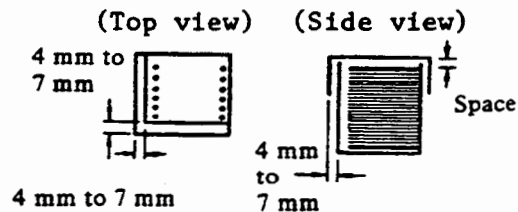

Figure 2.10 Shape of the forms container

The forms container height must be 330.2 mm (13") or less to be installed in the forms hopper.

If the form length or folding dimension is more than 15", the front and rear doors must be open during operation.

2.5.2 Dimensions

This section describes dimensions of the forms, printing area, pin feed holes, and perforations.

(1) Forms dimensions

Forms width: 76.2 to 431.8 mm (3" to 17")

Forms length: 76.2 to 381 mm (3" to 15")

(2) Positions and dimensions of the printing area

Figure 2.11 illustrates the distances between the leftmost and rightmost print-position centers of the printing area and the pin feed hole center.

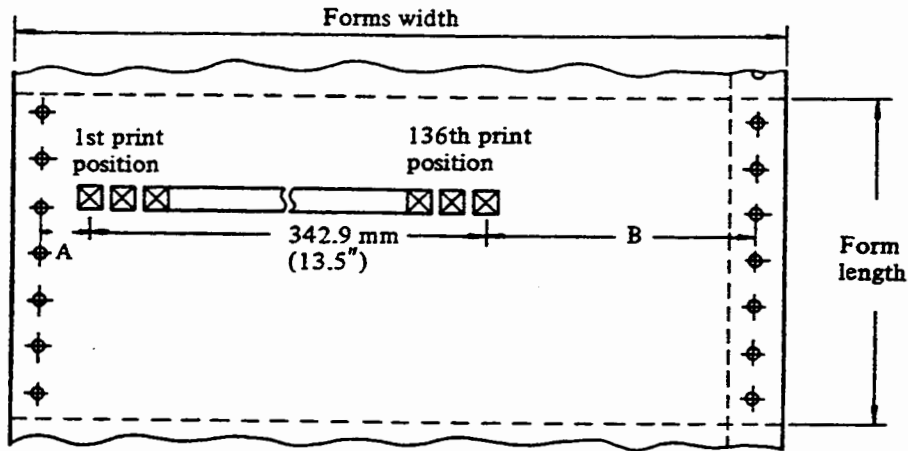

A- maximum: 63.5 mm (2.5")

B- maximum: 68.6 mm (2.7")

Figure 2.11 Leftmost and rightmost print positions

(3) Pin feed holes

Pin feed holes must be round. The dimensions relating to pin feed holes are given in Figure 2.12.

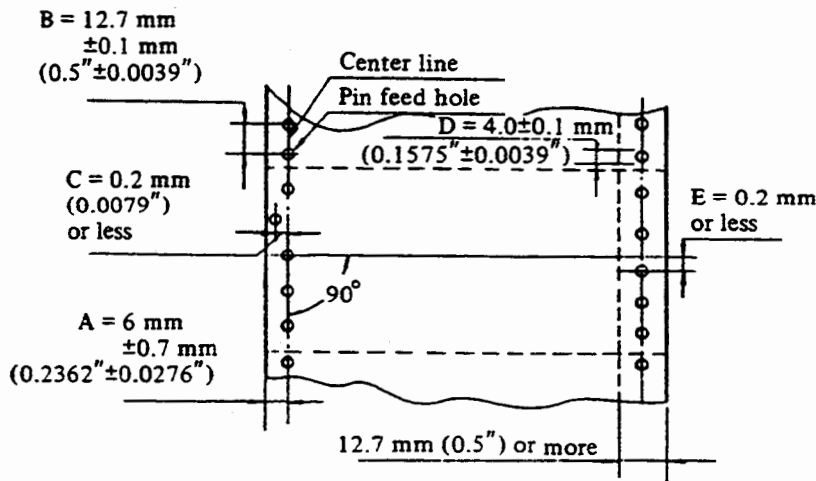

- A: Distance between the forms edge and pin feed holes.
- B: Distance between two consecutive pin feed holes.
- C: Misalignment of the pin-feed hole center with other holes.
- D: Diameter of a pin feed hole.
- E: Misalignment of the pin feed hole with a hole on the opposite side.

Note: The total misalignment of any two holes on opposite sides of forms along a 254 mm (10") length must not exceed 0.3 mm (0.0118").

Figure 2.12 Dimensions relating to pin feed holes

Poorly shaped pin feed holes and misalignment between left and right pin feed holes may result in inferior paper tensile strength. Misalignment must be within 0.2 mm (0.0079").

Pin feed holes that touch horizontal perforations may damage the paper. Pin feed holes must not overlap horizontal perforations.

Hanging hole chad will likely cause problems with the printer. Chad may stick to the printing area, resulting in printing cutoff characters. Do not use such forms.

(4) Perforations

Perforations must be straight. The perforations should be of the size shown in Table 2.7.

Table 2.7 Perforation dimensions

Tie/Cut ratio and dimension	Kind Designated mark Number layers	Dimension of horizontal perforations			Dimension of vertical perforations		
		Strong	Medium	Weak	Strong	Medium	Weak
Tie/Cut ratio	1	/	about 1:2	about 1:1	/	about 1:3	about 1:2
	2, 3, 4, and 5	about 1:3	about 1:2	/	/	about 1:3	about 1:2
Tie dimension	1, 2, 3, 4, and 5	0.7 mm (0.0276") to 3.0 mm (0.1181")					
Cut dimension	1, 2, 3, 4, and 5	1.2 mm (0.472") to 2.0 mm (0.0787")		1.2 mm (0.0472") to 3.0 mm (0.1181")			

Use weak or medium perforations shown in Table 2.7. The dimensions of horizontal perforation should be 2 mm (0.0787") or less. If the dimensions of horizontal perforations exceed 2 mm, the portion sticking out (h in Figure 2.13) at the cutting edge becomes large and feed error or forms damage may occur.

If separation at the perforations (fold) between each part is too great, the forms may be damaged or ink stain may result. The raised part at the fold (H in Figure 2.13) must be 2 mm or less with the bottom layer kept flat by force.

Figure 2.13 shows the protrusion and separation of the outer layer at the perforation of multiple-part forms.

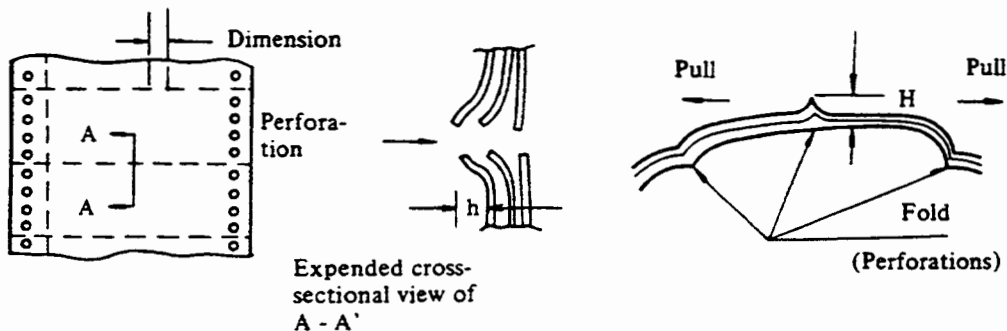

Figure 2.13 Protrusion and separation of the outer layer at the perforation of multiple-part forms

2.5.3 Multiple-part forms

This printer utilizes up to 6-part forms. Interleaved carbon paper utilizes 6-part forms and is not included in the number of parts. Forms with interleaved carbon paper, carbon-backed forms, and forms using carbonless copy paper are available as multiple-part forms. Each part of multiple-part forms must meet the specifications in Subsections 2.5.1 and 2.5.2. They must be of the same length and width.

This section describes the fastening, misalignment, and thickness of multiple-part forms and also how multiple-part forms cause feed defects.

(1) Fastening multiple-parts

Each part of multiple-part forms must be fastened together at one or both pin feed hole areas by gluing or crimping. Multiple-part forms with interleaved carbon paper should be fastened on the right. Staples must not be used on forms. If they are used, the printer print section will be damaged and a feed error will occur.

For gluing, do the following:

- . The shape of glued parts should be dots or stripes in the vertical direction, as shown in Figure 2.14.
- . Glue should be applied evenly and must not cause wrinkles or discolor the paper.
- . Do not apply glue to the perforations. If stripe gluing is necessary, the glue must not ooze through perforations of the top and bottom layers.
- . Glue cannot be used if forms lose pliability.

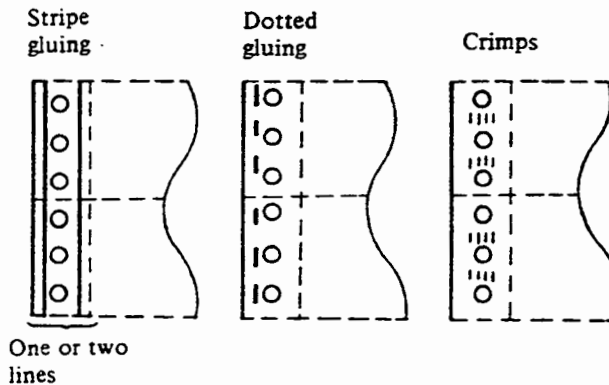

Figure 2.14 Methods of fastening paper

For crimping, do the following:

- . Layers must be firmly fastened and must not come loose.
- . There should be no paper tailings or dust.
- . Forms should maintain their shape so as not to cause jams.
- . Crimps must not overlap horizontal perforations. If crimps overlap horizontal perforations, the forms will tear at the perforation.
- . Crimps should not project through the bottom sheet.

If layers of multiple-part forms are not properly fastened, the layers are likely to peel apart, causing feed defects.

(2) Misalignment of paper

Misalignment between layers should be within the range shown in Figure 2.15.

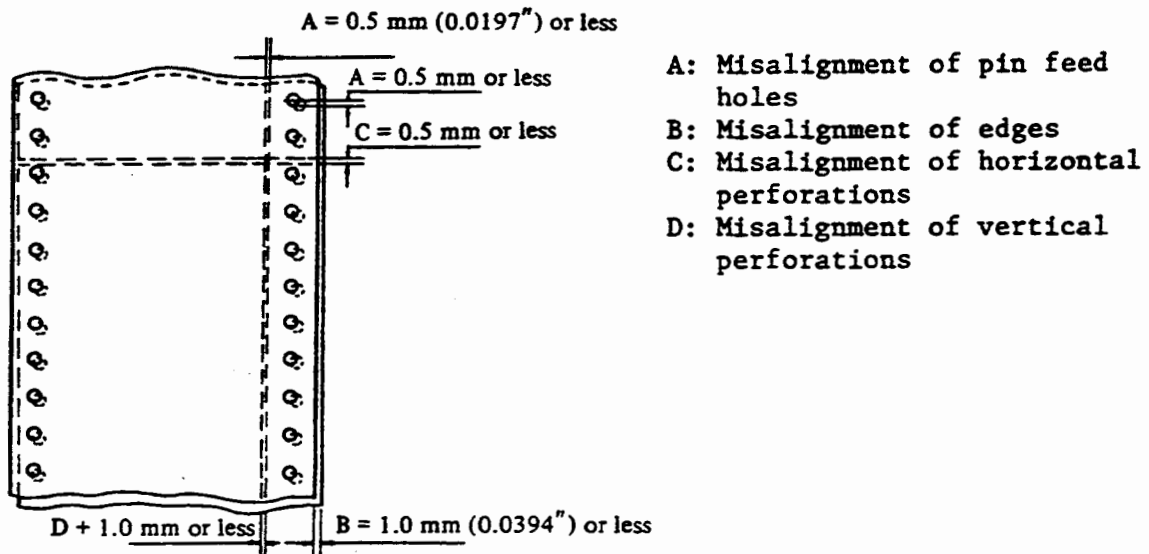

Figure 2.15 Allowable incorrect alignment of multiple-part forms

(3) Thickness of parts

Thickness of parts should be uniform. Thickness deviation in the print area must be within 0.076 mm (0.003"). Maximum total thickness of forms (including edges) is 0.6 mm (0.0236"). Table 2.8 indicates recommended bond weight of each layer according to forms type.

Table 2.8 Recommended bond weight of forms

Forms type	No. of parts	Bond weight (pound/bond)		
		Recommended	Minimum	Maximum
Single-part forms	1	17	15	28
Forms with inter-leaved carbon paper	2	14	125	17
	3, 4, and 5	12.5		14
Carbon-backed forms	2, 3, and 4	11	11	17
	5			11
Forms using carbonless copy paper	2 and 3	13	11	17
	4	11		
	5			11

When multiple-part forms are used, the forms can have different weights of parts (layers). However, the weight of each part should be that given in Table 2.8 according to the number of parts.

When forms are too thick, density fading between the top and bottom of each character will occur. When forms are too thin, they will be damaged and a feed defect will occur.

(4) Forms causing feed defects

The following forms are likely to cause feed defects, excluding those described before:

- . Multiple-part forms with layers whose thickness or number varies by section, such as shown in Figure 2.16.

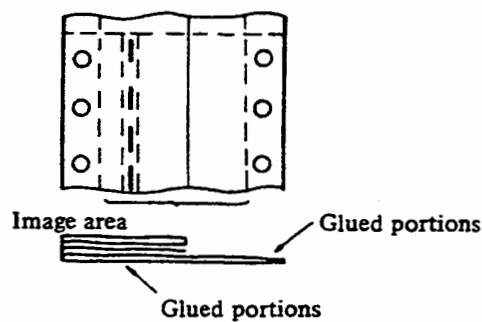

Figure 2.16 Multi-part forms with layers of different thickness

- . Multiple-part forms with layers glued in the print area (Printing should not be done on the glued portions.)
- . Carbon paper which is covering pin feed holes of multiple-part forms (see Figure 2.17.)

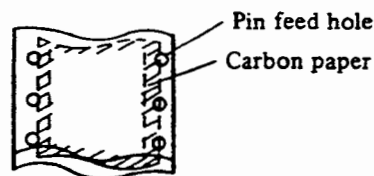

Figure 2.17 Carbon paper covering pin feed holes

- . Self-adhesive label forms with labels whose all sides are cut (see Figure 2.18)

Such forms are likely to peel off. The forms feed direction side of every label must be perforations to prevent peeling.

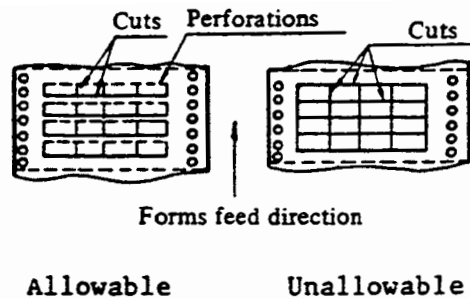

Figure 2.18 Self-adhesive label forms

2.5.4 Ambient conditions for forms

The following are the ambient conditions in storage and usage:

(1) Storage

Temperature should be with 10°C to 30°C and, relative humidity 30% to 70%.

(2) Usage

Temperature should be within 10°C to 30°C, and relative humidity 30% to 70%. If the conditions where it is stored and used are different, keep the paper for more than 48 hours in the environment where it will be used before using it.

2.5.5 Purchase order for forms

When ordering forms, specify the following items:

- Forms dimensions
- The number of parts
- Bond weight of each part
- Perforation position
- Perforation dimensions (tie and cut) for horizontal and vertical ones
- Carbon paper position (If carbon paper is used)
- Carbon-backed position (If carbon-backed paper is used)
- Fastening method for multiple-part forms
- Color of each part
- Type of carbon paper (If carbon paper is used)
- Carbon color (If carbon paper or carbon-backed paper is used)
- Copy color (If carbonless copy paper is used)
- Preprint on forms

For more detailed specifications, specify as required. When specifying special forms, prepare a sample in advance and test it. Order after confirming that it will work.

2.6 Format Control Tape (FCT)

The 8- and 12-channel format control tapes (FCT) are used for loading vertical format control data into the forms control buffer (FCB) of the printer using the FCT unit. FCTs must conform to the following FCT specifications:

2.6.1 Medium quality

Medium used for the FCT should be:

Total thickness: 0.100 to 0.110 mm (0.0039" to 0.0043")

Light transmittance: 5% or less

The FCT made up of a polyester resin film and paper would be stronger at tensile, tearing, and folding.

2.6.2 Dimensions

The FCT dimensions vary with the 8- and 12-channel FCTs. The dimension must be as shown in Figure 2.18.

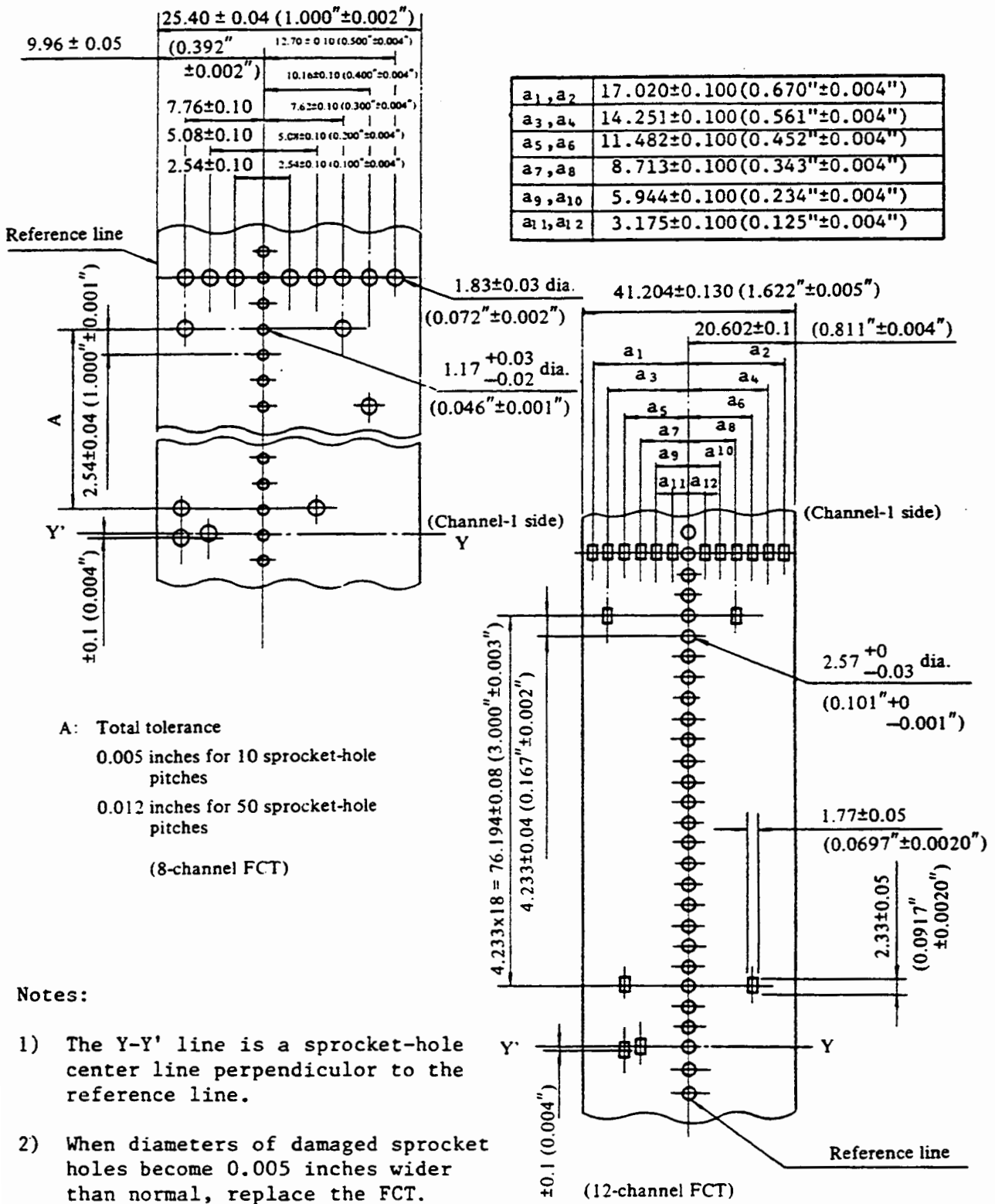

Figure 2.18 Specifications of FCT

CHAPTER 3 CONFIGURATION

The printer consists of the mechanical unit, control unit, forms rack, rear door and cabinet. The top cover and front door are included in the cabinet. The operator panel, control circuit board, and power supply are included in the control unit. Figure 3.1 shows their locations.

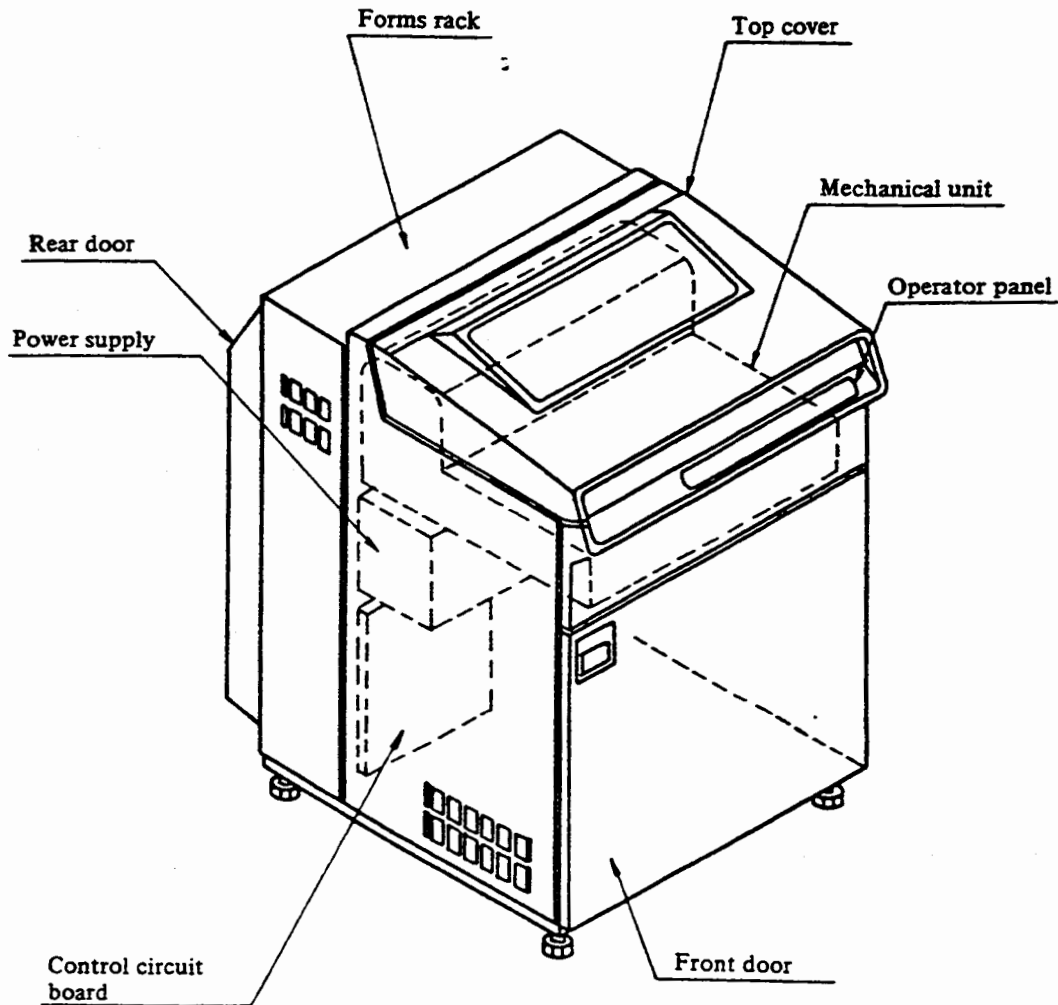

Figure 3.1 Printer configuration

3.1 Mechanical Unit

The mechanical unit consists of the following:

- . Base unit (includes the print-band drive section)
- . Print unit
- . Forms feed unit
- . Ribbon unit

(1) Base unit

The base unit is fixed to the cabinet frame. A platen, a print-band drive motor, a pair of band pulleys, and a variable-reluctance transducer for detecting each type location are in the base unit.

The print-band drive section has a simplified structure for easy print-band replacement by the operator.

(2) Print unit

The print unit is attached to the base unit and consists of four hammer magnet assemblies and a print unit frame.

The print unit can slide horizontally to the base unit by using a lever on the base unit to make the forms path wider so that an operator can easily load forms.

The hammer magnet assemblies consist of magnet assemblies and hammer assemblies, with hammers for 136 print positions. To improve print quality, rotary-type hammers are employed. Hammer magnet coils are arranged with sufficient space around them to ensure hammer-unit compactness.

(3) Forms feed unit

The forms feed unit is fixed to the print unit frame. A pair of forms tractors with a lever for adjusting their horizontal position, forms tractor drive mechanism, and a stepper motor to drive the unit are in the forms feed unit. The ADVANCE FORMS knob for adjusting the vertical forms position, and the SHIFT FORMS knob for adjusting horizontal forms position are also provided.

(4) Ribbon unit

The ribbon unit is fixed to the base unit. It consists of ribbon feed rollers, a ribbon feed motor, a ribbon feed sensor, ribbon guides, and a ribbon container.

3.2 Control Unit

The control unit consists of the following (see Figure 3.2):

- . Control circuit
- . Operator panel
- . Hammer magnet driver (with the register unit only for M3043)
- . Power supply

(1) Control circuit

The control circuit is on one PC board and is installed in the maintenance section, which can be accessed by opening the forms rack at the rear of the printer.

The control circuit uses 2 microprocessors; one for interface control and the other for printer control.

The LSI for print control reduces the number of parts and improves reliability.

(2) Operator panel

The operator panel is located at the upper front of the printer. Control switches and indicator lamps on the operator panel are on a PC board.

(3) Hammer magnet driver

The hammer magnet driver for the 136 magnets is on one PC board. In M3040, M3041, M3042, it is installed on the rear of the print unit and is connected directly to the magnet assembly on the PC board. In M3043, the hammer magnet driver is installed near the control circuit board and the lead from the magnet assembly is connected to the hammer magnet driver through the register unit.

A simple circuit is achieved by using custom ICs and a transistor array, enabling easy detection of faulty columns.

(4) Power supply

The power supply consists of the supply unit and a transformer.

The transformer is connected to an AC input through a line filter and a circuit breaker. Input voltages of 100 to 240 V can be selected by switching the appropriate tap on the transformer.

The power supply unit has regulation circuits for logic circuits and hammer magnet driving, a forms feed stepper motor drive circuit, and control relays for the AC motor.

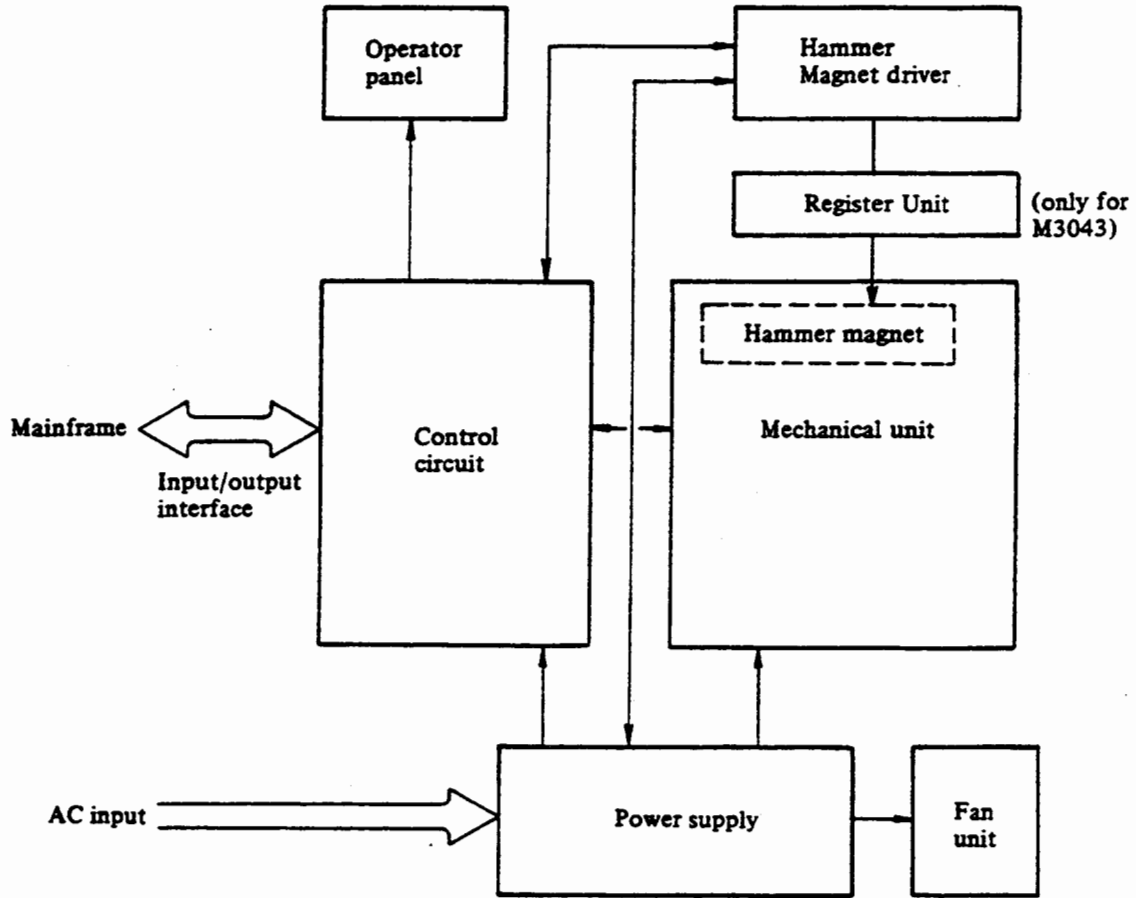

Figure 3.2 Control unit

This chapter describes the DPC-compatible interface used for the I/O interface connected to the M304x series line printer (printer).

4.1 Operation Outline

Basic printer operations, data transfer, printing, and forms feed are shown in Figure 4.1.

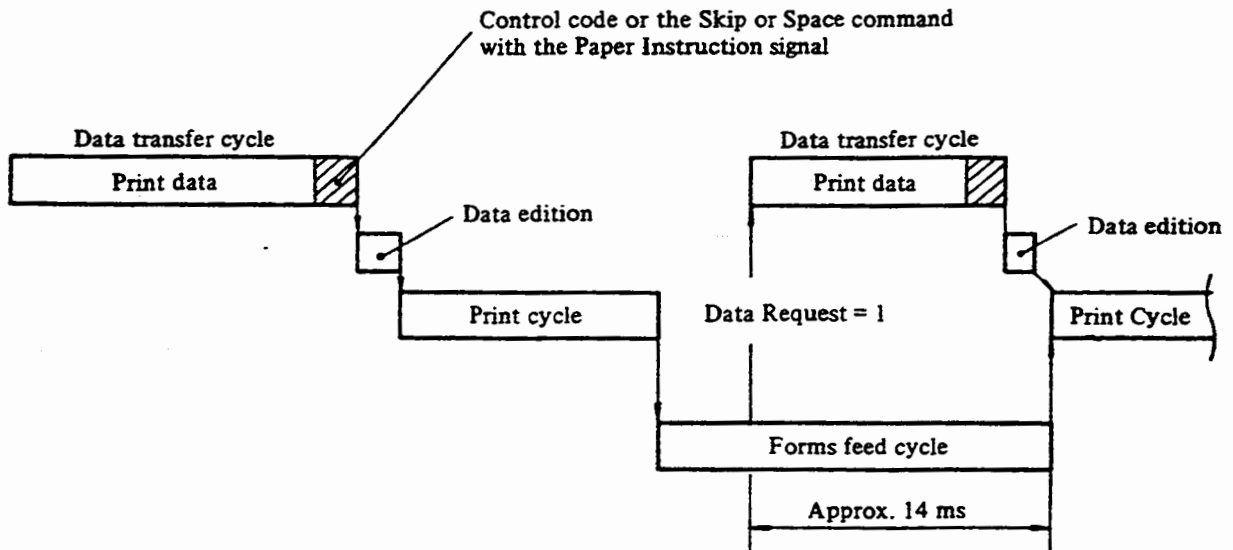

Figure 4.1 Basic operations

The printer starts the print cycle after receiving 1-line print data sent from the mainframe and one of the following:

- . Control code (LF, FF, or CR code)
- . Skip command (with the Paper Instruction signal = 1)
- . Space command (with the Paper Instruction signal = 1)

For the control codes and the Paper Instruction signal, see Sections 4.3.2 and 4.4.2. After 1-line printing, the printer starts the forms feed specified by the control code or with the Paper Instruction signal. The printer sets the Data Request signal to one 14 ms before terminating forms feed and starts receiving the next line of data during forms feed. Therefore, unless the next

line data is received within 14 ms, the print speed of the printer drops and does not achieve the rated print speed.

If the control code or the Paper Instruction signal is received without print data, the printer does not print and only feeds forms. If the received print data is more than 132 or 136 bytes (one of them is selectable), data of the 133rd, 137th or higher byte is ignored. If the received print data is less than 132 (or 136) bytes, the remaining data is printed as spaces.

The print operation above is shown in Figure 4.2.

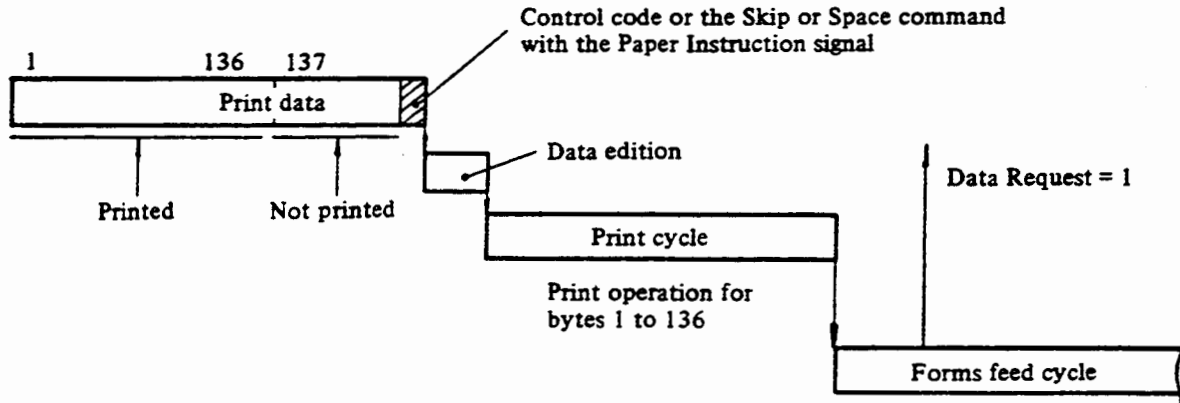

Figure 4.2 Print operation

4.2 Interface Signals

This section explains the interface signal functions and physical specifications.

4.2.1 Interface signal lines

Table 4.1 explains the DPC-compatible interface signal lines. Figures 4.3 and 4.4 show the timing chart of this interface and the timing specifications in data transfer respectively.

This printer has a print data buffer (PDB) for 136 characters. While a WMR signal and Online signal are being generated, print data is received according to the Figure 4.3. Printing starts after the following control code or Paper Instruction signal is received.

Table 4.1 DPC-compatible interface signal lines (Positive logic)

Signal name	Signal level (+)		Direction System ← Printer	Contents
	1	0		
Write Machine Ready (WMR)	5 V	0	←	This signal is high (logical 1) when the following conditions are satisfied for the printer: <ul style="list-style-type: none"> . Power has come on and all voltage levels are normal. . The print unit is closed. . The end of forms is not detected. . Initialization process has been completed. . The hammer drive system is normal. . An error is not detected.
Online	5 V	0	←	This signal enables information to be transmitted with the system connected to the printer and goes high when the following conditions are satisfied: <ul style="list-style-type: none"> . Write machine Ready (WMR) is 1. . The START/STOP switch is pressed. . The print band is rotating normally.
Data Request (DTRQ)	5 V	0	←	A synchronizing signal for data transferred from the system, and is high when data from the system can be accepted.
Write Strobe (WSB)	5 V	0	→	This is a strobe signal for Write Information to the printer. The printer resets its Data Request signal when the leading edge of this strobe signal is received.
Write Information 1-8 (WIF1-8)	5 V	0	→	This is the input data from the system. (For ASCII 7-bit codes, WIF8 can be ignored by setting.)
Buffer Clear (BCLR)	5 V	0	→	The data for one line stored in the buffer of the printer is cleared by this signal.
Connect 1 Connect 2	-	-	← →	This signal is used for confirming the connection of the interface connector. When the interface connector is connected, the Connect 1 and Connect 2 lines are connected.
Paper Instruction (PI)	5 V	0	→	This signal is high when forms control is performed by the system. When this signal is logical 1, the input data on the WIF lines is stored in the FCB. This signal is checked by the printer at the timing of the Write Strobe signal in the same way as WIF1 to WIF8. For details, see Section 4.4.2.

Table 4.1 DPC-compatible interface signal lines (Positive logic) - continued

Signal name	Signal level (+)		Direction System ↔ Printer	Contents															
	1	0																	
Write Information Parity (WIFP)	5 V	0	→	Even parity signal for data from mainframe. Odd parity is also available by setting. This signal can be ignored by setting.															
Write Check (++)	5 V	0	←	If a parity error occurs in WIF signals from the system, this signal is logical 1.															
Paper Moving (++)	5 V	0	←	This signal is logical 1 when the paper moves.															
Bottom of Form (++)	5 V	0	←	When the last line on a page is being printed, this signal is logical 1.															
Top of Form (++)	5 V	0	←	When the first line on a page is being printed, this signal is logical 1.															
IDENT 0 (++) IDENT 1	5 V	0	←	This signal indicates the type of print band. <table border="0"> <tr> <td>IDENT 1</td> <td>IDENT 0</td> <td></td> </tr> <tr> <td>0</td> <td>0</td> <td>Undefined</td> </tr> <tr> <td>1</td> <td>1</td> <td>48-character-set print band</td> </tr> <tr> <td>0</td> <td>1</td> <td>64-character-set print band</td> </tr> <tr> <td>1</td> <td>0</td> <td>96-character-set print band</td> </tr> </table>	IDENT 1	IDENT 0		0	0	Undefined	1	1	48-character-set print band	0	1	64-character-set print band	1	0	96-character-set print band
IDENT 1	IDENT 0																		
0	0	Undefined																	
1	1	48-character-set print band																	
0	1	64-character-set print band																	
1	0	96-character-set print band																	

+ Signal level 1 Active

Signal level 0 False

Negative logic is also available by setting (except for Connect 1/2 signals).

++ These signals can always be set 0 by setting.

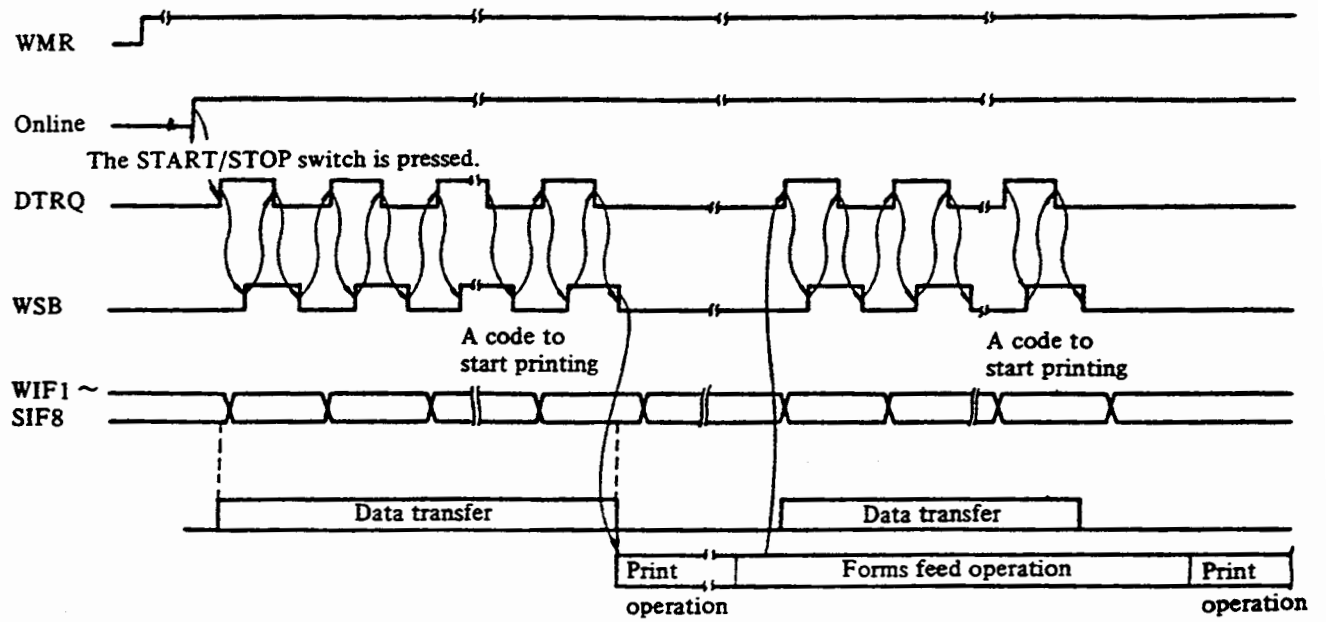

Figure 4.3 Basic data transfer operation

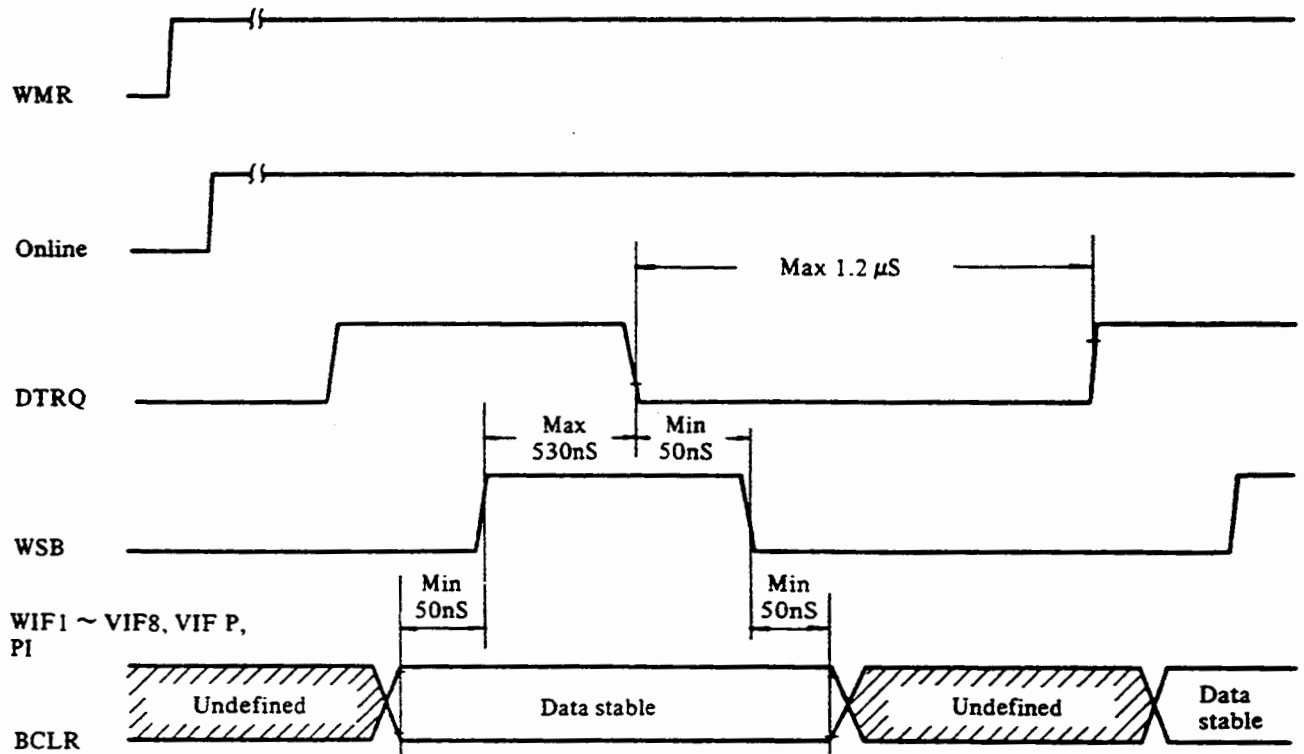

Figure 4.4 Timing of signals in data transfer

4.2.2 Physical specifications of interface signals

The physical specifications of DPC-compatible interface signals consist of electrical characteristics, interface cable specifications, and connector pin assignment specifications.

(1) Electrical characteristics

Signal levels must be within the following ranges:

Low level 0.0 to +4.0 V
High level +2.4 to +5.0 V

Note: The signal levels above are at the interface connector.
Incorrect signals may be sent in power-on and power-off.

The interface signal driver and receiver must be the same as those shown in Figure 4.5.

. Driver

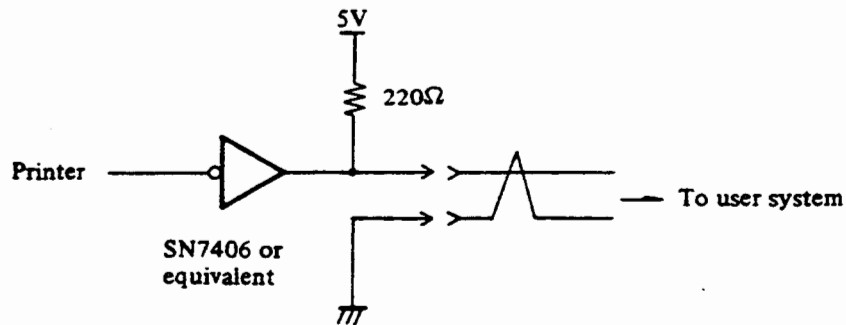

. Receiver

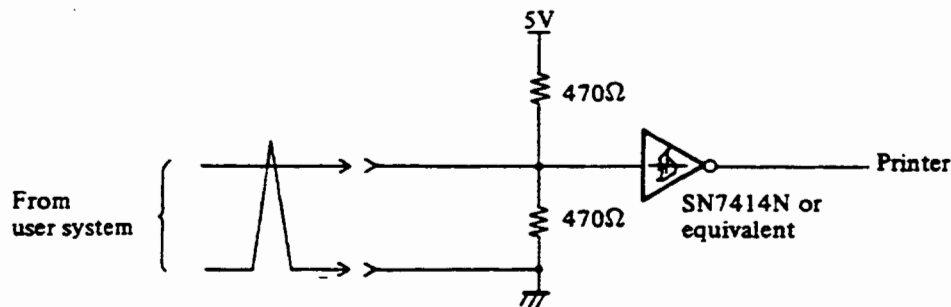

Figure 4.5 DPC-compatible interface signal driver and receiver

(2) Interface cable

Twisted pair cables with a shield must be used for the interface cable.
The cable length must be 50 feet (15 m) or less.

(3) Connectors and pin assignment

Either an Amp-type or Winchester-type connector is available for the interface connector of the printer. Figures 5.6 and 5.7 show Amp-type and Winchester type connector pin assignment.

No.	Signal name	No.	Signal name	No.	Signal name
1	WIF 3	18	(WIF5) RIN	34	WIF 5
2	(WIF 3) RIN	19	WIF 1	35	(WIF 7) RIN
3	(WIF 1) RIN	20	WIF 2	36	WIF 7
4	(WIF 2) RIN	21	Online	37	(Write Strobe) RIN
5	(Online) RIN	22	WMR	38	Write Strobe
6	(WMR) RIN	23	Data Request	39	-
7	(Data Request) RIN	24	Top of Form	40	(WIF 4) RIN
8	(Top of Form) RIN	25	Bottom of Form	41	WIF 4
9	(Bottom of Form) RIN	26	Paper Moving	42	(WIF 6) RIN
		27	Write Check	43	WIF 6
10	(Paper Moving) RIN	28	WIF 8	44	(WIF 8) RIN
11	(Write Check) RIN	29	WIF P	45	Connect 1
12	+5 V (max. 200 mA)	30	Paper Instruction	46	Connect 2
13	(WIF P) RIN	31	Buffer Clear	47	-
14	(Paper Instruction) RIN	32	(IDENT 0) RIN	48	-
15	(Buffer Clear) RIN	33	-	49	IDENT 1
16	(IDENT 1) RIN			50	IDENT 0
17	-				

Connector specifications

Amp 205740-1 or equivalent (Printer side)

Amp 205212-1, 66506-9, or equivalent (Cable side)

Figure 4.6 DPC-compatible interface connector pin assignment (Amp type)

		Buffer Clear	A		WIF 1	B
(Data Request) RTN	C			(WIF 1) RTN	D	
(Buffer Clear) RTN	H	Data Request	E	(WIF 2) RTN	J	WIF 2
		_____	K			
Bottom of Form	M			(WIF 3) RTN	N	WIF 3
		(Bottom of Form) RTN	P			L
Top of Form	S			(WIF 4) RTN	T	WIF 4
		(Top of Form) RTN	U			R
Paper Moving	W			(WIF 5) RTN	X	WIF 5
		(Paper Moving) RTN	Y			V
IDENT 1	a			(WIF 6) RTN	b	WIF 6
		(IDENT 1) RTN	c			Z
	e			(IDENT 0) RTN	f	IDENT 0
		_____	h			d
(WIF 7) RTN	k			(Write Strobe) RTN	m	Write Strobe
		WIF 7	n			j
Write Check	r			(Paper Instruction) RTN	s	Paper instruction
		(Write Check) RTN	t			p
Connect 1	v			(WIF 8) RTN	w	WIF 8
		Connect 2	x			u
WIF P	z			(Online) RTN	AA	Online
		(WIF P) RTN	BB			y
	DD			(WMR) RTN	EE	WMR
			FF			CC
						HH
					+5 V (max. 200mA)	

Connector specifications
MRA50S-D5J made by Winchester (Printer side)
MRAC50P-JTDH8 made by Winchester (Cable side)

Figure 4.7 DPC-compatible interface connector pin assignment (Winchester type)

4.3 Character and Control Codes

Table 4.2 shows character and control codes. In the table, areas enclosed with a bold faced line indicate control codes, whereas the other areas indicate character codes (ASCII codes). The table shows character codes of 8-bit mode. In 7-bit mode, character codes X'00' to X'7F' are available. Character codes with an asterisk in the table vary with the print band for each country, as shown in the lower table.

Table 4.2 Character (ASCII) and control codes

☐: Control code area

B ₈	→				0	0	0	0	0	0	0	0	1	1	1	1	1	1	1	
B ₇	→				0	0	0	0	1	1	1	1	0	0	0	0	1	1	1	1
B ₆	→				0	0	1	1	0	0	1	1	0	0	1	1	0	0	1	1
B ₅	→				0	1	0	1	0	1	0	1	0	1	0	1	0	1	0	1
B ₄	B ₃	B ₂	B ₁	L ^U	0	1	2	3	4	5	6	7	8	9	A	B	C	D	E	F
0	0	0	0	0	☐	☐	SP	0	@*	P	~*	P	☐	☐	☐	☐	☐	☐	☐	☐
0	0	0	1	1	☐	☐	!	1	A	Q	a	q	☐	☐	☐	☐	☐	☐	☐	☐
0	0	1	0	2	☐	☐	"	2	B	R	b	r	☐	☐	☐	☐	☐	☐	☐	☐
0	0	1	1	3	☐	☐	#*	3	C	S	c	s	☐	☐	☐	☐	☐	☐	☐	☐
0	1	0	0	4	☐	☐	\$*	4	D	T	d	t	☐	☐	☐	☐	☐	☐	☐	☐
0	1	0	1	5	☐	☐	%	5	E	U	e	u	☐	☐	☐	☐	☐	☐	☐	☐
0	1	1	0	6	☐	☐	&	6	F	V	f	v	☐	☐	☐	☐	☐	☐	☐	☐
0	1	1	1	7	☐	☐	'	7	G	W	g	w	☐	☐	☐	☐	☐	☐	☐	☐
1	0	0	0	8	☐	☐	(8	H	X	h	x	☐	☐	☐	☐	☐	☐	☐	☐
1	0	0	1	9	☐	☐)	9	I	Y	i	y	☐	☐	☐	☐	☐	☐	☐	☐
1	0	1	0	A	LF	☐	*	:	J	Z	j	z	☐	☐	☐	☐	☐	☐	☐	☐
1	0	1	1	B	☐	☐	+	;	K	{*	k	{*	☐	☐	☐	☐	☐	☐	☐	☐
1	1	0	0	C	FF	☐	,	<	L	*	l	*	☐	☐	☐	☐	☐	☐	☐	☐
1	1	0	1	D	CR	☐	-	=	M]*	m]*	☐	☐	☐	☐	☐	☐	☐	☐
1	1	1	0	E	☐	☐	.	>	N	~*	n	~*	☐	☐	☐	☐	☐	☐	☐	☐
1	1	1	1	F	☐	☐	/	?	0	_	o	☐	☐	☐	☐	☐	☐	☐	☐	☐

Note: Codes with an asterisk in the table above vary with the print band for each country as follows:

Code Country	X'23'	X'24'	X'40'	X'5B'	X'5C'	X'5D'	X'5E'	X'60'	X'7B'	X'7C'	X'7D'	X'7E'
U.S.A.	#	\$	@	[\]	-	~	{		}	-
U.K.	£	\$	@	[\]	-	~	{		}	-
France	£	\$	à	°	ç	§	-	~	é	ù	è	-
Germany	#	\$	§	Ä	Ö	Ü	-	~	ä	ö	ü	ß
Sweden	#	☉	É	Ä	Ö	Å	ú	é	ä	ö	å	ü
Denmark	#	\$	É	Æ	ó	Å	ú	é	æ	ó	å	ü

4.3.1 Character codes

The ASCII code is used as the standard character code.

If the printer receives a character code not specified in the character code table or not included on the print band, the code is changed to the space code (X'20') and no character is printed for the code. If a character code from X'A0' to X'FE' is received in 7-bit mode, the WIF8 signal can be ignored (regarded as 0) by setting, and a character corresponding to each code from X'20' to X'7E' is printed. For the setting method, refer to Operator's Guide.

When receiving character codes, the printer sequentially loads them in its internal buffer (IBF). Characters corresponding to the loaded character codes are printed after a control code is received. The IBF is cleared after printing. The character code received next is for column 1.

4.3.2 Control codes

The line feed (LF), form feed (FF), and carriage return (CR) codes are control codes indicated in the area enclosed with a boldfaced line in Table 4.2. The printer starts an operation, such as printing and forms feed when the control code is received.

(1) LF code (X'0A')

When receiving the LF code, the printer starts printing characters corresponding to the received character codes from column 1. After printing the characters, the printer spaces. If the number of character codes received before the LF code is less than 132 (or 136), the remaining characters are treated as spaces. If the LF code is received without character codes, the printer does not print, it only feeds forms.

(2) FF code (X'0C')

When receiving the FF code, the printer starts printing characters corresponding to the received character codes from column 1. After printing the characters, the printer feeds forms to the top-of-form (TOF) line, or if FCB data is loaded, to the line with channel 1.

If there is no channel 1 in the loaded FCB data, the printer feeds forms to the first line on the next page. For definition of the TOF and channel 1, see Section 4.4.1. If the number of character codes received before the FF code is less than 132 or 136, the remaining characters are treated as spaces.

If the FF code is received without character codes, the printer does not print, it only feeds forms. Even if the forms are positioned at the TOF or channel-1 line, the printer feeds forms to the next TOF or channel-1 line.

(3) CR code (X'0D')

When receiving the CR code, the printer starts printing characters corresponding to the received character codes from column 1. One of the following modes are available for the operation after printing:

- . Mode without forms feed

The printer does not feed forms after printing. When receiving the CR code without character codes, the printer does nothing.

- . Automatic spacing mode (IF code mode)

The printer spaces after printing. When receiving the CR code without character codes, the printer only spaces. The CR code is treated as the LF code in this mode.

One of the modes above is selectable by setting at the operator panel. For the setting method, refer to Operator's Guide.

(4) Undefined control codes

Control codes undefined in the control code area in Table 4.2 are treated as space codes.

4.4 Format Control

To control forms feed, in addition to control codes, the printer uses format control functions that specify the form (page) length and the page print format. These functions are as follows:

- . Forms control buffer (FCB)
- . Format control tape (FCT) unit option
- . Form length function

The FCB and the form length function are standard features of this printer. The FCT unit can be incorporated as an option.

When the FCT is not used, format control data is loaded from the mainframe (system) into the printer in online mode. When the FCT is used, format control data is loaded from the FCT unit into the printer in offline mode.

The format control data is indicated with channels which is used by software to specify special positions of the form.

4.4.1 Definition of the top of form (TOF) and the bottom of form (BOF)

The TOF and BOF are used for forms feed control.

(1) TOF

The TOF is defined as follows:

- . When the FCB data has been loaded, the TOF is the line to which channel 1 is first specified in the FCB data.
- . When the FCB data has not been loaded or when channel 1 is not contained in the FCB data, the TOF is the first line on the page.

(2) BOF

The BOF is defined as follows:

- . When the FCB data has been loaded, the BOF is the line to which the BOF channel is first specified in the FCB or FCT. (The BOF channel can be specified with any channel number at the operator panel. For the channel specification method, refer to Operator's Guide.)
- . When the FCB data has not been loaded or when the BOF channel is not contained in the FCB, the BOF is the last line on the form (page) without the skip-over perforation specification. That is, if the number of lines skipped to the perforation is specified using the skip-over perforation feature, the BOF is the last line not skipped. For the setting method of the skip-over perforation feature, refer to Operator's Guide.

4.4.2 Specification of a forms feed format

The forms feed information must be loaded into the FCB before forms feed, except when a control code, LF code, or CR code, is specified.

The FCB data is loaded from the mainframe via the I/O interface or from the optional FCT unit. The loaded FCB data is used for forms feed control by the FF code or by the Skip command transferred after print data.

Form (page) length and line spacing (6/8 LPI) are set at the operator panel. For the setting method, refer to Operator's Guide.

(1) Format specification by FCB

The format control data is loaded from the mainframe into the FCB of the printer in online mode. Figure 4.8 shows the timing of FCB data loading.

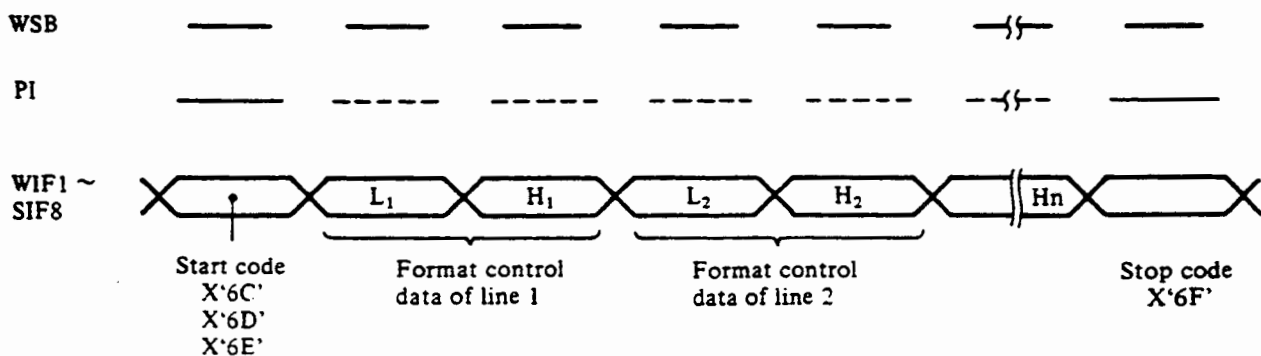

- Note:
- 1) The PI signal level indicated by dashed lines can be either high or low.
 - 2) The Ln and Hn indicate a low-order byte and a high-order byte.

Figure 4.8 Timing of FCB data loading

If the data code expressed by WIF1 to WIF8 is X'6C', X'6D', or X'6E' when the Paper Instruction signal is 1, the printer treats the data code as the start code for FCB data loading and loads into the FCB the data following the start code, until the printer receives the stop code X'6F'. The stop code is also sent with the Paper Instruction signal.

The transferred data is first loaded into the print data buffer (PDB) in the IBF. Then the interface control (IFC) microprogram loads the data into the FCB and knows the number of lines per page by counting the loaded FCB data bytes.

Table 4.3 shows the definition of the start code.

Table 4.3 Definition of the start code

WIF 8 7 6 5 4 3 2 1	Code (hex)	Operation	
0 1 1 0 1 1 0 0	6C	Line spacing is 6 lpi.	Six or eight lpi specification from the operator panel ignored.
0 1 1 0 1 1 0 1	6D	Line spacing is 8 lpi.	
0 1 1 0 1 1 1 0	6E	Forms are fed in 6/8 lpi when specified at the operator panel.	

Note: WIF8 is ignored and treated as 0 in 7-bit mode.

In Figure 4.8, $L_1H_1L_2H_2\dots L_nH_n$ ($2 \leq n \leq 255$) is the format control FCB data. Each L or H is one byte of data. Each pair of an L and H is format control data for one line on the form. L_1H_1 is data for line 1, L_2H_2 is data for line 2, and so forth. L_nH_n is data for the last line, and n indicates the total number of lines on a form (page.). The first byte (L) of the 2-byte line format data specifies a channel number from 1 to 6 and the second byte (H) specifies a channel number from 7 to 12. Figure 4.9 shows the correspondence between channels and WIF1 to WIF8.

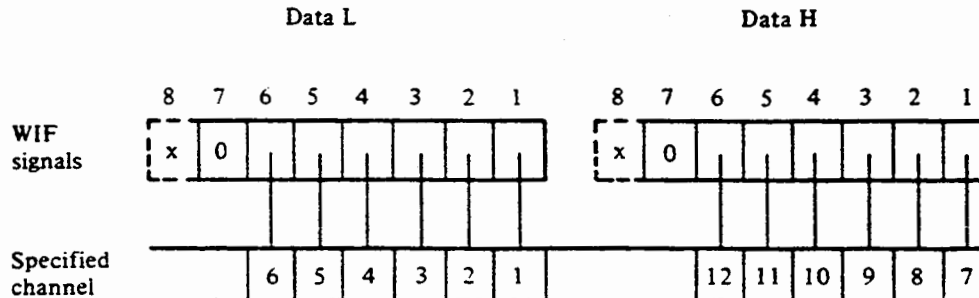

Note: X do not care. (In 8-bit mode)

Figure 4.9 Correspondence between FCB data channels and bits

Even if FCB data other than X'6F' (stop code) is received with WIF7 = 1, WIF7 is ignored (treated as 0) and WIF6 to WIF1 are treated as format control data and stored in the FCB. However, WIF7 should be 0, except when stop code X'6F' is used.

The total number of bytes contained in the FCB data $L_1H_1L_2H_2\dots L_nH_n$ must be even. If it is odd and the stop code X'6F' follows, an error occurs. At that time, the printer feeds forms determining that the H_n byte not received (data of channel 7 to 12) for the last line is X'00' and that the total number of lines on a form (page) is n lines.

If n is 1, an error occurs because there must be 2 or more lines on a page.

If n is greater than 255 -- that is, more than 255 lines are specified for a page -- an error occurs and data from the 256th line and after is lost because the FCB holds only 255 lines. The printer feeds forms for a maximum of a 255-line page, storing up to $L_{255}H_{255}$, which corresponds to line 255, in the FCB. The stop code is required because the printer continues FCB data loading until it receives this code.

FCB data must be loaded after character codes of a previous line are received, printed, and cleared because character codes are destroyed and data is loaded into the FCB incorrectly if the printer has unprinted character codes in the PDB before the FCB load start code.

Line 1 must be set to the print line of the printer before or immediately after FCB data loading because the FCB address counter is reset to 1 after FCB data is received (that is, the printer treats line 1 as the print line after FCB data is loaded).

If the printer receives start codes other than X'6C', X'6D' and X'6E', it feeds forms as though it had received a Skip or Space command.

Example of FCB data:

- . Line spacing: 6 lines/inch
- . Form length: 66 lines

Figure 4.10 shows the channels specified for a forms feed format.

Table 4.4 lists the FCB data. It is assumed that the BOF is set to channel 12 in the printer.

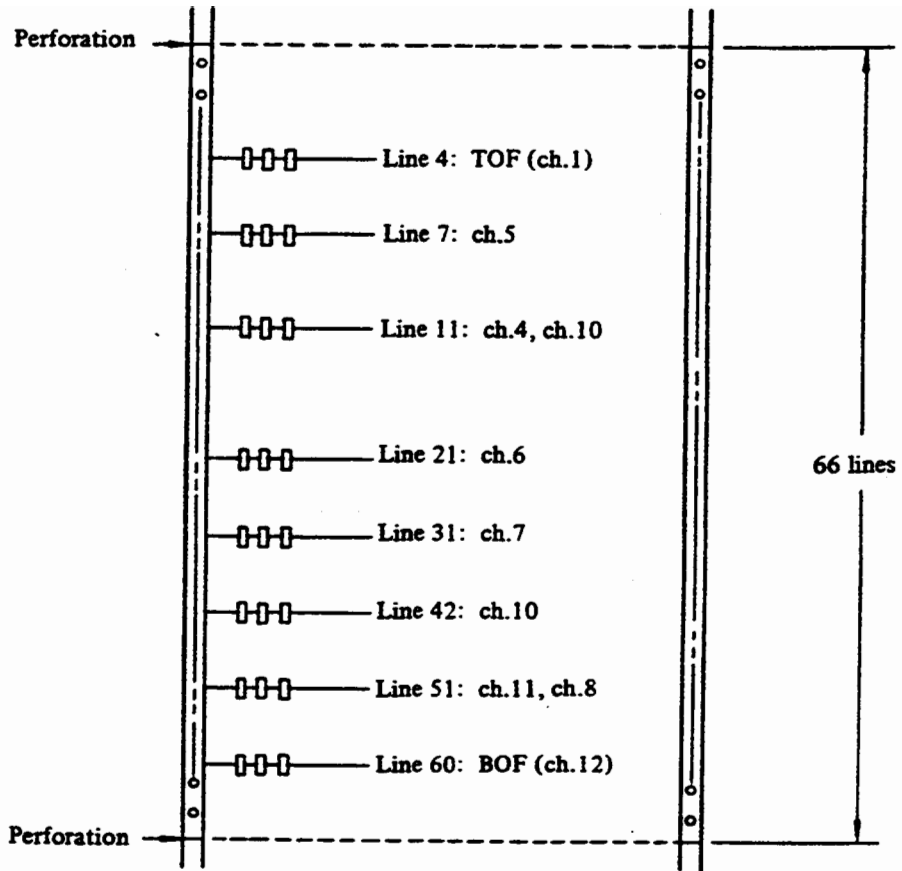

Figure 4.10 Channels specified for a forms feed format

Table 4.4 VFU data example

Data sequence	Data (hex)	Line	Channel											Data meaning		
			12	11	10	9	8	7	6	5	4	3	2		1	
1	6C															6 LPI, start code
2-7	00	1-3														
8	01	4													o	TOF (Channel 1)
9	00															
10-13	00	5-6														
14	10	7													o	Channel 5
15	00															
16-21	00	8-10														
22	04	11			o										o	Channels 10 and 4
23	08															
24-41	00	12-20														
42	20	21									o					Channel 6
43	00															
44-61	00	22-30														
62	00	31							o							Channel 7
63	01															
64-83	00	32-41														
84	00	42			o											Channel 10
85	08															
86-101	00	43-50														
102	00	51		o			o									Channels 11 and 8
103	12															
104-119	00	52-59														
120	00	60	o													BOF (Channel 12)
121	20															
122-133	00	61-66														
134	6F	-														Stop code

(2) Format specification by format control tape (FCT)

The FCT is a looped paper tape with punched holes and sprocket holes for feeding. The punched hole data is read by the FCT unit and sent to the printer to notify it of a forms feed format. Figure 4.11 is an example of the FCT and shows the relationship between a forms feed format and punched holes.

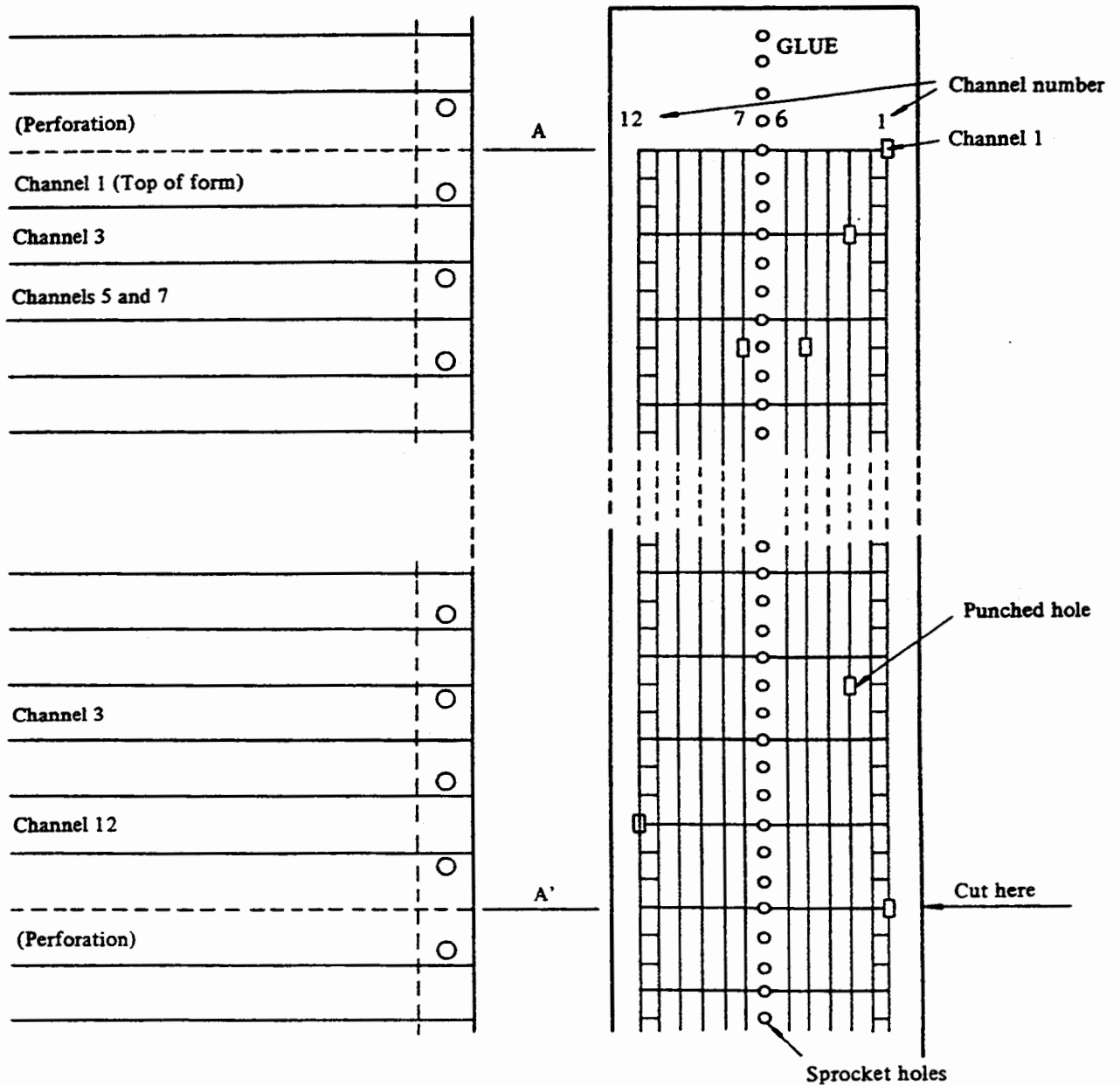

Figure 4.11 An example of FCT and forms feed format

There are 2 types of FCT: 8-channel and 12-channel. Figure 4.11 shows a 12-channel FCT, where each FCT sprocket hole corresponds to each line of the form. Punched holes, called channels, indicate special positions of the forms, and are used for forms feed control by software. This is the same as for 8-channel FCTs. When a new forms feed format is used, the old FCT must be replaced with one for the new forms feed format.

The FCT is read automatically when the printer is turned on or when the RUN switch on the FCT unit is pressed in offline mode. The RUN switch enables a new FCT to be read. Because the FCT unit determines that channel 1 of the FCT is the start position, the FCT unit reads punched hole data starting from channel 1 to the next channel 1 detected.

The data from the FCT unit is sent to the interface control (IFC) microprocessor. Then, the IFC microprogram loads the data into the FCB in the internal buffer.

Make an FCT as follows:

1. Punch a hole at the first column on the center line of the first sprocket hole (channel 1 as the top of form), as shown in Figure 4.11.
2. For subsequent lines, punch holes according to the forms feed format. Note that columns 1 to 12 (1 to 8 for an 8-channel FCT) correspond to channels 1 to 12 (1 to 8 for an 8-channel FCT). For example, punch a hole at the third column on the center line of the fourth sprocket hole when channel 3 is specified for the fourth line in the forms feed format. For more examples, punch holes at the fifth and seventh columns on the center line of the eighth sprocket hole when channels 5 and 7 are specified for the eighth line in the forms feed format. Figure 4.11 shows these examples.
3. Punch a hole at the first column (channel 1) on the sprocket-hole center line corresponding to the last line of the print form and cut the FCT there.
4. Align the center lines of the first sprocket hole (A in Figure 4.11) and the last sprocket hole (A' in Figure 4.11) of the FCT, glue these ends together, and confirm that no punched holes are covered.

- Notes:
- 1) Because channel 1 is defined as the BOF, there must be one hole, which indicates channel 1, per print form.
 - 2) The FCT should not exceed 255 lines.
 - 3) An FCT must be longer than 10 inches so that the FCT can be installed in the FCT unit. When the form length is less than 66 lines for a 12-channel FCT (100 lines for an 8-channel FCT), the same hole pattern must be repeated once on the FCT to extend the FCT length.
 - 4) The FCT used for this printer must conform to the specifications shown in Section 4.5.

(3) Format specification from the operator panel

The number of lines per page is used to specify the page length at the operator panel. Thus, a page length specified with 6 LPI differs from that specified with 8 LPI even if the form is the same length.

The number of lines skipped to avoid printing on or too near a perforation is also specified at the operator panel. (Skip-over perforation feature) For the setting method, refer to Operator's Guide.

Figure 4.12 is an example of format specification from the operator panel.

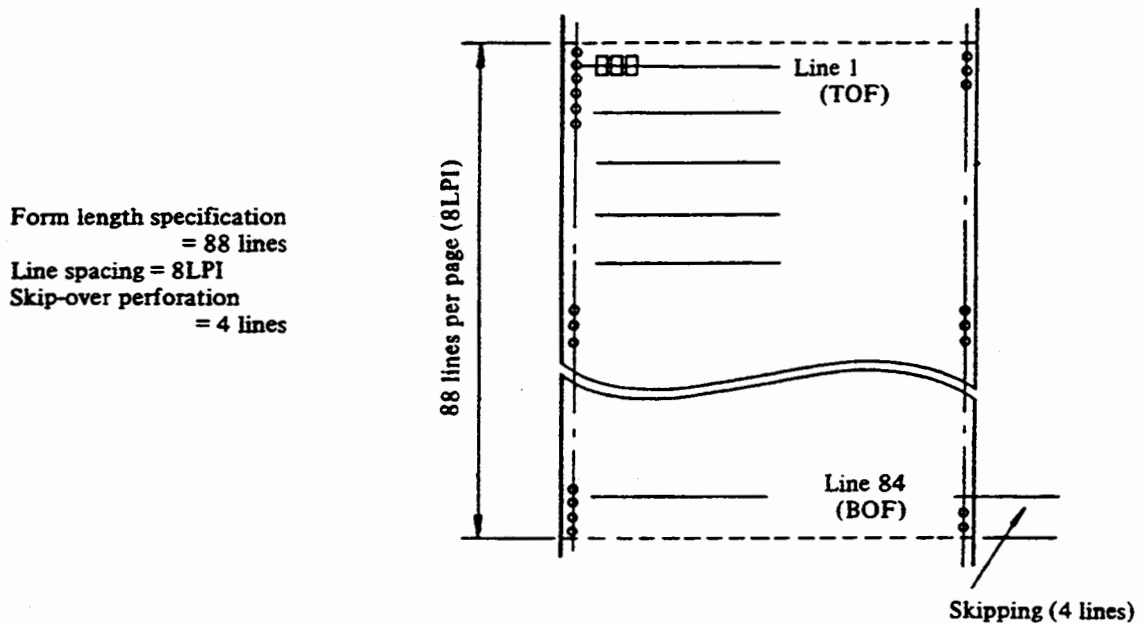

Figure 4.12 An example of format specification from the operator panel

4.4.3 Skip and Space commands

The Skip or Space command sent via the I/O interface controls forms feed. The Skip or Space command is sent with the Paper Instruction signal after print data is sent.

(1) Skip command

Skip commands feed forms up to the line corresponding to the channel specified in the format control data (in the FCB) after printing. If data WIF1 to WIF8 sent with the Paper Instruction signal is the same as that shown in Table 4.5, the printer (IFC microprogram) determines that the data indicates a Skip command. The relationship between Skip command data and specified channel numbers is shown in Table 4.5.

Table 4.5 Skip commands

WIF data 8 7 6 5 4 3 2 1	Hex.	Specified channel
X X X 0 0 0 0 0	00	Channel 1
X X X 0 0 0 0 1	01	Channel 2
X X X 0 0 0 1 0	02	Channel 3
X X X 0 0 1 0 0	03	Channel 4
X X X 0 0 1 0 1	05	Channel 5
X X X 0 0 1 1 0	06	Channel 6
X X X 0 0 1 1 1	07	Channel 7
X X X 0 1 0 0 0	08	Channel 8
X X X 0 1 0 0 1	09	Channel 10
X X X 0 1 0 1 0	0A	Channel 11
X X X 0 1 0 1 1	0B	Channel 12
X X X 0 1 1 0 0	0C	Error (no specified channel)
X X X 0 1 1 0 1	0D	
X X X 0 1 1 1 0	0E	
X X X 0 1 1 1 1	0F	

X: Do not care.

After the printer receives a Skip command and prints all characters in the PDB, the printer feeds forms up to the line with the specified channel number. If the Skip command is received before the 132nd (or 136th) character code, the remaining characters are treated as spaces. If the Skip command is received without character codes, the printer does not print, it only feeds forms.

If there are several channels with the same channel number in the FCB, after printing, the printer feeds forms up to the nearest line with the specified channel number. Therefore, if the forms are positioned at the line with the specified channel, the printer feeds forms up to the next line that has the same channel number specified.

Even though signals WIF6 to WIF8 are ignored, if the WIF data is X'6C', X'6D' or X'6E' (the start code for FCB loading), the data is treated as an instruction to start FCB loading. Thus, WIF6 to WIF8 must be 0, however,

WIF8 is ignored in 7-bit mode. WIF5 must be 0 because WIF5 indicate Space commands.

If no channels are specified in the FCB, the printer detects an error and only prints, it does not feed forms. Because commands X'0C' to X'0F' specify invalid channels, the printer detects them as errors.

(2) Space commands

Space commands feed forms the specified number of lines after printing. If data WIF1 to WIF8 sent with the Paper Instruction signal is the same as the that shown in Tables 4.6 and 4.7, the printer (IFC microprogram) determines that the data indicates a Space command. The relationship between Space command data and the number of lines fed is shown in Tables 4.6 (15-line feed mode) and 4.7 (63-line feed mode).

Table 4.6 Space commands (15-line feed mode)

WIF data 8 7 6 5 4 3 2 1	Hex.	No. of lines fed
X X X 1 0 0 0 0	10	0
X X X 1 0 0 0 1	11	1
X X X 1 0 0 1 0	12	2
X X X 1 0 0 1 1	13	3
⋮	⋮	⋮
X X X 1 1 1 1 0	1E	14
X X X 1 1 1 1 1	1F	15

Table 4.7 Space commands (63-line feed mode)

WIF data 8 7 6 5 4 3 2 1	Hex.	No. of lines fed
X 0 0 1 0 0 0 0	10	0
X 0 0 1 0 0 0 1	11	1
X 0 0 1 0 0 1 0	12	2
⋮	⋮	⋮
X 0 0 1 1 1 1 1	1F	15
X 0 1 1 0 0 0 0	30	16
X 0 1 1 0 0 0 1	31	17
⋮	⋮	⋮
X 0 1 1 1 1 1 1	3F	31
X 1 0 1 0 0 0 0	50	32
X 1 0 1 0 0 0 1	51	33
⋮	⋮	⋮
X 1 1 1 1 1 1 0	7E	62
X 1 1 1 1 1 1 1	7F	63

Space commands are used in the following modes:

. 15-line feed mode

A maximum of 15 lines can be fed. WIF6 to WIF8 are ignored.

. 63-line feed mode

A maximum of 63 lines can be fed. WIF7, WIF6, and WIF4 to WIF1 indicate the number of lines fed. WIF8 is ignored.

One of these modes can be selected at the operator panel. For the selection method, refer to Operator's Guide.

When the printer receives a Space command, the printer feeds forms the specified number of lines after printing all characters in the PDB. If the Space command is received before the 132nd (or 136th) character code, the remaining characters are treated as spaces. If the Space command is received without character codes, the printer does not print, it only feeds forms.

WIF5 must be 1 because WIF5 indicates Space commands.

If a Space command attempts to feed forms past the TOF position, the forms feed can be stopped at the TOF position. This feature is called the "step-count truncate". This feature can also be set up at the operator panel. For the setting method, refer to Operator's Guide.

This chapter describes the Centronics-compatible interface used as the I/O interface to the M304x series line printer.

5.1 Operation Outline

Basic printer operations which are data transfer, printing, and forms feed, are shown in Figure 5.1.

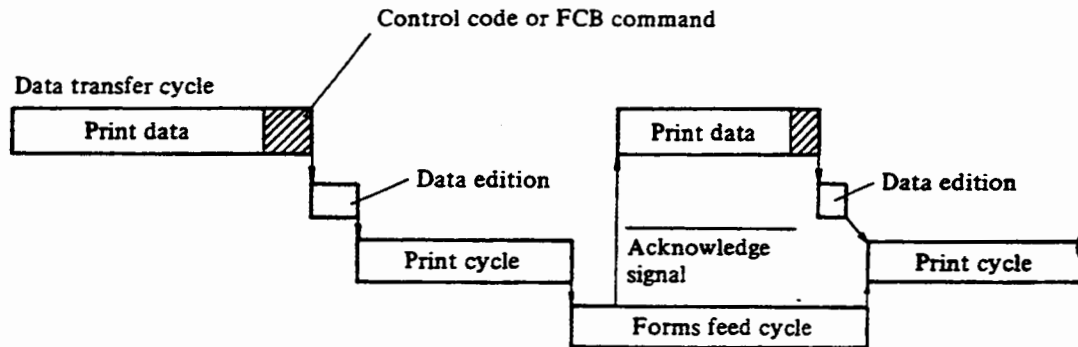

Figure 5.1 Basic operations

The printer goes online when one of the following conditions occurs (see Section 5.2 for interface signals):

- . When the START/STOP switch is pressed:
- . When control code DC1 (X'11') and interface signal Data Strobe are received:

When the printer is online, interface signal Select is set to 1 and the START/STOP lamp is on. The printer sets the Busy signal to 0 and issues the Acknowledge signal. In online mode, the printer receives 1-line print data sent from the host, and starts the print cycle when one of the following conditions occurs:

- . When the control code (CR, LF, FF, VT, or DC3) is received (see Section 5.3.2):
- . When the FCB command is received (see Section 5.5):
- . When the print data buffer (PDB) becomes full:

The character code received first is printed in the first print position, the one received second in the second print position, and so on.

After printing, the printer performs forms feed as specified by the control code or VFU command. When the forms are fed to the line preceding the last line printed, the Acknowledge signal goes to 1 and the Busy signal goes to 0, enabling print data to be received for the next line. Thus, the data is received at the same time as forms feed.

The printer goes offline (the deselect state) when one of the following conditions occurs:

- . When the START/STOP switch is pressed:
- . When the Input Prime signal goes to 1:
- . When the printer receives The DC3 code (X'13'):
- . When the printer is inoperable (Fault state):

The top of form (TOF) and the bottom of form (BOF) referred to in this section are defined as follows:

. TOF

When the forms control buffer (FCB) data has been loaded, the TOF is the line to which channel 1 is first specified in the VFU data.

When the VFU data has not been loaded or when channel 1 is not contained in the VFU data, the TOF is the first line on the page.

. BOF

When the FCB data has been loaded, the BOF is the line to which the BOF channel is first specified in the FCB data. The BOF channel can be specified with any channel number from 2 to 12 from the operator panel. For the channel specification method, refer to Operator's Guide.

When the FCB data has not been loaded or when the BOF channel is not contained in the FCB data, the BOF is the last line on the form (Page). If the skip-over perforation feature, which specifies the number of lines skipped to avoid printing at or near the perforation, is specified, the BOF line is the last line without the skip-over perforation specification. For the method of setting the skip-over perforation feature, refer to Operator's Guide.

5.2 Interface Signals

This section explains the interface signal functions and physical specification.

5.2.1 Interface signal lines

Centronics-compatible interface signals use both the positive and negative logic. For the positive logic, a positive voltage is used as 1 and a negative voltage as 0. For negative logic the opposite is true. Table 5.1 shows Centronics-compatible interface signal lines.

Table 5.1 Centronics-compatible interface signal lines

Signal name	Signal level (+)		Direction System \longleftrightarrow Printer	Contents
	1	0		
Data Bit 1 to Data Bit 8 (DB1-DB8)	5 V	0	\longrightarrow	These signals are data (character code, FCB data, control code) input from the host to the printer. DB8 is used when the 128-character-set print band is used. (For ASCII 7-bit codes, DB8 can be ignored.)
$\overline{\text{Data Strobe}}$	0	5 V	\longrightarrow	This signal is a synchronizing clock for reading DB1-DB8 input to the printer. The data is read at the rising edge of this signal.
$\overline{\text{Input Prime}}$	0	5 V	\longrightarrow	This signal initializes the printer. When it receives this signal, the printer clears the FCB, PDB, and control functions and goes offline. After clear, TOF is the first line and BOF is the last line. When this signal is received during printing or forms feed, the settings are cleared after the operation.
Busy	5 V	0	\longleftarrow	When this signal is 1, the printer is not ready to receive data. This signal is issued in one of the following cases: <ul style="list-style-type: none"> . During printing . During forms feed . During offline state (including the TEST and SET UP modes) . When the printer is inoperable (fault state) . When the printer responds to a control code (except the DC1 code) . When the printer responds to each VFU data byte following to the start code (X'1D')
$\overline{\text{Acknowledge}}$	0	5 V	\longleftarrow	This signal is sent to the mainframe when the printer can receive data. This signal is used to inhibit sending signal by the host until the printer operation such as loading the received code. This signal is sent with a 2.5 to 5.5 μ s width pulse.
$\overline{\text{Fault}}$	0	5 V	\longleftarrow	This signal is issued during an error state or another or inoperable state, such as top cover open or end of forms. (Fault state)

Table 5.1 Centronics-compatible interface signal lines - continued

Signal name	Signal level (+)		Direction System ↔ Printer	Contents
	1	0		
Select			←	This signal is when the printer goes online by pressing of the START/STOP switch without the fault state. This signal is also issued when the DC1 code is received, because the printer goes online. Without this signal, the host cannot transfer data.
Paper Empty	5 V	0	←	This signal is set to 1 when the end of forms is detected. The printer receives and prints all the data to the end (BOF) of the page and then advances the forms to the next TOF position. The printer also sends the Busy and $\overline{\text{Fault}}$ signals and goes offline.
$\overline{\text{Fuse}}$	0	5 V	←	This signal is 1 when the printer power is on.
+5 V	5 V	0	←	This is power for the external tester. The maximum current is 500 mA.
Logic Ground	-	-	←	The maximum current in this logic ground line is 500 mA.
Chassis Ground	-	-	←	Flame ground

Figures 5.2 to 5.7 show character code transfer timing, control code receive timing, DC1 code receive timing, DC3 code receive timing, Skip-15-Lines command receive timing, and FCB data receive timing, respectively.

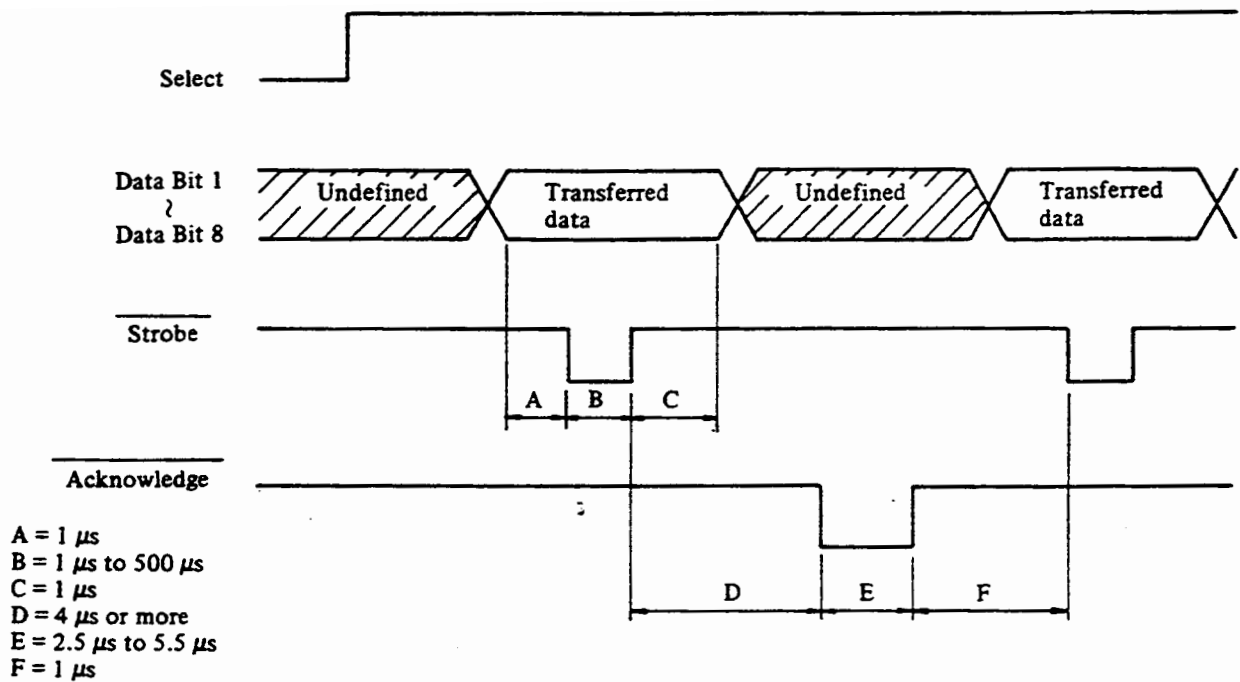
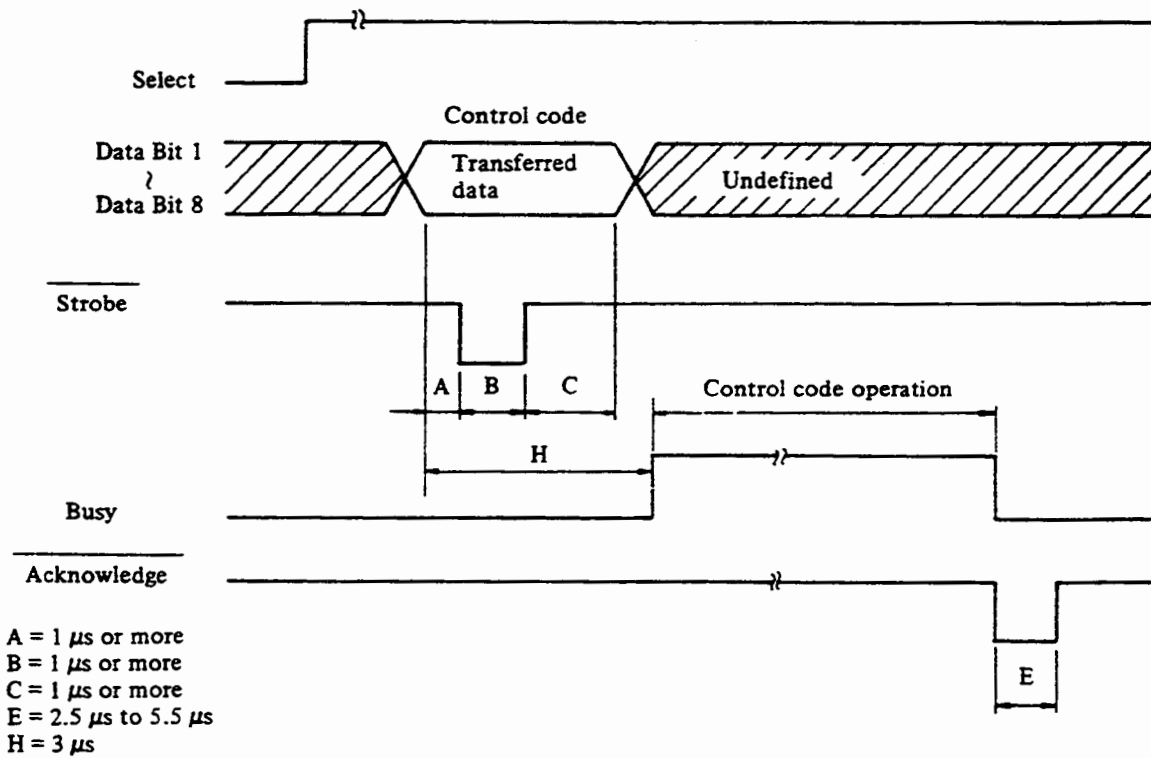
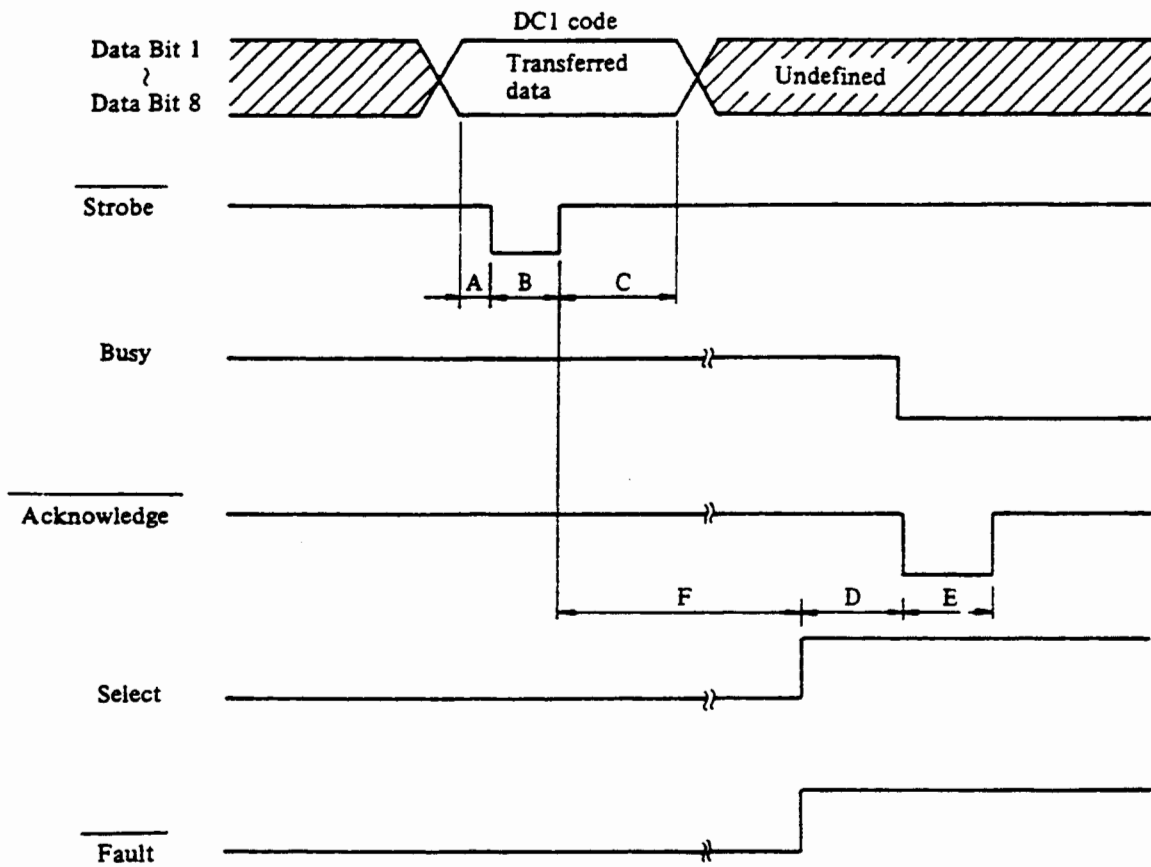

Figure 5.2 Character code transfer timing



+ The control code is the CR, LF, FF, VT, DEL, BEL, or ESC code.

Figure 5.3 Control code receive timing



- A = 1 μ s or more
- B = 1 μ s or more
- C = 1 μ s or more
- D = 10 μ s or more
- E = 2.5 μ s to 5.5 μ s
- F = 40 μ s or more

Note: This is the timing chart for when the DCI code is received while the Select signal is 0. When the DCI code is received while the Select signal is 1, the Select signal is ignored.

Figure 5.4 DCI code receive timing chart

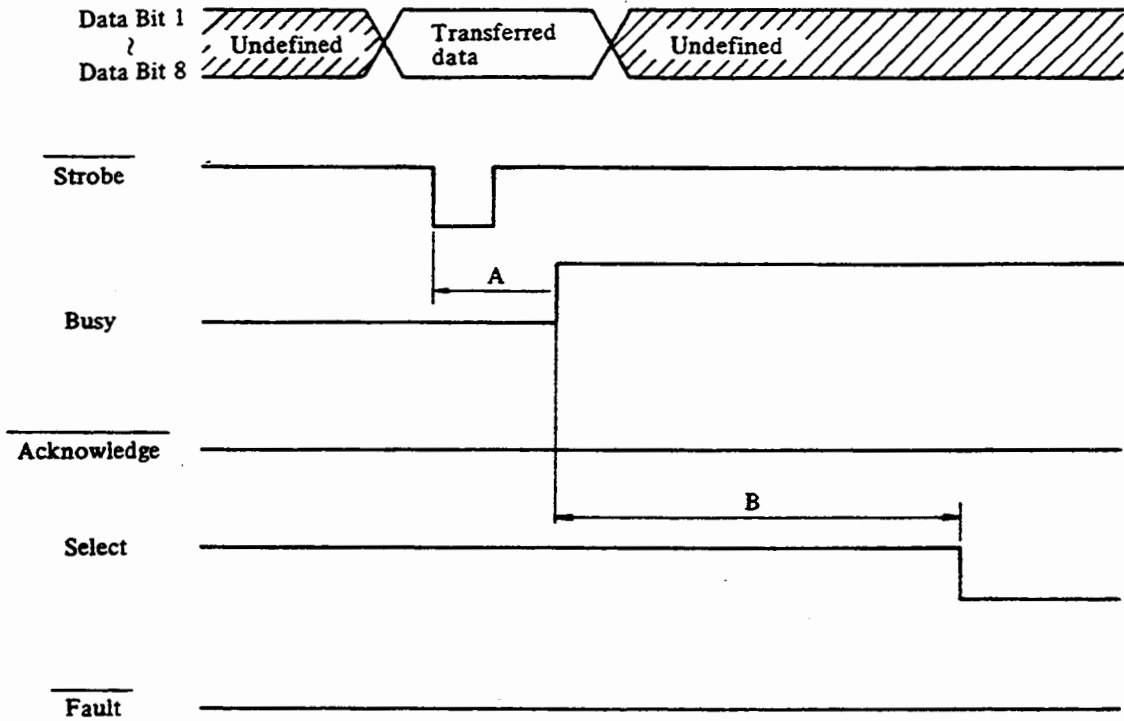

A = 2.5 μ s or more
 B = 100 μ s or less

Note: When receiving the DC3 code, the printer goes offline and does not issue the Acknowledge signal.

Figure 5.5 DC3 code receive timing

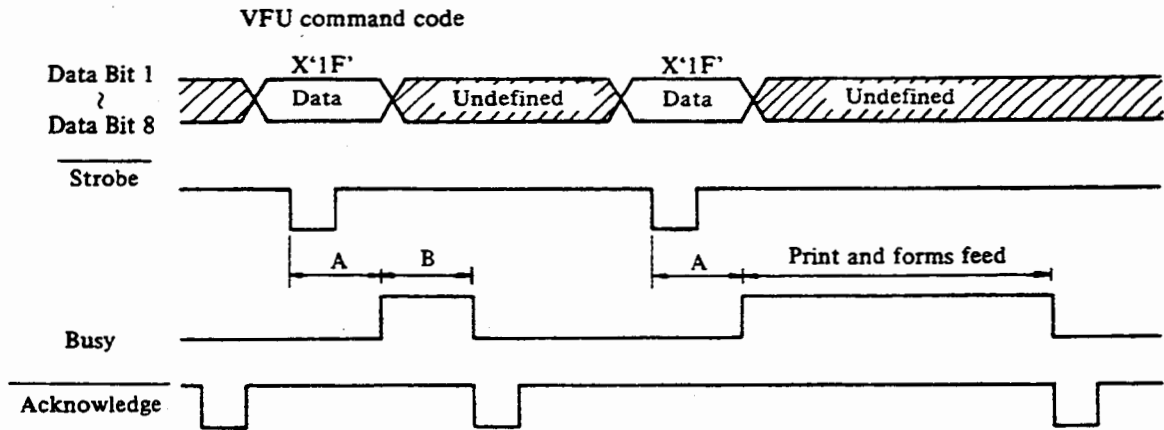

A = 2.5 μ s or more
 B = 100 μ s or more

Note: The Busy signal is set to 1 each time FCB command code X'1F' and data are sent.

Figure 5.6 Skip-15-Lines command receive timing chart

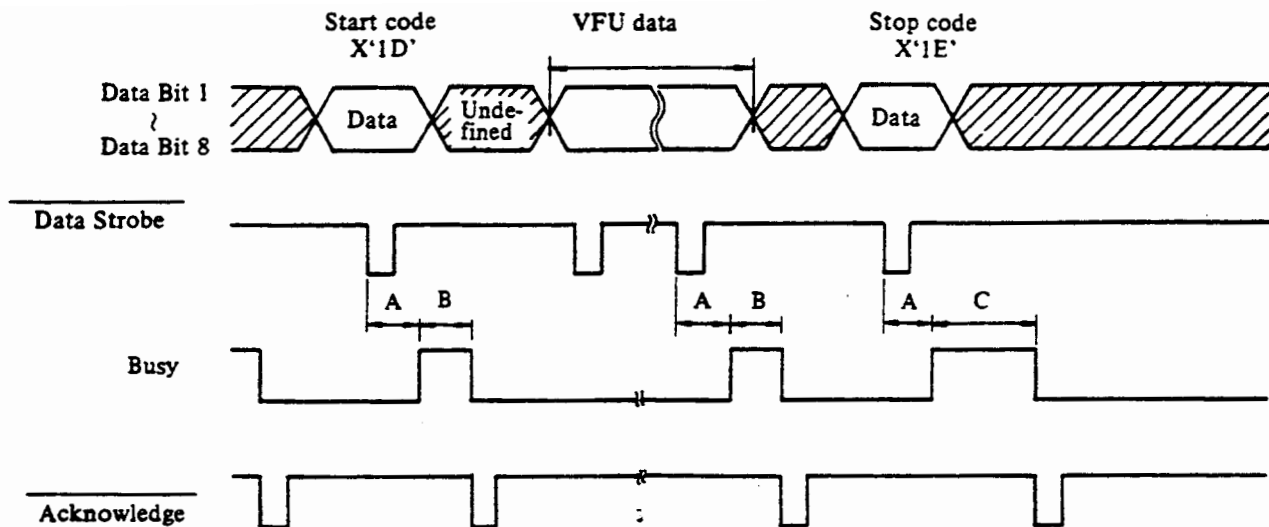

A = 2.5 μ s or more
 B = 100 μ s or more
 C = 300 μ s or more

Note: The Busy signal is set to 1 each time an FCB data byte is received during a sequence between the start and stop codes.

Figure 5.7 FCB data receive timing chart

5.2.2 Physical specifications of interface signals

The physical specifications of Centronics-interface signals consist of electrical specifications, interface cable specifications, and connector pin assignment specifications.

(1) Electrical specifications

Signal levels must be within the following ranges:

Low 0.0 to +0.4 V
 High +2.4 to +5.5 V

Note: The signal level above are at the interface connector.
 Incorrect signals may be issued at power-on and power-off.

The interface signal driver and receiver must be the same as those shown in Figure 5.8.

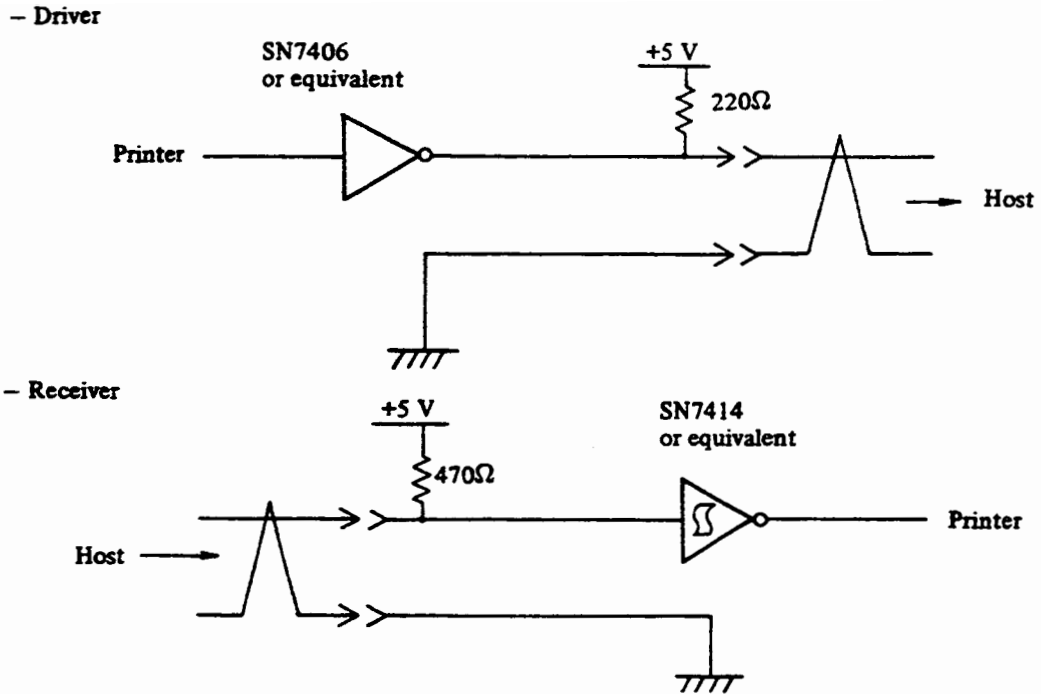

Figure 5.8 Centronics-compatible interface signal driver/receiver

(2) Interface cable

Shielded twisted-pair cables must be used for the interface cable. The cable length must be 25 feet (7.62 m) or less.

(3) Connector and pin assignment

An Amphenol-type can be used as the interface connector to the printer. Figure 5.9 shows connector pin assignment.

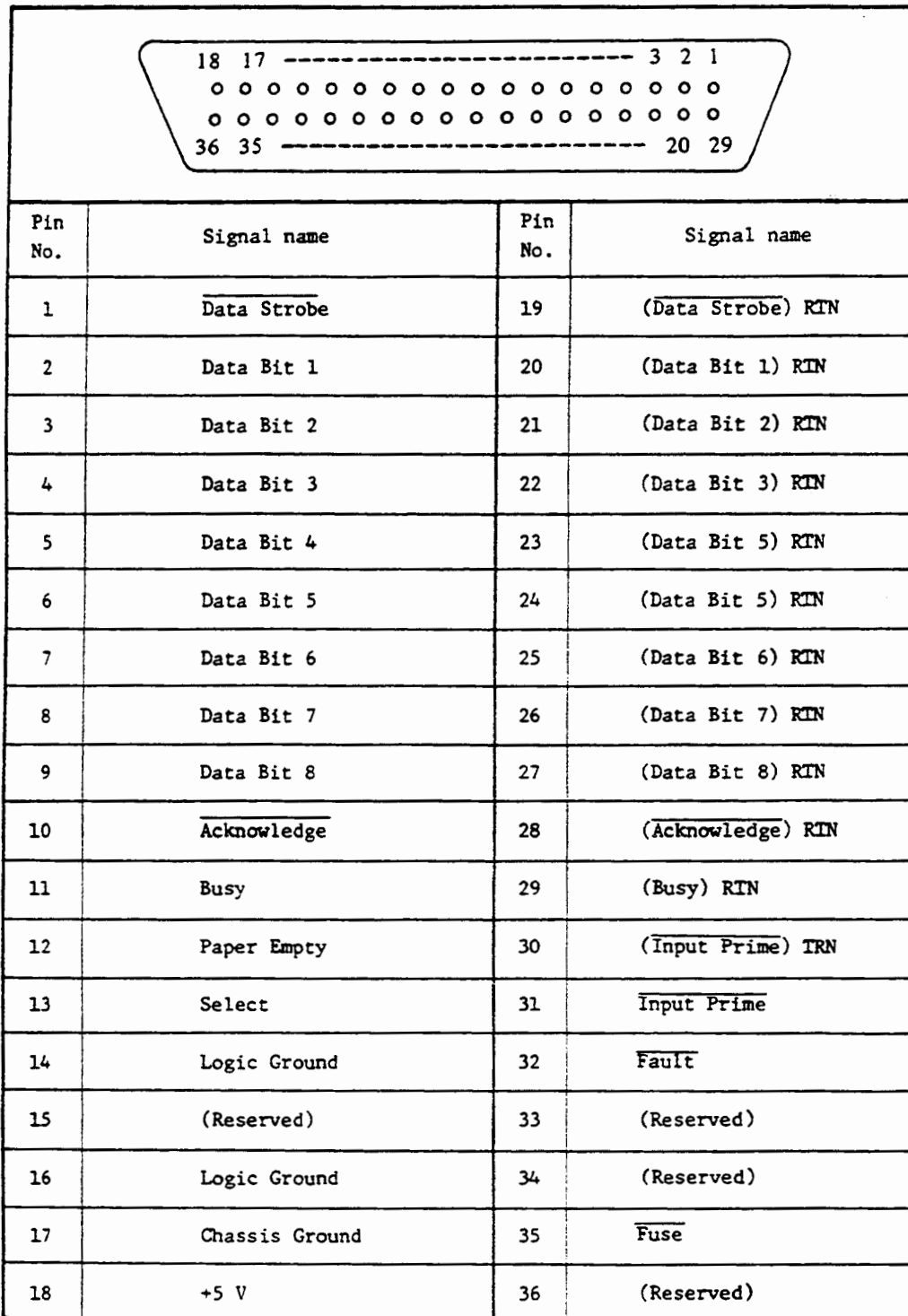

Note: The RTN is ground line for each signal.

- Connector specifications
 - Amphenol 57-40360 or equivalent (printer side)
 - Amphenol 57-30360 or equivalent (cable side)

Figure 5.9 Centronics-compatible interface connector pin assignment

5.3 Character and Control Codes

Table 5.2 shows character and control codes. Table areas enclosed in boldfaced lines contain control codes, other areas contain character codes (ASCII codes). The table shows character codes for 8-bit mode. In 7-bit mode, character codes X'00' to X'7F' can be used. Character codes with an asterisk vary with the print band for each country, as shown in the lower table.

Table 5.2 Character (ASCII) and control codes

☐ : Control code area

B ₈	→					0	0	0	0	0	0	0	0	1	1	1	1	1	1	1	1	
B ₇	→					0	0	0	C	1	1	1	1	0	0	0	0	1	1	1	1	
B ₆	→					0	0	1	1	0	0	1	1	0	0	1	1	0	0	1	1	
B ₅	→					0	1	0	1	0	1	0	1	0	1	0	1	0	1	0	1	
B ₄	B ₃	B ₂	B ₁	L/U		0	1	2	3	4	5	6	7	8	9	A	B	C	D	E	F	
0	0	0	0	0	☐			SP	0	@*	P	*P										
0	0	0	1	1	☐	DC1	!	1	A	Q	a	q										
0	0	1	0	2	☐		"	2	B	R	b	r										
0	0	1	1	3	☐	DC3	#*	3	C	S	c	s										
0	1	0	0	4	☐		\$*	4	D	T	d	t										
0	1	0	1	5	☐		%	5	E	U	e	u										
0	1	1	0	6	☐		&	6	F	V	f	v										
0	1	1	1	7	☐	BEL	'	7	G	W	g	w										
1	0	0	0	8	☐		(8	H	X	h	x										
1	0	0	1	9	☐)	9	I	Y	i	y										
1	0	1	0	A	☐	LF	*	:	J	Z	j	z										
1	0	1	1	B	☐	VI	ESC	+	;	K	[*	k	{*									
1	1	0	0	C	☐	FF	,	<	L	\	*l	!*										
1	1	0	1	D	☐	CR	Start code	-	=	M]*	m]*									
1	1	1	0	E	☐	Stop code	.	>	N	-*	n	-*										
1	1	1	1	F	☐	VFU command	/	?	0	-	o	DEL										

Code	X'23'	X'24'	X'40'	X'5B'	X'5C'	X'5D'	X'5E'	X'60'	X'7B'	X'7C'	X'7D'	X'7E'
Country												
U.S.A.	*	S	@	[\	}	-	-	{		}	-
U.K.	f	S	@	[\	}	-	-	{		}	-
France	f	S	a	o	c	s	-	-	e	u	e	-
Germany	*	S	s	A	o	u	-	-	a	o	u	B
Sweden	*	☉	E	A	o	A	u	e	a	o	a	u
Denmark	*	S	E	A	o	A	u	e	a	o	a	u

Note: Codes with an asterisk in the table above vary with the print band for each country as follows:

5.3.1 Character codes

The ASCII code is used as standard the character code.

If the printer receives a character code not specified in the character code table or not included on the print band, the code is changed to the space code (X'20') or to a character code specified by setting, and no character is printed. If a character code from X'A0' to X'FE' is received in 7-bit mode, the Data Bit 8 signal can be ignored (regarded as 0) by setting, and a character corresponding to each code from X'20' to X'7E' is printed. For the setting method, refer to Operator's Guide.

When receiving character codes, the printer sequentially loads them in its internal buffer (IBF). Characters corresponding to the loaded character codes are printed after a control code is received. The IBF is cleared after printing. The character code received next is for column 1.

5.3.2 Control code

The line feed (LF), vertical tab (VT), form feed (FF), carriage return (CR), FCB command control, escape (ESC), DC1, DC3, start, stop, bell (BEL), and delete (DEL) codes are control codes contained in the area enclosed by boldfaced lines in Table 6.2. The LF, VT, FF, CR, and FCB command control codes are called data transferred termination codes (DTTC).

The printer starts an operation such as printing, forms feed, loading data, or modifying a set mode when the control code is received.

(1) Data transfer termination code (DTTC)

Once it starts receiving data, the printer continues to receive data unless it receives a DTTC, such as the CR code and FCB command control code, or the number of received character codes reaches 132 (136 can be specified) (buffer-full state). When terminating data reception, the printer sets the Busy signal to 1 and prints the received data. Then, the printer advances the form as specified. However, if the LF, VT, or FF code is received before the buffer becomes full or before the CR code is received, the printer can advance the form as specified without printing received data. This is set from the operator panel. The data remaining in the PDB is not printed unless the buffer becomes full or the CR code is received.

a. LF code (X'0A')

When it receives the LF code, the printer advances one line.

b. VT code (X'0B')

When it receives the VT code, the printer advances forms to the next vertical tab channel position, which is set from the operator panel, except the TOF and BOF channels. The VT code can be set as the LF code from the operator panel.

c. FF code (X'0C')

When receiving the FF code, the printer advances the form to the channel-1 position (TOF) specified by data in the FCB or format control tape (FCT). When channel 1 is not specified, the printer treats the first line on a page as the TOF and advances the form to that position.

d. CR code (X'0D')

The CR code indicates the end of a line. When it receives the CR code, the printer prints characters corresponding to the received character codes starting from column 1. Either one-line forms feed mode (this is the same as the mode selected by the LF code) or forms-feed inhibited mode can be selected for after printing.

e. FCB command control code (X'1F')

When it receives two bytes of the FCB command control code and the subsequent FCB command, the printer terminates the data transfer cycle and prints the contents of the PDB, then advances the form as specified. For details on the FCB commands, see Section 5.5.

(2) ESC code (X'1B')

The ESC code is used to switch the line spacing (6 LPI or 8 LPI) from the host. The host issues the ESC code before loading the FCB data. The ESC code is required only if the line spacing must be switched.

The line spacing is specified in one byte after the ESC code, as follows:

ESC (X'1B') + 6 (X'36') Set to 6 LPI.

ESC (X'1B') + 8 (X'38') Set to 8 LPI.

ESC (X'1B') + 0 (X'30') Reset to the line spacing specified on the operator panel.

The ESC code function can be disabled by setting on the operator panel.

(3) Start code (X'1D') and stop code (X'1E')

The start and stop codes are used to load the forms feed format in the FCB. Within 300 μ s after it receives the start code, the printer sets the Busy signal to 0, enabling FCB data to be received. For details on FCB data reception, see Section 5.4.1.

(4) DC1 code (X'11') and DC3 code (X'13')

When it receives the DC1 code, the printer goes online and can receive data from the host. The DC1 code is the only code receivable when the printer is in the busy state (Busy signal = 1). In online mode, the printer sets the Select signal to 1 and turns on the START/STOP lamp on the operator panel.

When it receives the DC3 code, the printer goes offline (deselect state). In offline mode, the printer sets the Select signal to 0 and turns off the START/STOP lamp.

(5) DEL code (X'7F')

When it receives the DEL code, the printer clears the PDB and loads the next data in the PDB, as the first data of the next line. The DEL code can be inhibited by setting from the operator panel.

(6) BEL code (X'07') (option)

When the printer receives the BEL code, the printer buzzer sounds for 1 second. The printer is in the busy state during the buzzer sound.

5.4 Format Control

In addition to using the control codes, the printer can use the format control feature, which specifies a form (page) length and print format for a page.

The feature is implemented by the following:

- . Loading data from the host to the FCB
- . Loading data from the FCT
- . Form length specification on the operator panel

The printer has the FCB and the form length specification feature. An FCT unit can be incorporated as an option.

When an FCT is not used, format control data is transferred from the host to the printer online and loaded in its FCB. When the FCT is used, the format control data is transferred from the FCT unit to the printer offline mode and is loaded in its FCB.

The format control data indicates channel numbers, which are used by software to indicate a special line on a page.

The format specification from the operator panel is not selected when the format has been specified from the host or FCT in the FCB. However, specification from the operator panel can be used in TEST mode.

5.4.1 Loading from the mainframe to the FCB

The forms feed information must be loaded in the FCB before forms feed, except when an LF, FF, or CR control code is specified.

The data loaded in the FCB is used for forms feed control by the VT or FF code or the FCB command transferred just after the print data.

Following to the start code (X'1D'), the forms feed data is sent in 2-byte units for every line and is terminated by the stop code (X'1E'). Figure 6.10 shows an example of loading the data in the FCB.

The channel data for the first line consists of 2 bytes just after the start code. Data for the second line is the next 2 bytes. Data for a maximum of 176 lines can be loaded in the FCB (356 bytes). The TOF (channel 1) is set just after the start code and also 2 bytes just before the stop code. If the number of bytes loaded is odd or exceeds 356 bytes, the Fault signal is set to 1 and the STATUS indicator shows the error contents.

If the TOF code is issued in the middle of the FCB data stream, the TOF code is ignored until the stop code is issued.

Data byte No.	Data Bit signal							Hex. data		
	8	7	6	5	4	3	2			1
-	0	0	0	1	1	1	0	1	1D	Start code
1	X	1	0	0	0	0	0	1	41	Line 1 Channel 1 (TOF)
2	X	1	0	0	0	0	0	0	40	
3	X	1	0	0	0	0	0	0	40	Line 2
3	X	1	0	0	0	0	0	0	40	
9	X	1	0	0	0	0	0	0	40	Line 5
10	X	1	0	0	0	0	0	0	40	
11	X	1	0	0	0	0	1	0	42	Line 6 Vertical Tab Channel 2
12	X	1	0	0	0	0	0	0	40	
19	X	1	0	0	0	0	0	0	40	Line 10
20	X	1	0	0	0	0	0	0	40	
21	X	1	0	0	0	1	0	0	44	Line 11 Vertical Tab Channel 4
22	X	1	0	0	0	0	0	0	40	
109	X	1	0	0	0	0	0	0	40	Line 55
110	X	1	0	0	0	0	0	0	40	
111	X	1	0	0	0	0	0	0	40	Line 56
112	X	1	1	0	0	0	0	0	60	
119	X	1	0	0	0	0	0	0	40	Line 60
120	X	1	0	0	0	0	0	0	40	
121	X	1	0	0	0	0	0	0	43	Line 61 Channels 12 (BOF)
122	X	1	1	0	0	0	0	0	40	
123	X	1	0	0	0	0	0	0	40	Line 62
124	X	1	0	0	0	0	0	0	40	
125	X	1	0	0	0	0	0	0	40	Line 63
126	X	1	0	0	0	0	0	0	40	
127	X	1	0	0	0	0	0	0	40	Line 64
128	X	1	0	0	0	0	0	0	40	
129	X	1	0	0	0	0	0	0	40	Line 65
130	X	1	0	0	0	0	0	0	40	
131	X	1	0	0	0	0	0	0	40	Line 66
132	X	1	0	0	0	0	0	0	40	
133	X	1	0	0	0	0	0	1	41	Line 67 Channel 1 (TOF)
134	X	1	0	0	0	0	0	0	40	
-	0	0	0	1	1	1	1	0	1E	Stop code

X is ignored.

Figure 5.10 Loading the data in the FCB

5.4.2 Loading from an FCT to the FCB

The FCT is a looped paper tape with punched holes and sprocket holes for feeding. There are 2 types of FCT; 8-channel and 12-channel. The punched hole data is read by the FCT unit and loaded in the FCB.

The FCT is read automatically when the printer is turned on or when the RUN switch on the FCT unit is pressed in offline mode. The RUN switch enables a new FCT to be read. Because the FCT unit determines that channel 1 of the FCT is the start position, the FCT unit reads punched hole data starting from channel 1 to the next channel 1 detected and sends the read data as a forms feed format.

See Section 4.4.2 for the method for making an FCT.

5.4.3 Format specification from the operator panel

The number of lines per page is used to specify the page length from the operator panel. Thus, a page length specified with 6 LPI differs from that specified with 8 LPI, even if the form is the same length.

The number of lines skipped to avoid printing on or too near a perforation can be specified from the operator panel. (Skip-over perforation feature) For the setting method, refer to Operator's Guide.

5.5 FCB Commands

A FCB command is sent from the host via the I/O interface, to control forms feed. Following the FCB control code (X'1F'), a 1-byte FCB command is issued.

The n-Line Skip commands and Skip to Channel-n commands are FCB commands.

5.5.1 n-Line Skip commands

When one of the data items shown in Table 5.3 follows the FCB command control code sent after print data, the printer determines the data to be the n-Line Skip command. The printer prints all the data in the PDB and advances the form by the number of lines specified in the command.

Table 5.3 n-Line Skip commands

Data Bit signal 8 7 6 5 4 3 2 1	Hex	Number of lines fed
x x x 1 0 0 0 0	10	0
x x x 1 0 0 0 1	11	1
x x x 1 0 0 1 0	12	2
x x x 1 0 0 1 1	13	3
x x x 1 0 1 0 0	14	4
x x x 1 0 1 0 1	15	5
x x x 1 0 1 1 0	16	6
x x x 1 0 1 1 1	17	7
x x x 1 1 0 0 0	18	8
x x x 1 1 0 0 1	19	9
x x x 1 1 0 1 0	1A	10
x x x 1 1 0 1 1	1B	11
x x x 1 1 1 0 0	1C	12
x x x 1 1 1 0 1	1D	13
x x x 1 1 1 1 0	1E	14
x x x 1 1 1 1 1	1F	15

x is ignored.

5.5.2 Skip to Channel-n commands

When one of the data items shown in Table 5.4 follows the FCB command control code issued after print data, the printer determines that the data is the Skip to Channel-n command. The printer prints all the data in the PDB and advances the form to the line corresponding to the specified channel position in the FCB data.

Table 5.4 shows the relationships between the Skip to channel-n command data and channel numbers.

Table 5.4 Skip to Channel-n commands

Data Bit signal 8 7 6 5 4 3 2 1	Hex	Number of lines fed
x x x 0 0 0 0 1	01	Channel 1
x x x 0 0 0 1 0	02	Channel 2
x x x 0 0 0 1 1	03	Channel 3
x x x 0 0 1 0 0	04	Channel 4
x x x 0 0 1 0 1	05	Channel 5
x x x 0 0 1 1 0	06	Channel 6
x x x 0 0 1 1 1	07	Channel 7
x x x 0 1 0 0 0	08	Channel 8
x x x 0 1 0 0 1	09	Channel 9
x x x 0 1 0 1 0	0A	Channel 10
x x x 0 1 0 1 1	0B	Channel 11
x x x 0 1 1 0 0	0C	Channel 12
x x x 0 1 1 0 1	0D	Undefined An error occurs.
x x x 0 1 1 1 1	0F	

If an undefined command or a channel No. no loaded in the FCB is specified, the printer enters the fault state and displays error information on its STATUS indicator.

This chapter describes the RS-232-C interface used for the I/O interface connected to the M304x series line printer (printer). The printer conforms with the EIA RS-232-C interface logical level and has various functions.

6.1 Operation Outline

The basic printer functions are as follows:

- Feeds forms according to Line Feed (LF), Carriage Return (CR), Forms Feed (FF), and Vertical Tab (VT) codes.
- Downloads the forms control buffer (FCB) data from the host sent with the Load FCB Data command.
- Feeds forms as specified by the Space n Line command or the Skip to Channel n command.

The printer receives serial data transmitted from the host, assembles it in to 7-bit or 8-bit data, checks for even, odd, or no parity, and writes the data in the 2K-byte interface buffer. The interface buffer state is transmitted to the host by using the Reverse Channel signal (SCA or SRS) or the XON/XOFF code.

Asynchronous data consists of a start bit, 7 or 8 data bits, a parity bit (unless no parity), and 1, 1.5, or 2 stop bits (Teletype procedure). A band of 2.4, 4.8, 9.6 or 19.2 K can be set for the printer.

Figure 6.1 shows the basic configuration of the RS-232-C interface circuit.

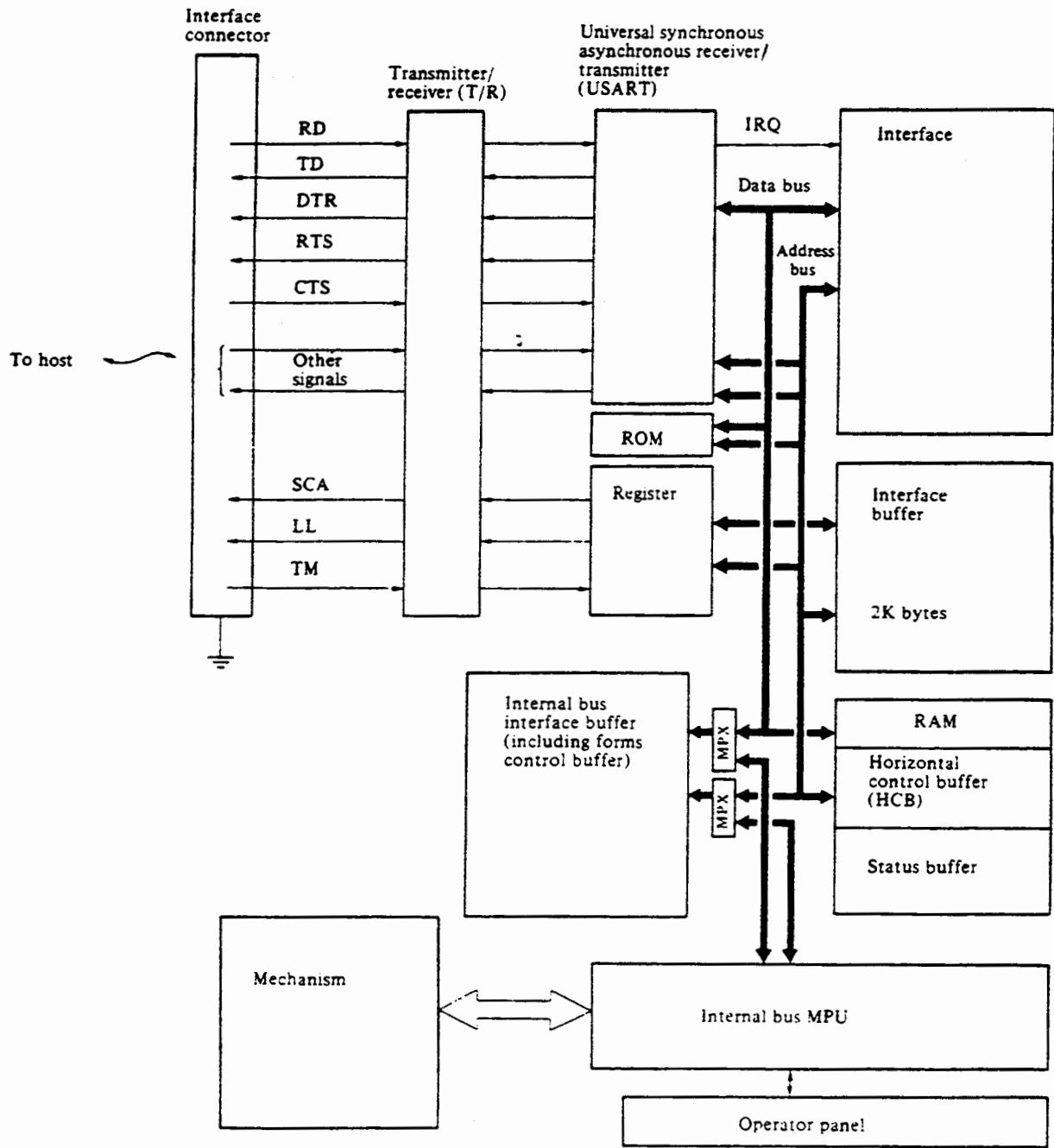

Figure 6.1 RS-232-C interface circuit

Transmitted Data (TD) and Received Data (RD) lines are connected to the universal synchronous asynchronous receiver/transmitter (USART) through a transmitter/receiver (T/R). The Data Terminal Ready (DTR), Request to Send (RTS), and Clear to Send (CTS) control lines are provided for these data lines and are also connected to USART through the T/R.

The USART transmit/receive request line (IRQ) is connected to the interface microprocessor (MPU) via 8-bit bus lines and address lines. The bus and address lines are also connected to the interface buffer and internal bus MPU.

The interface MPU operation is controlled by microprograms stored in the ROM. Microprogram execution is described below.

- Receiving data

When one-word data is generated in the USART from the serially sent data, the USART issues a receive request interrupt to the interface MPU. The interface MPU reads the data, decodes it, and checks whether it is a Status Request command. If not, the interface MPU stacks the data in the interface buffer. If so, it responds with the printer status.

- Transmitting data

When data transmission is necessary (for the printer status response, XON/XOFF transmission, or local loopback test), the interface MPU USART data and writes data in the USART every time the USART issues a transmit request interrupt.

- Commands to the internal bus MPU

When writing data into the interface buffer begins, the interface MPU detects a control code or control sequence written in the interface buffer and decodes it, then issues a command to the internal bus MPU.

Whether the command sent from the internal bus MPU terminates or not, if a mechanical error or operator intervention request (indicated by the Intervention Required signal) occurs, it is reported to the interface MPU. If the command terminates normally, the interface MPU issues the next command.

If printer operation is stopped due to a mechanical error or an operator intervention request (the internal bus MPU cannot operate in this state), the interface MPU stops issuing the next command to the internal MPU and stops reading data in the interface buffer until the mechanical error is corrected or the operator intervention request ends.

The amount of data transmitted from the host can be reduced by the Repeat Character command or the Move Horizontal Position command or by the Horizontal Tabulation (HT) code using horizontal tab stop data downloaded by the Load Horizontal Tab Stop Data command.

A line feed pitch of 6/8 lpi can be selected by the Select Vertical Pitch command. A half-line feed pitch of 12 lpi can also be selected by using the Half Line Feed command.

Responding to the Status Request command from the host, the printer reports its status (startus response).

6.2 Interface Signals

This section explains the interface signal functions and physical specifications.

6.2.1 Interface signal lines

The RS-232-C interface uses negative logic when the positive voltage is logical 0 and the negative voltage is logical 1. Table 6.1 lists the RS-232-C interface signal lines and their functions.

Table 6.1 RS-232-C interface signal lines

Signal name	Signal level		Direction System \longleftrightarrow Printer	Functions
	1	0		
Received Data (RD)	-3 V	3 V	\longrightarrow	This signal line receives serial data from the host. This signal line must be 1 (marking) when the Received Line Signal Detector line is logical 1.
Transmitted Data (TD)	-3 V	3 V	\longleftarrow	This signal line transmits codes XON and XOFF, and reports printer status to the host. This signal line is 1 (marking) when the Request to Send signal or Clear to Send signal is 1.
Request to Send (RTS)	-3 V	3 V	\longleftarrow	When this signal is 0, the printer is requesting the host to send data or is transmitting data to the host. After this signal is turned on (0) and the Clear to Send signal goes on (0), the printer begins transmitting data. For operation details, see Table 7.2. Note: When the RTS line protocol is used, this signal does not operate as described above. For details, see Section 4.4.
Clear to Send (CTS)	-3 V	3 V	\longrightarrow	This signal is turned on when the host confirms that the RTS is 0 and data from the printer can be received. For operation details, see Table 7.2.

Table 6.1 RS-232-C interface signal lines - Continued

Signal name	Signal level		Direction System ← Printer	Functions
	1	0		
Data Set Ready (DSR)	-3 V	3 V	————→	<p>When this signal is 0, the host is ready to transmit data (data mode). When this signal is 1, the printer ignores data on the Receive Data (RD) line.</p> <p>Data on the RD line can be validated regardless of this signal state.</p> <p>This signal is 0 when the host is in data mode. It is 1 when the host is in test mode (e.g., during local loopback test).</p>
Data Terminal Ready (DTR)	-3 V	3 V	————→	<p>One of the following modes is selected the operator panel. This signal operates as follows:</p> <ol style="list-style-type: none"> 1. DTR Constant On mode If power is turned on and no error occurs in the printer, the printer sets this signal to 0 and is ready to start (ready to print the data received from the host). After the printer starts, this signal is not set to 1. If power is turned on and an error occurs in the printer, this signal is not set to 0 and the printer is not ready to start. If this state occurs, this signal can be set to 0 and the printer can be ready to start by correcting the cause of the error and pressing the START/STOP switch. 2. Drop DTR Start/Stop mode This signal is set to 0 with the following timing: <ul style="list-style-type: none"> - No error occurred, and - The START/STOP switch was pressed. This signal is set to 1 with the following timing: <ul style="list-style-type: none"> - An error occurred in the printer, or - The START/STOP switch was pressed. <p>Notes:</p> <ol style="list-style-type: none"> 1) Printer start state means that the printer is printing data received from the host or is ready to print (it is not actually printing if the interface buffer is empty.) 2) When the DTR protocol is used, this signal does not operate as described above. For details, see Section 6.4.3.

Table 6.1 RS-232-C interface signal lines - Continued

Signal name	Signal level		Direction System ← Printer	Functions
	1	0		
Reverse Channel (SCA/SRS)	-3 V	3 V	←	<p>If the Reverse Channel line protocol is not selected by setting at the operator panel, this signal stays at 1. If selected, the signal state is as follows:</p> <p>This signal is set to 0 when DTR is 0 or the interface buffer is empty or almost empty (threshold is set at the operator panel). This signal is set to 1 when the interface buffer is almost full (threshold is set at the operator panel) or before DTR is set to 1. The time from when this signal is set to 1 to when it is set to 0 is more than 200 ms. The active polarity of this signal can be set.</p>
Signal Ground (SG)	-	-	—	This line is a signal ground line between the host and printer.
Frame Ground (FG)	-	-	—	This line is a frame ground line between the host and printer.
Ring Indicator (RI)	-3 V (3V)	3 V (-3V)	→	<p>If this signal is set to be effective, the DTR is set to 0 when this signal is 0. This signal is set to 0 for 0.5 to 0.7 sec, and after the DTR and DSR are set to 0 successively, this signal is kept at 1. If the DSR is not used, this signal is kept at 1 after the DTR is set to 0. If an error or operator intervention request does not occur in the printer, the printer turns on.</p>
Received Line Signal Detector (RLSD)	-3 V	3 V	→	<p>When transmitting data to the printer, the host sets this signal on (0). The host keeps this signal at 0 during data transmission. If this signal is 1, the printer ignores data on the RD line. Data on the RD line can be validated by setting, whether this signal is 0 or 1.</p>
Local Loopback (LL)	-3 V	3 V	←	<p>This signal is set to 0 when the local loopback test is performed. The printer performs this test when the host responds by setting this signal on (0). The printer always keeps this signal at 0 during this test.</p>

Table 6.1 RS-232-C interface signal lines - Continued

Signal name	Signal level		Direction System ← Printer	Functions
	1	0		
Test Mode (TM)	-3 V	3 V	————→	<p>If the host detects that the LL signal is on and the local loopback test is executable, it sets this signal on (0).</p> <p>If the host turns this signal on in response to the LL signal being on, the host does not set this signal off (1) until the LL signal is set to 1. If this signal is not set to 0 within 2 sec after the printer sets the LL on (0), the printer terminates the local loopback test and sets the LL off (1).</p>

The combinations of the RTS and CTS signals listed in Table 6.2 are provided for the printer. For the RTS and CTS setup, refer to Operator's Guide.

Table 6.2 Operation by the RTS and CTS combination

RTC setup	CTS setup	Function
Half-duplex mode (HLFDPX)	ENABLE	The printer sets the RTS on (0), waits for the CTS to be set to 0, and transmits data to the host when the CTS is set to 0. When the transmission ends, the printer sets the RTS off (1).
	DISABL	The printer sets the RTS on (0) and transmits data to the host whether the CTS is 0 or 1. When transmission ends, the printer sets the RTs off (1).
Full-duplex mode (FULDPX)	ENABLE	The printer keeps the RTS at 0, and when the CTS is set to 0, the printer transmits data.
	DISABLE	The printer always keeps the RTS at 0 and transmits data whether the CTS is 0 or 1.

6.2.2 Physical specifications of interface signals

The physical specifications of RS-232-C interface signals consist of electrical specifications, interface cable specifications, and connector pin assignment specifications.

(1) Electrical specifications

Signal levels must be within the following ranges:

Low level (off) -3 V or less
High level (on) +3 V or more

Note: These signal levels are measured at the interface connector.
Signals with incorrect levels may be sent at power on and power off.

The interface signal transmitter and receiver must be the same as those shown in Figure 6.2.

• Transmitter

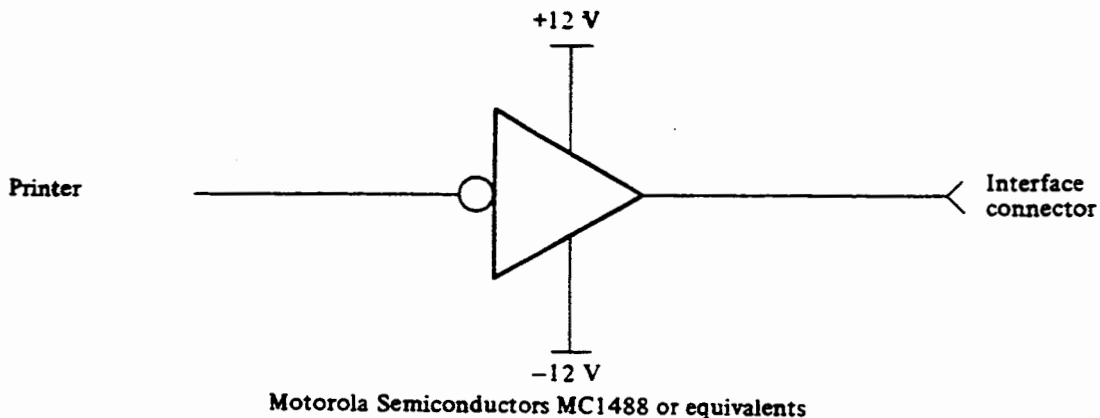

• Receiver

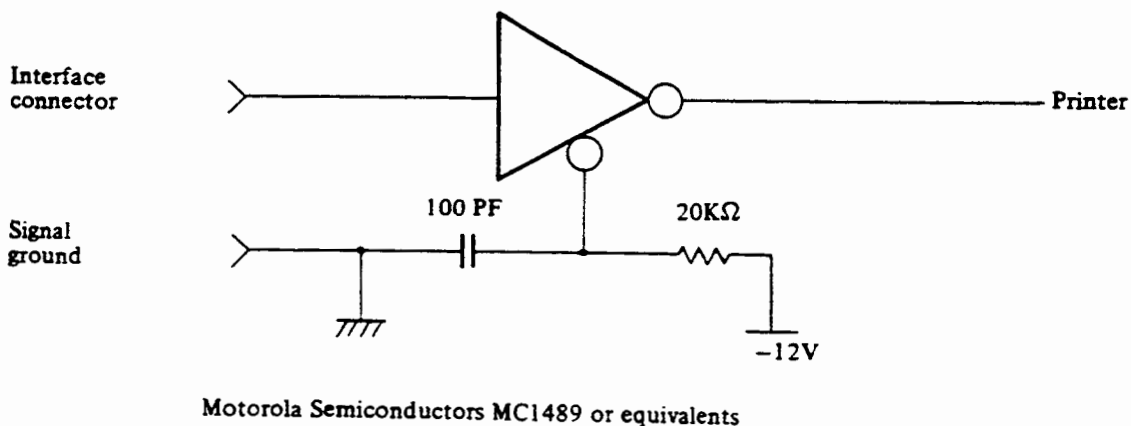
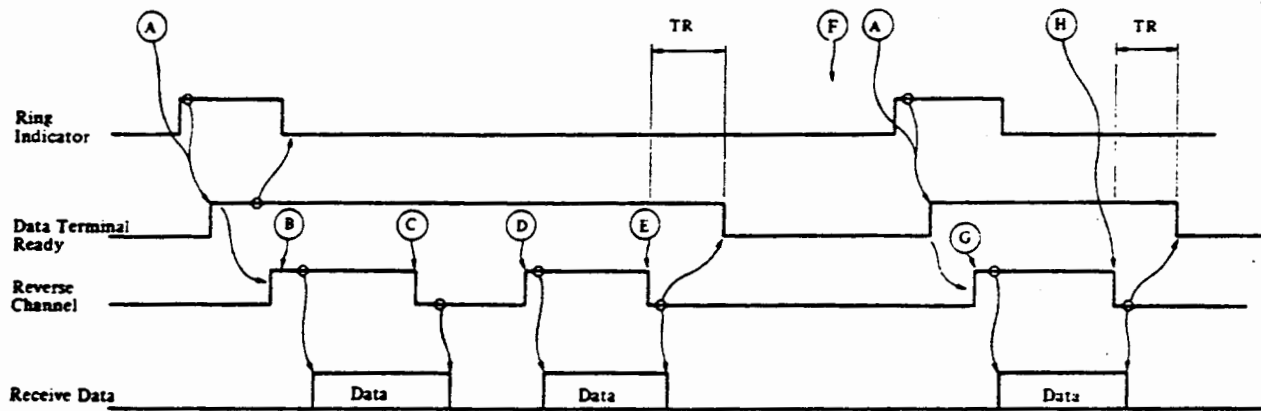

Figure 6.2 RS-232-C interface signal transmitter and receiver

The RS-232-C interface signals operate according to the printer status. Table 6.3 lists the printer statuses. Figures 6.3 to 6.8 show the timing charts for this interface. Interface operation varies depending on the message protocols prepared for the printer. For message protocol details, see Section 6.4.

Table 6.3 Printer statuses

Item	Status	Status indicator
Ⓐ	RI signal is 1 or START/STOP switch is pressed	START
Ⓑ	Interface buffer empty	START
Ⓒ	Interface buffer almost full	START
Ⓓ	Interface buffer almost empty	START
Ⓔ	An error occurred.	Error content display
Ⓕ	Error reset	STOP
Ⓖ	Interface buffer almost empty	START
Ⓗ	START/STOP switch is pressed.	STOP
Ⓘ	Power-on diagnosis end	START
Ⓙ	Power-on diagnosis end	STOP
Ⓚ	START/STOP switch is pressed and interface buffer is almost empty or is empty	START



Note: For (A) to (H), see Table 6.3.

Figure 6.3 Reverse Channel line-protocol (Drop DTR in START/STOP mode)

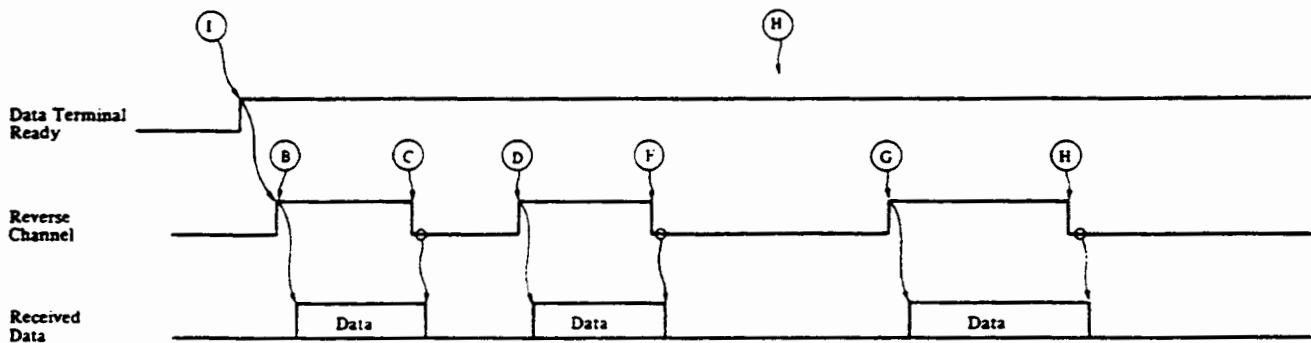

Note: For (B) to (D) and (F) to (I), see Table 6.3.

Figure 6.4 Reverse Channel line-protocol (DTR Constant On mode)

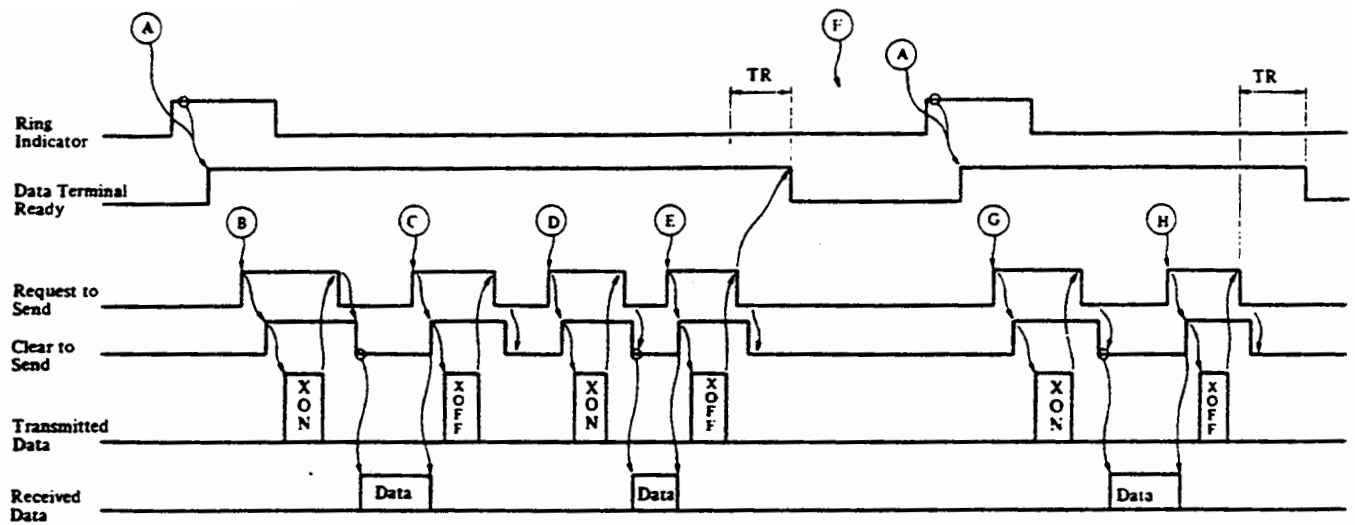

Note: For (A) to (H), see Table 6.3.

Figure 6.5 XON/XOFF protocol
(Drop DTR in START/STOP mode and Half-duplex mode)

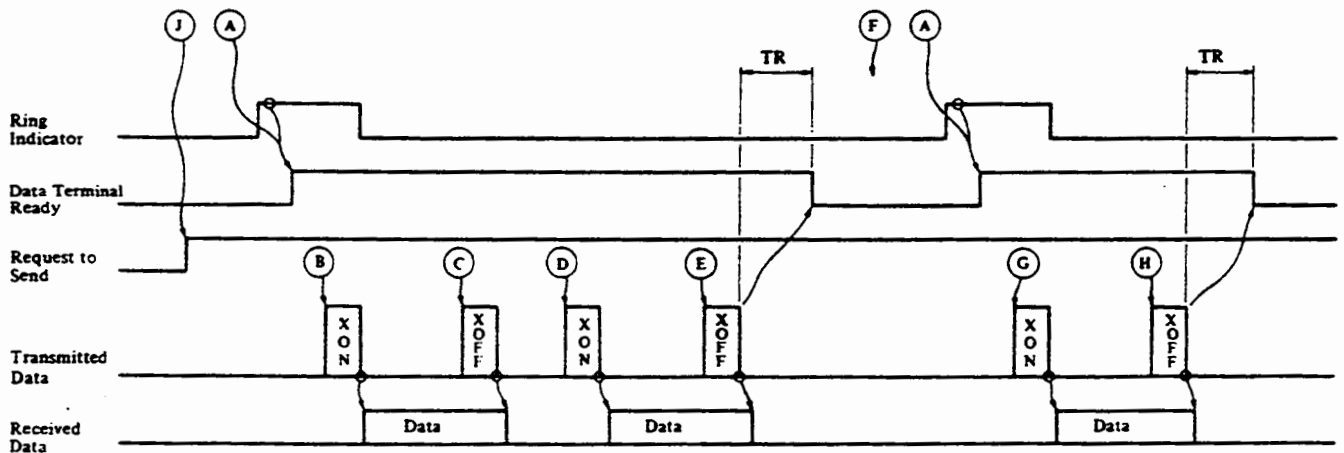

Note: For (A) to (H) and (J), see Table 6.3.

Figure 6.6 XON/XOFF protocol
(Drop DTR in START/STOP mode and Full-duplex mode)

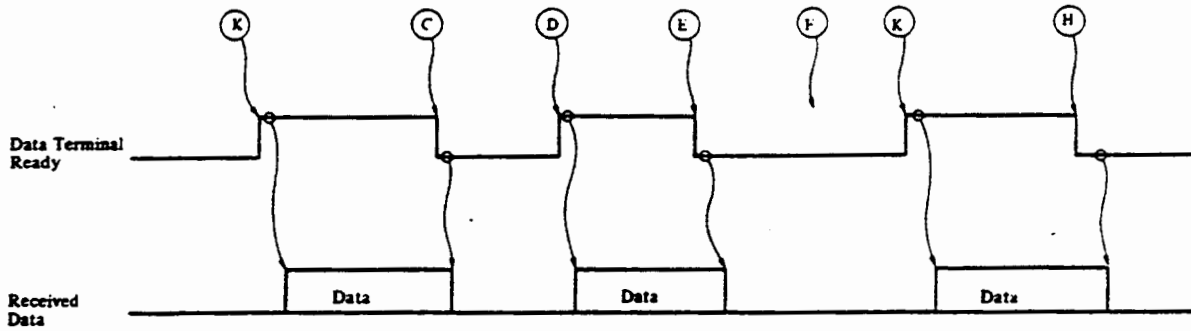

Note: For Ⓒ to Ⓕ, Ⓗ, and Ⓐ, see Table 6.3.

Figure 6.7 DTR line protocol

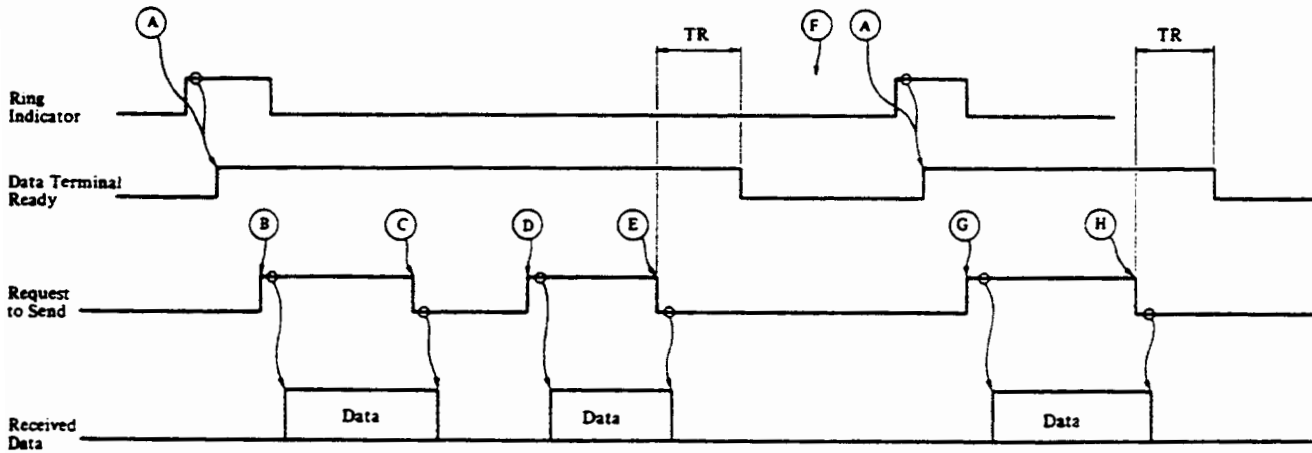

Note: For Ⓐ to Ⓗ, see Table 6.3.

Figure 6.8 RTS line protocol (Drop DTR in START/STOP mode)

(2) Interface cable

A pair of shielded cables must be used as the interface cable. The cable length must be 25 feet (7.5 m) or less.

(3) Connector and pin assignment

A 25-pin standard interface connector (female type) is used. The connector cover is made of metal and is connected to the FG of the cabinet. The interface connector cover is completely shielded.

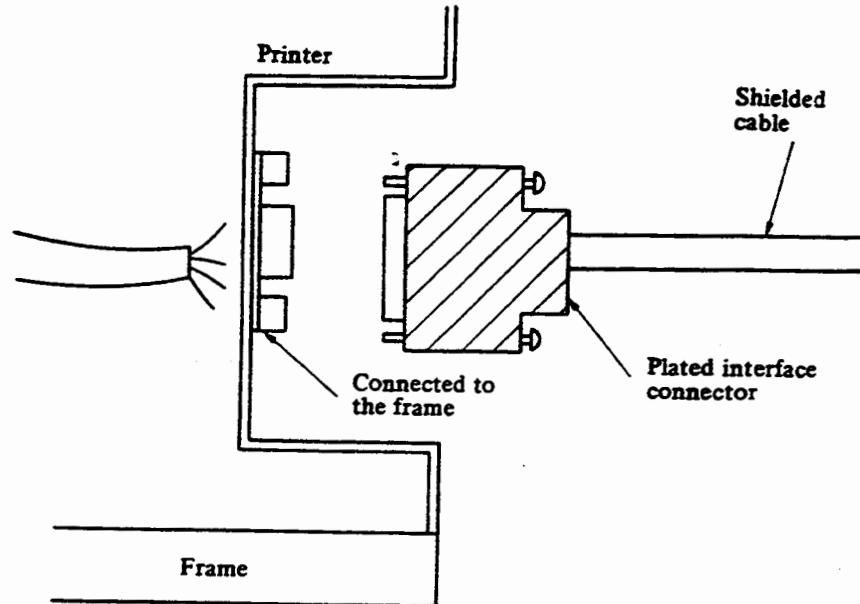

Figure 6.9 Interface cable connector

Figure 6.10 shows the correspondence between RS-232-C interface connector pins and signals.

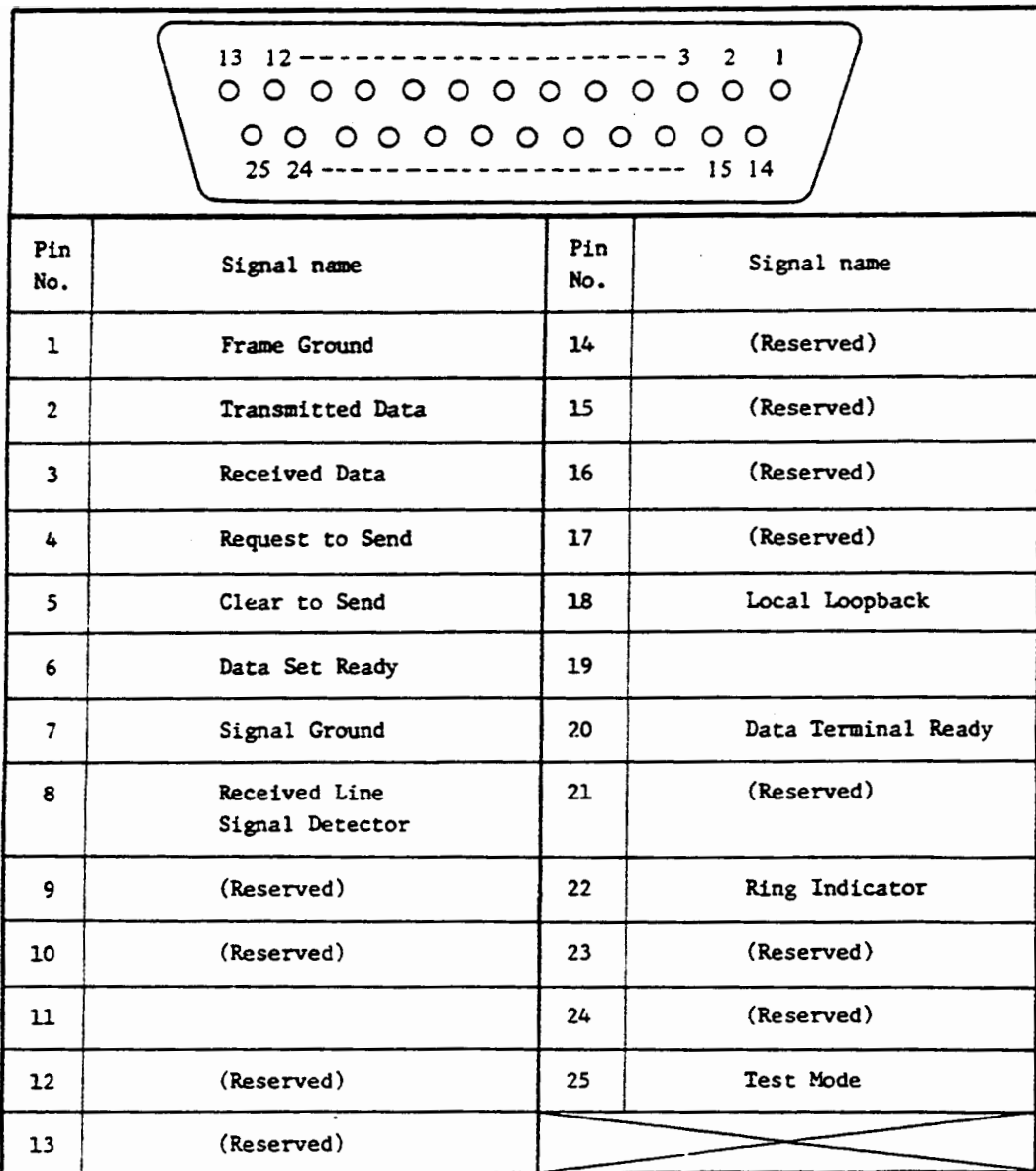

Figure 6.10 RS-232-C interface connector pin assignment

6.3 Character and Control Codes

Table 6.4 shows character and control codes. In the table, areas enclosed with a bold-faced line indicate control codes, whereas the other areas indicate character codes (ASCII codes). The table shows character codes of 8-bit mode. In 7-bit mode, character codes X'00' to X'7F' are available. Character codes with an asterisk in the table vary depending on the print band for each country, as shown in the lower table.

Table 6.4 Character (ASCII) and control codes

☐ : Control code area

B ₈					0	0	0	0	0	0	0	0	1	1	1	1	1	1	1	1		
B ₇					0	0	0	0	1	1	1	1	0	0	0	0	1	1	1	1		
B ₆					0	0	1	1	0	0	1	1	0	0	1	1	0	0	1	1		
B ₅					0	1	0	1	0	1	0	1	0	1	0	1	0	1	0	1		
B ₄	B ₃	B ₂	B ₁	LU	0	1	2	3	4	5	6	7	8	9	A	B	C	D	E	F		
0	0	0	0	0	☐	☐	☐	☐	☐	☐	☐	☐	☐	☐	☐	☐	☐	☐	☐	☐	☐	
0	0	0	1	1		XON	!	1	A	Q	a	q										
0	0	1	0	2			"	2	B	R	b	r										
0	0	1	1	3		XOFF	#	3	C	S	c	s										
0	1	0	0	4			\$	4	D	T	d	t										
0	1	0	1	5			%	5	E	U	e	u										
0	1	1	0	6			&	6	F	V	f	v										
0	1	1	1	7	BEL		'	7	G	W	g	w										
1	0	0	0	8			(8	H	X	h	x										
1	0	0	1	9	HT)	9	I	Y	i	y										
1	0	1	0	A	LF		*	:	J	Z	j	z										
1	0	1	1	B	VT	ESC	+	;	K	[*	k	{*	HLF	CSI								
1	1	0	0	C	FF		,	<	L	*	l	!*	ST									
1	1	0	1	D	CR		-	=	M]*	m]*										
1	1	1	0	E	SO		.	>	N	~*	n	~*										
1	1	1	1	F	SI		/	?	0	_	o	DEL										DEL

Note: Codes with an asterisk in the table above vary depending on the print band for each country, as follows:

Code Country	X'23'	X'24'	X'40'	X'5B'	X'5C'	X'5D'	X'5E'	X'60'	X'7B'	X'7C'	X'7D'	X'7E'
	U.S.A.	#	S	@	[\]	-	`	{		}
U.K.	£	S	@	[\]	-	`	{		}	-
France	£	S	à	°	ç	§	-	`	é	ù	è	-
Germany	#	S	§	Ä	Ö	Ü	-	`	ä	ö	ü	ß
Sweden	#	Å	É	Ä	Ö	Å	ú	é	ä	ö	å	ü
Denmark	#	S	É	Æ	ø	Å	ú	é	æ	ø	å	ü

6.3.1 Character codes

The ASCII code is used as the standard character code.

If the printer is set in 7-bit mode and the host operates in 8-bit mode, the printer regards the received data as 7-bit data and checks data parity. If the data has a correct parity, the printer prints the data as correct 7-bit data. If not, a transmission error occurs.

When receiving character codes, the printer sequentially loads them in to its interface buffer. Characters corresponding to the loaded character codes are printed after a control code is received. The printed character codes are cleared after printing.

6.3.2 Control codes

The null (NULL), delete (DEL), sound bell (BEL), horizontal tabulation (HT), line feed (LF), vertical tab (VT), forms feed (FF), carriage return (CR), shift out (SO), shift in (SI), and escape (ESC) codes are control codes indicated in the area enclosed with a bold-faced line in Table 6.4.

(1) NULL (X'00') and DEL (X'7F' and X'FF') codes

When receiving either the NULL or DEL code, the printer ignores it, but does not regard it as an invalid control code.

(2) BEL (X'07') code

When receiving the BEL code, the printer sounds the bell for 1.

(3) HT (X'09') code

The HT code is valid if the horizontal tab data is loaded in to the printer with the Load Horizontal Tab Stop Data command. If not, this code is converted to a space code (X'20'). If horizontal tab data is loaded, the horizontal print position is moved to the right tab stop of the current horizontal print position, within the horizontal tab stops specified in the horizontal tab data.

Example 1:

Column	1	2	3	4	5	6	7	8	9	10	11	12	13	14	15	16	17	18
Horizontal tab stop			▼						▼								▼	
Data	A	B	C	D	E	F	G	H	I	J	K	(09)	L	M	N			
Printing	A	B	C	D	E	F	G	H	I	J	K					L	M	N

If horizontal tab data is loaded and there is no right tab stop of the current horizontal print position within the horizontal tab stops specified in the horizontal tab data, this code is also converted to a space code (X'20').

Example 2:

Column	1	2	3	4	5	6	7	8	9	20	21	22	23	24	25	26		
Horizontal tab stop					▼					▼							▼		
Data	A	B	C	D	E	F	G	H	I	A	B	C	(09)	D	E	F		
Printing	A	B	C	D	E	F	G	H	I	A	B	C				D	E	F

(4) LF (X'0A') code

The LF code directs the printer to feed one line. If the printer is receiving print data before receiving this code, it prints the data, then feeds one line.

Example:

Column	1	2	3	4	5	6	7	8	9	10	11	12	13	14	15	16	17	18	19	20
Data	A	B	C	D	E	F	G	(0A)	H	I	J	K	L	M	N	(0A)	O	P	Q	R
Printing	A	B	C	D	E	F	G													
									H	I	J	K	L	M	N					
																	O	P	Q	R

If the setup L.TERM is set to CR/FF, the printer does not return the horizontal print position to column 1. However, if the setup is set to PRTCMD, the printer returns the position to column 1 after printing.

(5) VT (X'0B') code

When receiving the VT code, the printer feeds forms up to the first channel line specified from the operator panel. If the printer is receiving print data before receiving this code, it prints the data, then feeds forms.

This channel can be selected from channels 2 to 12 by setting. For example, if channel 2 is specified by the setup above, the printer skips to channel 2 when receiving the VT code.

The printer can also perform the LF code function when receiving the VT code by setting.

(6) FF (X'0C') code

The FF code directs the printer to feed forms up to the line at the top of on the next page.

If forms control buffer (FCB; in this manual, it is also called EVFU) data is loaded, the line on which channel 1 is specified is the line at the TOF.

If the printer receives print data before receiving this code, it prints the data, then feeds forms. Then, the horizontal print position is set to column 1.

(7) CR (X'0D') code

The CR code sets the horizontal print position in column 1. If the printer receives print data before receiving this code, it prints the data, then sets the horizontal print position to column 1.

If the Automatic New Line on CR Code function is set from the operator panel, the printer feeds one line in addition to performing the operations above.

(8) SO (X'0E') code

The SO code translates character codes X'21' - X'7E' into X'A1' - X'FE'. The SO code is valid if 7SI/SO mode is selected in setup DT BIT from the operator panel. If not, the printer ignores this code, but does not regard it as an invalid code. When receiving the SI code, the printer stops data code translation.

When receiving an SI code after an SI code or when receiving an SO code after an SO code, the printer ignores the second SI or SO code and the printer state does not change whether data codes are to be translated or not.

(9) ESC (X'1B') code

The ESC code indicates that the data following it is control sequence data in 7-bit mode.

For the control sequence, see Section 6.5.

6.4 Message Protocols

The following protocols have been prepared for this printer:

- . XON/XOFF protocol
- . Reverse Channel line (pin 19/11) protocol
- . DTR line protocol
- . RTS line protocol

The protocols above report the interface buffer state (almost empty or almost full) to the host and operate according to the printer start/stop state.

6.4.1 XON/XOFF protocol

The XON/XOFF protocol transmits code X'11' (XON) or code X'13' (XOFF) to the host via the TD line under the following conditions:

Conditions for XON transmission

- DTR is turned from off (1) to on (0).
- The interface buffer is empty or almost empty.

Conditions for XOFF transmission

- The interface buffer is almost full, or
- Before DTR is turned from on to off.

The time from when XOFF is transmitted to when DTR is turned from on to off is 0.5 sec (for 19.2 or 9.6 K baud) or 1 sec (for 2.4 or 4.8 K baud).

For timing details, see Figures 6.5 and 6.6.

6.4.2 Reverse Channel line protocol

When the Reverse Channel signal is on (0), the host can transmit data.

This signal is turned from off to on under the same conditions under which the XON/XOFF protocol transmits code XON.

This signal is turned from on to off under the same conditions which the XON/XOFF protocol transmits code XOFF.

For timing details, see Figures 6.3 and 6.4.

6.4.3 DTR line protocol

The DTR line protocol is the same as the Reverse Channel line protocol.

This signal is turned from off (1) to on (0) under the following conditions:

- . Printer is in the start state and,
- . The interface buffer is empty or almost empty.

This signal is turned from on to off under one of the following conditions:

- . Printer is in the stop state (error occurred, cover open, end of forms, or operator pressed the START/STOP switch) or,
- . The interface buffer is almost full.

Note: If this line protocol is enabled, the printer received data via the RD line whether the DTR signal is on or off.

For timing details, see Figure 6.7.

6.4.4 RTS line protocol

The RTS line protocol is the same as the Reverse Channel line protocol.

This signal is turned from off (1) to on (0) under the following conditions:

- . Printer is in the start state and,
- . The interface buffer is empty or almost empty.

This signal is turned from on to off under one of the following conditions:

- . Printer is in the stop state or,
- . The interface buffer is almost full.

Note: This protocol enables the connection of a printer operating as data terminal equipment (DTE) to a host operating as DTE. However, this protocol is not used to connect this printer to a host operating as data circuit terminating equipment (DCE). In addition, this printer ignores a Status Request command when this protocol is enabled.

For timing details, see Figure 6.8.

6.5 Commands

When detecting one of the control sequences listed in Table 6.5, the printer regards it as a command and starts the command operation.

Table 6.5 Commands and their control sequences

Command name	Control sequence	
	7-bit mode	8-bit mode
Load FCB (EVFU) Data	1B 50 23 (PS) 1B 5C	90 23 (PS) 9C
Select Vertical Pitch	1B 5B (P) 20 47	9B (P) 20 47
Set to Initial State	1B 63	
Skip to Channel-n	1B 50 22 (P) 1B 5C	90 22 (P) 9C
Move Horizontal Position	1B 5B (P) 61	9B (P) 61
Space n-Lines	1B 5B (P) 65	9B (P) 65
Load Horizontal Tab Stop Data	1B 5B (PS) 20 4E	9B (PS) 20 4E
Status Request	1B 5B 70	9B 70
Status Response	1B 50 24 (PS) 1B 5C	90 24 (PS) 9C
Half Line Feed	1B 4B	8B
Repeat Character	1B 5B (P) 62	9B (P) 62

Note: P indicates a parameter, and PS indicates a parameter sequence. For their details, refer to the explanations of the commands listed in the table above.

(1) Load FCB (EVFU) Data command

The Load FCB (EVFU) Data command loads forms control data into the forms control buffer (FCB).

The forms control data is channel data. Channels 1 to 12 can be selected for channel data.

(2) Select Vertical Pitch command

The Select Vertical Pitch command specifies the printer line feed pitch (6 or 8 lpi).

When 6 lpi is specified, the parameter is 31 32 30, as follows:

1B 5B }
or }
9B } 31 32 30 20 47
 ↑
 Parameter

When 8 lpi is specified, the parameter is 39 30, as follows:

1B 5B }
or }
9B } 39 30 20 47
 ↑
 Parameter

If the parameter has a value other than the value above, it is regarded as an invalid control sequence and the specified operation is not performed.

(3) Set to Initial State command

The Set to Initial State command returns the FCB (EVFU) contents to the set value, clears the horizontal control buffer (HCB) in which the horizontal tab stop data is loaded, returns the printer line feed pitch to that specified by the setting, and inhibits the printer from translating data codes when the printer receives the S0 code.

However, an error caused by the printer, for example, hammer check or band speed check, is not cleared.

(4) Skip to Channel-n command

The skip to Channel-n command directs the printer to feed forms up to the line corresponding to the channel specified in the FCB data after data received before this command is printed. The channel number is specified by the parameter as follows:

X'31'	→	Channel 1	X'37'	→	Channel 7
X'32'	→	Channel 2	X'38'	→	Channel 8
X'33'	→	Channel 3	X'39'	→	Channel 9
X'34'	→	Channel 4	X'31 30'	→	Channel 10
X'35'	→	Channel 5	X'31 31'	→	Channel 11
X'36'	→	Channel 6	X'31 32'	→	Channel 12

This control sequence is regarded as invalid under the following conditions:

- . The channel specified in this command is not present in the FCB (EVFU) even though the FCB (EVFU) is loaded.
- . This command is specified even though the FCB is not loaded. If channel 1 is specified, however, the printer prints received data and feeds forms up to the TOF line.

. A channel other than channels 1 to 12 is specified.

. Parameters are not defined.

Under the conditions above, the printer regards the control sequence as invalid, and prints received data and feeds one line.

(5) Move Horizontal Position command

The Move Horizontal Position command moves the horizontal print position according to the following calculation:

The horizontal print position + column count specified in the parameter. The parameter is defined as follows:

X'31'	—————>	1 column	X'31 30 30'	—————>	100 columns
X'32'	—————>	2 columns	.		
X'33'	—————>	3 columns	.		
			.		
			X'31 31 34'	—————>	134 columns
			X'31 31 35'	—————>	135 columns
			X'31 31 36'	—————>	136 columns
X'39'	—————>	9 columns			
X'31 30'	—————>	10 columns			
X'31 31'	—————>	11 columns			
⋮					
X'39 39'	—————>	99 columns			

Example 1:

Column	1	2	3	4	5	6	7	8	9	10	11	12	13	14	15	16	17	18	19
Data	A	B	C	D	E	F	9B	<u>31</u>	<u>30</u>	61	G	H	I	<u>0A</u>					
								Parameter						LF code					
								Command											

Printing A B C D E F G H I

If the value obtained by adding the value specified in the parameter to the horizontal print position exceeds the right margin value, the printer performs one of the following operations:

a. If the New Line on Right Margin function is set:

The printer performs the New Line on Right Margin function to print data and feed one line, and sets the horizontal print position according to the following calculation: $x + 1$; where

$x = \text{Current horizontal print position} + (\text{Parameter value}) - \text{Right margin.}$

Example 2:

Right margin 136

Column 1 2 3 4 5 6 7 8 9 133 134 135 136

Data A B C D E F G H I A 9B 31 30 61 B C D OA

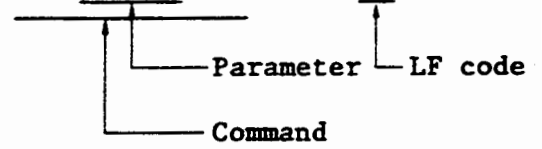

Printing A B C D E F G H I A

B C D

b. If the New Line on Right Margin function is not set:

A right margin overflow error occurs. The printer prints data and feeds one line, then stops.

Example 3:

Column 1 2 3 4 5 6 7 8 9 133 134 135 136

Data A B C D E F G H I A 9B 31 30 61 B C D

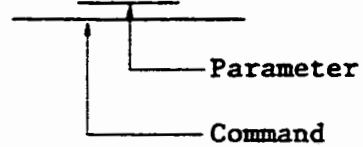

Printing A B C D E F G H I A

In this example, the printer stops before processing data B C D.

(6) Space n-Line command

The Space n-Line command directs the printer to feed as many lines as specified in the parameter. After printing data received before this command, the printer feeds forms.

The parameter is defined as follows:

X'30'	→	No line	X'39 39'	→	99 lines
X'31'	→	1 line	X'31 30 30'	→	100 lines
X'32'	→	2 lines	X'31 30 31'	→	101 lines
⋮		⋮	⋮		⋮
X'39'	→	9 lines	X'31 32 36'	→	126 lines
X'31 30'	→	10 lines	X'31 32 37'	→	127 lines
X'31 31'	→	11 lines			
⋮		⋮			

(7) Load Horizontal Tab Stop Data command

The Load Horizontal Tab Stop Data command loads horizontal tab stop data into the horizontal control buffer (HCB).

Example:

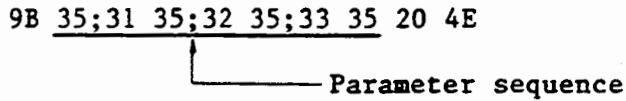

Codes used in the parameter sequence are the same as those of the Load FCB Data command. Code 35 in the parameter sequence above indicates that the horizontal tab stop is to be set at column 5. Code 31 35 indicates that the horizontal tab stop is to be set at column 15. Using this parameter, the horizontal tab stop is set at columns 5, 15, 25, and 35.

If the column for the horizontal tab stop exceeds the right margin, the printer regards it as an invalid horizontal tabulation load data command and clears the horizontal control buffer.

(8) Status Request command

The Status Request command directs the printer to report its status to the host. Even if the DTR signal is off, the printer can receive this command and report printer status.

If the XON/XOFF, Reverse Channel line, or DTR line protocol is used and the host receives code XOFF from the printer, or if the Reverse Channel is off (for example, the printer interface buffer is almost full) and the host transmits this command, the interface can be used efficiently.

(9) Status Response command

The Status Response command, in response to the Status Request command transmitted from the host, reports the printer status in the following format:

Example:

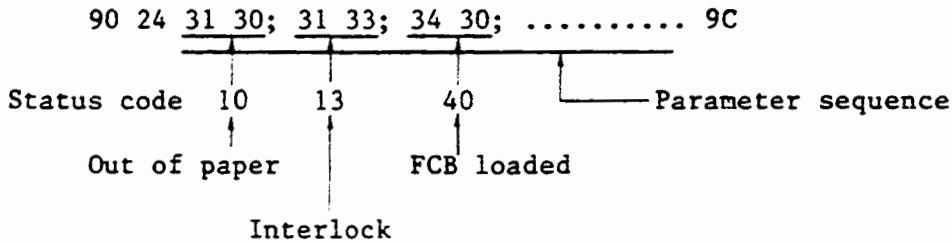

Codes used in the parameter sequence above are the same as those of the Load FCB Data command. Status codes in the parameter sequence are separated with semicolons (;).

For status code details, see Section 6.6.

6.6 Printer Status

Table 6.6 lists printer status responses for the Status Request command the reset condition of each status.

Table 6.6 Printer status

Status code	Printer status	Description	Error/Status
1	Odd half space	. The printer in 6 lpi mode performed, the half line feed function and the printing line is at (TOF + N inch + 1/12, 3/12, 5/12, 7/12, 9/12, or 11/12 inches).	Status
4	FUSE	The fuse was blown.	Error
5	HMRCHK (Hammer error)	A hammer error occurred. Call a Fujitsu customer engineer.	Error
7	FAN (Blower error)	The fan inside the printer stopped.	Error
10	FORM (Forms end)	The forms are out.	Error
	STACKR (Stacker full)	The stacker is full of forms.	Error
11	JAM (Forms jam)	Forms jam occurred.	Error
12	RIBBON (Ribbon error)	Ribbon jam occurred, or no ribbon has not been set yet.	Error
13	INTRLK (Interlock)	The throat or band cover was opened.	Error
	ITLKER (Interlock error)	The throat or band cover was opened during printing.	Error
	COVER	The top cover was opened.	Error
14	BAND (Band speed check)	The band speed is abnormal.	Error
15	SYNCH (Band sync. error)	The control circuit lost band synchronous control.	Error
16	BAND (Band error)	. When the band was operated, it did not rotate. .-A band error other than the above error occurred.	Error
19	FCTERR (FCI error)	FCTI was not correctly read.	Error
25	Not top of forms	Channel 1 was not in the Load FCB (EVFU) data.	Error
28	NOCHNL (Channel selected, but channel not loaded)	The printer tried to execute the Skip to Channel n command, but the channel was not in the FCB.	Error

Table 6.6 Printer status - continued

Status code	Printer status	Description	Error/Status
29	NOCHNL (Channel selected, but FCB Not loaded)	The printer tried to execute the Skip to Channel n command, but FCB (EVFU) was not loaded.	Error
30	NOCHNL (Illegal channel)	The printer tried to execute the Skip to Channel n command, but the specified channel number was not 1 to 12.	Error
	LDERR (Illegal channel)	The specified channel number in the load FCB (EVFU) data was not 1 to 12. The printer regards it as an LDERR error.	Error
31	Invalid character code	An invalid character code occurred. The printer does not regard it as an error and does not stop. It is converted into X'20'.	Status
35	FUSE (Fuse 3 and fuse 4)	The forms feed fuse was blown. The printer regards it as an error and stops.	Error
36	FUSE (Fuse 1)	The hammer drive fuse was blown. The printer regards it as an error and stops.	Error
39	Form length mode	. The printer is in this status before the Load FCB Data command is issued from the host, or before FCB image data is loaded by the FCT.	Status
40	FCB mode	. The printer received load FCB (EVFU) data and wrote the data in the FCB in the printer. . The printer is put in this status only when the FCB data is correct. If not, the status code is 39.	Status
41	Tape load FCB mode	. The FCB image data was loaded by FCT, and written in FCB. . If the data is not correct, the status data is 39.	Status
43	I/O select 6/8 lines per inch	. The line feed pitch was designated as 6 or 8 lpi by printer setting. . When correctly receiving the Set Vertical Pitch command from the host, the printer is put in the lpi status that the host designates. At that time, the printer does not transmit this status code (43) to the host.	Status
44	6 lines per inch	The printer is in 6 lpi mode.	Status
45	8 lines per inch	The printer is in 8 lpi mode.	Status
48	Auto-perforation skip enabled	The perforation skip function is enabled.	Status
49	Vert. tab Sel. channel 3	VI = channel 3	Status
50	Vert. tab Sel. channel 4	VI = channel 4	Status

Table 6.6 Printer status - continued

Status code	Printer status	Description	Error/Status
52	BOF channel 2	BOF = channel 2	Status
53	BOF channel 8	BOF = channel 8	Status
54	BOF channel 12	BOF = channel 12	Status
58	48 BAND	The 48-character set print band is mounted on the printer.	Status
59	64 BAND	The 64-character set print band is mounted on the printer.	Status
60	96 BAND	The 96-character set print band is mounted on the printer.	Status
61	128 BAND	The 128-character set print band is mounted on the printer.	Status
66	2K input buffer	The printer interface buffer is 2K bytes.	Status
68	SO/SI enabled	The SI/SO mode was enabled by setting.	Status
69	New line on CR enabled	When the CR code is received, the function which converts it to CR + LF becomes enabled.	Status
70	New line on right margin enabled	The new line on right margin function is enabled.	Status
71	Convert VT to LF enabled	When the VT code is received, the function which converts it to the LF code is enabled.	Status
72	Lower case translation enabled		Status
74	Stop on invalid control code enabled	When an invalid control code is received, an error occurs, and the printer stops.	Status
75	Substitute on invalid control code enabled	When receiving an invalid control code, the printer converts it to the code specified by the setting.	Status
77	Stop on invalid control sequence enabled	This status code is the same manner as that of status 74.	Status
78	Substitute on invalid control sequence enabled	This status code is the same manner as that of status 75.	Status
80	Stop on transmission error enabled	This status code is the same manner as that of status 74.	Status
81	Substitute on transmission error enabled	This status code is the same manner as that of status 75.	Status
82	Even parity enabled	The interface parity is even.	Status
83	Odd parity enabled	The interface parity is odd.	Status

Table 6.6 Printer status - continued

Status code	Printer status	Description	Error/Status
85	Monitor Data Set Ready		Status
86	Monitor received line signal detector		Status
87	RTS with wait for CTS		Status
88	RTS without wait for CTS		Status
89	RTS constant ON with wait for CTS		Status
90	RTS constant ON without wait for CTS		Status
93	Prop DTR mode Enable	Drop DTR with START/STOP switch mode is enabled.	Status
94	XON/XOFF enabled	The message protocol XON/XOFF is enabled.	Status
95	Reverse channel enabled Reverse channel line almost full = on	The message protocol Reverse Channel is enabled. When this signal is on, the interface buffer is almost full.	Status
96	Reverse channel enabled Reverse channel line almost full = off	The message protocol Reverse Channel signal is enabled. When this signal is on, the interface buffer is almost empty.	Status
98	Transmission error	If status 80 is selected, the printer stops, therefore, the BUFFER CLEAR switch is enabled.	Error, Status
99	Invalid control code	This status code is the same manner as that of the above status code.	Error, Status
100	Invalid control sequence	This status code is the same manner as that of the above status code.	Error, Status
101	Buffer overflow	The interface buffer overflowed. The printer abandons the data after the buffer overflows.	Error
102	Right margin overflow	When the right margin function is disabled, and the received data exceeds the right margin, the printer reports this status. However, if this function is enabled, the printer prints the data which exceeds the right margin on the next line, and does not report this status.	Error
103	Invalid HT load		Error
104	Invalid EVFU load		Error

Table 6.6 Printer status - continued

Status code	Printer status	Description	Error/ Status
105	Data terminal ready	If the DTR signal is on, the printer reports this status.	Status
106	Printer stop state	When the START/STOP switch is pressed and the printer stops printing (stop state), the printer reports this status.	Status
107	Printer error stop state	When an error occurs on the printer and the printer stops printing, the printer reports this status.	Status

CHAPTER 7 PRINT BAND SPECIFICATIONS

This chapter shows the following:

- . Standard print band list; Shows the print bands for the M304x series.
- . Standard character sets; Shows the character arrangement of each print band.

(Example)

US ASCII 64 — ①
Specification No.: B300-2930-T112A ②
Reference type catalog No.: B30U-2930-0112A ③

1	10	20	30
O < H 9 W G 8 ! F 7 ? E 6 : D 5 ; C , [B 4 (A 3 > Z 2 = Y - \$ X -)]			

40	50	60 ④	64
O & V / _ U * @ T . ' S \ M R I L Q ^ K P % J O # I N "			

- ① Classification of print band
- ② Specification No.
- ③ Reference type catalog number
- ④ Character arrangement

. Type catalog

Shows the character forms of each print band.

Therefore, this character form shows at designing not at printing. Thickness and density, etc. of the character is not shown.

7.1 Standard Print Band List

Specification	Remarks
B300-2930-T112A B300-2930-T604A B300-2930-T605A B300-2930-T609A	US ASCII 64 char US ASCII 64 char, OCR-B US ASCII 64 char, I-font US ASCII 64 char, Pica 10
B300-2930-T637A	US ASCII 64 char, OCR-A
B300-2930-T113A B300-2930-T602A B300-2930-T606A B300-2930-T610A	US ASCII 96 char US ASCII 96 char, OCR-B US ASCII 96 char, I-font US ASCII 96 char, Pica 10
B300-2930-T137A B300-2930-T603A B300-2930-T607A	UK ASCII 64 char UK ASCII 64 char, OCR-B UK ASCII 64 char, I-font
B300-2930-T138A B300-2930-T601A B300-2930-T608A	UK ASCII 96 char UK ASCII 96 char, OCR-B UK ASCII 96 char, I-font
B300-2930-T123A B300-2930-T619A	German ASCII 64 char German ASCII 64 char, OCR-B
B300-2930-T641A	German ASCII 64 char, OCR-A
B300-2930-T124A B300-2930-T614A B300-2930-T620A	German ASCII 96 char German ASCII 96 char, Pica 10 German ASCII 96 char, OCR-B
B300-2930-T215A	French ASCII 64 char
B300-2930-T216A	French ASCII 96 char
B300-2930-T127A B300-2930-T617A	Swedish ASCII 64 char Swedish ASCII 64 char, OCR-B
B300-2930-T128A B300-2930-T618A	Swedish ASCII 96 char Swedish ASCII 96 char, OCR-B
B300-2930-T129A	Danish ASCII 64 char
B300-2930-T130A	Danish ASCII 96 char

7.2 Standard Character Sets

US ASCII 64 char

Specification No.: B300-2930-T112A

Reference type catalog No.: B30U-2930-0112A

US ASCII 64 char, OCR-B
Specification No.: B300-2930-T604A
Reference type catalog No.: B30U-2930-0604A

US ASCII 64 char, I-font
Specification No.: B300-2930-T605A
Reference type catalog No.: B30U-2930-0605A

US ASCII 64 char, Pica 10
Specification No.: B300-2930-T609A
Reference type catalog No.: B30U-2930-0609A

1	10	20	30
0 < H 9 W G 8 ! F 7 ? E 6 : D 5 ; C , [B 4 (A 3 > Z 2 = Y + \$ X -)] O & V			

40	50	60	64
/ _ U * @ T . ' S \ M R I L Q ^ K P % J O # I N "			

US ASCII 64 char, OCR-A
Specification No.: B300-2930-T637A
Reference type catalog No.: B30U-2930-0637A

1	10	20	30
0 < H 9 W G 8 ! F 7 ? E 6 : D 5 ; C , [B 4 (A 3 > Z 2 = Y + \$ X -)] O & V			

40	50	60	64
/ Y U * @ T . ' S \ M R I L Q ^ K P % J O # I N "			

US ASCII 96 char
Specification No.: B300-2930-T113A
Reference type catalog No.: B30U-2930-0113A

US ASCII 96 char, OCR-B
Specification No.: B300-2930-T602A
Reference type catalog No.: B30U-2930-0602A

US ASCII 96 char, I-font
Specification No.: B300-2930-T606A
Reference type catalog No.: B30U-2930-0606A

US ASCII 96 char, Pica 10
Specification No.: B300-2930-T610A
Reference type catalog No.: B30U-2930-0610A

1	10	20	30	
0 < H 9 W G 8 ! F 7 ? E 6 : D 5 ; C , [B 4 (A 3 > Z 2 = Y + \$ X -)] O & V				
40	50	60	64 65	74
/ _ U * @ T . ' S \ M R I L Q ^ K P % J O # I N " ` e j o t y ~ a f k p u z b				
84	94	96		
g l q v 0 { c h m r w d i n s x }				

UK ASCII 64 char
Specification No.: B300-2930-T137A
Reference type catalog No.: B30U-2930-0137A

UK ASCII 64 char, OCR-B
Specification No.: B300-2930-T603A
Reference type catalog No.: B30U-2930-0603A

UK ASCII 64 char, I-font
Specification No.: B300-2930-T607A
Reference type catalog No.: B30U-2930-0607A

1	10	20	30
0 < H 9 W G 8 ! F 7 ? E 6 : D 5 ; C , [B 4 (A 3 > Z 2 = Y + \$ X -)] O & V			
40	50	60	64
/ _ U * @ T . ' S \ M R I L Q ^ K P % J O E I N "			

UK ASCII 96 char
Specification No.: B300-2930-T138A
Reference type catalog No.: B30U-2930-0138A

UK ASCII 96 char, OCR-B
Specification No.: B300-2930-T601A
Reference type catalog No.: B30U-2930-0601A

UK ASCII 96 char, I-font
Specification No.: B300-2930-T607A
Reference type catalog No.: B30U-2930-0607A

1	10	20	30
0 < H 9 W G 8 ! F 7 ? E 6 : D 5 ; C , [B 4 (A 3 > Z 2 = Y + \$ X -)] O & V			

40	50	60	64 65	74
/ _ U * @ T . ' S \ M R I L Q ^ K P % J O £ I N " ` e j o t y ~ a f k p u z b				

84	94	96
g l q v 0 { c h m r w d i n s x }		

German ASCII 64 char
Specification No. B300-2930-T123A
Reference type catalog No.: B30U-2930-0123A

German ASCII 64 char, OCR-B
Specification No.: B300-2930-T619A
Reference type catalog No.: B30U-2930-0619A

1	10	20	30
0 < H 9 W G 8 ! F 7 ? E 6 : D 5 ; C , Ä B 4 (A 3 > Z 2 = Y + \$ X -) Ü O & V			

40	50	60	64
/ _ U * § T . ' S Ö M R I L Q ^ K P % J O # I N "			

German ASCII 64 char, OCR-A
Specification No.: B300-2930-T641A
Reference type catalog No.: B30U-2930-0641A

1	10	20	30
0 < H 9 W G 8 ! F 7 ? E 6 : D 5 ; C , Ä B 4 (A 3 > Z 2 = Y + \$ X -) Ü O & V			

40	50	60	64
/ Y U * § T . ' S Ö M R I L Q ^ K P % J O # I N "			

German ASCII 96 char
Specification No.: B300-2930-T124A
Reference type catalog No.: B30U-2930-0124A

German ASCII 96 char, Pica 10
Specification No.: B300-2930-T614A
Reference type catalog No.: B30U-2930-0614A

German ASCII 96 char, OCR-B
Specification No.: B300-2930-T620A
Reference type catalog No.: B30U-2930-0620A

1	10	20	30	
0 < H 9 W G 8 ! F 7 ? E 6 : D 5 ; C , Ä B 4 (A 3 > Z 2 = Y + \$ X -) Ü O & V				
40	50	60	64 65	74
/ _ U * § T . ' S Ö M R I L Q ^ K P % J O # I N " ` e j o t y ß a f k p u z b				
84	94	96		
g l q v 0 ä c h m r w ö d i n s x ü				

French ASCII 64 char
Specification No.: B300-2930-T125A
Reference type catalog No.: B30U-2930-0125A

1	10	20	30
0 < H 9 W G 8 ! F 7 ? E 6 : D 5 ; C , ° B 4 (A 3 > Z 2 = Y + \$ X -) § O & V			
40	50	60	64
/ _ U * á T . ' S ç M R I L Q ^ K P % J O £ I N "			

French ASCII 96 char
Specification No. B300-2930-T126A
Reference type catalog No.: B30U-2930-0126A

1	10	20	30	
0 < H 9 W G 8 ! F 7 ? E 6 : D 5 ; C , ° B 4 (A 3 > Z 2 = Y + \$ X -) § O & V				
40	50	60	64 65	74
/ _ U * ä T . ' S ç M R I L Q ^ K P % J O £ I N " ` e j o t y " a f k p u z b				
84	94	96		
g l q v o é c h m r w ü d i n s x è				

Swedish ASCII 64 char
Specification No.: B300-2930-T127A
Reference type catalog No.: B30U-2930-0127A

Swedish ASCII 64 char, OCR-B
Specification No.: B300-2930-T617A
Reference type catalog No.: B30U-2930-0617A

1	10	20	30
0 < H 9 W G 8 ! F 7 ? E 6 : D 5 ; C , Ä B 4 (A 3 > Z 2 = Y + X -) Å 0 & V			
40	50	60	64
/ _ U * É T . ' S Ö M R I L Q Ü K P % J O # I N "			

Swedish ASCII 96 char
Specification No.: B300-2930-T128A
Reference type catalog No.: B30U-2930-0128A

Swedish ASCII 96 char, OCR-B
Specification No.: B300-2930-T618A
Reference type catalog No.: B30U-2930-0618A

1	10	20	30	
0 < H 9 W G 8 ! F 7 ? E 6 : D 5 ; C , Ä B 4 (A 3 > Z 2 = Y + X -) Å 0 & V				
40	50	60	64 65	74
/ _ U * É T . ' S Ö M R I L Q Ü K P % J O # I N " è e j o t y ü a f k p u z b				
84	94	96		
g l q v 0 ä c h m r w ö d i n s x å				

Danish ASCII 64 char
Specification No.: B300-2930-T129A
Reference type catalog No.: B30U-2930-0129A

1	10	20	30
0 < H 9 W G 8 ! F 7 ? E 6 : D 5 ; C , Æ B 4 (A 3 > Z 2 = Y + \$ X -) Å 0 & V			
40	50	60	64
/ _ U * É T . ' S O M R I L Q U K P % J O # I N "			

7.3 Type Catalog

B30U-2930-0112A/0113A

US ASCII print band

Print band specification: B300-2930-T112A (63 characters)
: B300-2930-T113A (94 characters)

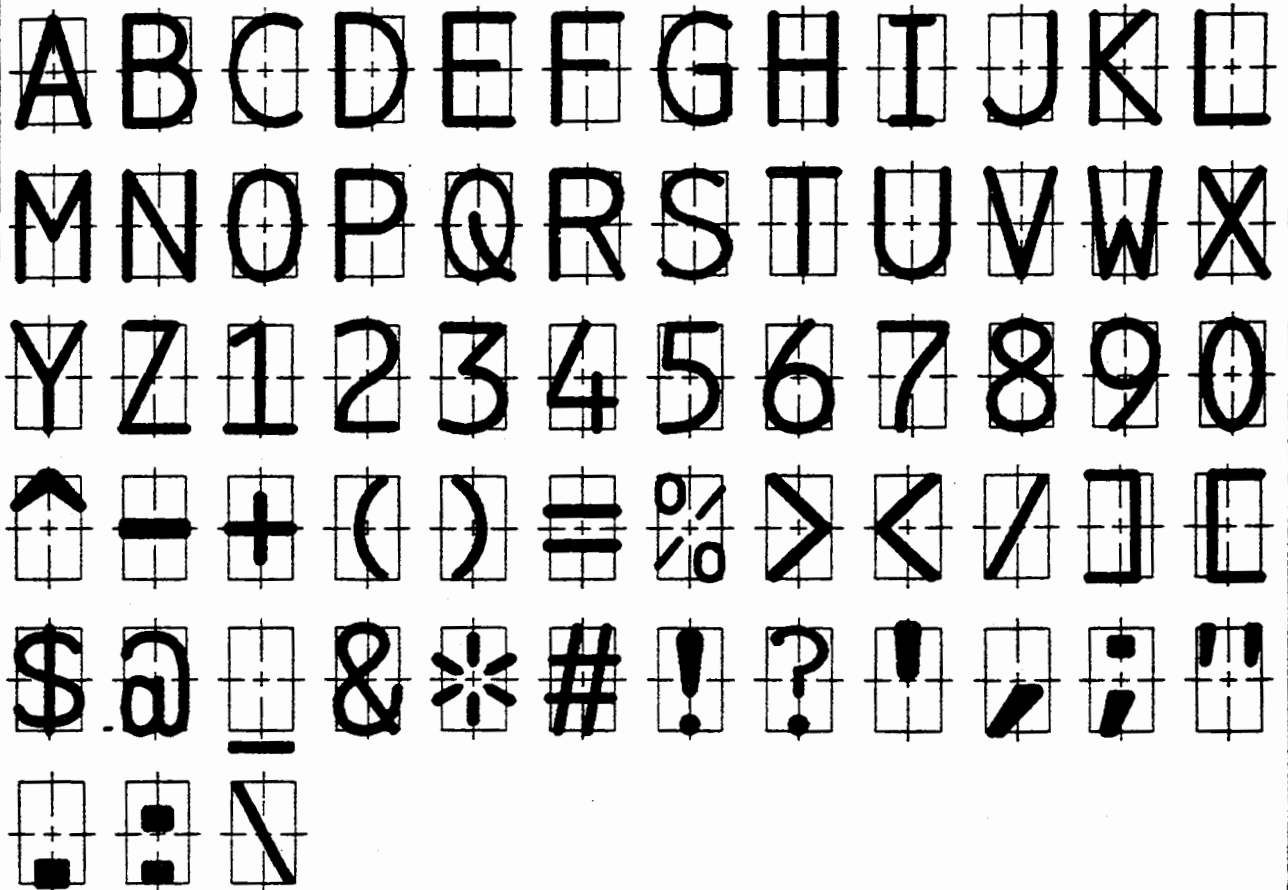

Note: Following characters are provided only for B300-2930-T113A.

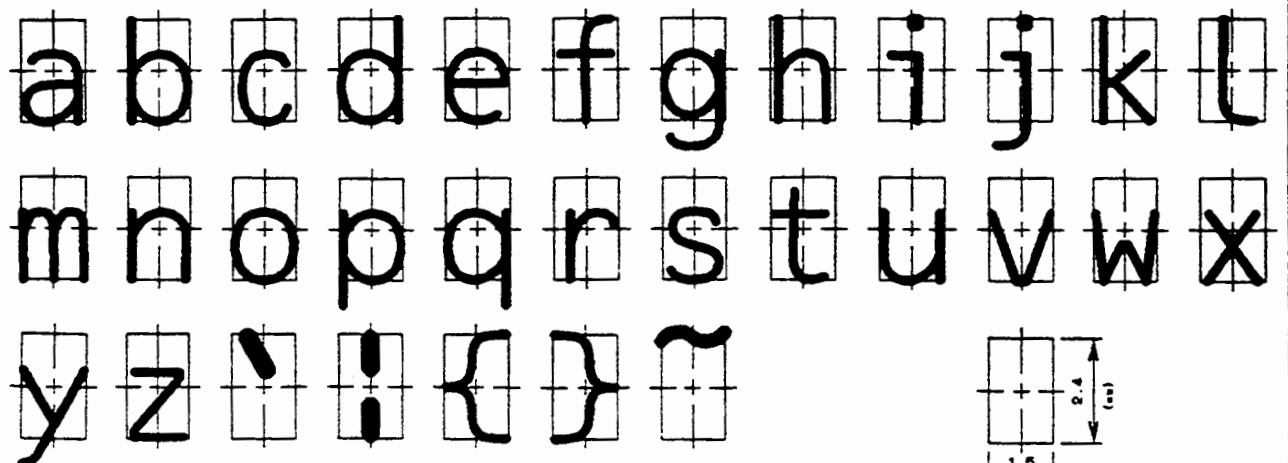

US ASCII 64 ch, OCR-B, print band

Print band specification: B300-2930-T604A

A	B	C	D	E	F	G	H	I	J	K	L
M	N	O	P	Q	R	S	T	U	V	W	X
Y	Z	1	2	3	4	5	6	7	8	9	0
!	?	-	+	()	%	>	<	/	&	*
=	!	/	;	"	.	:	□	#	\$	@	□
□	\	^					-				

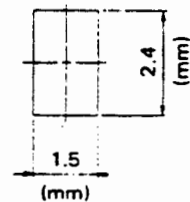

UA ASCII 64 ch, I-font, print band

Print band specification: B300-2930-T605A

A	B	C	D	E	F	G	H	I	J	K	L
M	N	O	P	Q	R	S	T	U	V	W	X
Y	Z	1	2	3	4	5	6	7	8	9	0
!	?	-	+	()	%	>	<	/	&	*
=	!	,	;	"	•	:	□	#	\$	@	□
□	□	□									

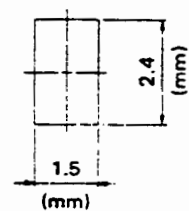

UA ASCII 64 ch, OCR-A, print band

Print band specification: B300-2930-T637A

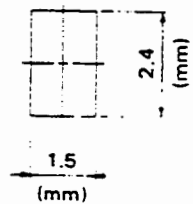
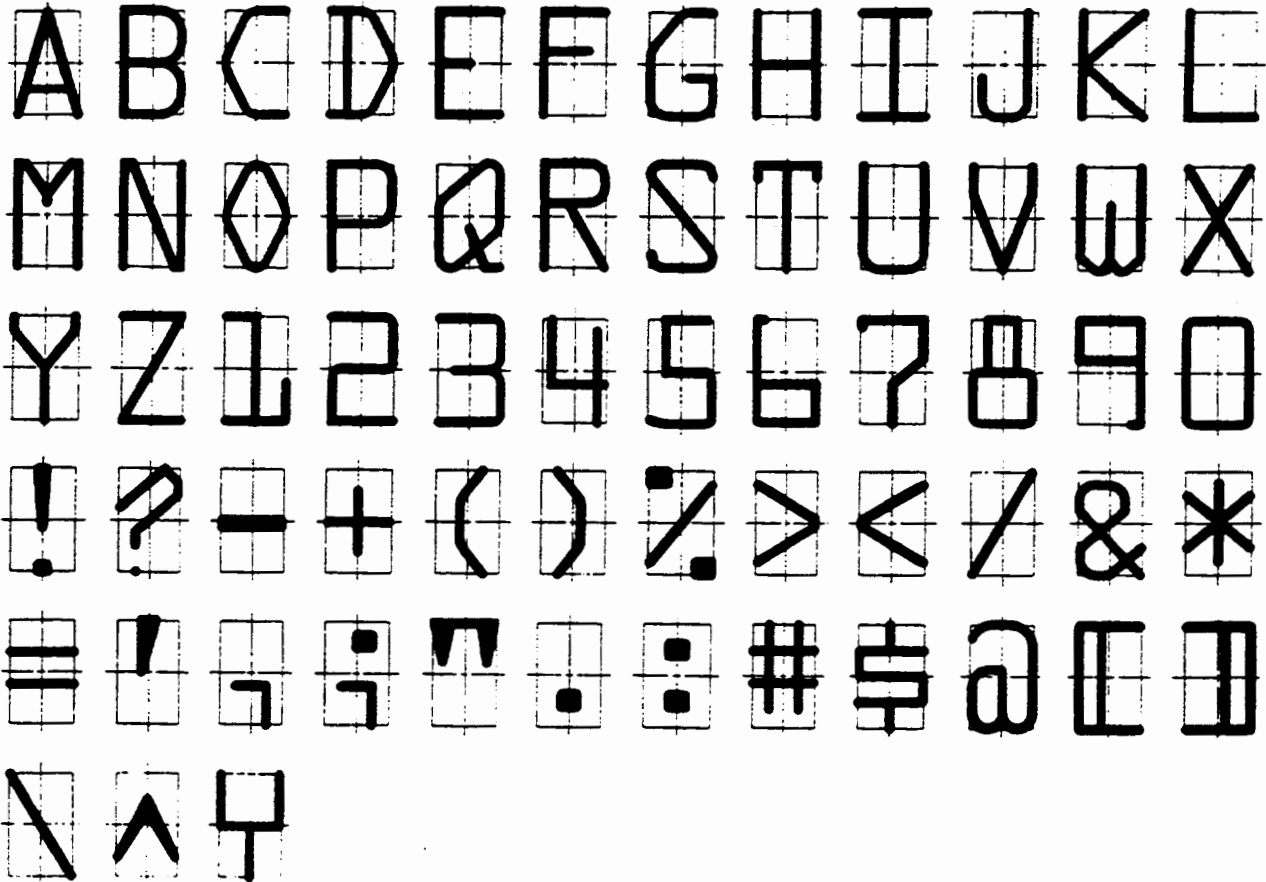

US ASCII 96 ch, OCR-B, print band

Print band specification: B300-2930-T602A

A	B	C	D	E	F	G	H	I	J	K	L
M	N	O	P	Q	R	S	T	U	V	W	X
Y	Z	1	2	3	4	5	6	7	8	9	0
a	b	c	d	e	f	g	h	i	j	k	l
m	n	o	p	q	r	s	t	u	v	w	x
y	z	.	?	(+)	-	"	%	!	\
[\$]	'	!	@	,	:	&	;	/	^
<	=	>	_		~	{	*	}	#		

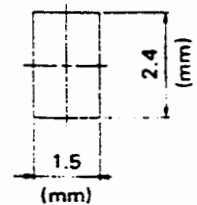

UA ASCII 96 ch, Pica 10, print band

Print band specification: B300-2930-T610A

A	B	C	D	E	F	G	H	I	J	K	L
M	N	O	P	Q	R	S	T	U	V	W	X
Y	Z	1	2	3	4	5	6	7	8	9	0
a	b	c	d	e	f	g	h	i	j	k	l
m	n	o	p	q	r	s	t	u	v	w	x
y	z	!	?	-	+	()	%	<	>	/
&	*	=	!	,	;	"	.	:	□	#	\$
@	[]	/	^	{	}		~	□	□	□

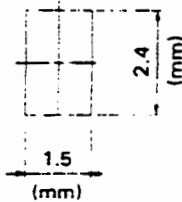

U.K. ASCII print band

Print band specification: B300-2930-T137A (63 characters)
: B300-2930-T138A (94 characters)

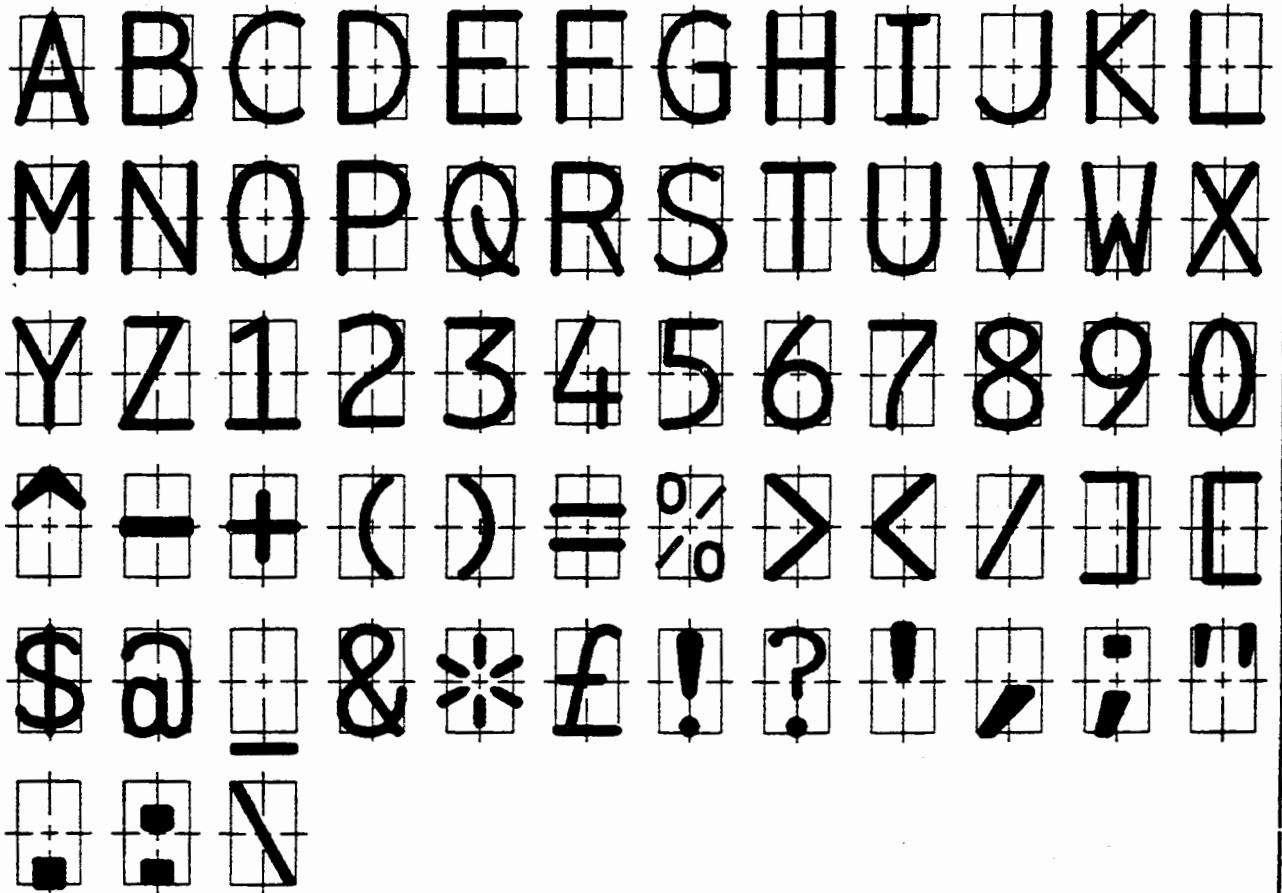

Note: Following characters are provided only for B300-2930-T138A.

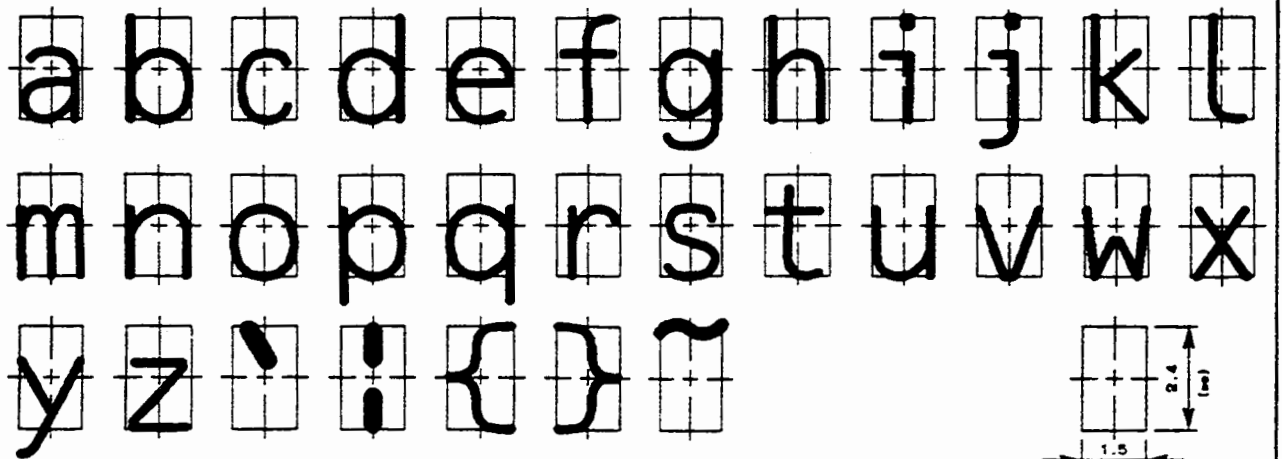

UK ASCII 64 ch, OCR-B, print band

Print band specification: B300-2930-T603A

A	B	C	D	E	F	G	H	I	J	K	L
M	N	O	P	Q	R	S	T	U	V	W	X
Y	Z	1	2	3	4	5	6	7	8	9	0
!	?	-	+	()	%	>	<	/	&	*
=	!	/	,	"	•	•	□	£	\$	ω	⌈
⌋	\	^									

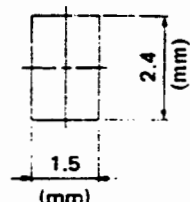

B30U-2930-0607A

UK ASCII 64 ch, I-font, print band

Print band specification: B300-2930-T607A

A	B	C	D	E	F	G	H	I	J	K	L
M	N	O	P	Q	R	S	T	U	V	W	X
Y	Z	1	2	3	4	5	6	7	8	9	0
!	?	-	+	()	%	>	<	/	&	*
=	!	,	;	"	•	:	□	£	\$	¤	□
□	□	□	□	□	□	□	□	□	□	□	□

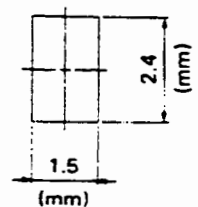

UK ASCII 96 ch, OCR-B print band

Print band specification: B300-2930-T601A

A	B	C	D	E	F	G	H	I	J	K	L
M	N	O	P	Q	R	S	T	U	V	W	X
Y	Z	1	2	3	4	5	6	7	8	9	0
a	b	c	d	e	f	g	h	i	j	k	l
m	n	o	p	q	r	s	t	u	v	w	x
y	z	.	?	(+)	-	"	%	!	\
[\$]	'	!	@	,	:	&	;	/	^
<	=	>	_		~	{	*	}	£		

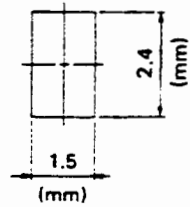

UK ASCII 96 ch, I-font, print band

Print band specification: B300-2930-T608A

A	B	C	D	E	F	G	H	I	J	K	L
M	N	O	P	Q	R	S	T	U	V	W	X
Y	Z	1	2	3	4	5	6	7	8	9	0
a	b	c	d	e	f	g	h	i	j	k	l
m	n	o	p	q	r	s	t	u	v	w	x
y	z	!	?	-	+	()	%	>	<	/
&	*	=	!	,	;	"	•	:	!	£	\$
@	[]	\	^	}	{		~	.		

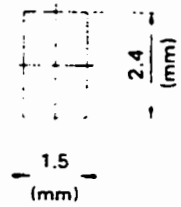

German ASCII print band

Print band specification: B300-2930-T123A (63 characters)
: B300-2930-T124A (94 characters)

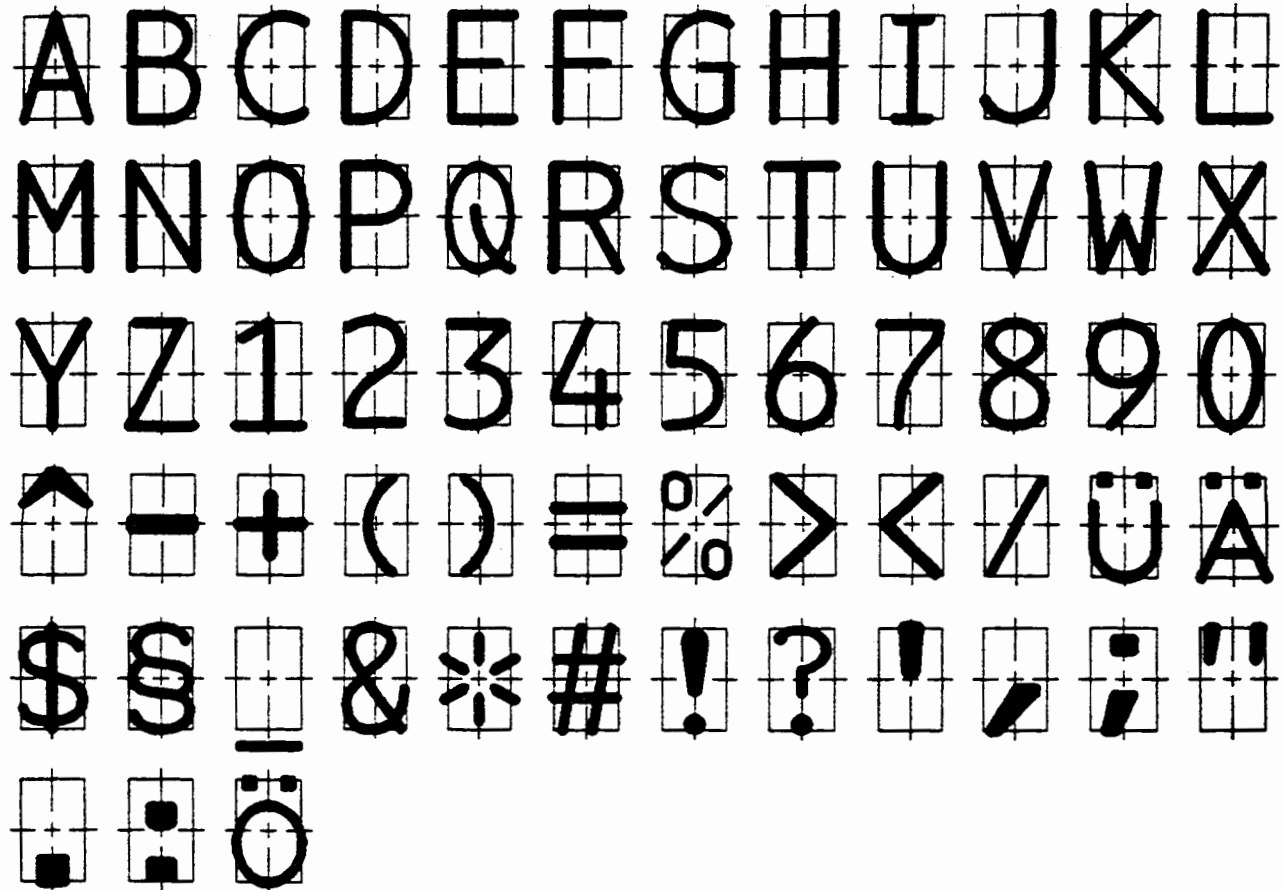

Note: Following characters are provided only for B300-2930-T124A.

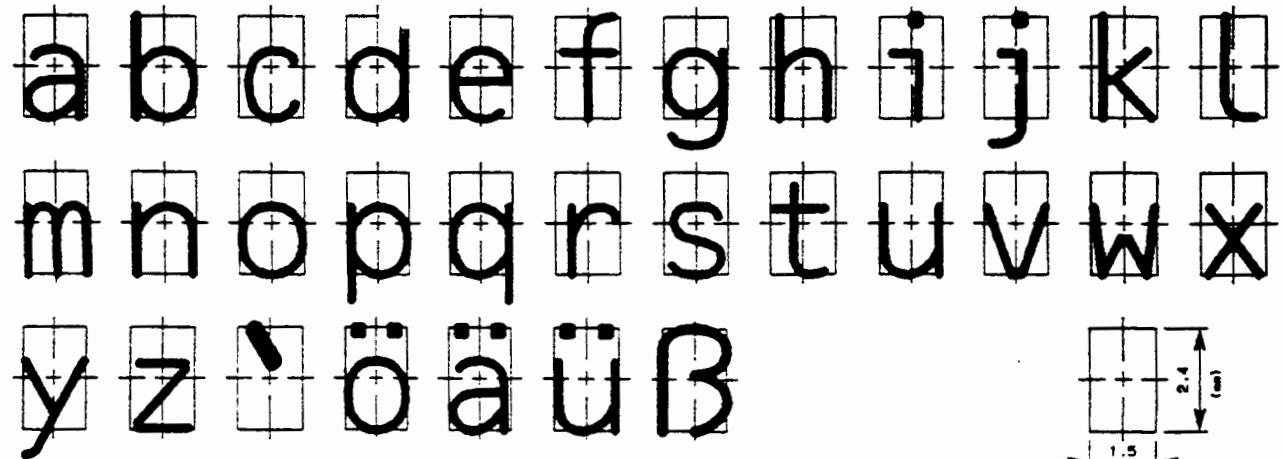

B30U-2930-0619A

German ASCII 64 ch, OCR-B, print band

Print band specification: B300-2930-T619A

A	B	C	D	E	F	G	H	I	J	K	L
M	N	O	P	Q	R	S	T	U	V	W	X
Y	Z	1	2	3	4	5	6	7	8	9	0
.	?	(+)	-	"	%	!	!	#	*
>	=	<	/	,	:	&	;	_	\$	^	§
Ä	Ö	Ü									

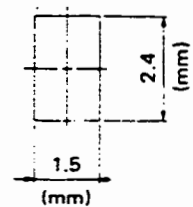

German ASCII 64 ch, OCR-A, print band

Print band specification: B300-2930-T641A

A	B	C	D	E	F	G	H	I	J	K	L
M	N	O	P	Q	R	S	T	U	V	W	X
Y	Z	1	2	3	4	5	6	7	8	9	0
!	?	-	+	()	%	>	<	/	&	*
=	!	~	ı	ˆ	•	˙	#	§	§	^	†
Ä	Ö	Ü									

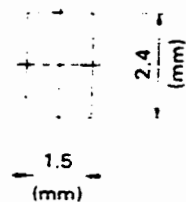

German ASCII 96 ch, Pica 10, print band

Print band specification: B300-2930-T614A

A	B	C	D	E	F	G	H	I	J	K	L
M	N	O	P	Q	R	S	T	U	V	W	X
Y	Z	Ä	Ö	Ü	1	2	3	4	5	6	7
8	9	0	a	b	c	d	e	f	g	h	i
j	k	l	m	n	o	p	q	r	s	t	u
v	w	x	y	z	ä	ö	ü	ß	!	?	-
+	()	%	<	>	/	&	*	=	!	,
;	"	.	:	_	#	\$	^	'	§		

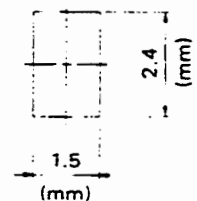

German ASCII 96 ch, OCR-B, print band

Print band specification: B300-2930-T620A

A	B	C	D	E	F	G	H	I	J	K	L
M	N	O	P	Q	R	S	T	U	V	W	X
Y	Z	1	2	3	4	5	6	7	8	9	0
a	b	c	d	e	f	g	h	i	j	k	l
m	n	o	p	q	r	s	t	u	v	w	x
y	z	.	?	(+)	-	"	%	!	!
#	*	>	=	<	/	,	:	&	;	'	'
\$	^	Ä	Ö	Ü	ä	ö	ü	ß	-		

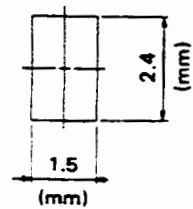

Fresh ASCII print band

Print band specification: B300-2930-T125A (63 characters)
: B300-2930-T126A (94 characters)

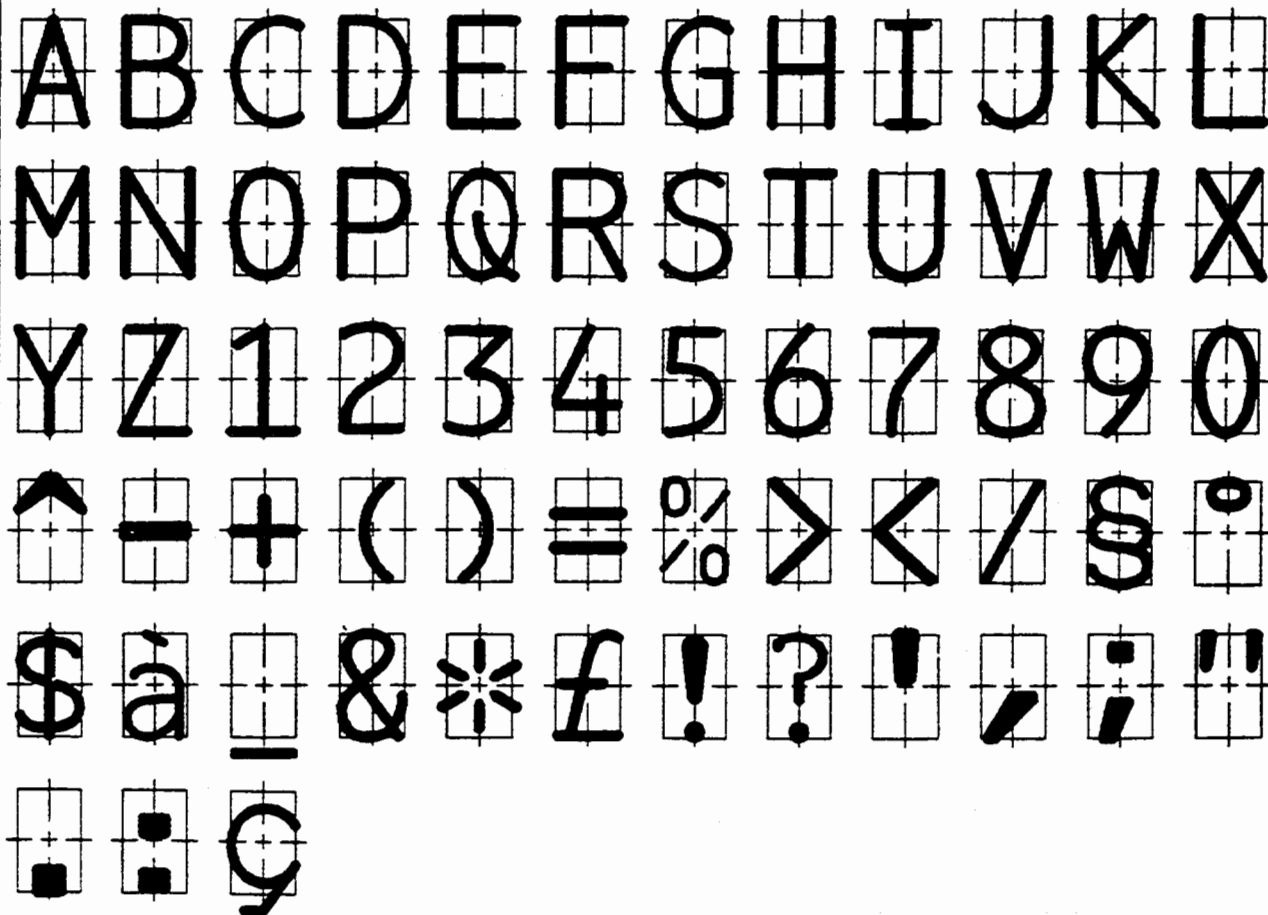

Note: Following characters are provided only for B300-2930-T126A

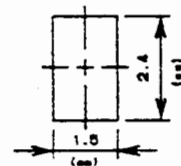
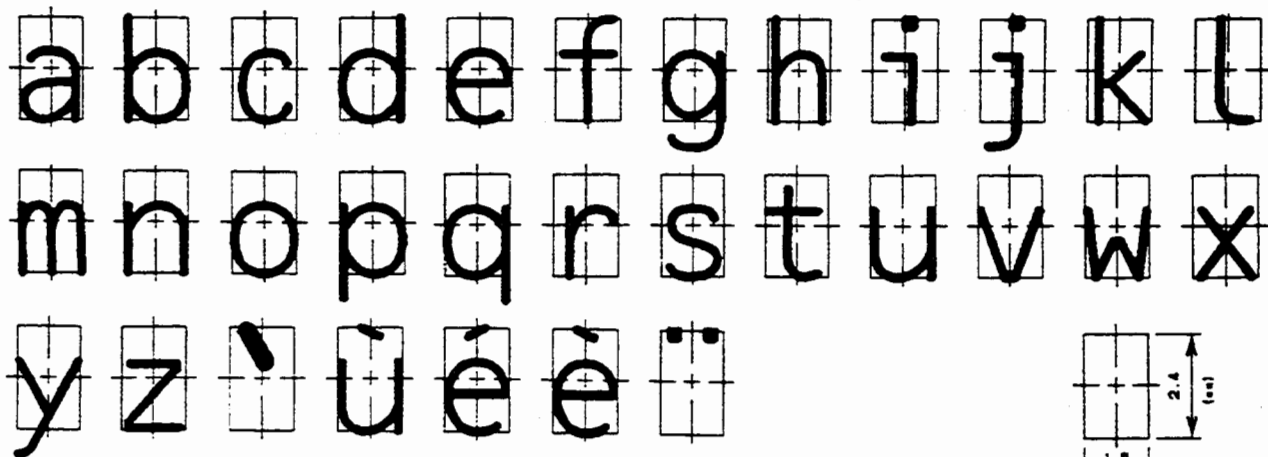

Swedish ASCII print band

Print band specification: B300-2930-T127A (63 characters)
 : B300-2930-T128A (94 characters)

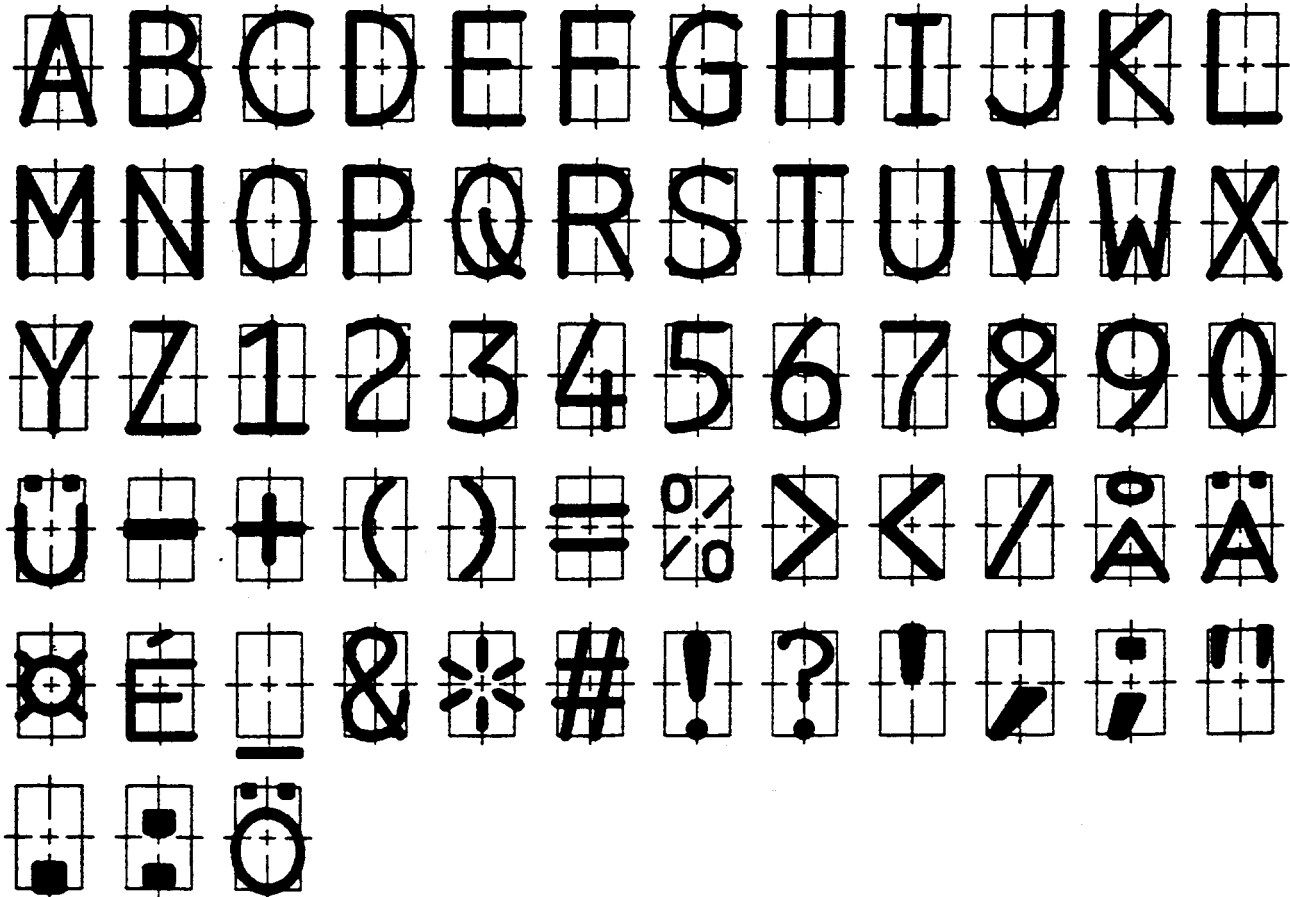

Note: Following characters are provided only for B300-2930-T128A

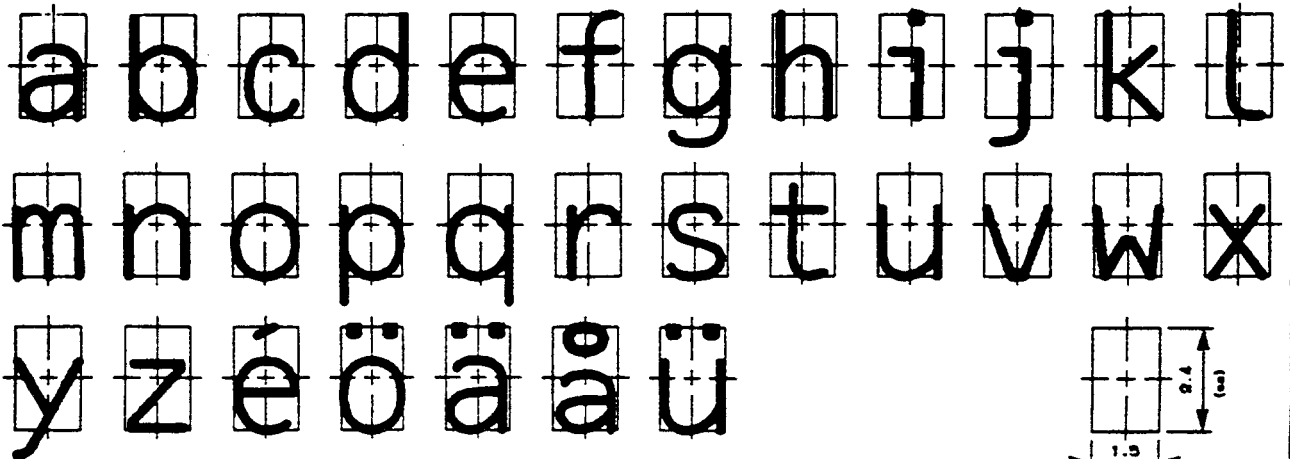

Swedish ASCII 64 ch, OCR-B, print band

Print band specification: B300-2930-T617A

A	B	C	D	E	F	G	H	I	J	K	L
M	N	O	P	Q	R	S	T	U	V	W	X
Y	Z	1	2	3	4	5	6	7	8	9	0
.	?	(+)	-	"	%	!	'	#	*
>	=	<	/	,	:	&	;	_	À	É	Ö
Ü	Å	ä									

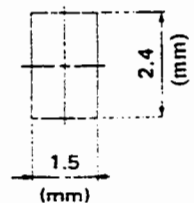

Swedish ASCII 96 ch, OCR-B, print band

Print band specification: B300-2930-T618A

A	B	C	D	E	F	G	H	I	J	K	L
M	N	O	P	Q	R	S	T	U	V	W	X
Y	Z	1	2	3	4	5	6	7	8	9	0
a	b	c	d	e	f	g	h	i	j	k	l
m	n	o	p	q	r	s	t	u	v	w	x
y	z	.	?	(+)	-	"	%	!	!
#	*	>	=	<	/	,	:	&	;	'	À
É	Ö	Ü	Å	ä	é	ö	ü	å	ä	—	

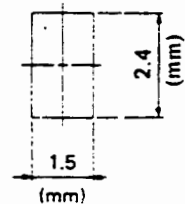

Danish ASCII print band

Print band specification: B300-2930-T129A (63 characters)
: B300-2930-T130A (94 characters)

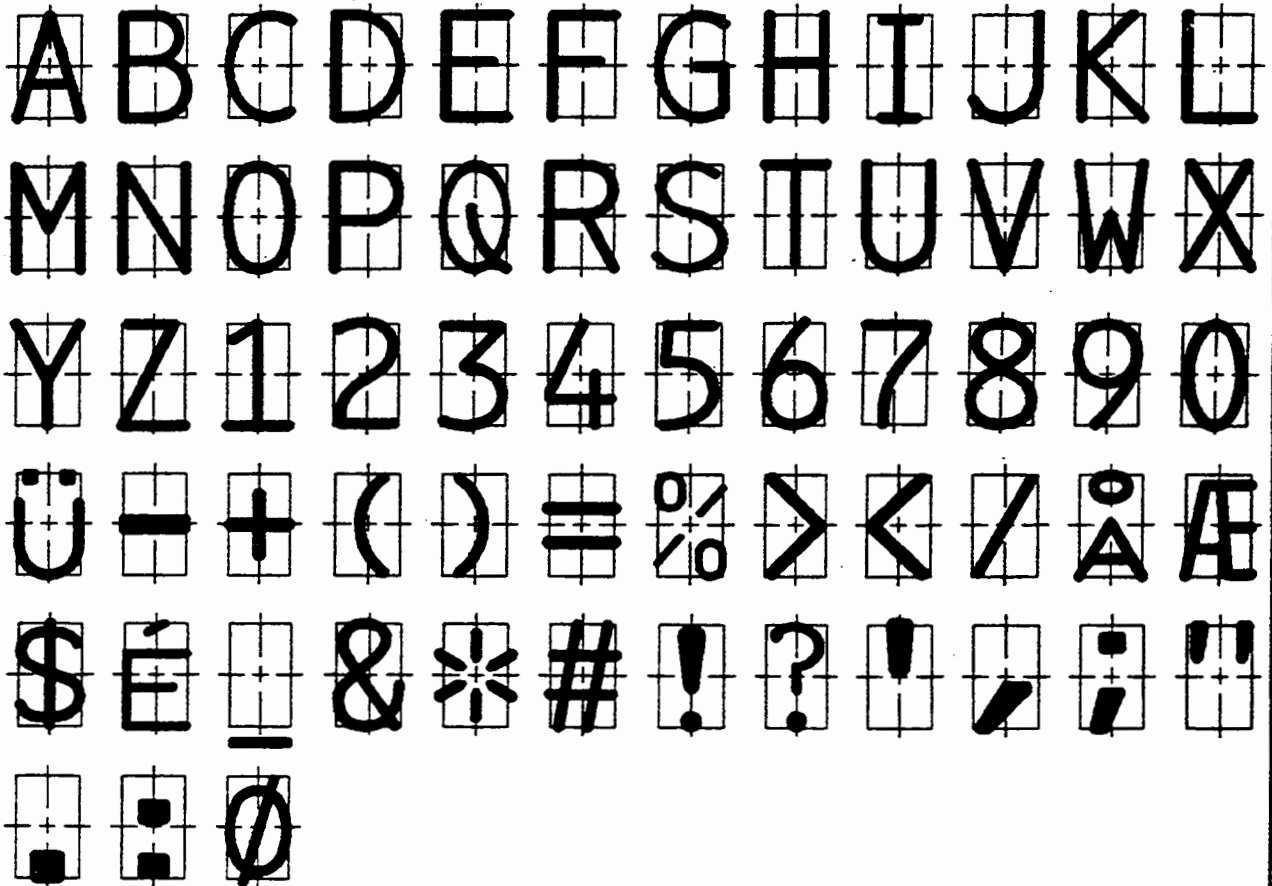

Note: Following characters are provided only for B300-2930-T130A.

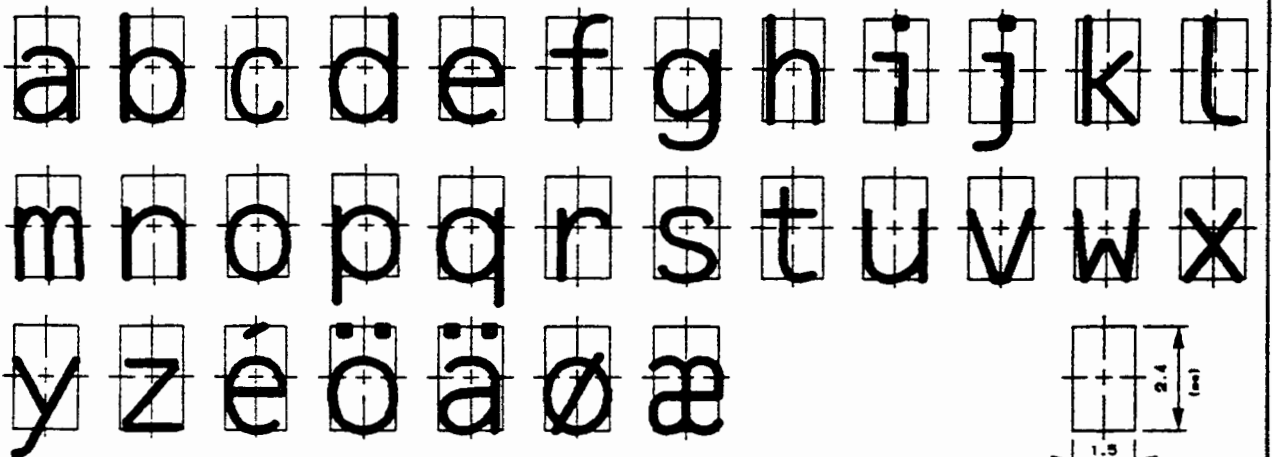



CHAPTER 8 SPECIFICATION LIST

This chapter shows specifications of print bands, options, and expendable supplies.

8.1 Print Bands

Item	Description	Specification		Remarks
		With case	Band only	
1	Print band	B300-2930-T110A	B300-2930-0110A	JIS 64 characters
2	Print band	B300-2930-T111A	B300-2930-0111A	JIS 128 characters
3	Print band	B300-2930-T112A	B300-2930-0112A	USA 64 characters
4	Print band	B300-2930-T113A	B300-2930-0113A	USA 96 characters
5	Print band	B300-2930-T137A	B300-2930-0137A	UK 64 characters
6	Print band	B300-2930-T138A	B300-2930-0138A	UK 96 characters
7	Print band	B300-2930-T123A	B300-2930-0123A	German 64 characters
8	Print band	B300-2930-T124A	B300-2930-0124A	German 96 characters
9	Print band	B300-2930-T125A	B300-2930-0125A	France 64 characters
10	Print band	B300-2930-T126A	B300-2930-0126A	France 96 characters
11	Print band	B300-2930-T127A	B300-2930-0127A	Sweden 64 characters
12	Print band	B300-2930-T128A	B300-2930-0128A	Sweden 96 characters
13	Print band	B300-2930-T129A	B300-2930-0129A	Denmark 64 characters
14	Print band	B300-2930-T130A	B300-2930-0130A	Denmark 96 characters
15	Print band	B300-2930-T601A	B300-2930-0601A	UK 96 characters, OCR-B
16	Print band	B300-2930-T602A	B300-2930-0602A	UK 96 characters, OCR-B
17	Print band	B300-2930-T603A	B300-2930-0603A	UK 64 characters, OCR-B
18	Print band	B300-2930-T604A	B300-2930-0604A	UK 64 characters, OCR-B
19	Print band	B300-2930-T605A	B300-2930-0605A	UK 64 characters, I-font
20	Print band	B300-2930-T606A	B300-2930-0606A	UK 96 characters, I-font
21	Print band	B300-2930-T607A	B300-2930-0607A	UK 64 characters, I-font
22	Print band	B300-2930-T608A	B300-2930-0608A	UK 96 characters, I-font
23	Print band	B300-2930-T609A	B300-2930-0609A	UK 64 characters, Pica 10
24	Print band	B300-2930-T610A	B300-2930-0610A	UK 96 characters, Pica 10
25	Print band	B300-2930-T614A	B300-2930-0614A	German 96 characters, Pica 10
26	Print band	B300-2930-T617A	B300-2930-0617A	Swedish 64 characters, OCR-B
27	Print band	B300-2930-T618A	B300-2930-0618A	Swedish 96 characters, OCR-B
28	Print band	B300-2930-T619A	B300-2930-0619A	German 64 characters, OCR-B
29	Print band	B300-2930-T637A	B300-2930-0637A	US 64 characters, OCR-A
30	Print band	B300-2930-T641A	B300-2930-0641A	German 64 characters, OCR-A

8.2 Options

Item	Description	Specification	Remark
1	Line counter	B02B-1500-0001A	
2	FCT unit (8 ch)	B02B-1500-0002A	Format control tape unit for 8 ch.
3	FCT unit (12 ch)	B02B-1500-0003A	Format control tape unit for 12 ch.
4	Long line interface	B02B-1500-0004A	For DPC or Centronics interface
5	Powered stacker	B02B-1500-0005A	See Note 1
6	Rear panel	B02B-1500-0008A	For forms rack only
7	DPC-AMP type interface connector	B02B-1500-0023A	For M3040D ~ M3042D, see Note 2, 3
8	DPC-AMP type interface connector	B02B-1500-0024A	For M3043D, see Note 2, 3
9	Paper puller	B02B-1500-0061A	For forms rack only

Note 1) This option is only used when the customer, who has the printer with the forms rack, wants the powered stacker.

Note 2) The difference between DPC-AMP type and DPC-WINCHSTER type is only connectors.

Note 3) If these options are selected, the DPC-WINCHESTER type connectors are removed and only the DPC-AMP type connectors are attached.

8.3 Expendable Supplies

Item	Description	Specification	Remark
1	Ribbon cartridge	B87L-0840-0401A #NB02	Real black, long life type
2	Ribbon cartridge	B87L-0840-0402A #NB02	Blue black, long life type
3	8 ch format control tape	B87L-0840-0201A	
4	12 ch format control tape	B87L-0840-0202A	

8.4 Special Tools

Item	Description	Specification	Remark
1	Flight time tester	B02B-1500-0100A	Hammer flight time adjustment tool
2	Seal	B960-0580-V004A	Consumable part for flight time tester



1

2

3

FUJITSU COMPUTER PRODUCTS OF AMERICA, INC.
2904 Orchard Parkway, San Jose, California 95134-2009, U.S.A.
TEL: (408) 432-6333 FAX: (408) 894-1709

© 1994
Printed in U.S.A.