

SHARP

PORTABLE MINIDISC RECORDER

MODEL

MD-MS722H

OPERATION MANUAL

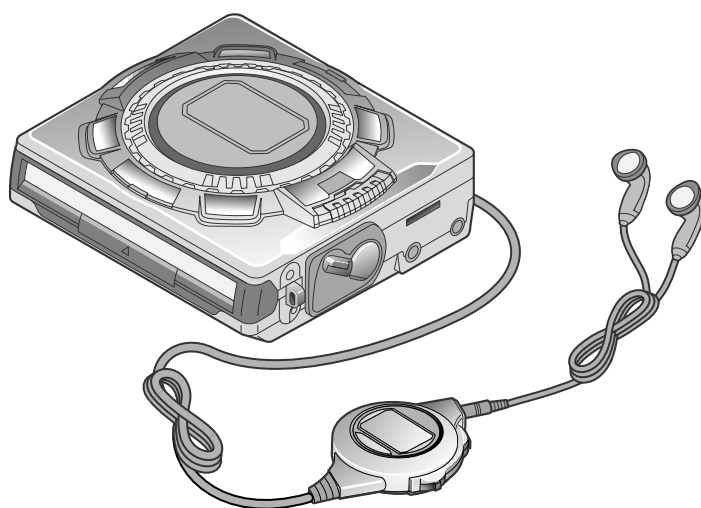

MD-MS722H(SUK)

SPECIAL NOTES

NOTE FOR USERS IN THE U.K.

SERVICE INFORMATION

In the unlikely event of your equipment requiring repair, please contact the dealer or supplier from whom it was purchased. Where this is not possible, please contact the telephone number listed below. You will then be given details of how to obtain service.

– 0345-125387 –

Please note; all calls will be charged at local rate.

Certain replacement parts and accessories may be obtained from our main parts distributor.

WILLOW VALE ELECTRONICS LTD.
MANCHESTER 0161-682-1415
READING 01189-876444

In the unlikely event of this equipment requiring repair during the guarantee period, you will need to provide proof of the date of purchase to the repairing company. Please keep your invoice or receipt, which is supplied at the time of purchase.

- Recording and playback of any material may require consent, which SHARP is unable to give. Please refer particularly to the provisions of the Copyright Act 1956, the Dramatic and Musical Performers Protection Act 1958, the Performers Protection Acts 1963 and 1972 and to any subsequent statutory enactments and orders.
- This equipment complies with the requirements of Directives 89/336/EEC and 73/23/EEC as amended by 93/68/EEC.

WARNING:

THIS AC ADAPTOR SUPPLIED WITH THE MD-MS722H MUST NOT BE USED WITH OTHER EQUIPMENT.

WARNING FOR THE AC ADAPTOR:

THIS UNIT CONTAINS NO USER SERVICEABLE PARTS. NEVER REMOVE THE COVER UNLESS QUALIFIED TO DO SO. THIS UNIT CONTAINS DANGEROUS VOLTAGES. ALWAYS REMOVE MAIN PLUG FROM THE SOCKET BEFORE ANY SERVICE OPERATION AND WHEN NOT IN USE FOR A LONG PERIOD.

CAUTION

Use the portable minidisc recorder only in accordance with the instructions given in this manual and do not attempt to interfere with the interlock switch or make any other adjustment as this may result in exposure to hazardous radiation.

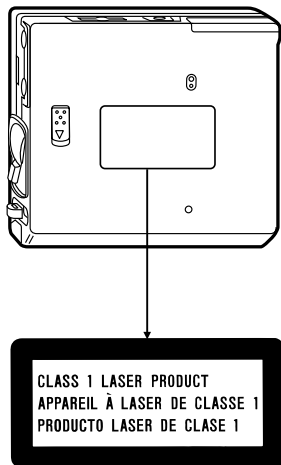

● The letters in brackets contained in the model number indicate the colour of the product only. Operation and specifications are unaffected.

● US and foreign patents licensed from Dolby Laboratories Licensing Corporation.

Warning:

To prevent fire or shock hazard, do not expose this appliance to dripping or splashing.

● The AC adaptor supplied with the MD-MS722H must not be used with other equipment.

Warning:

The supplied AC adaptor contains no user serviceable parts.

Never remove covers unless qualified to do so. It contains dangerous voltages, always remove mains plug from the main outlet socket before any service operation or when not in use for a long period.

CAUTION

At full volume, prolonged listening to a personal stereo may damage the users hearing.

This model complies with the law if used with the correct earphones (model number RPHOH0176AFZZ).

If the earphones are damaged in any way, please order using the model number given above.

INTRODUCTION

Thank you for purchasing this SHARP product.
For the best performance, read this manual carefully.
It will guide you in operating your SHARP product.

CONTENTS

	Page		Page
ACCESSORIES.....	3	ABOUT THE TOC.....	21
PRECAUTIONS.....	4-5	PLAYING A MINIDISC	22-23
NAMES OF CONTROLS AND INDICATORS	5-6	CONVENIENT PLAYBACK FUNCTIONS	24-27
POWER SOURCE.....	7-8	EDITING.....	28-33
BEFORE RECORDING.....	9-10	USING WITH OTHER EQUIPMENT.....	34
RECORDING USING THE ANALOGUE CABLE.....	11-12	CONVENIENT OPERATION OF THE UNIT	35-37
RECORDING USING THE OPTICAL DIGITAL CABLE.....	13	WHAT IS A MINIDISC?.....	38
RECORDING FROM THE MICROPHONE.....	14-15	TROUBLESHOOTING	38-39
CONVENIENT RECORDING FUNCTION	16-19	MINIDISC SYSTEM LIMITATIONS	40
ABOUT TRACK NUMBERS	20	ERROR MESSAGES	41
		MAINTENANCE.....	42
		SPECIFICATIONS	42-43

ACCESSORIES

- Remote Control Unit x 1
- Earphones x 1
- AC Adaptor (RADPA8487AFZZ) x 1
- Rechargeable Lithium-Ion Battery (AD-S31BT) x 1
- Battery Case x 1
- Analogue Cable x 1
- Optical Digital Cable x 1
- Carrying Bag x 1
- Handstrap x 1

Note:

Parts and equipment mentioned in this operation manual other than those detailed above are not included.

■ How to attach the handstrap

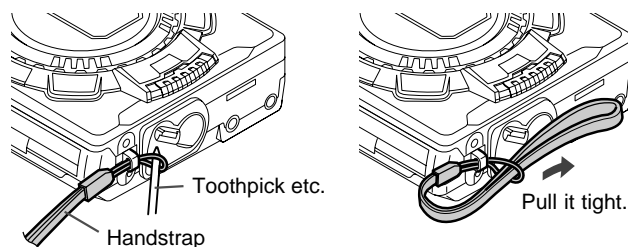

PRECAUTIONS

■ Important

- Do not wear your earphones when you are crossing streets or near traffic.
- Do not use your earphones whilst driving a motor vehicle, it may create a dangerous traffic hazard and may be illegal. Remember to obey all of the safety rules in your area.
- Do not play the unit at a high volume. Hearing experts advise against extended listening at high volume levels.
- If you experience ringing in your ears, reduce the volume or discontinue use.

■ Volume setting

Reduce the volume before starting to play. MiniDiscs, compared to ordinary cassette tapes, have very little noise. If the volume is adjusted according to your usual expectations of noise, you may damage your hearing due to the high volume.

■ Concern for others when listening to MiniDiscs

If you are enjoying listening to music, the sound escaping from your earphones may annoy people around you.

If you are using the unit in particularly crowded places (such as on trains or buses), reduce the volume to avoid annoying people around you.

■ Storing the unit

Avoid using or leaving the unit in the following places.

- Places exposed to direct sunlight for many hours (especially in cars with the doors and windows closed) or near heaters.
(The cabinet may deform, change colour or the unit may malfunction.)
- Places exposed to water.
- Places exposed to excessive dust.
- Places where temperatures are excessively high or low.
- Places (bathrooms) where the humidity is extremely high.
- Places with strong magnetic fields such as TVs or loudspeakers.
- Places exposed to vibration.
- Places where sand can easily enter the inside of the unit (beaches etc.).
- If the unit is used near radio tuners or TVs, noise and/or picture interference may result. If you experience these problems, move the unit away from such devices.

■ Precautions

To avoid accidental electric shock or other possible problems, observe the precautions listed below.

- Do not disassemble or modify the unit.
- Do not drop or subject the unit to shock.
- Do not use the unit near open flames.
- Do not spill liquid on the unit.
- Do not use an external power supply, other than the 5V DC supplied with this unit, as it may damage it.
- SHARP is not responsible for damage due to improper use. Refer all servicing to a SHARP authorised service centre.

■ Notes about the rechargeable battery

- A rechargeable lithium-ion battery is the only kind that can be used. Even if the battery supplied with the unit is not used, you should charge it at least once every three months because of the special quality of this battery.
- The rechargeable battery can be charged approximately 300 times.
- Do not use any battery other than that specified. Use of other batteries may cause malfunctions.
- When the operating time is reduced to about half the normal amount of time, even after a full charge is performed, replace the battery with a new one.
- When charging or when using the rechargeable battery, use it within an ambient temperature range of 5°C to 35°C.
- If the rechargeable battery is used in a cold environment, the operating time will be reduced.

Since the rechargeable battery is vulnerable to damage, please note the following.

- Do not carry the battery in your pocket or a bag together with metal objects (keys, coins, jewelry, etc.). The battery may short out and generate significant amounts of heat.
- Do not short-circuit the terminals as they will become very hot and will damage the battery.
- Do not dip the battery in water, do not dispose of it in a fire, and do not take it apart.

To avoid damaging the battery and shortening its service life, please note the following.

- Do not drop or subject the battery to shock.
- Do not insert objects (metal etc.) into the battery compartment of this product or into the rechargeable battery. Do not get the terminals dirty. If the rechargeable terminals are dirty, the operating time may be shortened or it may not be possible to charge the battery.
- After the rechargeable battery is charged or used, it will get slightly warm. This is normal.

NAMES OF CONTROLS AND INDICATORS

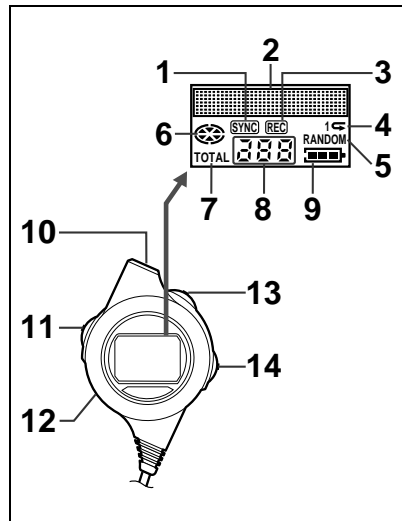

■ Remote control unit

1. Synchro Recording Indicator
2. Character/Time Information Indicator
3. Record Indicator
4. Repeat Indicator:
5. Random Indicator
6. Disc Mode Indicator
7. Total Track Number Display
8. Track Number Indicator
9. Battery Indicator:
10. Earphones Socket
11. Display/Volume Shuttle Switch
12. Hold Switch
13. Play/Pause/Fast Reverse/Fast Forward Shuttle Switch
14. Stop/Power Off/Bass/Play Mode Shuttle Switch

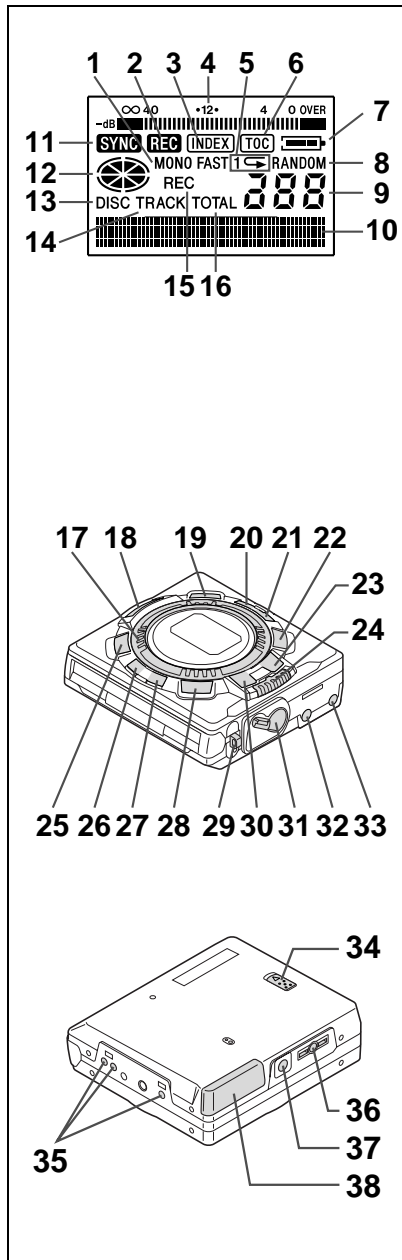

■ Main unit

1. Monaural Long-Play Mode Indicator
2. Record Indicator
3. Index Indicator
4. Level Meter
5. Repeat Indicator:
6. TOC Indicator
7. Battery Indicator:
8. Random Indicator
9. Track Number Indicator
10. Character/Time Information Indicator
11. Synchro Recording Indicator
12. Disc Mode Indicator
13. Disc Name Indicator
14. Track Name Indicator
15. Remaining Recording Time Indicator
16. Total Track Number Display
17. Jog Dial
18. Record/Track Mark Button
19. Volume/Name Select Buttons: -
20. Display/Lowercase Characters Button
21. Character Button
22. Volume/Name Select Buttons: +
23. Play/Pause Button:
24. Fast Reverse/Fast Forward/Recording Level Control/Cursor Shuttle Switch
25. Edit/Auto Mark/Time Mark Button
26. Mode/Insert Button
27. Bass/Delete Button
28. Enter/Fast Play/Synchro Button
29. Handstrap Attachment Eye
30. Stop/Power Off Button: :OFF
31. Eject Lever
32. Optical/Line Input Socket
33. Microphone Input Socket
34. Hold Switch
35. Battery Case Connection Terminals
36. Earphones Socket
37. 5V DC Input Socket
38. Rechargeable Lithium-Ion Battery Compartment

POWER SOURCE

This unit can be used with 4 different power sources: a rechargeable battery, an AC adaptor, a battery case, and a separately available car adaptor (AD-CA20X).

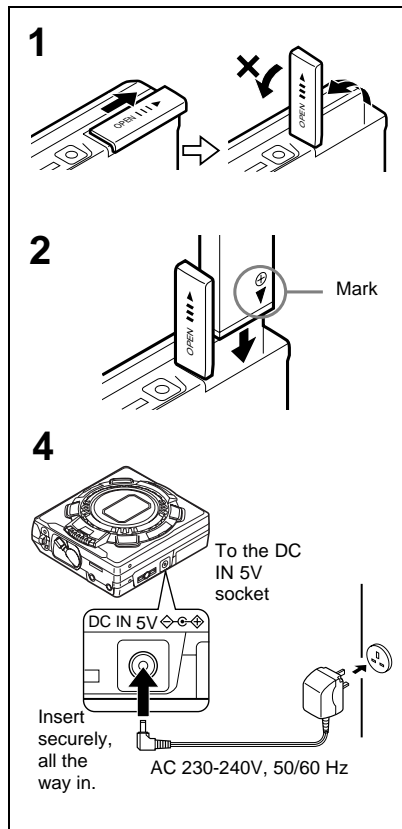

■ Rechargeable battery power

When the rechargeable battery is used for the first time or when you want to use it after a long period of disuse, be sure to charge it fully.

- 1** Open the rechargeable battery compartment cover.
- 2** Insert the rechargeable battery.
 - Insert the side with the arrow first.
- 3** Close the rechargeable battery compartment cover.
- 4** Plug the AC adaptor into the AC socket, and then insert the plug on the AC adaptor lead into the DC IN 5V socket.
 - About 4 seconds later, "⬢" will flash, and the battery will begin charging.
 - Battery charging will be complete in 3.0 hours. When the charging is complete, "⬢" will go out.

Notes:

- After charging has been completed, the AC adaptor may be left connected. (For example, when charging at night)
- If the rechargeable battery is in the unit, it will be charged, even whilst operating the unit. (Float charge)

- Do not force open the rechargeable battery cover too wide.
- When the AC adaptor plug is inserted and a MiniDisc has already been inserted, playback may start automatically. In this case, press the ■ / :OFF button twice to turn the power off.

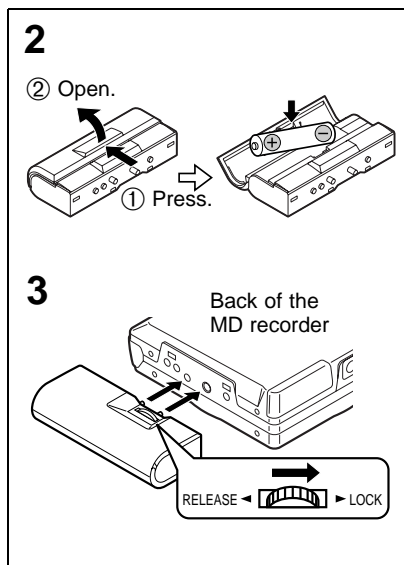

Caution:

- Whilst you are using the rechargeable battery and the alkaline battery at the same time, do not remove either of them. If you do, when the unit is in the play mode, playback will stop. When in the recording mode, the recorded contents will be erased, and the power may be disconnected.
- Do not replace the battery or the rechargeable battery during operation.
- Do not use rechargeable batteries (nickel-cadmium battery etc.) in the battery case.
- If the unit is not used for a long period of time, remove the battery. (Even if the power is turned off, the battery will be drained slowly but continuously.)
- Be sure to hold the plug when removing it. If you pull on the lead, it may break, or the unit may malfunction.
- Do not use any car adaptor except for the separately available AD-CA20X.
- For information about the battery life, see the battery item in the SPECIFICATIONS on page 42.
- This unit should only be used within the range of 0°C and 40°C.

■ Alkaline battery power

If you use the battery case and the rechargeable battery at the same time, the MD can play much longer than with only one source of battery power.

- Use one commercially available alkaline battery (LR6, "AA" size).

- 1 Make sure that a fully charged rechargeable battery is inserted.
- Do not use the unit if it only has an alkaline battery in it.
- 2 Insert the battery into the battery case.
 - (1) Open the case cover.
 - (2) Insert the battery according to the polarity marked on the inside of the battery case. Then, close the case cover.
- 3 Attach the battery case to the main unit.
 - (1) Match the convex part of the battery case to the concave area in the main unit.
 - (2) Turn the screw in the direction marked "LOCK" to secure the battery case.

■ AC power

- 1 Connect the lead from the AC adaptor to the DC IN 5V socket on the main unit.
- 2 Plug the AC adaptor into an AC socket.

Notes:

- When there is thunder or lightning in your vicinity, unplug the AC adaptor from the AC socket.
- When the unit is not in use for extended periods, remove the AC adaptor from the AC socket.
- Never use an AC adaptor other than the one specified. Otherwise, problems or serious hazards may be created.
- Do not bend, twist or tie the power lead or put heavy objects on top of it.

BEFORE RECORDING

■ Type of recording

Two types of recording are possible: "Digital recording" and "Analogue recording". There are different cables and connections for each type of recording, depending on the sockets on the equipment being connected to the unit.

(1) Analogue recording

Connect the unit to equipment that has a line output socket, using the analogue cable included with this unit.

- Main equipment: CD player, MD player, radio cassette player, etc.
- Cable required: Analogue cable included with this unit

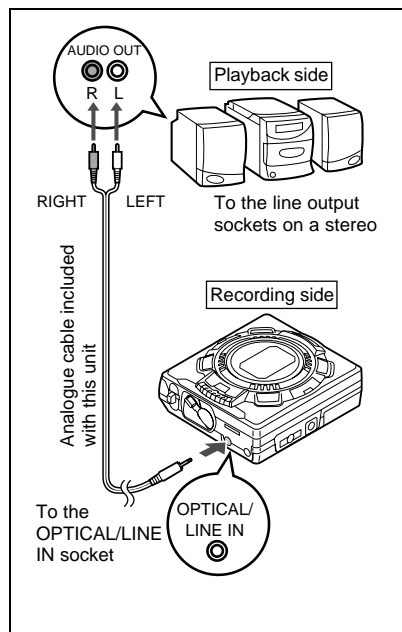

(2) Digital recording

Connect the unit to equipment that has an optical output socket using the optical digital cable included with this unit. Using an optical signal to transfer the music to a MiniDisc allows very high quality recording.

- Main equipment: CS/BS tuner, CD player, MD player, etc.
- Cable required: Optical digital cable (Optical digital cable included with the unit or optional optical digital cable AD-M2DC)

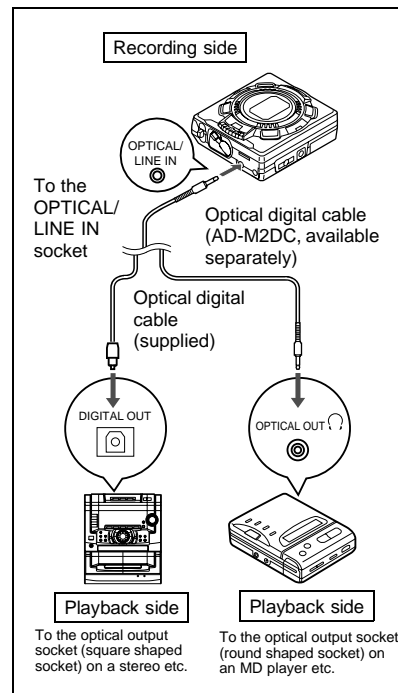

■ Types of discs

There are two types of discs: playback-only and recordable discs.

● Playback-only MiniDisc:

This type of MiniDisc usually contains commercially available pre-recorded music. This is the same kind of optical disc as CDs. Playback is performed using an optical pickup.
(Recording and editing are not possible.)

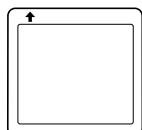

There will only be a shutter on one side (the back).

● Recordable MiniDisc:

This is a "raw disc" on which recording can be performed. This is a magneto-optical disc. Recordings are made using a laser and a modulated magnetic field. Repeated recording is possible.

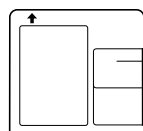

Shutters can be seen on both sides of this type of disc.

■ To prevent recorded discs from being erased accidentally

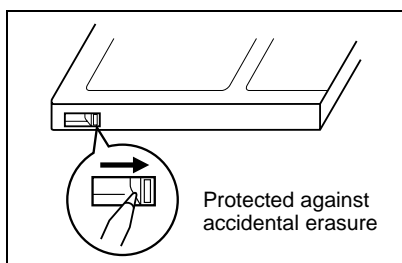

Slide the accidental erase prevention tab, located on the side of the disc, in the direction indicated by the arrow.

- The disc will then be protected against accidental erasure.
- To add a recording to such a disc, slide the accidental erase prevention tab back to its original position.

Notes:

- When making important recordings, it is recommended that you use the AC adaptor. A fully charged rechargeable battery should be loaded into the unit. Then, even if a power failure occurs, the power source will switch over to the rechargeable battery automatically.
- When using the rechargeable battery or the alkaline battery, if the headphones volume level is set to "0", the

battery consumption will be less than when listening to the recording whilst it is being made.

- Insert each plug firmly. If the connections are poor, the recording may not be made properly. Always keep the plugs clean. If the plugs are dirty, electrical noise may be recorded.

RECORDING USING THE ANALOGUE CABLE

■ Recording from CDs or MDs (Synchro recording)

- Synchro recording is a method that detects the playback sound from the source equipment. When sound is present, it automatically starts the recording. When the source is silent, the recording will be paused.

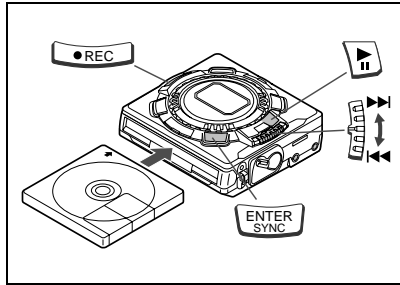

1 Connect the external equipment.
(See page 9.)

2 Insert a recordable MiniDisc.

3 Press the ● REC button.

- To record from a tuner, first tune in a broadcast.
- To record from a CD, first start playing the track you want to record.

4 Whilst playing sound from external equipment connected to this unit, move the shuttle switch up or down to adjust the recording level.

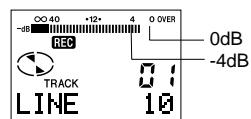

- Adjust the recording level so that the maximum sound volume from the source makes the reading swing somewhere between -4 dB and 0 dB.
- To record from a CD, first adjust the recording level. Then put the equipment connected to this unit into the playback stand-by mode.

5 Press the ENTER/SYNC button.

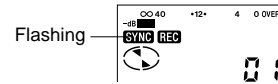

6 Begin playback on the source equipment.

- Recording will begin automatically.

To interrupt recording:

- When the source equipment is stopped, the unit will enter the synchro recording stand-by mode. When playback is resumed, a recording will be resumed.
- If a silence lasts for 3 seconds or more, the recording will be paused.
- Pressing the ►|| button on this unit (when in this mode) will cause the unit to enter the recording stand-by mode and cancel the synchro recording mode.

To stop recording:

Press the ■/OFF button.

- If the unit is left alone after the recording has stopped, the power will be turned off about 2 minutes later.

After recording:

Press the ■/OFF button whilst in the stop mode.

- After the track number has been written on the disc, the power will be turned off

automatically. (For details about the TOC, see page 21.)

To remove the MiniDisc:

Turn off the power and move the EJECT lever in the direction indicated by the arrow.

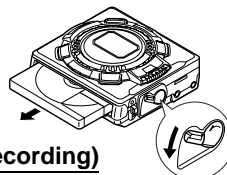
**■ Recording from a tuner or a CD (Manual recording)**

- Manual recordings can be started and stopped as you like.

1 Put the unit in the recording stand-by mode. (Perform steps 1 - 4 in the "Synchro recording" section.)

2 Press the ►|| button.

- Recording will start.
- To record from a CD, press the ►|| button, and then start playback on the equipment connected to this unit.
- Track numbers can be created whilst recording. (Page 18)

To interrupt recording:

Press the ►|| button whilst recording.

- The unit will enter the recording stand-by mode.
- To resume recording, press the ►|| button again. The track number will be increased by one each time you interrupt a recording.

Recordings can not be made in the following situations:

- Recording on a playback-only MiniDisc (commercially available music)
- If a Minidisc is protected against accidental erasure (page 10)

About the recording level:

- If the recording level is too low, the playback sound volume may be too low to hear well. If it is too high, the playback sound may be greatly distorted. Since digitally recorded CDs have a large dynamic range (the volume can vary tremendously from very soft to extremely loud), do not set the recording level any higher than is necessary.

Precautions when recording:

- Do not jar or bump the main unit whilst recording. Otherwise, the recording may be unusable.

- Depending on the strength and type of playback signal in the original recording, the new recording may not begin or pause at the correct point when in the synchro mode. If this happens, try making a manual recording.

Precautions when inserting a MiniDisc:

- To insert a Minidisc, push on the middle of the edge of the disc whilst holding it parallel to the main unit.
- If any resistance is felt, do not try to force the MiniDisc into the unit. It may cause more problems. If resistance is felt, remove the MiniDisc and try reloading it.

Note:

- Whenever any button is pressed, the remote control display will light for about 7 seconds.

RECORDING USING THE OPTICAL DIGITAL CABLE

This is the method of recording digital signals from CDs or MDs exactly as they are stored on the original. Compared to recordings made from analogue inputs, digital recordings have extremely high-quality sound.

1 Connect the external equipment.
(See page 9.)

2 Start recording.
Synchro recording: Page 11

Before starting a synchro recording, perform the following steps on the equipment connected to this unit.

- (1) First, put it in the playback mode.
- (2) Next, put it in the pause mode.
- (3) Finally, position it at the beginning of the track you want to record.

- (1) Insert a recordable MiniDisc, and then press the ● REC button.
- (2) Press the ENTER/SYNC button.
- (3) Start the playback on the equipment connected to this unit.

Manual recording: Page 12

- (1) Insert a recordable MiniDisc, and then press the ● REC button.
- (2) Press the ►|| button.

- When recording from digital inputs, it is not necessary to adjust the recording level.

There are cases where digital recording may be impossible.

In the following cases digital recording is impossible, even if you are using digital cables.

When you attempt to make a new digital recording from a track that was digitally recorded on a MiniDisc

- MiniDiscs are designed so that only first generation digital copies can be made, further digital copies are prevented by the SCMS (Serial Copy Management System).

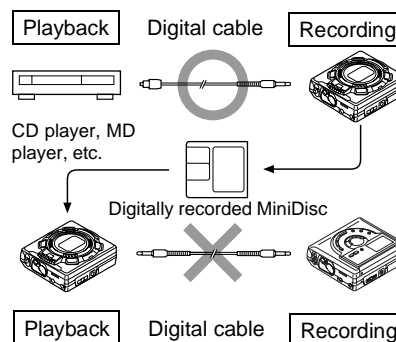

Analogue recording is possible.

Notes:

- This unit incorporates a sampling rate converter. When this unit is connected to digital equipment such as CS/BS tuners or DAT tape recorders that use a different sampling frequency (32 kHz or 48 kHz), recordings can still be made. (The sampling frequency of this unit is 44.1 kHz.)
- When recording from a portable CD player, if it has a dropout prevention function, turn that feature off.

RECORDING FROM THE MICROPHONE

■ Recording from the microphone (Mic synchro recording)

The recording will begin automatically in response to a noise or a person speaking. When the sound stops, the recording will pause. This function is convenient when recording lectures, conferences, etc.

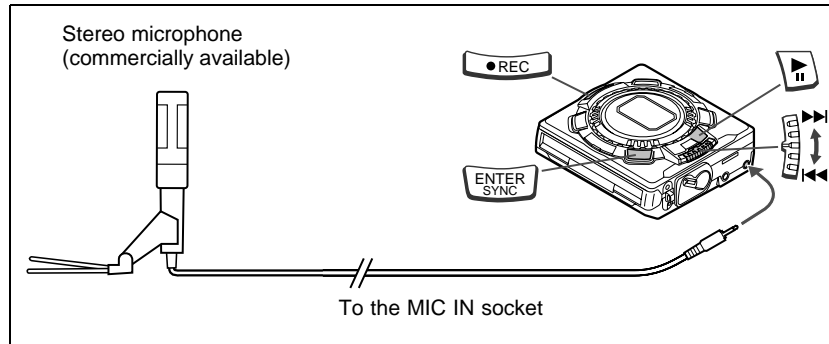

- 1 Connect the stereo microphone to the MIC IN socket on the main unit.
 - When a microphone is connected to this unit, the unit will automatically switch to input from the microphone.
- 2 Insert a recordable Minidisc.
- 3 Press the ● REC button.
 - A monaural, long-play recording mode is available. (Page 18)
 - Timed identification marks can be created whilst recording. (Page 16)
- 4 Move the shuttle switch up or down to adjust the recording level.
- 5 Press the ENTER/SYNC button to select the synchro recording level. (This level can be changed, even whilst recording.)
 - Refer to the following table.

	Synchro recording level display	Sound level at which to start recording
Mic input	MIC SYNC H	-24dB
	MIC SYNC L	-12dB

- When the microphone input is set to MIC SYNC H, recording will start when the smallest noise is detected. If the unit starts recording too often from small unwanted noises, set the microphone input to MIC SYNC L.

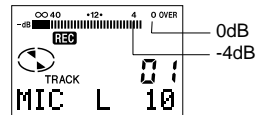

- Adjust the recording level so that the maximum sound volume from the source makes the reading swing between -4 dB and 0 dB.
- When the recording level display is changed from "MIC H" to "MIC L", the sound will be interrupted momentarily. This is normal.

6 When a noise, such as a person speaking, is picked up by the microphone, recording will begin automatically.

- If a silence lasts for 3 seconds or more, the recording will be paused automatically. However, the unit will not pause for about the first 10 seconds after recording has started.

To interrupt a synchro recording:

Press the ►|| button whilst recording.

- The Mic synchro recording mode will be cancelled, and the unit will enter the recording stand-by mode.
- To resume synchro recording, press the ENTER/SYNC button again.

To stop recording:

Press the ■/:OFF button.

**■ Recording from the microphone
(Mic manual recording)**

- You can start recording manually (any time you like).

1 Put the unit in the recording stand-by mode. (Perform steps 1 - 4 in the "Mic synchro recording" section.)

2 Press the ►|| button.
● Recording will start.

To interrupt a recording:

Press the ►|| button whilst recording.

- The unit will enter the recording stand-by mode.
- To resume recording, press the ►|| button again.

The track number will be increased by one each time you interrupt a recording.

To stop recording:

Press the ■/:OFF button.

Notes:

- If you want to use a microphone, be sure it is a plug-in-power type microphone.
 - When a plug-in-power type microphone is plugged in, the main unit will provide power for the microphone's operation.
 - If a different type of microphone is plugged in, it may not operate properly or it may cause the unit to malfunction.
- Insert the plug firmly. If you don't, the recording will not be made properly.
- Use a microphone with a 3.5 mm (1/8") diameter stereo mini plug.
- When a recording is made using a stereo microphone (available separately), an analogue recording will be made.
- Whilst making a mic recording, do not connect anything to the LINE IN socket on the main unit.

CONVENIENT RECORDING FUNCTION

■ Creating marks whilst making a mic recording (Timed auto mark function)

Marks can be created at a fixed interval (every 5 minutes is the default setting) so that the beginning of any track can be found. The interval at which marks are created can be changed by the user.

Whilst in the recording stand-by mode or whilst recording, press the EDIT/MARK button.

- Each time the button is pressed, the setting will change as follows:

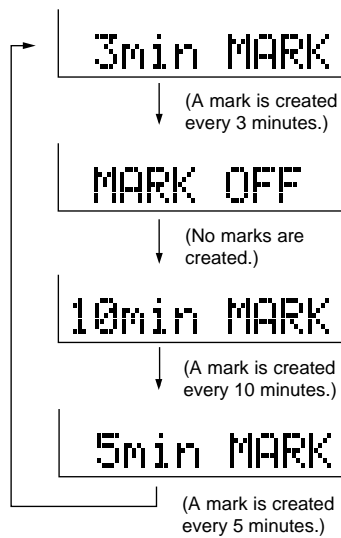

- The time between marks may vary slightly when compared with the actual recording time.

About the timed auto mark:

Whenever a recording begins, a track number will be created automatically.

- : Track number which is created when a silence lasts for 3 seconds or more during synchro recording.
- : Track number which is created by the timed auto mark function.

Example when the setting is for “5 minutes”:

When making a mic synchro recording

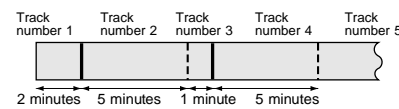

If a silence lasts for 3 seconds or more, a timed auto mark will be created 5 minutes after the previously created track number.

When making a mic manual recording

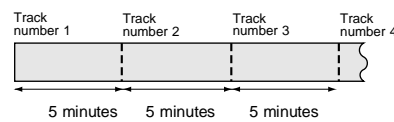

- A timed auto mark will be created every 5 minutes.

When the timed auto mark setting has been changed

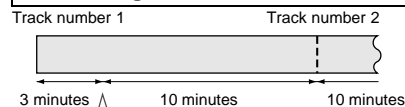

When the setting is changed to 10 minutes whilst recording, a timed auto mark will be created 10 minutes after the change is made.

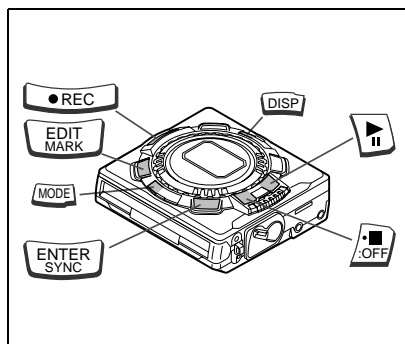

■ Recording tracks as a single track

You can record several pieces of music as a single track, disable the auto marker function.

- 1 Press the EDIT/MARK button whilst the recording is paused.

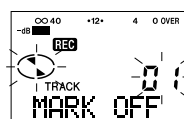

(The display will be blanked out immediately.)

- 2 Press the ►|| button.
 - Recording will start.

Note:

- When making digital recordings using a CD player or an MD player, track numbers will be created automatically regardless of the setting of the auto marker function.

Making a track number automatically:

Press the EDIT/MARK button whilst the recording is paused.

- "AUTO MARK" will be displayed.

■ To start recording from the middle of an existing track

You can erase a portion of a track that has been already recorded and make a new recording.

Warning:

- All of the tracks that follow the newly recorded track will be erased.

- 1 During playback, press the ►|| button at the point where you want to begin re-recording.

- 2 Press the ● REC button.

- To cancel the operation, press the ■/OFF button.

- 3 Press the ENTER/SYNC button.

- All of the tracks and track names will be erased, following the point where the playback is paused.

2

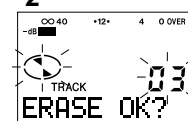

3

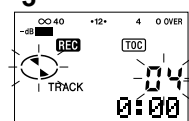

Number of the track to be recorded next

- 4 Press the ►|| button.

- Recording will start.

Note:

- When there is a track that you don't want to erase after the point on the disc where you want to make a new recording, use the move function to move the track and then make your recording after that point. (See "EDITING", page 28.)

■ To check the remaining disc time

Whilst recording, you can check the remaining time available on the disc.

Press the DISP button on the main unit or the DISPLAY button on the remote control unit whilst recording or whilst in the recording pause mode.

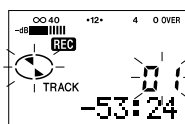

Remaining recordable time

- When the DISP button on the main unit or the DISPLAY button on the remote control unit is pressed again, the unit will return to the initial display.

Note:

- The display of the remaining disc time may vary slightly from the actual remaining time. (Page 40)

■ To create your own track numbers whilst recording

You can create your own track numbers at special points in a recording, so that these points can easily be found later.

At any point where you want to create a track number whilst recording, press the

- REC button on the main unit or move the shuttle switch on the lower right of the remote control unit up.
- The track number will be written on the disc and the recording will continue uninterrupted.

■ Double time recording in monaural mode

When recording in the monaural long-play mode, it can be about twice as long as the recording time available for a stereo recording. The monaural long-play mode is very useful for recording conferences or lectures.

Press the MODE button whilst the recording is paused.

- Each time this button is pressed, the display will switch between the stereo mode and the monaural long-play mode.

Lights up whilst in the monaural long-play mode.

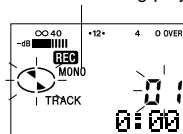

Notes:

- If input is from a stereo source, the sounds from the left and right channels will be combined.
- Although the monitor sound you hear in the earphones whilst recording is in stereo, recording will be monaural.
- MiniDiscs recorded in the monaural long-play mode may not be playable on other MD players.
- When a recording is made in the monaural long-play mode, you will be able to play back the MiniDisc twice as fast as the normal playback speed. (Page 25)
- When the unit is stopped after a recording has been made in the monaural long-play mode, the recording mode will return to the stereo mode automatically.

■ **To erase tracks**

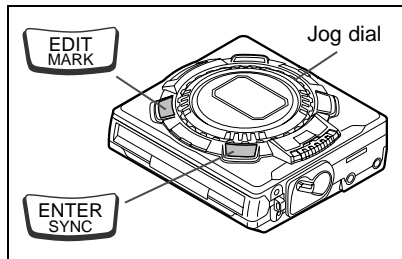

To erase tracks one at a time:

- 1** Start playing the track you want to erase, and press the **▶||** button.
 - The unit will enter the pause mode.
- 2** Press the **EDIT/MARK** button and turn the jog dial to select "ERASE".

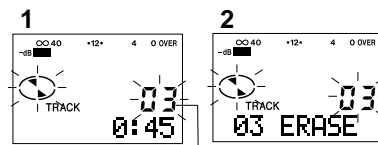

Number of the paused track

- 3** Press the **ENTER/SYNC** button.
 - To cancel the operation, press the **■/OFF** button.
- 4** Press the **ENTER/SYNC** button again.
 - The track will be erased.

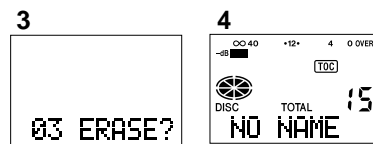

- 5** To erase other tracks, repeat steps 1 - 4.

To erase all of the tracks at once:

- 1** Whilst in the stop mode, press the **EDIT/MARK** button and turn the jog dial to select "ALL ERASE".
 - "ALL ERASE" can also be selected by holding down the **EDIT/MARK** button for at least 2 seconds.
- 2** Press the **ENTER/SYNC** button.
 - To cancel the operation, press the **■/OFF** button.

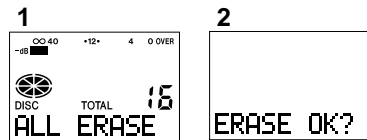

- 3** Press the **ENTER/SYNC** button again.
 - All of the track numbers, track names, and disc names will be erased.



Notes:

- Once a track has been erased, it cannot be recovered. Double-check the track number before erasing it.
- When a track is erased, the numbers assigned to the tracks following the erased track will be automatically decreased by one.
- When a track is erased, the track name will be erased at the same time.

ABOUT TRACK NUMBERS

When recording, track numbers will be created automatically.
(Auto marker function/Synchro marker function)

When recording from analogue inputs: (Including digital inputs other than CDs or MiniDiscs)

A new track number will be automatically created whenever 1 second or more of silence occurs in the source.
(Auto marker function)

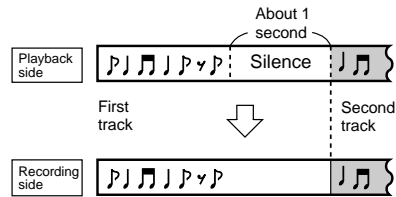

- If there is some noise in the “silent” spaces from the source, the track numbers may not be created at the correct position, depending on the contents of the source being recorded.
- You can also record a series of tracks without using the auto marker function.

When recording from digital inputs: (CDs/MiniDiscs only)

Track numbers will be created automatically for each track at the same point where track numbers already exist on the CD or MiniDisc.
(Synchro marker function)

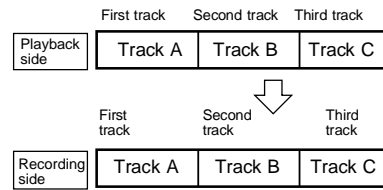

- The track numbers on the playback side may not match the track numbers recorded on the MiniDisc.
- When recording, if a programmed playback is performed by the source or playback is performed by selecting tracks manually, the MiniDisc track numbers may not be the same as on the source.
- The track numbers can also be changed after recording.
- Track numbers may not be created, even when recording from digital inputs, depending on the CD player used for the source.

ABOUT THE TOC

The TOC (an abbreviation for Table of Contents) is information about the track numbers and recorded areas that allow the unit to find musical selections or sounds. The entire MD is controlled by the information in this TOC, which enables the unit to find the beginning of a track quickly or to record automatically in a vacant area.

- The TOC is recorded in a specific area on a MiniDisc, which is not used for sound recording.

■ About TOC recording

When you start recording or editing, "TOC" will appear in the display.

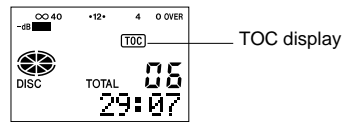

This indicates that information in the TOC is now being changed according to recording or editing being performed.

- **The changed TOC information will not be recorded on the MiniDisc right away.**

Notes:

- Whilst "TOC" is displayed, the MiniDisc should not be removed. Turn the power off first, and then remove the MiniDisc.
- The edited contents can be stored on the disc after several editing steps have been performed.

■ When is the TOC recorded?

The revised TOC will be recorded on the disc automatically when you press the **■**/OFF button whilst in the stop mode. This will also turn the power to this unit off.

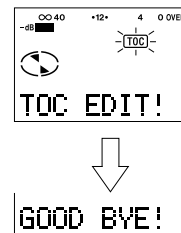

The power will be turned off after the TOC has been recorded on the disc.

Caution:

- Whilst "TOC" or "TOC EDIT!" is displayed, do not do any of the following.
 - Do not jar or bump the main unit.
 - Do not unplug the AC adaptor.
 - Do not remove the rechargeable battery or battery case.

If you do, the changes in the recorded or edited contents will be lost if the TOC information is not recorded properly.

- If the AC adaptor is unplugged or a power failure occurs whilst recording (before the TOC information has been written on the disc), the new recording will be erased.

When a new recording is added to a MiniDisc in a position where TOC information already exists, the added recording will be erased.

PLAYING A MINIDISC

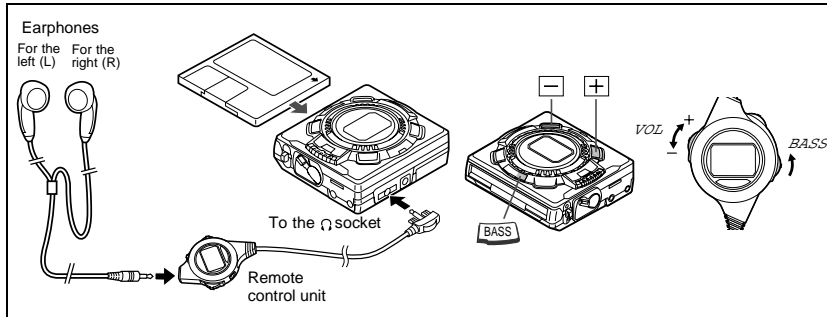

- 1 Insert the earphones plug firmly into the earphones socket on the remote control unit.
- 2 Plug the remote control unit into the Ⓞ socket on the main unit. Push the plug all the way in.
 - Since the remote control unit plug has only one correct orientation, plug it in as shown in the drawing.
- 3 Load a MiniDisc in the direction indicated by the arrow on the MiniDisc, with the label side facing up. (Insert the MiniDisc firmly, until a click is heard.)
 - The power will be turned on automatically, and playback will start from the first track. (Auto-play function)

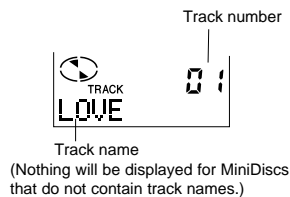

- After playback of the last track has finished, the unit will stop automatically.

Playback does not start when a MiniDisc is inserted:

Press the ►|| button.
In the following cases, the auto-play function will not work.

- When the recordable MiniDisc write protection tab is closed (page 10)
- When the auto-play function has been cancelled (page 37)

4 From the main unit:

Press the + button to increase the volume and the - button to decrease the volume.

From the remote control unit:

Move the shuttle switch up once to increase the volume, and move it down once to decrease the volume.



Volume (0 - 30)

5 Adjust the bass level.

Each time the BASS button is pressed, the tone will be switched as follows:



- BASS 1 — Bass sounds are emphasised slightly.
- BASS 2 — Bass sounds are emphasised more.
- BASS 3 — Bass sounds are emphasised even more.
- BASS OFF — Bass emphasis is cancelled.

- When recording, it is impossible to adjust the bass level (Bass emphasis is cancelled).
- The most recent volume or bass settings are saved when the power is turned off.

To interrupt playback:

Press the ►|| button during playback.

- To resume playback, press the ►|| button again.

To stop playback:

Press the ■/OFF button.

- When you press the ►|| button to resume playback, it will start at the point on the disc where playback was halted (Resume function). However, if the MiniDisc is removed and reinserted, playback will start from the first track.

To turn off the power:

Press the ■/OFF button whilst in the stop mode.

- If the unit is not operated for at least 2 minutes whilst in the stop mode, the power will be turned off automatically.

To remove the MiniDisc:

Turn off the power and move the EJECT lever in the direction indicated by the arrow.

Precautions when making connections:

- Do not use any remote control unit, except for the one included with this unit.
- Do not remove the rubber pads from the earphones.
- Insert each plug securely, all the way in.
- Be sure to hold the plug when removing it. If you pull on the lead, it may break, or the unit may malfunction.

Interrupted sound:

- This product is designed to eliminate interruptions in the sound which can be caused by vibrations. However, if the unit is continuously exposed to vibrations or mechanical shock, the sound may be interrupted momentarily.

When the sound is distorted:

- If the volume is too high whilst the bass is being emphasised, the sound may be distorted, depending on the music on the track. If this happens, decrease the bass level or lower the volume level.
- If the volume is increased to "VOL 26" or higher, the bass level will be adjusted automatically. (This is done to reduce the distortion in the sound.)

Caution:

- When the unit is not to be used immediately after a MiniDisc has been inserted, or when you plan to carry the unit, turn off the power or cancel the auto-play function. Otherwise, the auto-play function will be activated and the battery will run down.
- Since the main unit and the AC adaptor can heat up during use, you should avoid allowing the unit to be in direct contact with your skin for any length of time.

When using the unit with a car adaptor:

- When you switch off the ignition key during playback, the power to this unit will also be turned off. Then, when the ignition key is switched on, playback will start from the beginning of the track where playback was halted (Resume auto-play function). However, the power to the unit may not be turned off when the ignition is turned off, depending on the type of car.

CONVENIENT PLAYBACK FUNCTIONS

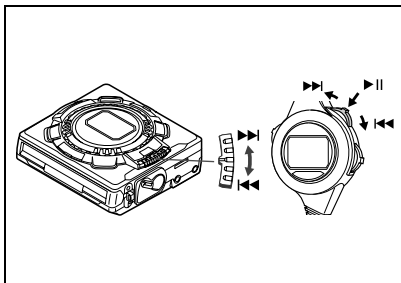

■ APSS (Auto Program Search System)

APSS automatically locates the beginning of any track.

To move to the beginning of the next track:

Move the shuttle switch up once during playback.

To re-start the track being played:

Move the shuttle switch down once during playback.

To skip a number of tracks at one time, move the shuttle switch up or down repeatedly until the desired track number is shown.

To begin playback at a desired track, move the shuttle switch up or down repeatedly whilst in the stop mode to select the track number. Then, press the ►|| button.

Note:

- If the first track on the disc is currently selected and the shuttle switch is moved down, the last track on the disc will be located. When the last track is currently selected and the shuttle switch is moved up, the first track will be located.

■ Cue and review

- 1 Load a MiniDisc and begin playback.
- 2 Move the shuttle switch up and hold it there for audible fast forward. Or, move the shuttle switch down and hold it there for audible fast reverse.
- 3 Normal playback will resume when the shuttle switch is released.

Notes:

- When the end of the last track is reached during fast forward, the unit will enter the pause mode. When the beginning of the first track is reached during fast reverse, the unit will enter the playback mode.
- When the unit is in the all track repeat mode, the search will wrap around from the last track to the first, or vice versa.
- Depending on the contents recorded on a MiniDisc, some sounds may be skipped whilst cueing and reviewing.

To search very quickly:

When fast forward or fast reverse is used whilst in the pause mode, the search will be performed more quickly than during audible fast forward or fast reverse playback.

- In this mode, no sound is heard. Therefore, you should refer to the time display.
- When you lift your finger, the unit will re-enter the pause mode.

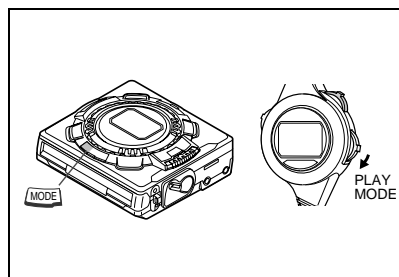
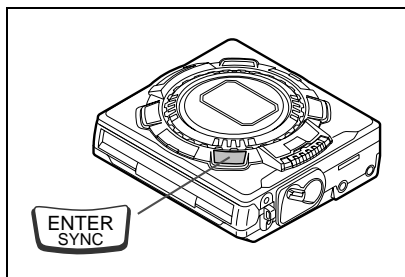

**■ To play at double speed
(Mono recording only)**

Press the ENTER/SYNC button whilst a MiniDisc recorded in the monaural long-play mode is being played.

- The unit will display "FAST PLAY" and start fast playback.

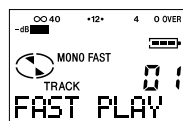

- When the ENTER/SYNC button is pressed again, the unit will return to normal play.

Notes:

- Depending on the contents recorded on a MiniDisc, it may be difficult to hear them.
- If a track recorded in the stereo mode is reached during fast playback, the fast playback mode will be cancelled.
- To reenter the fast playback mode, press the ENTER/SYNC button.

To interrupt fast playback:

Press the ►|| button during playback.

- When the ►|| button is pressed again, the unit will resume fast playback.

■ Random play or repeat play

During playback or whilst in the stop mode, press the MODE button on the main unit repeatedly, or move the shuttle switch on the lower right of the remote control unit down to select the playback mode.

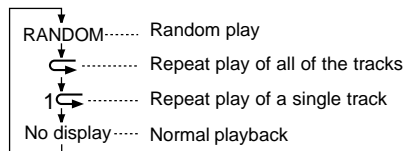

- If the playback mode is selected whilst stopped, press the ►|| button to start playback.

Notes:

- When "TOC" is displayed, repeat play is impossible.
- In random play the unit will select and play tracks automatically. (You cannot select the order of the tracks.)
After all of the tracks have been played once each in random order, the unit will stop automatically.
- During random play or repeat play of a single track, cue and review of the previous or next tracks is not possible.
- During random play, the unit cannot find the beginning of any track which has been played.

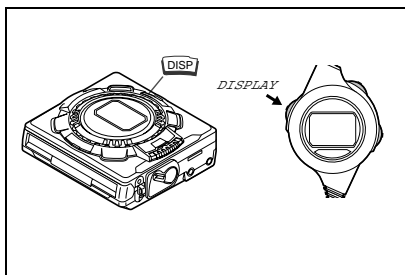

■ To check the remaining recording time and the total playing time

Whilst in the stop mode, press the DISP button on the main unit or the DISPLAY button on the remote control unit.

- Each time the button is pressed, the display will change as follows:

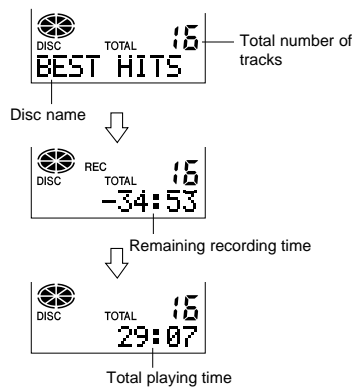

Note:
If character information was not originally recorded on the MiniDisc, nothing will be displayed.

■ To check the elapsed time and remaining time of the track

During playback, press the DISP button on the main unit or the DISPLAY button on the remote control unit.

- Each time the button is pressed, the display will change as follows:

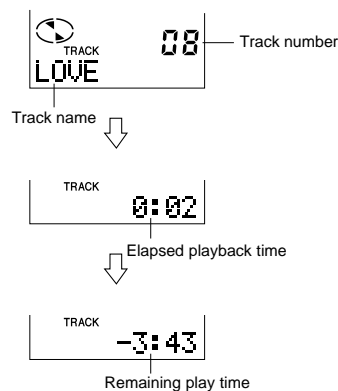

To display the playing time of an individual track:

Whilst in the stop mode, turn the jog dial to display the track number and track name, and then press the DISP button on the main unit or the DISPLAY button on the remote control unit to display the playing time for that track.

- Turn and hold the jog dial to display the playing time of the next track.

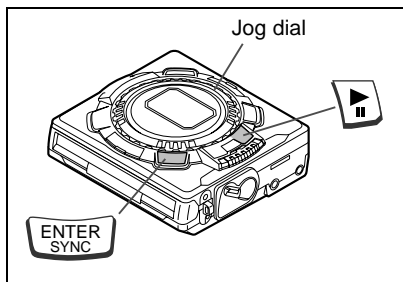

■ **To look for the track you want to listen to whilst in the stop mode**

When the jog dial is turned whilst in the stop mode, the track number and track name of the next (or previous) track will be displayed. When you find the track you want, you can start listening from that track.

- 1 Turn the jog dial to select the track number and track name.
To display the previous track name (the track number will be decreased) ... Turn the jog dial anti-clockwise.
To display the next track name (the track number will be increased) ... Turn the jog dial clockwise.
 - When the last disc track has been selected, if the jog dial is turned clockwise again the first track on the disc will be selected.
 - When the first disc track has been selected, if the jog dial is turned anti-clockwise again the last track on the disc will be selected.
- 2 Press the ► / || button to play the selected track.

Note:

- When no track names have been stored on a MiniDisc, no track names will be available for display.

■ **To look for another track you want to listen to during playback**

When the jog dial is turned during playback, the next (or previous) track number and track name will be displayed. You can start listening from any track you want. (Index (track name) search)

- 1 Turn the jog dial to select a track number and a track name.
To display the previous track name (the track number will be decreased) ... Turn the jog dial anti-clockwise.
To display the next track name (the track number will be increased) ... Turn the jog dial clockwise.
- 2 Press the ENTER/SYNC button to play the selected track.

■ **To look for the point at which you want to begin listening whilst in the pause mode**

When the jog dial is turned whilst in the pause mode, the elapsed time will be displayed, and you can begin listening from any point you like. (Time search)

- 1 Turn the jog dial to change the elapsed time.
To decrease the elapsed time ... Turn the jog dial anti-clockwise.
To increase the elapsed time ... Turn the jog dial clockwise.
- 2 Press the ► / || button to start playing from the selected point.

EDITING

■ What the editing function can do

You can create original discs using the MD editing function, on which you can change the order of the tracks and you can create disc or track names.

- Playback-only MiniDiscs cannot be edited.

Move (Page 29)

A designated track can be moved to any desired position.

- The numbers assigned to the tracks following the track which is moved will be adjusted automatically.

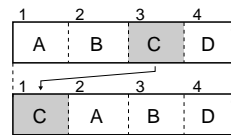

Divide (Page 29)

A single track can be divided into two at any desired position.

- The numbers of the tracks which come after the newly divided track will be automatically increased by one.

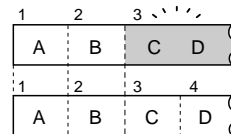

Combine (Page 30)

Two consecutive tracks can be combined into one track.

- The numbers assigned to the tracks following the combined tracks will be decreased by one automatically.

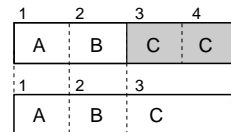

Disc/Track name (Page 30)

Discs and tracks (up to 255 tracks per disc) can be named. Since track names are displayed when the beginning of each track is located or during playback, you can quickly check the name of each track.

- Letters (capital letters/lowercase letters), numbers and symbols can be used.

Name/stamp (Page 32)

- All of the characters and data on a recorded MD (master MD with tracks and character information) can be transferred onto a recordable MD.

■ Move

- 1 Play the track to be moved, and press the ►|| button.
 - The unit will enter the pause mode.
- 2 Press the EDIT/MARK button and turn the jog dial to select "MOVE".

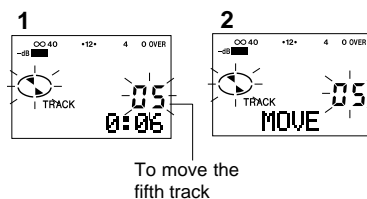

- 3 Press the ENTER/SYNC button.
 - To cancel the operation, press the ■:/OFF button.
- 4 Turn the jog dial to select the direction to move.
 - To increase the track number ... Turn the jog dial clockwise.
 - To decrease the track number ... Turn the jog dial anti-clockwise.

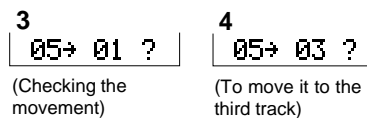

- 5 Press the ENTER/SYNC button again.
 - The track will be moved, and the unit will be paused at the beginning of the track.

Note:

- When a track has been moved, the other tracks which are affected by the move will be assigned new track numbers automatically.

Example: When moving the fifth track to the third track, the old third track will become the new fourth track and the old fourth track will become the new fifth track.

■ Divide

- 1 Start playing the track you want to divide into two. Press the ►|| button at the point where you want to divide the track.
 - The unit will enter the pause mode.
- 2 Press the EDIT/MARK button and turn the jog dial to select "DIVIDE".

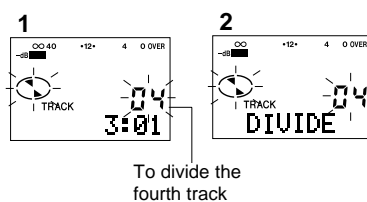

- 3 Press the ENTER/SYNC button.
 - To cancel the operation, press the ■:/OFF button.



(Confirming the split)

- 4 Press the ENTER/SYNC button again.
 - The track will be divided into two tracks, and the unit will be paused at the beginning of the second of the two tracks.
 - The numbers of the tracks which come after the divided track will be increased by one automatically.

Notes:

- When a track that has a name is divided, the two new tracks will have the same name. However, in the TOC FULL condition, the second track may not be named.
- Each disc can hold up to 255 tracks. However, even if the number of assigned tracks has not reached 254, it might not be possible to make any further divisions of tracks.

■ Combine

- 1 Start playing the last of the two tracks you want to combine, and press the ►|| button.
 - The unit will enter the pause mode.
- 2 Press the EDIT/MARK button and turn the jog dial to select "COMBINE".

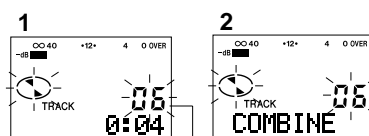

To combine the fifth and sixth tracks

- 3 Press the ENTER/SYNC button.
 - To cancel the operation, press the ■/OFF button.



(Confirming the combination)

- 4 Press the ENTER/SYNC button again.
 - The two tracks will be combined, and the unit will be paused at the beginning of the combined track.
 - The numbers assigned to the tracks following the combined track will be decreased by one automatically.

To combine two non-adjacent tracks:

First, put the two tracks next to each other in the order you want using the MOVE function (page 29). Then combine them using the COMBINE function.

When one or both tracks to be combined have a name:

The first track name will be used. However, when the first track does not have a name, the second track name will be used.

In the following cases, tracks cannot be combined.

- Tracks recorded in the monaural long-play mode and tracks recorded in the stereo mode.
- Tracks recorded from digital inputs and tracks recorded from analogue inputs.
- Tracks whose recording time is less than 12 seconds.

■ Disc name

- Discs can be named using a maximum of 100 characters.
- Up to 1,700 characters (approximately) can be used in the disc and track names on a single MiniDisc.

- 1 Whilst in the stop mode, press the EDIT/MARK button and turn the jog dial to select "DISC NAME".

- 2 Press the ENTER/SYNC button.
 - The unit will enter the character input mode.
 - To cancel the operation, press the ■/OFF button.

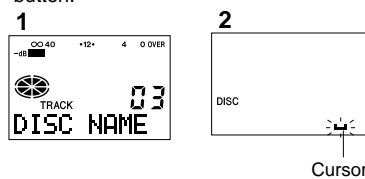

- 3 Press the CHARACTER button repeatedly to select the type of characters.
 - The first 3 characters in the group of the selected characters will be displayed for about 1 second.

! "# (Symbols)
↓
ABC (Capital letters)

- 4 Turn the jog dial to select the first letter in the name.
 - When the jog dial is held turned continuously, the displayed characters will change rapidly.

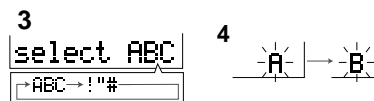

- 5 When the letter you want is displayed, move the shuttle switch up once.
- To enter more letters in the name, repeat steps 3 - 5.
- 6 When the disc name has been completely entered, press the ENTER/SYNC button again.

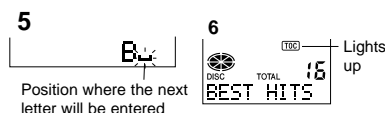

If an incorrect letter is entered:

To erase a character:

Move the shuttle switch to move the cursor to the character you want to erase. Then press the BASS button.

To correct a character:

Move the shuttle switch to move the cursor to the character you want to correct. Then enter the correct character.

- Even after all the letters have been entered, you can still go back and correct any mistakes.

When you want to enter lowercase letter:

Enter capital letters as described in step 4 and press the DISP button to change them to the lowercase letters.

If you press this button again, the letters will be changed back to capital letters.

To enter a space:

Move the shuttle switch to move the cursor to the right. Then, press the DISP button to enter a space.

Track name

Up to 100 characters can be entered for each name.

- 1 Play the track which you want to name, and press the ►|| button.
- The unit will enter the pause mode.
- 2 Press the EDIT/MARK button and turn the jog dial to select "Tr NAME".
- When "Tr NAME" is selected whilst in the stop mode, the track numbers can be selected using the jog dial.

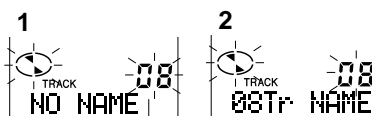

Track number that you want to give a track name

- 3 Press the ENTER/SYNC button.
- The unit will enter the character input mode.
- To cancel the operation, press the ■/OFF button.
- 4 Perform steps 3 - 5 in the "Disc name" section.
- 5 When the track name is completely entered, press the ENTER/SYNC button again.

Type of characters	Characters <symbols> (They are selected using the jog dial.)
Capital letters	<div style="display: flex; justify-content: space-between; align-items: center;"> <div style="display: flex; gap: 5px;"> [A][B][C][D][E]...[V][W][X][Y][Z] </div> <div style="display: flex; gap: 5px;"> [0][1][2][3][4][5]...[8][9] </div> <div style="margin-left: 20px;">→ Returns to []</div> </div>
Symbols	<div style="display: flex; justify-content: space-between; align-items: center;"> <div style="display: flex; gap: 5px;"> [][?][!][@][#]...[&][<][>] </div> <div style="display: flex; gap: 5px;"> [1][2][3][4][5][6][7][8][9] </div> <div style="margin-left: 20px;">→ Returns to []</div> </div>

[] indicates a space.

■ To change track names or disc names

Some MiniDiscs created on other equipment may have more than 100 characters in a track name or disc name. The characters from the 101st character and on cannot be corrected or changed.

To change characters:

- 1 Put the unit in the character input mode.
 - To change characters in a disc name, perform steps 1 - 2 on page 30.
 - To change characters in a track name, perform steps 1 - 3 on page 31.
- 2 Move the shuttle switch to move the cursor to the character you want to change.
- 3 Enter the new character you want, and press the ENTER/SYNC button.

To delete characters:

- 1 Put the unit in the character input mode.
 - To delete characters in a disc name, perform steps 1 - 2 on page 30.
 - To delete characters in a track name, perform steps 1 - 3 on page 31.
- 2 Move the shuttle switch to move the cursor to the character you want to delete.
- 3 Press the BASS button.
 - The character will be erased.
- 4 Press the ENTER/SYNC button.

To add characters:

- 1 Put the unit in the character input mode.
 - To add characters to a disc name, perform steps 1 - 2 on page 30.
 - To add characters to a track name, perform steps 1 - 3 on page 31.
- 2 Move the shuttle switch to move the cursor to the right of the character, where you want to add a new character.
- 3 Press the MODE button.
 - A space will be inserted.
- 4 Enter the new character you want, and press the ENTER/SYNC button.

■ Name/stamp

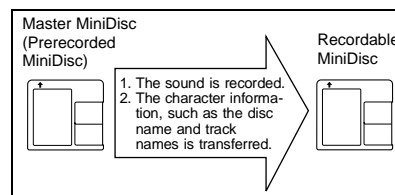

- 1 Record the sound from the master MiniDisc onto a recordable MiniDisc.

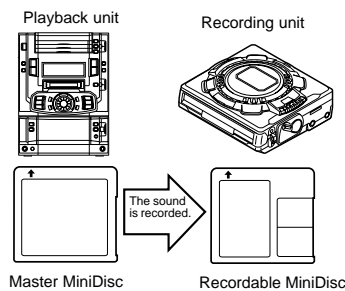

- Refer to the standard recording method. (Pages 9 to 13)
- At this point, only the sound is recorded. No character information is transferred.

- Check whether the total number of tracks on the newly recorded MiniDisc matches the total number of tracks on the master MiniDisc. If they do not match each other, combine or divide tracks using the edit operation. (Pages 29–30)
- This function can not be performed from playback only MiniDisc.

2 When the recording is complete, remove the newly recorded MiniDisc and load the master MiniDisc into the MD-MS722H.

- Do not mistake the master MiniDisc for the newly recorded MiniDisc.

3 Whilst in the stop mode, press the EDIT/MARK button and turn the jog dial to select “NAME STAMP”.

- 4** Press the ENTER/SYNC button.
- To cancel the operation, press the ■:/OFF button.



5 Press the ENTER/SYNC button.

- The character information of the master MiniDisc is being read.

6 When the unit displays “CHANGE MD”, remove the master MiniDisc.

- Remove the master MiniDisc without turning off the power. If you do, the operation will be cancelled.



7 Load the newly recorded MiniDisc into the MD-MS722H.

- To cancel the operation, press the ■:/OFF button.

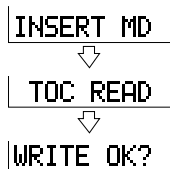

8 Press the ENTER/SYNC button.

- The unit will finish recording the character information and enter the stop mode.



Note:

- If the total number of tracks on the master MiniDisc does not match the total number of tracks on the newly recorded MiniDisc, the unit will display “Can’t WRITE” and the power will be turned off. If this happens, adjust the total number of tracks on the newly recorded MiniDisc using the edit operation, and then try again from step 2.

USING WITH OTHER EQUIPMENT

- Before connecting any other equipment, turn off the power to all units.
- Connect the plugs securely.
Improper connections may cause noise or malfunctions.

■ Listening through a stereo or a radio cassette player or recording on a cassette tape

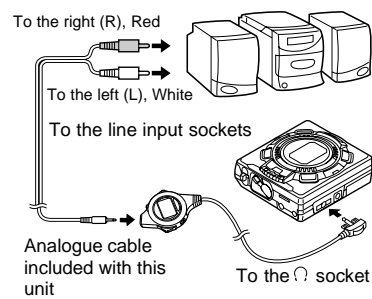

- The recording will be made in the analogue mode.
- When you want to listen to a disc using a separate stereo system or radio cassette player, it is recommended that you adjust the volume on the MiniDisc unit to maximum.

■ Listening through a car stereo

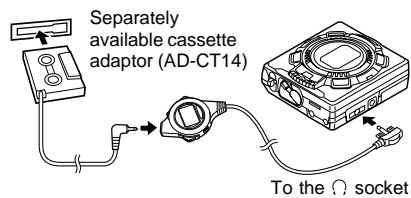

- The separately available cassette adaptor may not work, depending on your car's stereo.

CONVENIENT OPERATION OF THE UNIT

■ Checking the remaining amount of battery charge

The remaining amount of battery charge is shown by the battery indicator () during operation.

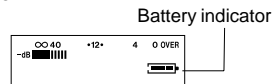

< How to read the battery indicator >

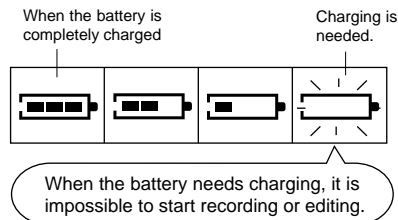

- When the battery is completely discharged, the whole battery indicator will flash. Recharge the battery or replace the alkaline battery with a new one.
- When the battery has run completely out, "BATT EMPTY" (main unit) and "Lo BATT" (remote control unit) will appear. Then, the power will be disconnected automatically.

Notes:

- When you are using the unit with a rechargeable battery and an alkaline battery and you want to check the remaining capacity of the battery, the remaining battery charge display may not be stable for about 20 seconds after the power is first turned on.
- When the AC adaptor included with this unit or a separately available car adaptor is used, the battery indicator will not be shown.
- The number of bars shown in the battery indicator may increase or decrease, depending on the operation being performed. This is normal.
- When the rechargeable battery and the alkaline battery are used at the same time, the rechargeable battery is used first, and then the alkaline battery. Since the battery indicator shows the remaining amount of the particular battery being used, the number of bars will increase when the unit switches to the alkaline battery.

■ To prevent the unit from being operated by mistake

To avoid operations being started by accidentally pressing the buttons, use the hold function.

Move the HOLD switch to the safety position (direction indicated by the arrow).

- When the unit is in the safety mode, pressing the buttons will have no effect.

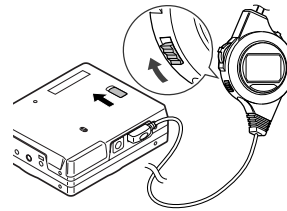

- To cancel the safety mode, move the HOLD switch away from the safety position (the opposite direction of the arrow).

	Remote control unit	Main unit
Can be operated from either the remote control unit or the main unit.	Cancel	Cancel
Can only be operated from the remote control unit.	Cancel	Hold
Can only be operated from the main unit.	Hold	Cancel
Cannot be operated from either the remote control unit or the main unit.	Hold	Hold

If the hold function is active whilst the power is turned off, the power cannot be turned on by mistake and the battery will not be accidentally drained.

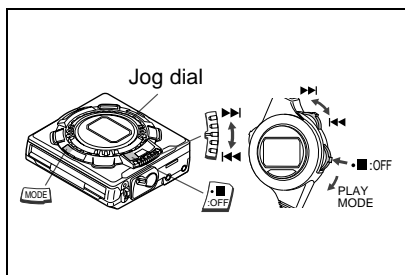

■ To eliminate the confirmation sound

Every time a button is pressed, a "beep" will be heard in the earphones. To silence the "beep" sound, do the following:

- 1 Whilst in the stop mode ...**
Hold down the MODE button on the main unit or move the shuttle switch on the lower right of the remote control unit down until "SET UP" appears.
 - When you release the button, "BEEP 1 (BEEP ON)" will appear.
- 2** Press the MODE button on the main unit or move the shuttle switch on the lower right of the remote control unit down.
 - "BEEP 0 (BEEP OFF)" will appear, and the confirmation sound will disappear.
 - To restore the confirmation sound, select "BEEP 1 (BEEP ON)".
- 3** Press the ■/OFF button.
 - The normal display will reappear.

■ To turn off the display backlight

Whenever you press a button, the display will light for about 7 seconds, so that you can read it in the dark. You can turn off the backlight.

- 1 Whilst in the stop mode ...**
Hold down the MODE button on the main unit or move the shuttle switch on the lower right of the remote control unit down until "SET UP" appears.
 - When you release the button, "BEEP 1 (BEEP ON)" or "BEEP 0 (BEEP OFF)" will appear.
- 2** Turn the jog dial until "EL on 1 (EL ON 1)" appears.
- 3** Press the MODE button on the main unit or move the shuttle switch on the lower right of the remote control unit down.
 - Whenever the button is pressed
EL ON 1 (EL on 1) → EL ON 2 (EL on 2)
↑ EL OFF (EL off) ↓
"EL OFF (EL off)" will go out.

To turn the backlight on:

"EL ON 1 (EL on 1)"
When any button is pressed, the backlight will remain lit for about 7 seconds.
"EL ON 2 (EL on 2)"
When the rechargeable battery or alkaline battery is used, the backlight will remain lit for about 7 seconds.
When the AC adaptor or a car adaptor is used and the power is turned on, the backlight will always be lit.
(However, the brightness may be a little less than when using the battery.)

- 4** Press the ■/OFF button.
 - The normal display will reappear.

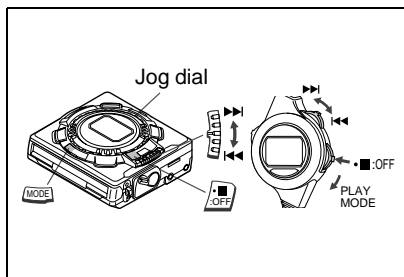

■ To cancel the auto-play function

When a MiniDisc is inserted, the power will be turned on automatically, and playback will begin. You can cancel automatic playback.

1 Whilst in the stop mode ...

Hold down the MODE button on the main unit or move the shuttle switch on the lower right of the remote control unit down until "SET UP" appears.

- When you release the button, "BEEP 1 (BEEP ON)" or "BEEP 0 (BEEP OFF)" will appear.

2 Turn the jog dial until "auto PL (A-PLAY ON)" appears.

3 Press the MODE button on the main unit or move the shuttle switch on the lower right of the remote control unit down.

- "PL off (A-PLAY OFF)" will appear, and the auto-play function will be cancelled.
- To restore the auto-play function, select "auto PL (A-PLAY ON)".

4 Press the ■/OFF button.

- The normal display will reappear.

■ To cancel the auto power save function

Power consumption can be reduced by controlling the memory storage time. You can cancel the auto power save function.

1 Whilst in the stop mode ...

Hold down the MODE button on the main unit or move the shuttle switch on the lower right of the remote control unit down until "SET UP" appears.

- When you release the button, "BEEP 1 (BEEP ON)" or "BEEP 0 (BEEP OFF)" will appear.

2 Turn the jog dial until "auto PS (AUTO Psave)" appears.

3 Press the MODE button on the main unit or move the shuttle switch on the lower right of the remote control unit down.

- "PS off (Psave off)" will appear, and the auto power save function will be cancelled.
- To restore the auto power save function, select "auto PS (AUTO Psave)".

4 Press the ■/OFF button.

- The normal display will reappear.

About the sound skip guard memory:

During playback, approximately 40 seconds of information is stored in the semiconductor memory. Therefore, even when the pickup cannot read information for a second or two due to an external shock, the sound will continue without interruption because the information stored in memory is used.

About the auto power save function:

This is a function used to save power when using the unit with the rechargeable battery or the alkaline battery. Whilst in the auto power save mode, 10 - 40 seconds of sound information is stored in memory. When the unit is used in places exposed to excessive vibration, cancel the auto power save function. When the auto power save function is disabled, 40 seconds of sound information is always stored in memory. (When the AC adaptor or a car adaptor is used, the information storage time is always 40 seconds, regardless of the auto power save mode.)

WHAT IS A MINIDISC?

A MiniDisc is a disc inside a protective cartridge. You can handle it freely without worrying about dust, fingerprints, etc. However, if dust enters the opening of the cartridge, or there is excessive dirt on the cartridge, or the cartridge becomes warped, you may experience malfunctions. Please note the following.

■ Handling the MiniDisc

Do not touch the disc directly!

Do not open the shutter or touch the disc directly.

If the shutter is opened forcibly, it may break.

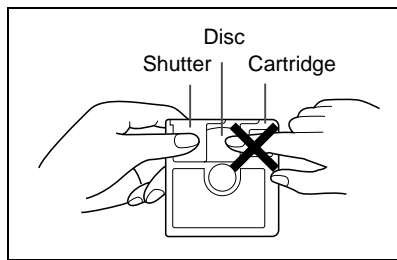

- Never disassemble a MiniDisc.

■ Where not to store discs

Do not store discs in places with high temperatures or humidity. Specifically, do not leave discs in places exposed to direct sunlight or in cars with the doors and windows closed.

Do not leave discs in places where sand can get into the cartridge easily (e.g., beaches).

■ Helpful tip when attaching a label

When attaching a label to an MD cartridge, be sure to note the following. If the label is not attached properly, the MiniDisc may jam inside the unit and it may not be possible to remove it.

- If the label peels off or partially lifts away, replace it with a new one.
- Do not put a new label on top of an existing one.
- Attach the label only in the specified location. (If it is not within the specified area, it may cause the disc to jam in the unit.)

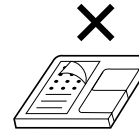

■ Regular cleaning

If the surface of the cartridge becomes dusty or dirty, clean it with a dry cloth.

TROUBLESHOOTING

■ Moisture condensation

In the following cases, condensation may form inside the unit.

- Shortly after turning on a heater.
- When the unit is placed in a room where there is excessive steam or moisture.
- When the unit is moved from a cool place to a warm place.

When the unit has condensation inside, the disc signals cannot be read, and the unit may not function properly.

- If this happens, remove the disc. The condensation should evaporate in approximately 1 hour. The unit will then function properly.

Many potential "problems" can be resolved by the owner without calling a service technician. If something seems to be wrong with this product, check the following before calling your authorised SHARP dealer or service centre.

PROBLEM	CAUSE
The unit does not turn on.	<ul style="list-style-type: none"> ● Is the AC adaptor disconnected? ● Is the battery exhausted? ● Is the unit in the safety mode? ● Has condensation formed inside the unit? ● Is the unit being influenced by mechanical shock or by static electricity?
No sound is heard from the earphones.	<ul style="list-style-type: none"> ● Is the volume set too low? ● Is the remote control unit or the earphones plugged in? ● Are you trying to play a MiniDisc with data on it instead of a MiniDisc containing music?
When the operation buttons are pressed, the unit does not respond.	<ul style="list-style-type: none"> ● Is the unit in the safety mode? ● Is the battery exhausted? ● Is the remote control unit plug or the earphone plug inserted firmly?
Some sounds are skipped.	<ul style="list-style-type: none"> ● Is the battery exhausted? ● Is the unit being subjected to excessive vibration?
The MiniDisc cannot be ejected.	<ul style="list-style-type: none"> ● Has the track number or character information been written on the disc yet? ● Is the unit in the recording or editing mode?
Recording and editing are impossible.	<ul style="list-style-type: none"> ● Is the MiniDisc protected against accidental erasure? ● Is the unit connected properly to the other equipment? ● Is the AC adaptor unplugged or did a power failure occur whilst recording or editing? ● Is the unit in the safety mode? ● Is an optical signal being output from the external equipment? <p>Read the operation manual for the external equipment.</p>

■ If trouble occurs

When this product is subjected to strong external interference (mechanical shock, excessive static electricity, abnormal supply voltage due to lightning, etc.) or if it is operated incorrectly, it may malfunction. If such a problem occurs, do the following:

1. Unplug the AC adaptor from the AC socket.
2. Remove the battery.
3. Leave the unit completely unpowered for approximately 30 seconds.

4. Plug the AC adaptor back into the AC socket and retry the operation.

If strange sounds, smell or smoke come out of the unit or an object is dropped into the unit, remove the AC adaptor from the AC socket immediately and contact an authorised SHARP service centre.

MINIDISC SYSTEM LIMITATIONS

MiniDiscs are recorded using a different system than is used for cassette tapes or DAT recordings. Therefore, the following conditions may be encountered, depending on how the disc has been recorded or edited. These are due to system limitations, and should be considered normal.

<p>Even if the maximum recording time of a MiniDisc has not been reached, "DISC FULL" or "TOC FULL" may be displayed.</p>	<p>When the number of tracks used reaches the limit, regardless of the remaining recording time, further recording will be impossible. (Maximum number of tracks: 254) If a MiniDisc has been recorded or edited repeatedly or if a MiniDisc has scratches on it, it may not be possible to record the maximum number of tracks on it.</p>
<p>Even if the number of tracks and the recording time have not reached the limit, "DISC FULL" may be displayed.</p>	<p>If there are scratches on a disc, the unit will automatically avoid recording in those areas. The recording time will be reduced.</p>
<p>Even if several short tracks are erased, the remaining recording time may not show an increase.</p>	<p>When the remaining recording time of a disc is displayed, short tracks less than 12 seconds long may not be included in the total.</p>
<p>Two tracks may not be combined in editing.</p>	<p>For MiniDiscs on which repeated recording and editing operations were performed, the COMBINE function may not work.</p>
<p>The total of the recorded time and time remaining on a disc may not add up to the maximum possible recording time.</p>	<p>A cluster (about 2 seconds) is normally the minimum unit of recording. So, even if a track is less than 2 seconds long, it will use about 2 seconds of space on the disc. Therefore, the time actually available for recording may be less than the remaining time displayed. If there are scratches on discs, those sections will be automatically avoided (no recording will be placed in those sections). Therefore, the recording time will be reduced.</p>
<p>When recorded tracks are played back using the cue and review operations, some sounds may be skipped.</p>	<p>For MiniDiscs on which repeated recording and editing were performed, some sounds may be skipped whilst cueing and reviewing.</p>
<p>A track number can be created in the middle of a track.</p>	<p>If there are scratches or dust on a MiniDisc, the track numbers following that track will be increased by one.</p>

ERROR MESSAGES		
Error messages	Meaning	Remedy
BATT EMPTY (Lo BATT)	● The battery run down.	● Charge the rechargeable battery or replace the alkaline battery (or use the AC adaptor for power).
BLANK DISC (BLANK)	● Nothing is recorded.	● Replace the disc with a recorded disc.
Can't COPY (Not REC)	● No copy can be made because of the SCMS copyright system.	● Record using the analogue cable.
Can't EDIT	● A track cannot be edited.	● Change the stop position of the track and then try editing it.
Can't REC (Not REC)	● Recording cannot be performed correctly due to vibration or shock in the unit.	● Re-record or replace it with another recordable disc.
Can't WRITE	● Editing is impossible.	● Check the number of tracks.
DEFECT (DEFECT)	● The disc is scratched.	● If the sound you hear is not right, try recording again. ● Replace the disc with another recordable disc.
Din UNLOCK (UNLOCK)	● Poor connection of the digital cable.	● Connect the digital cable securely.
DISC ERROR (E-DISC)	● The disc is damaged.	● Reload the disc or replace it.
DISC FULL	● The disc is out of recording space.	● Replace it with another recordable disc.
HOLD (HOLD)	● The unit is in the safety mode.	● Return the HOLD switch to its original position.
LOCKED LOCK ERROR	● The EJECT lever was moved during recording or editing.	● Turn off the power and remove the MiniDisc.
NO DISC	● A disc has not been loaded.	● Load a disc.
PB DISC PROTECTED	● The disc is write protected. ● You tried to record on a playback-only disc.	● Move the write protection knob back to its original position. ● Replace it with a recordable disc.
POWER ?	● Improper power is being supplied.	● Use one of the specified power sources.
SORRY (SORRY)	● Since a track number is currently being located or written to, the unit cannot accept your command.	● Wait for a while and try the operation again.
SYSTEM ERR (E-SYS)	● You have come to the conclusion that the unit is out of order.	● To have it repaired, go to the distributor where you purchased the unit.
TEMP OVER (E-TEMP)	● The temperature is too high.	● Turn off the power, and wait for a while.
TOC ERROR (E-TOC)	● A large portion of the disc has been damaged.	● Replace it with another recorded disc.
TOC FULL	● There is no space left for recording character information (track names, disc names, etc.).	● Replace it with another recordable disc.
Tr. Protect	● The track has been protected from being erased.	● Edit the track with the device on which it was recorded.
U TOC ERROR (E-UTOC)	● A large portion of the disc has been damaged. ● There is an error in the recorded signal.	● Replace it with another recorded disc. ● Erase all of the signal errors, and then try recording again.
? DISC (?DISC)	● A disc which contains data other than music was played. ● There is an error in the signal from the disc.	● A disc which contains non-music data cannot be played. ● Replace it with another recorded disc.

(): Error messages seen on the remote control.

MAINTENANCE

■ Cleaning

When the unit becomes dirty

Clean it with a soft cloth.

When the unit is excessively dirty, use a soft cloth dampened in water.

(External surfaces only)

Notes:

- Do not use chemicals for cleaning (petrol, paint thinner, etc.) It may affect the quality or colour.
- Do not apply oil to the inside of the unit. It may cause malfunctions.

Clean the earphone plug and the connecting cable plug.

This will prevent noise.

SPECIFICATIONS

As a part of our policy of continuous improvement, SHARP reserves the right to make design and specification changes for product improvement without prior notice. The performance specification figures indicated are nominal values of production units. There may be some deviations from these values in individual units.

■ General

Power source:	DC 3.6V (rechargeable lithium-ion battery x 1) DC 5V (AC adaptor) AC 230 - 240V, 50/60 Hz DC 3.4V: Battery case (commercially available, "AA" size, alkaline battery x 1) DC 4.5V: Separately available car adaptor, AD-CA20X (for cars with a 12-24V DC negative earth electrical system)
Power consumption:	7 W (AC adaptor)
Output power:	RMS; 20 mW (10 mW + 10 mW) (0.2% T.H.D.)
Charging time:	Approx. 3 hours (When using the AC adaptor included with the unit)
Battery life:	

When using the rechargeable battery (fully charged) included with the unit	When using one, commercially available, high capacity, "AA" size, alkaline battery (in the battery case)	When using one, commercially available, high capacity, "AA" size battery with the rechargeable battery (fully charged)
Continuous recording: Approx. 8 hours	Continuous recording: Approx. 3 hours	Continuous recording: Approx. 11 hours
Continuous play: Approx. 10 hours	Continuous play: Approx. 6 hours	Continuous play: Approx. 16 hours

- The continuous recording time is for analogue inputs when the volume level is set to "VOL 0".
- The continuous play time shows the value when the volume level is set to "VOL 15".
- The above values are the standard values when the unit is charged and used at an ambient temperature of 20°C.
- The operating time when using an alkaline battery may be different, depending on the type and manufacturer of the battery, and on the operating temperature.

Input sensitivity:

Recording level	Reference input level	Input impedance
MIC H	0.25 mV	10 k ohms
MIC L	2.5 mV	10 k ohms
LINE	100 mV	20 k ohms

Output level:

	Specified output	Maximum output level	Load impedance
Earphones	—	10 mW + 10 mW	32 ohms
LINE	300 mV (-12dB)	—	10 k ohms

Dimensions:

Width: 87.0 mm (3-7/16")
 Height: 26.7 mm (1-1/16")
 Depth: 81.5 mm (3-1/4")

Weight:

220 g (0.49 lbs.) with rechargeable battery

Input socket:

Line/optical digital, microphone (powered by the main unit)

Output socket:

Earphones (impedance: 32 ohms)/
 remote control unit

■ MiniDisc Recorder

Type:

Portable MiniDisc recorder

Signal readout:

Non-contact, 3-beam semi-conductor laser pick-up

Audio channels:

Stereo 2 channels/monaural (long-play mode) 1 channel

Frequency response:

20 – 20,000 Hz (± 3 dB)

Rotation speed:

Approx. 400 – 900 rpm

Error correction:

ACIRC (Advanced Cross Interleave Reed-Solomon Code)

Coding:

ATRAC (Adaptive TRansform Acoustic Coding), 24-bit computed type

Recording method:

Magnetic modulation overwrite method

Sampling frequency:

44.1 kHz (32 kHz and 48 kHz signals are converted to 44.1 kHz, and then recorded.)

Wow and flutter:

Unmeasurable (less than ±0.001% W. peak)

MEMO

MEMO

MEMO

TERMS OF GUARANTEE

Subject to the terms listed below, Sharp Electronics (U.K.) Ltd. (hereinafter called "the Company") guarantee to provide for the repair of, or at its option replace this Sharp Equipment, or any component thereof, (other than batteries), which is faulty or below standard, as a result of inferior workmanship or materials.

The conditions of this guarantee are:

1. The guarantee shall only apply to defects which occur within one year from the date of purchase, provided that this equipment is sent to the repair address within this period.
2. This guarantee covers equipment intended for private domestic use only. This guarantee does not apply to equipment used in the course of a business, trade or profession.
3. This guarantee does not cover any faults or defects caused by accident, misuse, fair wear and tear, neglect, tampering with the equipment, or any attempt at adjustment or repair other than by the Company's MiniDisc or telephone service centre.
4. In the unlikely event of a defect occurring, the product must be returned to the Company's repair centre with proof of purchase. A postage paid label and a fault report form are supplied with the product for this purpose. It is your responsibility to ensure that the packaging is adequate, and to obtain proof of posting. Further details of the repair service, which is available after the guarantee period on a chargeable basis, and additional report forms and labels can be obtained by telephoning 01623 413800.
5. No person has any authority to vary the terms or conditions of this guarantee.
6. This guarantee is offered as an additional benefit to the consumer's statutory rights and does not affect these rights in any way.

SHARP

SHARP ELECTRONICS (U.K.) LTD.

Sharp House, Thorp Road, Newton Heath, Manchester, M40 5BE

SHARP CORPORATION

TINSE1604AFZZ

Printed in Japan
A9809.3.0MNS.SM

MD-MS722H(SUK)