



SHARP

MD COMPACT COMPONENT SYSTEM

MODEL

MD-MX30H

OPERATION MANUAL

Thank you for purchasing this SHARP product.
To obtain the best performance from this product, please read this manual carefully. It will guide you in operating your SHARP product.

MD-MX30H MD Compact Component System consisting of MD-MX30H (main unit) and CP-MX30H (speaker system).

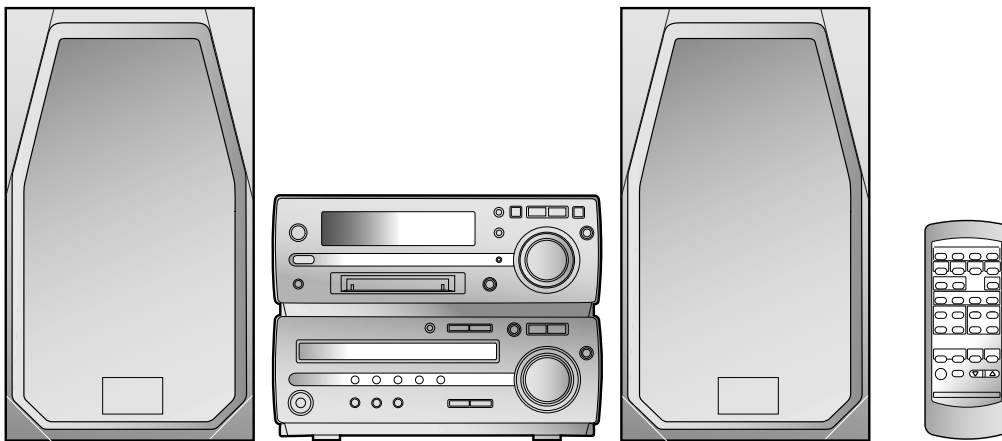



CONTENTS

	Page		Page
SPECIAL NOTES	1	RECORDING	31-35
ACCESSORIES	2	EDITING	36-41
PRECAUTIONS	2	TIMER OPERATION	42-43
NAMES OF CONTROLS AND INDICATORS	3-5	USING EXTERNAL UNITS	44-45
PREPARATION FOR USE	6-8	WHAT IS A MINIDISC?	46
SETTING THE CLOCK	9	MINIDISC SYSTEM LIMITATIONS	47
SOUND CONTROL	10	TROUBLESHOOTING	47-48
COMPACT DISC OPERATION	11	RESETTING THE MICROCOMPUTER	48
MINIDISC OPERATION	12	ERROR MESSAGES	49
CONVENIENT CD AND MINIDISC OPERATIONS	13-16	MAINTENANCE	50
RADIO OPERATION	17-18	SPECIFICATIONS	50
RDS (Radio Data System) OPERATION	19-30	TERMS OF GUARANTEE	Back cover



SPECIAL NOTES

NOTE FOR USERS IN THE U.K.

The mains lead of this product is fitted with a non-rewireable (moulded) plug incorporating a 3A fuse. Should the fuse need to be replaced, a BSI or ASTA approved BS 1362 fuse marked  or  and of the same rating as above, which is also indicated on the pin face of the plug must be used.

Always refit the fuse cover after replacing the fuse. Never use the plug without the fuse cover fitted.

In the unlikely event of the socket outlet in your home not being compatible with the plug supplied, cut-off the mains plug and fit an appropriate type.

DANGER:

The fuse from the cut-off plug should be removed and the cut-off plug destroyed immediately and disposed of in a safe manner.

Under no circumstances should the cut-off plug be inserted elsewhere into a 13A socket outlet as a serious electric shock may occur.

To fit an appropriate plug to the mains lead, follow the instructions below:

IMPORTANT:

The wires in the mains lead are coloured in accordance with the following code:

Blue : Neutral
Brown : Live

As the colours of the wires in the mains lead of this product may not correspond with the coloured markings identifying the terminals in your plug, proceed as follows:

- The wire which is coloured blue must be connected to the plug terminal which is marked N or coloured black.
- The wire which is coloured brown must be connected to the plug terminal which is marked L or coloured red.

Ensure that neither the brown nor the blue wire is connected to the earth terminal in your three pin plug.

Before replacing the plug cover, make sure that:

- If the new fitted plug contains a fuse, its value is the same as that removed from the cut-off plug.
- The cord grip is clamped over the sheath of the mains lead and not simply over the lead wires.

IF YOU HAVE ANY DOUBT, CONSULT A QUALIFIED ELECTRICIAN.

SERVICE INFORMATION

In the unlikely event of your equipment requiring repair, please contact the dealer or supplier from whom it was purchased. Where this is not possible, please contact the telephone number listed below.

You will then be given details of how to obtain service.
- 0345-125387 -

Please note; all calls will be charged at local rate.

Certain replacement parts and accessories may be obtained from our main parts distributor.

WILLOW VALE ELECTRONICS LTD.

MANCHESTER 0161-682-1415

READING 01189-876444

In the unlikely event of this equipment requiring repair during the guarantee period, you will need to provide proof of the date of purchase to the repairing company.

Please keep your invoice or receipt, which is supplied at the time of purchase.

- Recording and playback of any material may require consent, which SHARP is unable to give. Please refer particularly to the provisions of the Copyright Act 1956, the Dramatic and Musical Performers Protection Act 1958, the Performers Protection Acts 1963 and 1972 and to any subsequent statutory enactments and orders.
- This equipment complies with the requirements of Directives 89/336/EEC and 73/23/EEC as amended by 93/68/EEC.
- When the ON/STAND-BY button is set at STAND-BY position, mains voltage is still present inside the unit. When the ON/STAND-BY button is set at STAND-BY position, the unit may be brought into operation by the timer mode or remote control.
- US and foreign patents licensed from Dolby Laboratories Licensing Corporation.

Warning:

- This unit contains no user serviceable parts. Never remove covers unless qualified to do so. This unit contains dangerous voltages, always remove mains plug from the socket before any service operation and when not in use for a long period.

Warning:

- To prevent fire or shock hazard, do not expose this appliance to dripping or splashing. No objects filled with liquids, such as vases, shall be placed on the apparatus.

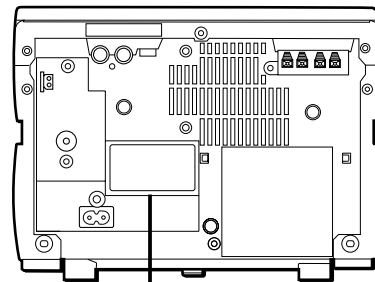

CLASS 1 LASER PRODUCT
APPAREIL À LASER DE CLASSE 1
PRODUCTO LASER DE CLASE 1

CAUTION

Use the MD compact component system only in accordance with the instructions given in this manual and do not attempt to interfere with the interlock switch or make any other adjustment as this may result in exposure to hazardous radiation.

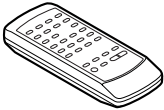
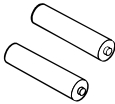
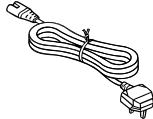
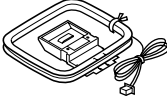
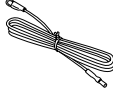
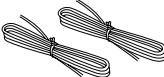
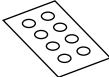

ACCESSORIES

 Remote control × 1	 "AA" size battery (UM/SUM-3, R6, HP-7 or similar) × 2	 AC power lead × 1
 AM loop aerial × 1	 FM aerial × 1	 Speaker wire × 2
		 Speaker cushion × 8

Note:

Parts and accessories mentioned in this operation manual other than those in the drawing are not included.

PRECAUTIONS

General

- Please ensure that the equipment is positioned in a well ventilated area and ensure that there is at least 10cm (4") of free space along the sides and back. There must also be a minimum of 10cm (4") of free space on the top of the unit.
- Do not use oil, solvents, petrol, paint thinners or insecticides on the unit.
- Do not expose the unit to moisture, to temperatures higher than 60°C (140°F) or to extreme low temperatures.
- Keep the unit away from direct sunlight, strong magnetic fields, excessive dust, humidity and electronic/electrical equipment (home computers, facsimiles, etc.) which generate electrical noise.
- Hold the AC power plug by the head when removing it from the AC socket, since pulling the lead can damage internal wires.
- Do not remove the outer cover, as this may result in electric shock.
Refer internal service to your local SHARP service facility.
- Use the unit on a firm, level surface free from vibration, and do not place anything on the top of the unit.
- If the unit malfunctions whilst in use, press the ON/STANDBY button to enter the stand-by mode, then disconnect the AC power lead from the AC socket. Plug the AC power lead back in, and then press the ON/STANDBY button to turn the power on.
- If an electrical storm is taking place near you, it is suggested that you disconnect the AC power lead from the AC socket for safety.
- The ventilation should not be impeded by covering the ventilation openings with items, such as newspapers, tablecloths, curtains, etc.
- No naked flame sources, such as lighted candles, should be placed on the apparatus.
- Attention should be drawn to the environmental aspects of battery disposal.
- The apparatus is designed for use in moderate climate.

Warning:

- The voltage used must be the same as that specified on this unit. Using this product with a higher voltage other than which is specified is dangerous and may result in a fire or other type of accident causing damage. SHARP will not be held responsible for any damage resulting from use of this unit with a voltage other than that which is specified.

Care of compact discs

Compact discs are fairly resistant to damage, however mistracking can occur due to an accumulation of dirt on the disc surface.

Follow the guidelines below for maximum enjoyment from your CD collection and player.

- Do not write on either side of the disc, particularly the non-label side.
Signals are read from the non-label side. Do not mark this surface.
- Keep your discs away from direct sunlight, heat, and excessive moisture.
- Always hold the CDs by the edges. Fingerprints, dirt, or water on the CDs can cause noise or mistracking. If a CD is dirty or does not play properly, clean it with a soft, dry cloth, wiping straight out from the centre, along the radius.

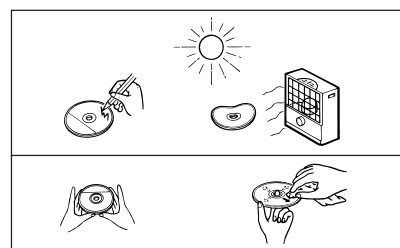

Volume control

The sound level at a given volume setting depends on a combination of speaker efficiency, location and various other factors.

It is advisable to avoid exposure to high volume levels, which occur whilst turning the unit on with the volume control setting up high, or whilst continually listening at high volumes.

Condensation

Sudden temperature changes, storage or operation in an extremely humid environment may cause condensation inside the cabinet (CD pickup, MiniDisc pickup, etc.) or on the transmitter LED on the remote control.

Condensation can cause the unit to malfunction.

If this happens, leave the power on with no disc in the unit until normal playback is possible (about 1 hour). Wipe off any condensation on the remote control transmitter LED with a soft cloth before operating the unit.





NAMES OF CONTROLS AND INDICATORS

■ Front panel

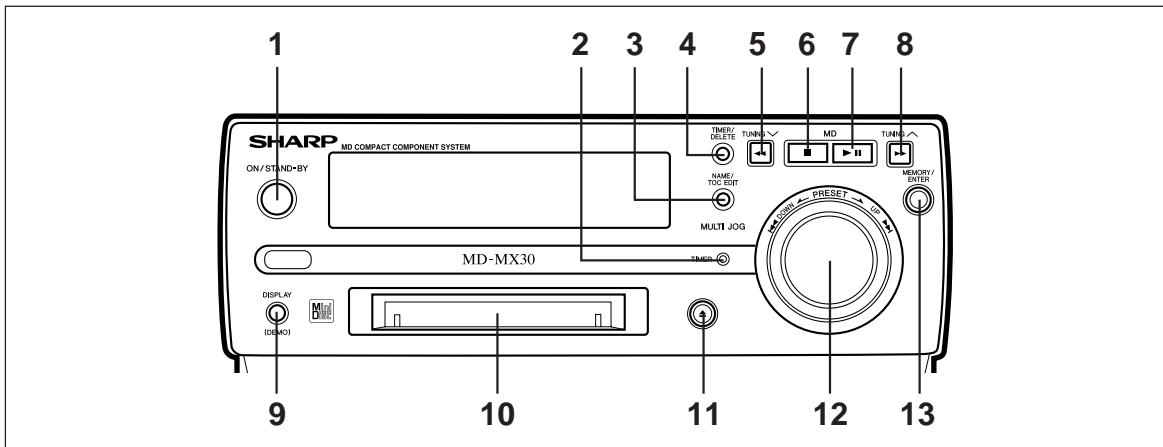

- | | | |
|------------------------------|--------------------------|-------------------------|
| 1. On/Stand-by Button | 6. MD Stop Button | 11. MD Eject Button |
| 2. Timer Stand-by Indicator | 7. MD Play/Pause Button | 12. Jog Dial |
| 3. Name/TOC Edit Button | 8. Tuning Up/Cue Button | 13. Memory/Enter Button |
| 4. Timer/Delete Button | 9. Display (Demo) Button | |
| 5. Tuning Down/Review Button | 10. MD Compartment | |

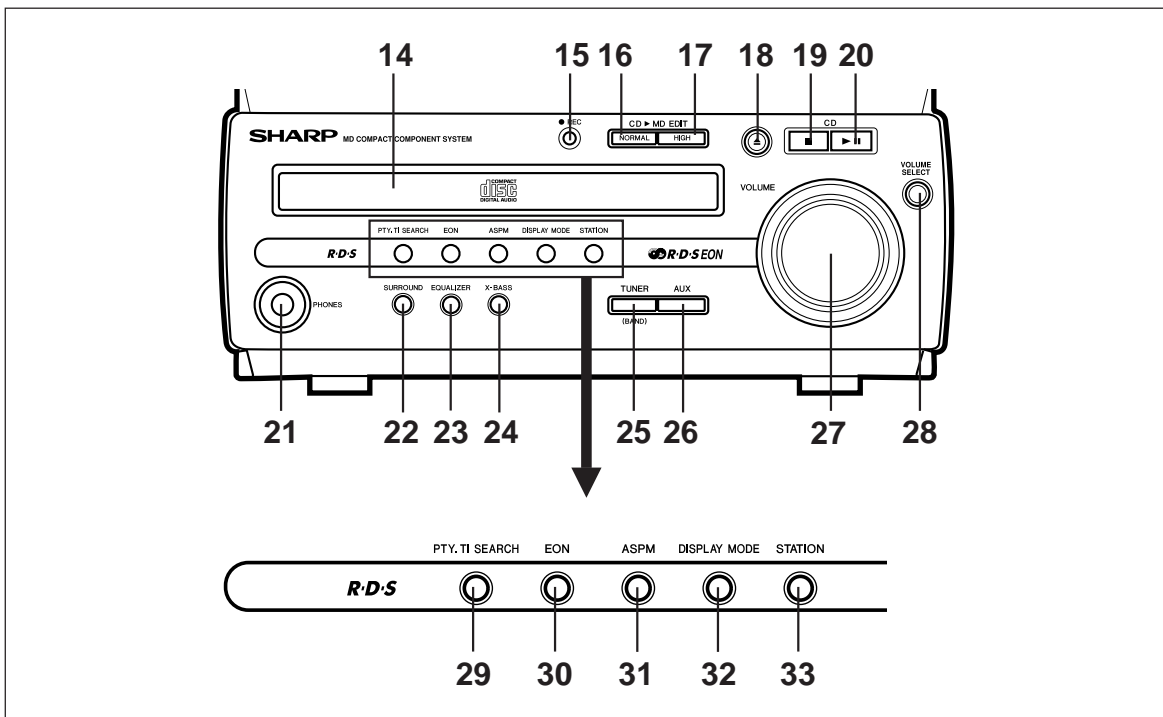

- | | | |
|---|-----------------------------|--|
| 14. CD Compartment | 20. CD Play/Pause Button | 28. Volume Select Button |
| 15. Record Button | 21. Headphone Socket | 29. Programme Type/Traffic Information Search Button |
| 16. CD Play/Pause MD Normal Speed Edit Button | 22. Surround Button | 30. EON Button |
| 17. CD Play/Pause MD High Speed Edit Button | 23. Preset Equalizer Button | 31. Auto Station Programme Memory Button |
| 18. CD Open/Close Button | 24. Extra Bass Button | 32. Display Mode Button |
| 19. CD Stop Button | 25. Tuner (Band) Button | 33. Station Selector Button |
| | 26. Auxiliary Button | |
| | 27. Volume Control | |



(Continued)

■ Display window

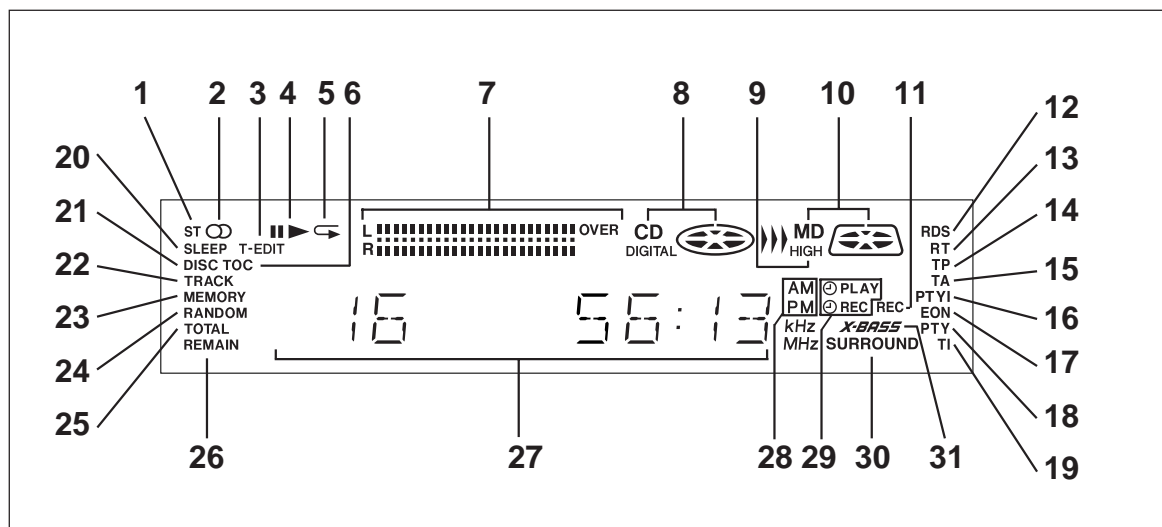

- | | | |
|------------------------------|------------------------------------|---------------------------------------|
| 1. FM Stereo Indicator | 12. RDS Indicator | 23. Memory Indicator |
| 2. FM Stereo Mode Indicator | 13. Radio Text Indicator | 24. Random Play Indicator |
| 3. Track Edit Indicator | 14. Traffic Programme Indicator | 25. Total Time Indicator |
| 4. Play/Pause Indicator | 15. Traffic Announcement Indicator | 26. Remaining Time Indicator |
| 5. Repeat Indicator | 16. Dynamic PTY Indicator | 27. Character Information Display |
| 6. TOC Indicator | 17. EON Indicator | 28. AM/PM Indicator |
| 7. Level Meters | 18. Programme Type Indicator | 29. Timer Record/Timer Play Indicator |
| 8. CD Indicator | 19. Traffic Information Indicator | 30. Surround Indicator |
| 9. High Speed Edit Indicator | 20. Sleep Indicator | 31. Extra Bass Indicator |
| 10. MD Indicator | 21. Disc Indicator | |
| 11. Record Indicator | 22. Track Indicator | |

■ Rear panel

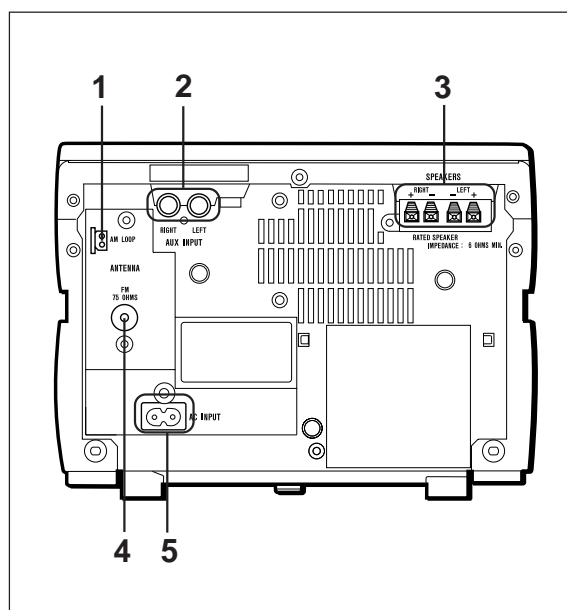

1. AM Loop Aerial Socket
2. Auxiliary Input Sockets
3. Speaker Terminals
4. FM 75 Ohms Aerial Socket
5. AC Input Socket



(Continued)

■ Remote control

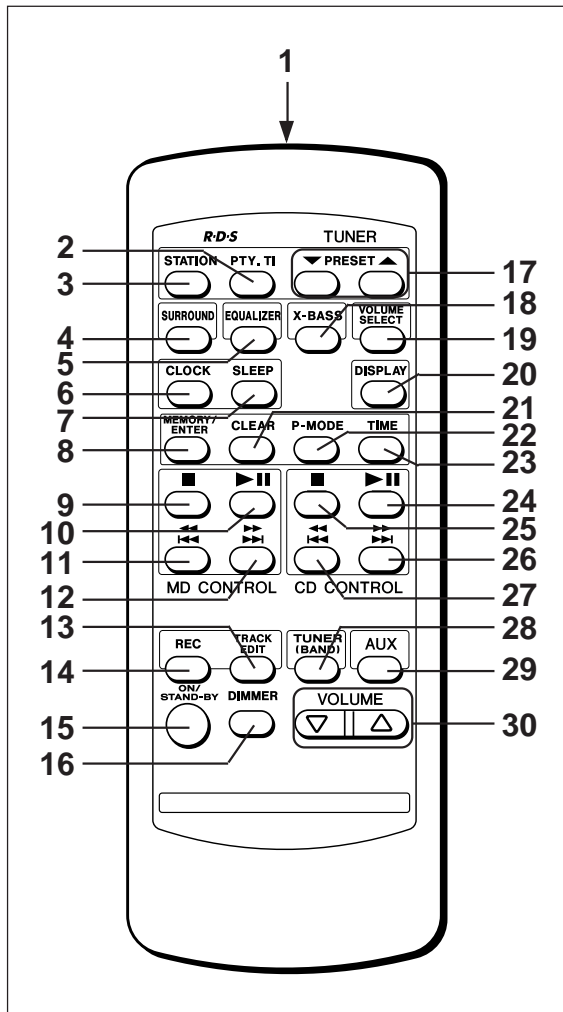

1. Remote Control Transmitter LED
2. Programme Type/Traffic Information Search Button
3. Station Selector Button
4. Surround Button
5. Preset Equalizer Button
6. Clock Button
7. Sleep Button
8. Memory/Enter Button
9. MD Stop Button
10. MD Play/Pause Button
11. MD Track Down/Review Button
12. MD Track Up/Cue Button
13. Track Edit Button
14. Record Button
15. On/Stand-by Button
16. Dimmer Button
17. Tuner Preset Up/Down Buttons
18. Extra Bass Button
19. Volume Select Button
20. Display Button
21. Clear Button
22. Play Mode Button
23. Time Button
24. CD Play/Pause Button
25. CD Stop Button
26. CD Track Up/Cue Button
27. CD Track Down/Review Button
28. Tuner (Band) Button
29. Auxiliary Button
30. Volume Buttons

■ Speaker section

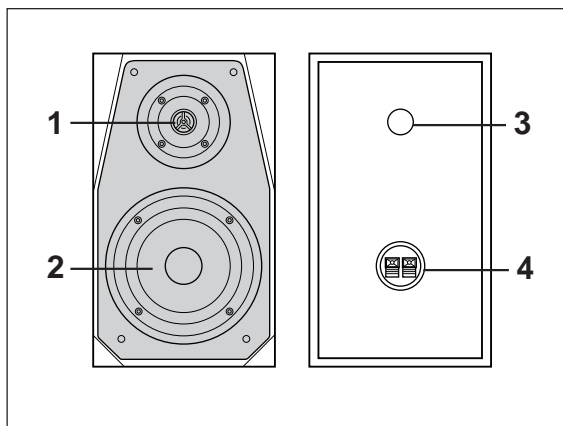

1. Tweeter
2. Woofer
3. Bass Reflex Duct
4. Speaker Terminals



PREPARATION FOR USE

Unplug the AC power lead from the AC socket before connecting or disconnecting any component.

■ Aerial connection

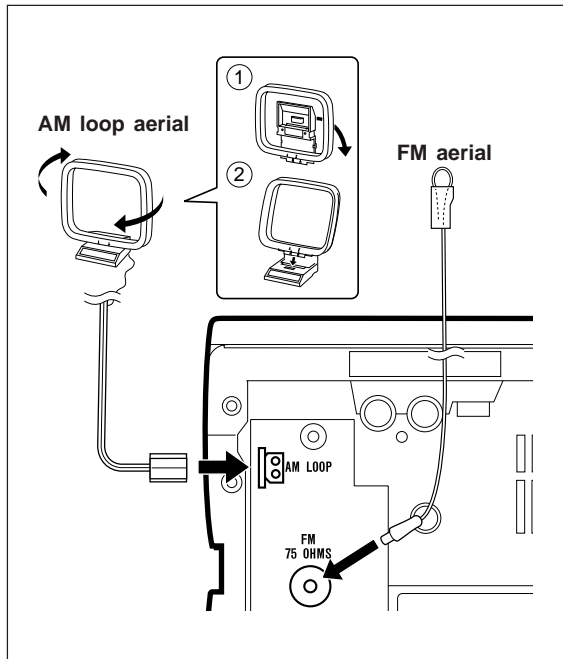

Supplied FM aerial

Connect the FM aerial wire to the FM 75 OHMS socket and position the FM aerial wire in the direction where the strongest signal can be received.

Supplied AM loop aerial

Connect the AM loop aerial wire to the AM LOOP socket. Position the AM loop aerial for optimum reception. Place the AM loop aerial on a shelf, etc., or attach it to a stand or a wall with screws (not supplied).

Notes:

- Do not place the aerial on the main unit as it may result in noise pickup from the internal digital electronics. Place the aerial away from the unit for better reception.
- If the AM loop aerial and the FM aerial wire are placed near the AC power lead, interference may result.

External FM aerial

Use an external FM aerial if you require better reception. Consult your dealer.

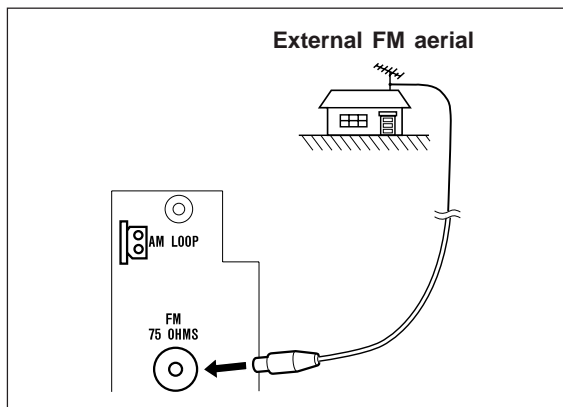

■ Speaker connection

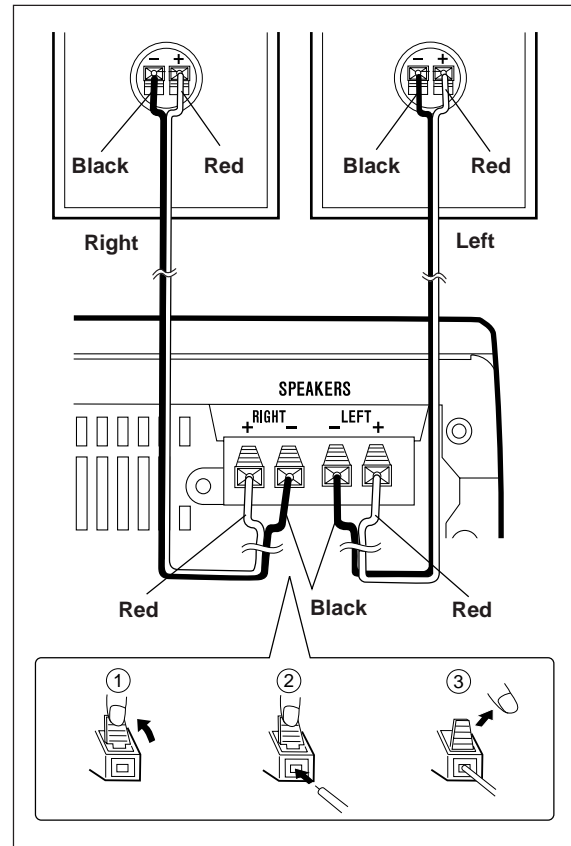

Connect each speaker wire to the SPEAKER terminals as shown.

Use speakers with an impedance of 6 ohms or more, since lower impedance speakers can damage the unit.

Caution:

- Before connecting the speakers to the unit, connect the speaker wires to the speakers first. Then, connect the speaker wire to the terminals on the unit.
- Connect the speakers to the main unit before you use the system. If the speakers are not connected before operation, the system may be damaged.

Notes:

- Connect the black wire to the minus (-) terminal, and the red wire to the plus (+) terminal.
- Do not mix the right channel and left channel wiring when connecting the speakers to the unit.
- Do not let bare speaker wires touch each other as this may damage the amplifier and/or speakers.



(Continued)

■ Removing the speaker grilles

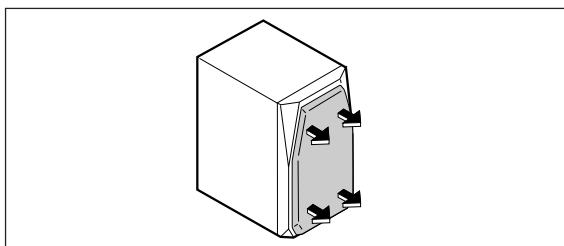

- 1 Remove the lower part of the speaker grille first.
- 2 Remove the upper part of the speaker grille.

Caution:

When the speaker grilles are removed, the speaker diaphragms are exposed. Make sure nothing comes into contact with the speaker diaphragms.

■ Speaker cushion

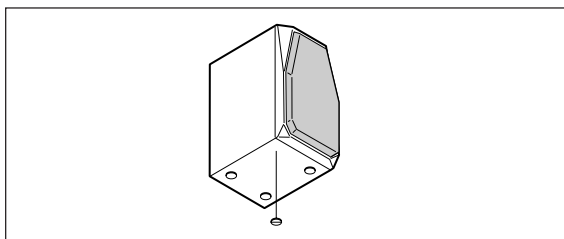

Attach the cushions to the bottom of the speaker to prevent it from sliding.

■ Placing the system

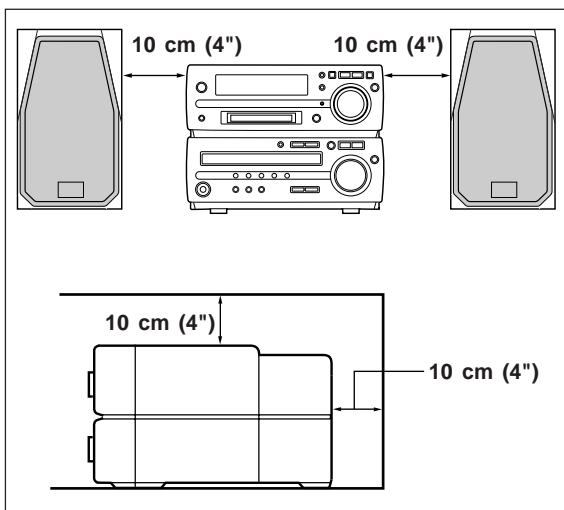

Be sure to keep space between the units for ventilation. Keep the top and the back of this unit at least 10 cm (4") away from the wall.

Note:

- Do not place the system or speakers near a television set as the magnetic fields produced may cause irregular colours to be displayed.

■ Connecting the AC power lead

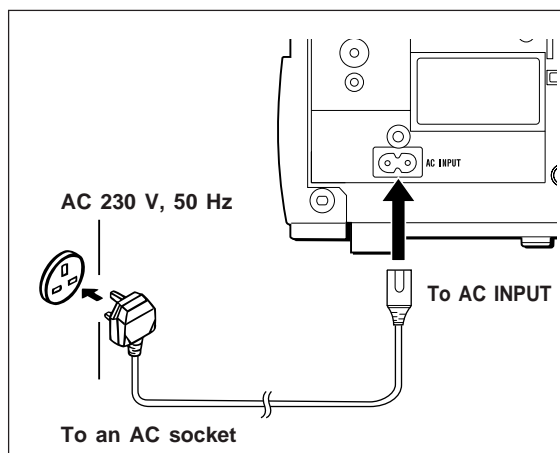

Connect the AC power lead to the AC INPUT socket, then connect its plug to an AC socket.

Notes:

- Unplug the AC power lead from the AC socket if the unit will not be in use for a prolonged period of time.
- Never use a power lead other than the one supplied. Use of a power lead other than the one supplied may cause an electric shock or fire.

■ Demo mode

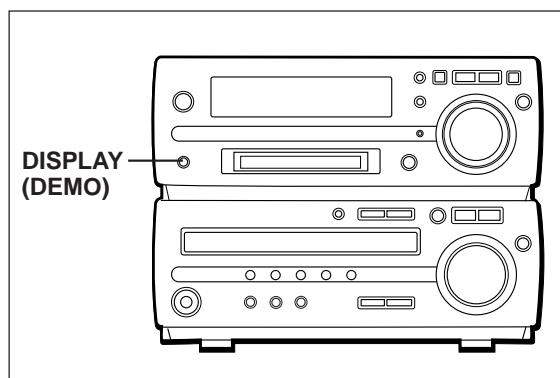

When the AC power lead is first connected, the unit will enter the demonstration mode and the words will scroll across the display continuously.

To cancel the demonstration mode:

When in the demonstration mode, press the DISPLAY (DEMO) button.

- The demonstration mode will be cancelled and the unit will be in the low power consumption mode.

Note:

- When the unit is in the low power consumption mode, the display will disappear.



(Continued)

■ Remote control

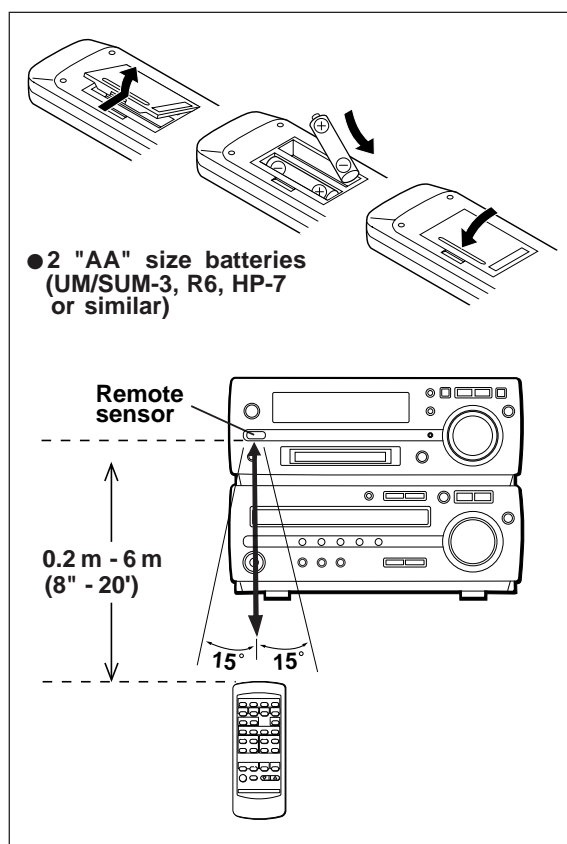

- When inserting or removing the batteries, push them toward the battery terminal.
- Installing the batteries incorrectly may cause the unit to malfunction.

Precautions for battery use:

- Insert the batteries according to the direction indicated in the battery compartment.
- Replace all old batteries with new ones at the same time.
- Do not mix old and new batteries.
- Remove the batteries if they are weak or if the unit will not be used for long periods of time. This will prevent potential damage due to battery leakage.

Caution:

Do not use rechargeable batteries (nickel-cadmium battery, etc.).

Notes concerning use:

- Replace the batteries if the operating distance is reduced or if the operation becomes erratic.
- Periodically clean the transmitter LED on the remote control and the sensor on the main unit with a soft cloth.
- Exposing the sensor on the main unit to strong light may interfere with operation. Change the lighting or the direction of the unit.
- Keep the remote control away from moisture, excessive heat, shock, and vibrations.

■ To change the brightness of the display

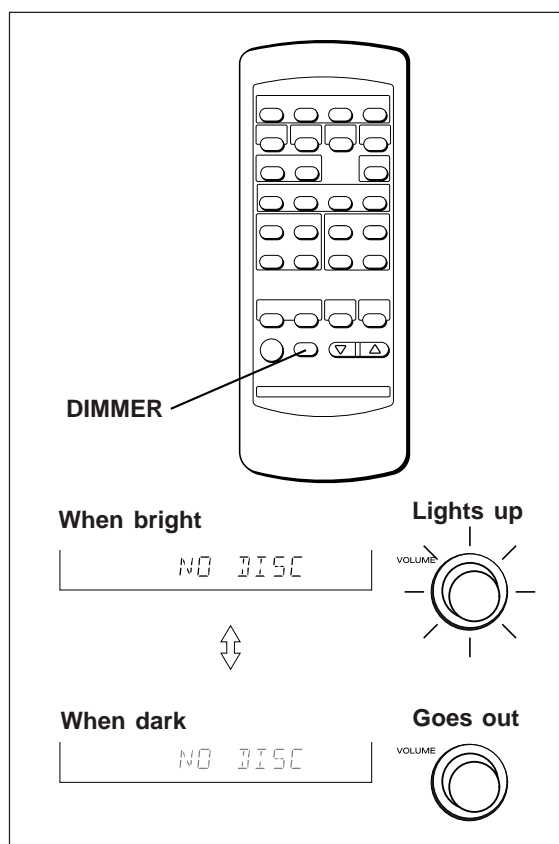

1 Press the ON/STAND-BY button to turn the power on.

2 Press the DIMMER button.

- The display will become dimmer and the light around the VOLUME control will go out.

To return to the original brightness:

Press the DIMMER button again.



SETTING THE CLOCK

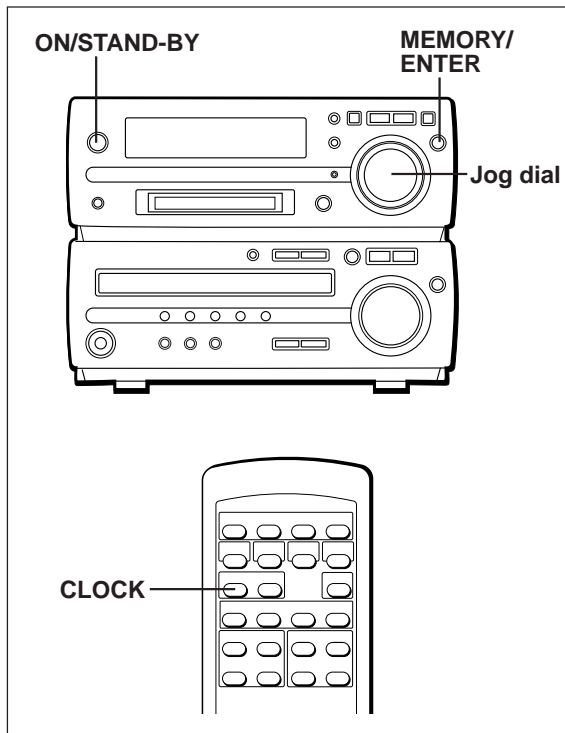

- In this example, the clock is set for the 24-hour (0:00) system.

1 Press the ON/STAND-BY button to turn the power on.

2 Press the CLOCK button.



3 Within 5 seconds, press the MEMORY/ENTER button.



4 Turn the jog dial to select the time display mode.

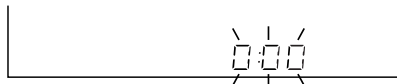

"0:00" →The 24-hour display will appear.
(0:00 - 23:59)

"12:00 AM" →The 12-hour display will appear.
(AM or PM 12:00 - 11:59)

"0:00 AM" →The 12-hour display will appear.
(AM or PM 0:00 - 11:59)

- Note that this can only be set when the unit is first installed or it has been reset (see page 48).

5 Press the MEMORY/ENTER button.



6 Adjust the hour by turning the jog dial.

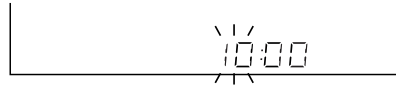

- When the jog dial is turned one click clockwise, the time will increase by 1 hour. When it is turned one click anti-clockwise, the time will decrease by 1 hour. Keep turning the jog dial to change the time continuously.
- When the 12-hour display is selected, "AM" will change automatically to "PM".

7 Press the MEMORY/ENTER button.

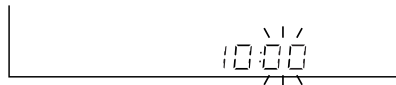

8 Adjust the minutes by turning the jog dial.

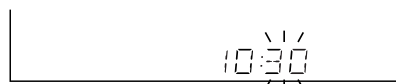

- When the jog dial is turned one click clockwise, the time will increase by 1 minute. When it is turned one click anti-clockwise, the time will decrease by 1 minute. Keep turning the jog dial to change the time continuously.
- The hour setting will not advance even if minutes advance from "59" to "00".

9 Press the MEMORY/ENTER button.

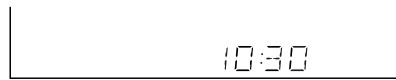

- The clock starts operating from "0" second. (Seconds are not displayed.)

To see the time display:

Press the CLOCK button.

- The time display will appear for about 5 seconds even in the stand-by mode.

Note:

- The "CLOCK" will appear at the push of the CLOCK button when the AC power supply is restored after a power failure occurs or after the AC power lead is disconnected. If this happens, follow the procedure below to change the clock time.

To change the clock time:

- 1 Press the CLOCK button.
- 2 Within 5 seconds, press the MEMORY/ENTER button.
- 3 Perform steps 6 - 9 above.

To change the time display mode:

- 1 Reset the microcomputer (see page 48).
- 2 Perform steps 2 - 9 above.



SOUND CONTROL

Volume

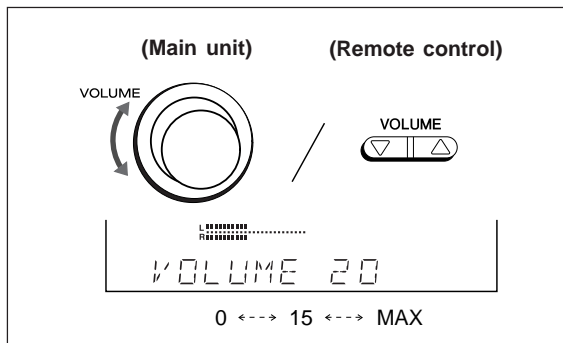

(Main unit operation)

When the **VOLUME** control is turned clockwise, the volume will increase. When it is turned anti-clockwise, the volume will decrease.

(Remote control operation)

Press the **VOLUME** Δ button to increase the volume and the **VOLUME** ∇ button to decrease the volume.

Servo Powered Volume:

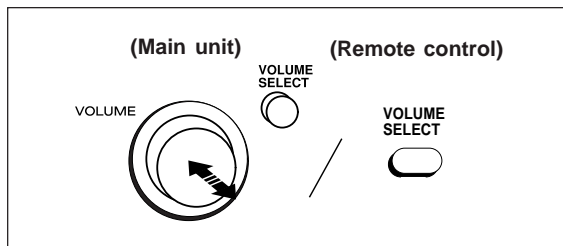

The **VOLUME** control automatically comes out when the power is turned on, and goes back when the unit is set to the stand-by mode.

● When the power is turned on, you can put the **VOLUME** control in and out by pressing the **VOLUME SELECT** button.

Note:

● Do not push in the **VOLUME** control forcibly with your finger.

Pre-programmed equalizer

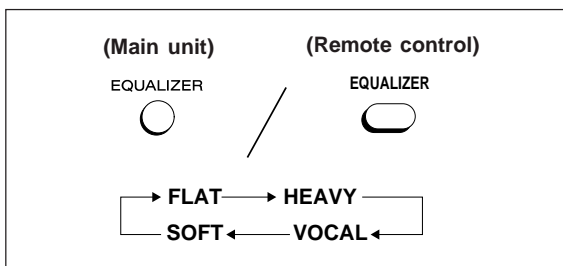

When the **EQUALIZER** button is pressed, the current mode setting will be displayed. To change to a different mode, press the **EQUALIZER** button repeatedly.

FLAT: The sound is not modified.

HEAVY: Bass and treble are emphasised.

VOCAL: Vocals (midrange tones) are emphasised.

SOFT: Treble is reduced.

Extra bass (X-BASS)

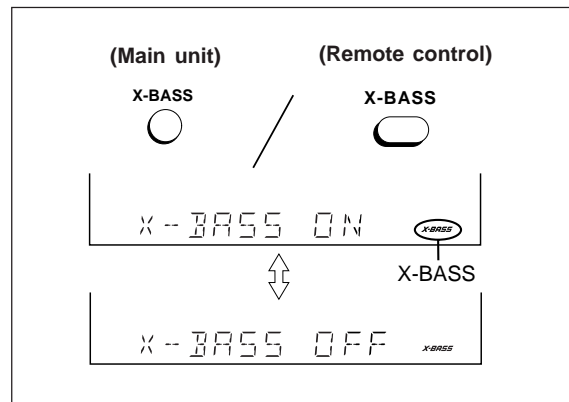

Press the **X-BASS** button to emphasise the bass region of the frequency spectrum.

● "X-BASS ON" will appear.

Press the **X-BASS** button again to cancel the extra bass mode.

● "X-BASS OFF" will appear.

Surround

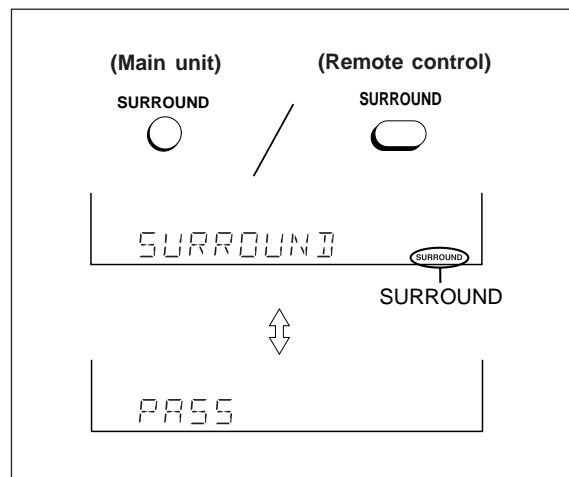

Press the **SURROUND** button to allow you to enjoy music that seems to surround you.

● "SURROUND" will appear.

Press the **SURROUND** button again to cancel the surround mode.

● "PASS" will appear.



COMPACT DISC OPERATION

■ CD playback

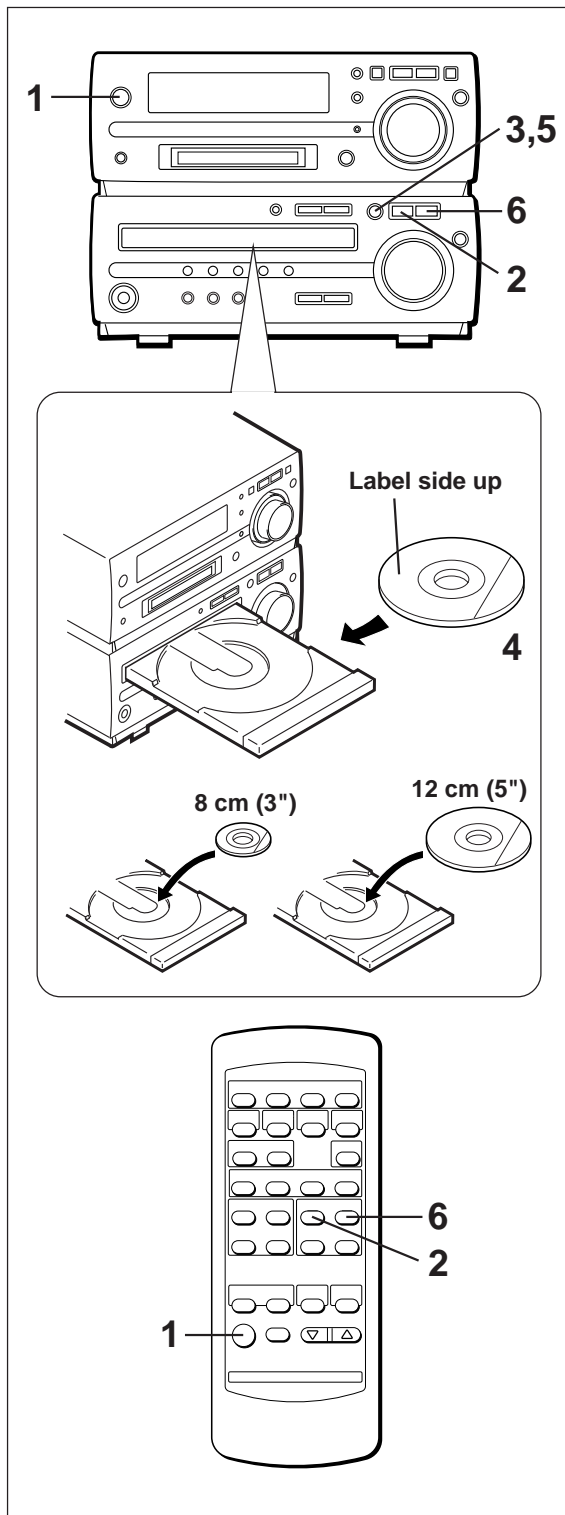

1 Press the ON/STAND-BY button to turn the power on.

2 Press the CD ■ button.

3 Press the ▲ button to open the disc tray.

4 Place the CD on the disc tray, label side up.

- Be sure to place 8 cm (3") CD in the middle of the disc tray.

5 Press the ▲ button to close the disc tray.

- The total number of tracks and the total playing time will be displayed.

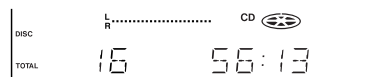

Total number of tracks Total playing time

6 Press the CD ►|| button to start playback from track 1.

- When the last track has been played back, the unit will stop automatically.

To interrupt playback:

Press the CD ►|| button.

- "||" will appear.
- Press the CD ►|| button again to resume playback from the same point.

To stop playback:

Press the CD ■ button.

To remove the CD.

Press the ▲ button.

After use:

Press the ON/STAND-BY button to enter the stand-by mode.

Caution:

- Do not carry the unit with a CD left in the disc tray. The disc may come loose inside the unit and it may be damaged or cause damage to the unit. This may also cause malfunctions.
- Do not push the disc tray whilst it is moving.
- If the power fails whilst the tray is open, wait until the power is restored.
- If the disc tray is stopped forcibly, "E-CD20" will appear in the display and the unit will not function. If this occurs, press the ON/STAND-BY button to enter the stand-by mode and then turn the power on again.
- Subjecting the unit to shock or vibration may cause mistracking.
- Playing certain CDs at a high volume may cause mistracking. In this case, listen at a lower volume.
- If TV or radio interference occurs during CD operation, move the unit away from the TV or radio.



MINIDISC OPERATION

■ MiniDisc playback

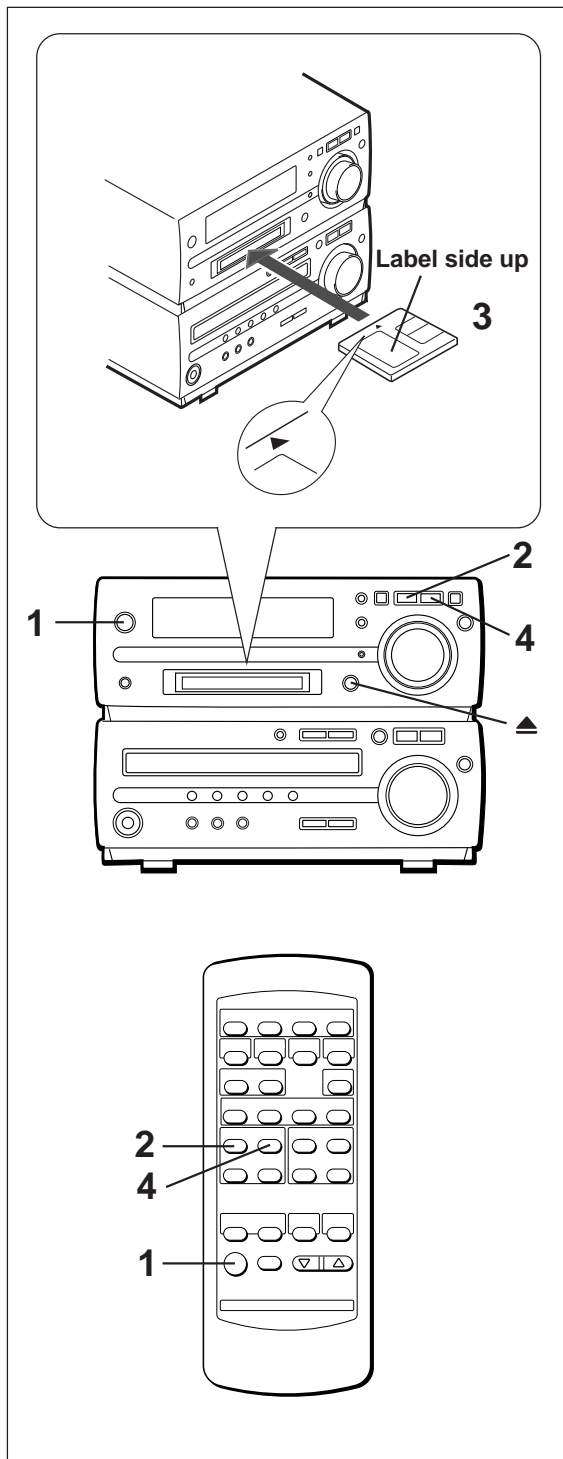

1 Press the ON/STAND-BY button to turn the power on.

2 Press the MD ■ button.

3 Load a MiniDisc in the direction indicated by the arrow on the MiniDisc, with the labelled side facing up.

- The disc name will be displayed only when it has been programmed.

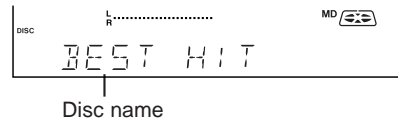

- The total number of tracks and the total playing time on the MiniDisc will be displayed.

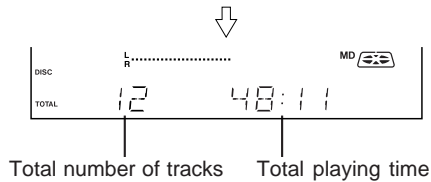

4 Press the MD ►|| button.

- If the MiniDisc has a track name, it will appear and scroll across the display. Then, the elapsed playing time will appear.
- If the MiniDisc has no track names, the elapsed playing time will appear.
- When the last track has been played back, the unit will stop automatically.

To interrupt playback:

Press the MD ►|| button.

- " || " will appear.
- Press the MD ►|| button again to resume playback from the same point.

To stop playback:

Press the MD ■ button.

To remove a MiniDisc:

Press the ▲ button.

Caution:

- **Do not carry the unit with a MiniDisc left in the MD compartment. The disc may come loose inside the unit and it may be damaged or cause damage to the unit. This may also cause malfunctions.**

- If TV or radio interference occurs when using the MiniDisc, move the unit away from the TV or radio.

- Although MiniDiscs will not normally skip due to vibration, you may hear skipping in the sound if there is continuous vibration.

If the volume is turned up too high, sound skipping may occur depending on the contents of the MiniDisc.

If this happens, turn the volume down and the skipping should stop.

- If an error message is displayed during MiniDisc operation, see "ERROR MESSAGES" on page 49.



CONVENIENT CD AND MINIDISC OPERATIONS

■ APSS (Auto Program Search System)

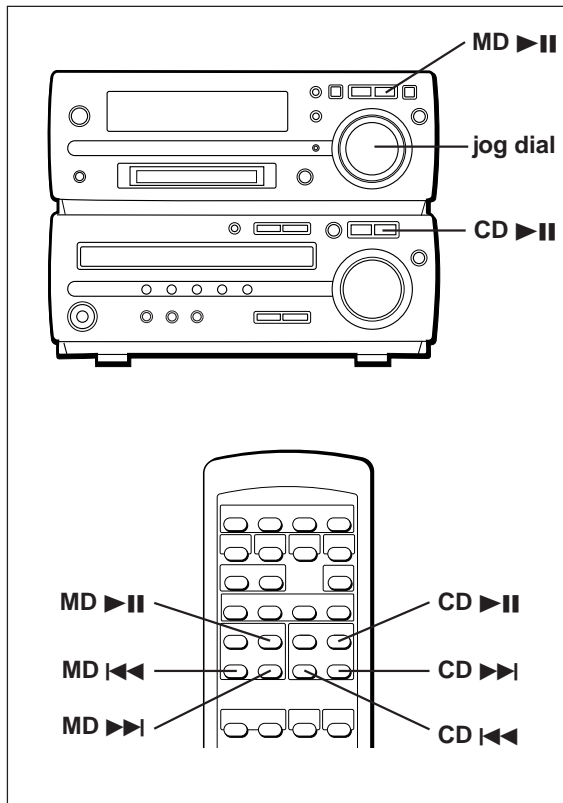

To listen again to the track being played:

(Main unit operation)

Turn the jog dial anti-clockwise during playback.

(Remote control operation)

Press the CD ◀◀ or MD ◀◀ button for less than 0.5 seconds during playback.

To move to the beginning of the next track:

(Main unit operation)

Turn the jog dial clockwise during playback.

(Remote control operation)

Press the CD ▶▶ or MD ▶▶ button for less than 0.5 seconds during playback.

- To skip a number of tracks at one time, turn the jog dial on the main unit or press the CD ◀◀ / ▶▶ or MD ◀◀ / ▶▶ button on the remote control repeatedly until the desired track number is shown.

- To start continuous playback from a desired track, select the track number by turning the jog dial on the main unit, or by pressing the CD ◀◀ / ▶▶ or MD ◀◀ / ▶▶ button on the remote control, whilst in the stop mode. Then, press the CD ►|| or MD ►|| button.

■ Cue and review

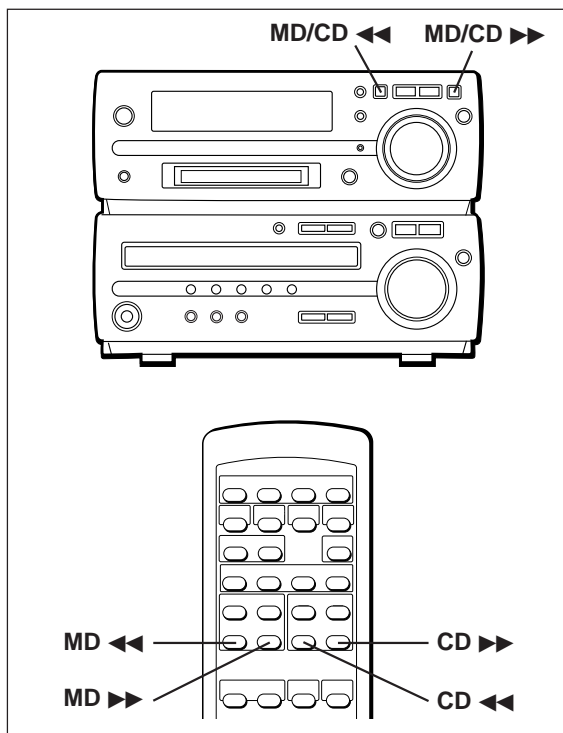

1 Load a disc and begin playback.

2 Hold the MD/CD ▶▶ button down for audible fast forward, and hold the MD/CD ◀◀ button down for audible fast reverse.

3 Normal playback will resume when the button is released.

Notes:

- When the end of the last track is reached, "END" will light, and the unit will pause.

If you want to listen to a portion of a track again, press the MD/CD ◀◀ button to return to the point in the track you want to listen to.

- If the beginning of the disc is reached whilst reviewing, playback will start automatically.

To search very quickly:

When fast forward or fast reverse is used whilst in the pause mode, the playback point will move more quickly than when using audible fast forward or audible fast reverse playback.

- In this mode, no sound is heard. Therefore, you should refer to the time display.

- When you lift your finger, the unit will re-enter the pause mode.



(Continued)

■ APMS (Automatic Programmable Music Selector)

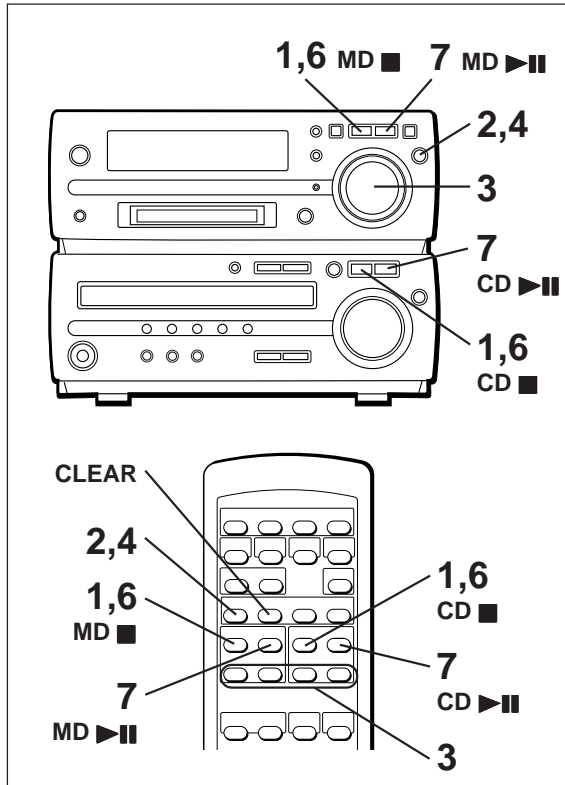

- 1** (CD operation)
Press the **CD** button.
(MiniDisc operation)
Press the **MD** button.

- 2** Press the **MEMORY/ENTER** button.



- 3** Turn the jog dial or press the **CD** or **MD** button.

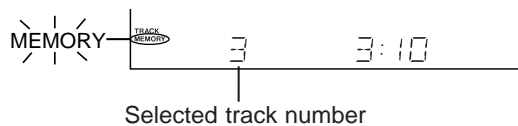

- 4** Press the **MEMORY/ENTER** button.

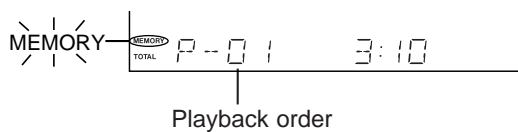

- 5** Repeat steps 3 and 4 for any other tracks. Up to 20 tracks (P-20) can be programmed.

- 6** (CD operation)
Press the **CD** button.
(MiniDisc operation)
Press the **MD** button.



Total number of tracks Total playing time

- 7** (CD operation)
Press the **CD** button to start playback of the programmed selections.

- (MD operation)
Press the **MD** button to start playback of the programmed selections.

- After all of the programmed tracks have finished playback, the unit will automatically stop.

To clear the programmed selections:

Press the **CLEAR** button whilst the "MEMORY" indicator is flashing.

- Each time the button is pressed, one track will be cleared, beginning with the last track programmed.

To cancel the APMS:

Whilst the unit is stopped in the APMS mode, press the **CLEAR** button to turn off the "MEMORY" display.

- The programme contents will be erased.
- When you open the disc tray or eject a MiniDisc, the APMS mode will be cancelled.

To check which tracks are programmed:

Whilst the unit is stopped in the APMS mode, turn the jog dial or press the **CD** or **MD** button.



Track number Playback order

Adding tracks to the programme:

If a programme has been previously stored, the "MEMORY" indicator will be displayed. Then follow steps 2 - 6 to add additional tracks. The new tracks will be stored after the last track of the original programme.

Notes:

- It is not possible to insert an additional track between programmed tracks that have already been entered.
- Programming and cancelling are not possible during playback or in the pause mode.



(Continued)

Repeat and random play

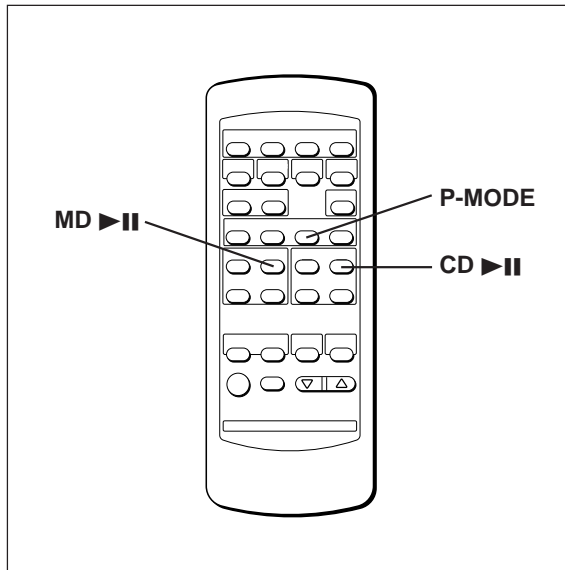

1 Select the desired programme source, CD or MiniDisc.

2 Press the P-MODE button.

- Each time this button is pressed, the mode will change in the following order:

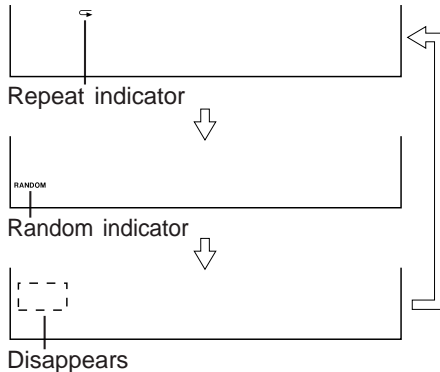

3 Press the CD or MD button to start playback.

Repeat play

After the last track has been played, playback will return to the first track and begin again.

Random play

When the CD or MD button is pressed, all of the tracks will be played at random, and then playback will stop. (The same track will not be played back twice.)

To cancel repeat or random play:

Press the P-MODE button until the " " or "RANDOM" display disappears.

To repeat playback of selected tracks:

Enter the programme for the tracks you want and start repeat play.

You can programme a single track and play it repeatedly (refer to page 14).

Notes:

- If you press the CD or MD button during random play, you can move to the next track. On the other hand, the CD or MD button does not allow you to move to the previous track. The beginning of the track being played will be located.
- During APMS play, random play is not possible.
- When random or repeat play is selected during CD or MiniDisc playback, random or repeat play will start at that point.
- When using repeat play, be sure to press the CD or MD button after you have finished listening. Otherwise, the disc will play continuously.



(Continued)

■ Switching the time display

Each time the TIME button is pressed during playback or when in the pause mode, the display will change.

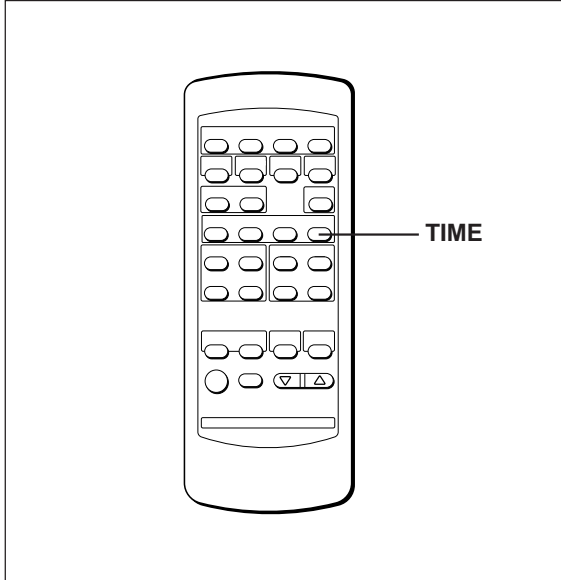

- 1** The elapsed playing time for current track will be displayed.



- 2** The remaining playing time for the current track will be displayed.

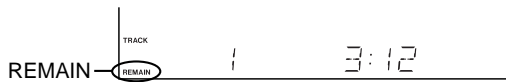

- 3** The total remaining playing time for the disc from the point being played at that time will be displayed.

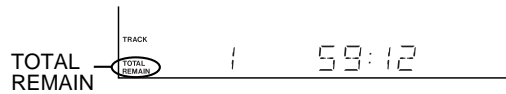

Notes:

- During random play, the total remaining playing time cannot be displayed.
- Depending on a CD or MiniDisc to be played, the playing time display may not match the total playing time which is indicated on the CD or MiniDisc jacket, as the time between the tracks is not included.

■ Changing the display during MiniDisc playback

Each time the DISPLAY button is pressed during playback or when in the pause mode, the display will change as described below.

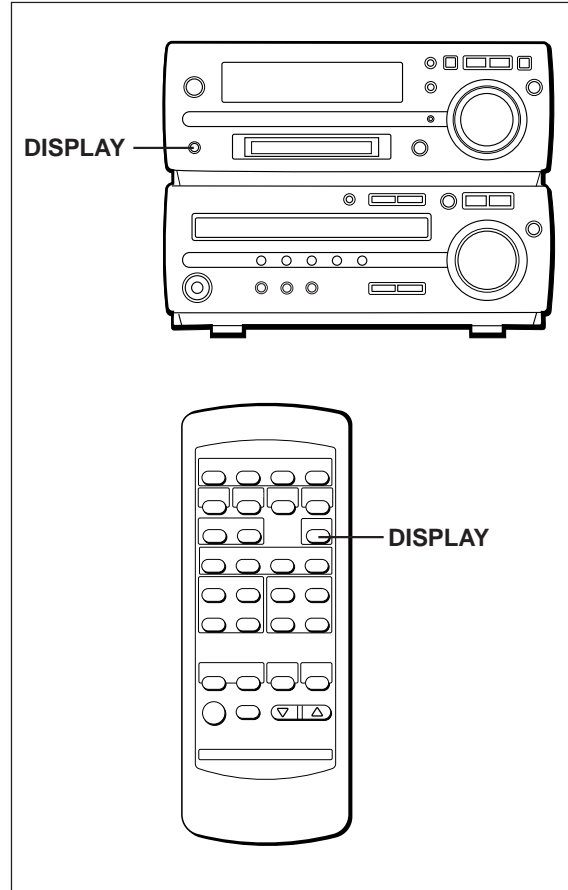

- 1** The track name will be displayed.



- When the MiniDisc does not have a track name, this display does not appear.

- 2** The total number of tracks and the remaining recording time will be displayed.

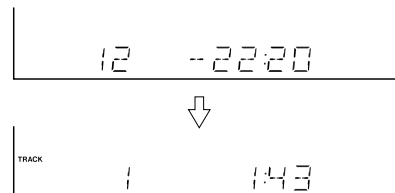



RADIO OPERATION

Tuning

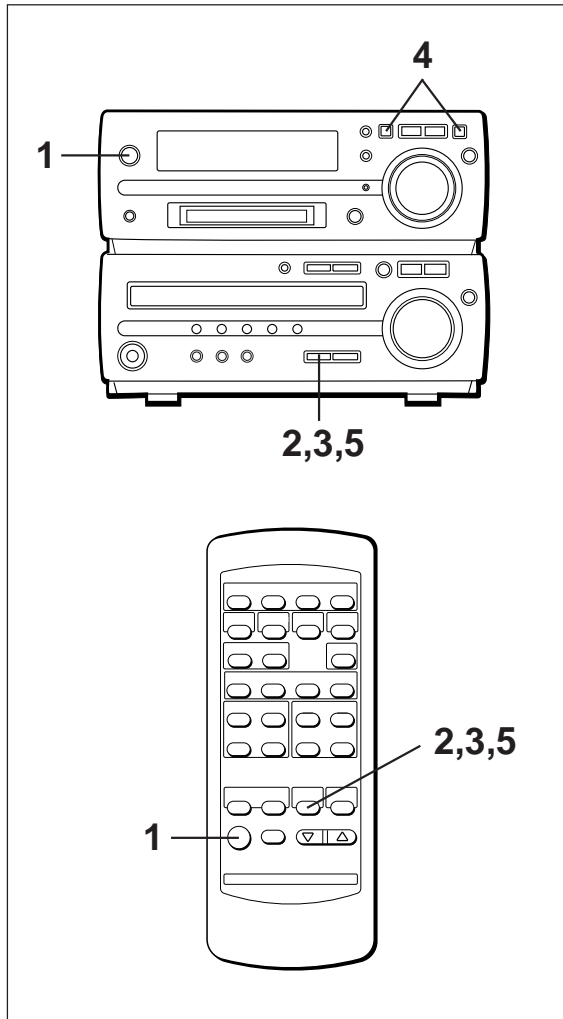

- 1** Press the ON/STAND-BY button to turn the power on.
- 2** Press the TUNER (BAND) button.
- 3** Press the TUNER (BAND) button to select the desired frequency band. (FM ST, FM or AM)

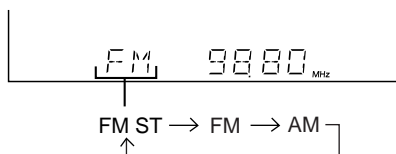

- 4** Press the TUNING (✓ or ^) button to tune into the desired station.

Manual tuning:

Press the TUNING (✓ or ^) button as many times as required to adjust the frequency shown on the display to the frequency of the desired station.

Auto tuning:

When the TUNING (✓ or ^) button is pressed for more than 0.5 seconds, scanning will start automatically and the tuner will stop at the first receivable broadcast station.

- When radio interference occurs during auto scan tuning, auto scan tuning may stop automatically at that point.
- If a weak station signal is found during auto scan tuning, the station will be skipped.
- To stop the auto tuning, press the TUNING (✓ or ^) button again.
- When an RDS (Radio Data System) station is tuned in, the frequency will be displayed first, and then the RDS indicator will light. Finally, the station name will appear.

- 5** To receive an FM stereo transmission, press the TUNER (BAND) button so that the "ST" indicator on the display lights up.

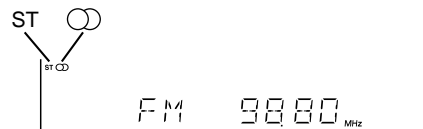

- "∞" will appear when an FM broadcast is in stereo.
- If the FM reception is weak, press the TUNER (BAND) button so that the "ST" indicator goes out.
- The reception changes to monaural, the sound becomes clearer.

After use:

Press the ON/STAND-BY button to enter the stand-by mode.

Notes:

- The last station tuned in will be recalled, even after changing the tuning band or the function, or after switching the unit to the stand-by mode.
- If the unit's tuner interferes with the reception of a nearby TV or radio, move the unit as far away from these items as possible.



(Continued)

■ Preset tuning

You can store up to 40 stations in memory (40 stations consisting of any combination of AM and FM stations you like) and recall them.

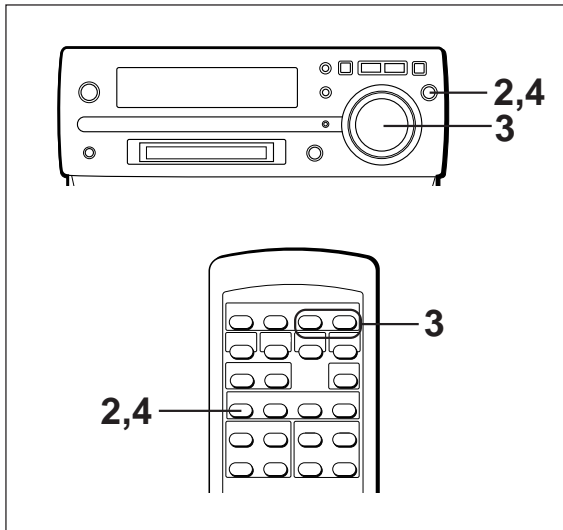

To enter stations into memory:

- 1 Perform steps 1 - 5 in the "Tuning" section.
- 2 Press the MEMORY/ENTER button.

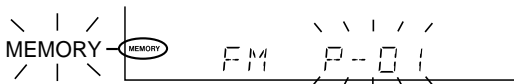

- 3 Within 5 seconds, turn the jog dial or press the PRESET (∨ or ∧) button to make the preset channel number flash in the display.



- Store the stations in memory, in order, starting with preset channel 1. When * is displayed, a station has already been stored in this preset number memory.

- 4 Within 5 seconds, press the MEMORY/ENTER button to store that station in the selected station preset number memory.

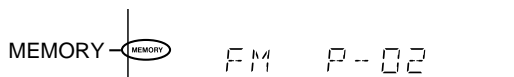

- If the "MEMORY" and preset number indicators go out before the station is memorised, repeat the operation from step 2.

- 5 Repeat steps 1 - 4 to set other stations, or to change a preset station.

- When a new station is stored in the selected station preset number memory, the contents previously memorised will be erased.
- To store an RDS station in memory, perform steps 2 - 4 whilst the RDS station name is being displayed.

To recall a memorised station:

Turn the jog dial or press the PRESET (∨ or ∧) button for less than 0.5 seconds to select the desired station.

- The stations (preset channel number, frequency and frequency band) which have been stored in memory will appear in the display in numerical order, irrespective of the frequency bands.

Backup function:

The backup function protects all station presets for a few hours should there be a power failure or the AC power lead is removed from the AC socket.

■ Preset memory scan

The stations saved in the preset memory can be scanned automatically.

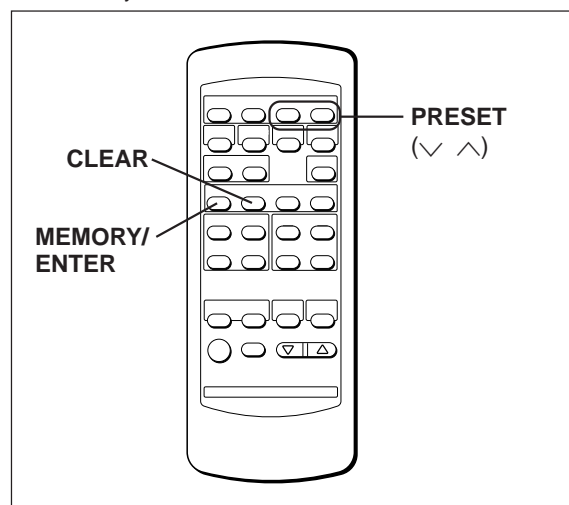

- 1 To scan the preset stations, press the PRESET (∨ or ∧) button for more than 0.5 seconds.

- The station preset number will flash and the programmed stations will be tuned in sequentially, for 5 seconds each.

- 2 Press the PRESET (∨ or ∧) button again to stop the memory scan at the desired station.

Note:

When the preset memory does not have any stations stored in it, the preset memory scan will not function.

To erase the memorised station:

- 1 Recall the memorised station to erase by turning the jog dial or pressing the PRESET (∨ or ∧) button.

- 2 Press the CLEAR button.

- "MEMORY" and preset number will flash.

- 3 Within 5 seconds, press the MEMORY/ENTER button.

- 4 Repeat steps 1-3 to erase other memorised stations.

To erase all memorised stations:

When the unit is in the stand-by mode, hold down the TUNER (BAND) and the MD ■ buttons, and then press the ON/STAND-BY button.

- "PRESET CLR" will appear.



RDS (Radio Data System) OPERATION

RDS is a broadcasting service which a growing number of FM stations are now providing. It allows these FM stations to send additional signals along with their regular programme signals. For example, the stations send their station names, and information about what type of programme they broadcast, such as sports or music, etc.

When tuned to an FM station which provides the RDS service, the RDS will appear and the station name is displayed. The TP (Traffic Programme) will appear on the display when the received broadcast carries traffic announcements, and the TA (Traffic Announcement) will appear whilst a traffic announcement is being broadcast.

EON will appear whilst the EON (Enhanced Other Networks information) data is being broadcast.

The PTYI (Dynamic PTY Indicator) will appear whilst the Dynamic PTY station is being received.

RT (Radio Text) will appear whilst the Radio text data is being broadcast.

Note:

When the TP and TA appear at the same time, an announcement is being made.

When only the TA appears, an announcement is not being made (see page 30).

Information provided by RDS

With this unit, you can display five types of RDS service. To show them in the display, press the DISPLAY MODE button.

Each time you press the DISPLAY MODE button, the display will change to show the following information (see page 25).

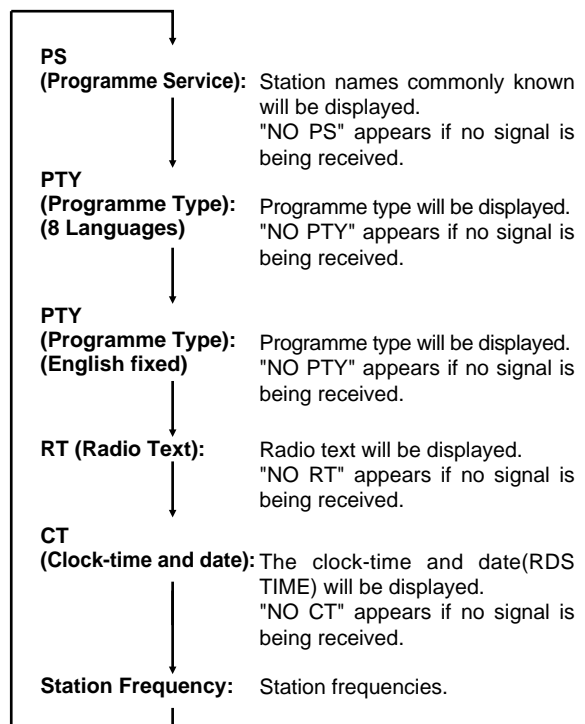
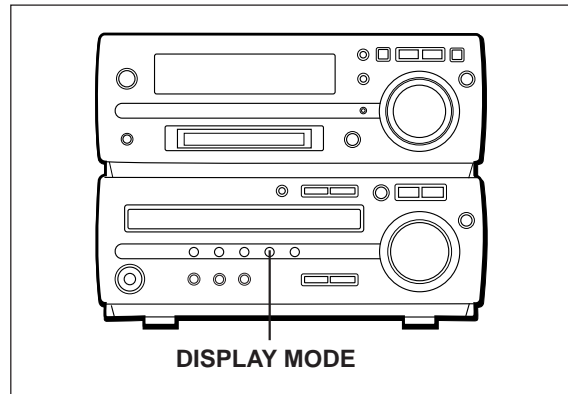



(Continued)

Descriptions of the PTY (Programme Type) codes, TP (Traffic Programme) and TA (Traffic Announcement)

With this unit, you can search for and receive the following PTY, TP and TA signals.

- NEWS:** Short accounts of facts, events and publicly expressed views, reportage and actuality.
- AFFAIRS:** Topical programme expanding or enlarging upon the news, generally in different presentation style or concept, including debate, or analysis.
- INFO:** Programmes whose purpose is to impart advice in the widest sense.
- SPORT:** Programme concerned with any aspect of sport.
- EDUCATE:** Programme intended primarily to educate, of which the formal element is fundamental.
- DRAMA:** All radio plays and serials.
- CULTURE:** Programmes concerned with any aspect of national or regional culture, including language, theatre, etc.
- SCIENCE:** Programmes about the natural sciences and technology.
- VARIED:** Used for mainly speech-based programmes usually of light-entertainment nature, not covered by other categories. Examples include: quizzes, panel games, personality interviews.
- POP M:** Commercial music, which would generally be considered to be of current popular appeal, often featuring in current or recent record sales charts.
- ROCK M:** Contemporary modern music, usually written and performed by young musicians.
- EASY M:** Current contemporary music considered to be "easy-listening", as opposed to Pop, Rock or Classical, or one of the specialized music styles, Jazz, Folk or Country. Music in this category is often but not always, vocal, and usually of short duration.
- LIGHT M:** Classical Musical for general, rather than specialist appreciation. Examples of music in this category are instrumental music, and vocal or choral works.
- CLASSICS:** Performances of major orchestral works, symphonies, chamber music, etc., and including Grand Opera.
- OTHER M:** Musical styles not fitting into any of the other categories. Particularly used for specialist music of which Rhythm & Blues and Reggae are examples.
- WEATHER:** Weather reports and forecasts and Meteorological information.
- FINANCE:** Stock Market reports, commerce, trading, etc.
- CHILDREN:** For programmes targeted at a young audience, primarily for entertainment and interest, rather than where the objective is to educate.

- SOCIAL:** Programmes about people and things that influence them individually or in groups. Includes: sociology, history, geography, psychology and society.
- RELIGION:** Any aspect of beliefs and faiths, involving a God or Gods, the nature of existence and ethics.
- PHONE IN:** Involving members of the public expressing their views either by phone or at a public forum.
- TRAVEL:** Features and programmes concerned with travel to near and far destinations, package tours and travel ideas and opportunities. Not for use for Announcements about problems, delays, or roadworks affecting immediate travel where TP/TA should be used.
- LEISURE:** Programmes concerned with recreational activities in which the listener might participate. Examples include, Gardening, Fishing, Antique collecting, Cooking, Food & Wine, etc.
- JAZZ:** Polyphonic, syncopated music characterised by improvisation.
- COUNTRY:** Songs which originate from, or continue the musical tradition of the American Southern States. Characterised by a straightforward melody and narrative story line.
- NATION M:** Current Popular Music of the Nation or Region in that country's language, as opposed to International 'Pop' which is usually US or UK inspired and in English.
- OLDIES:** Music from the so-called "golden age" of popular music.
- FOLK M:** Music which has its roots in the musical culture of a particular nation, usually played on acoustic instruments. The narrative or story may be based on historical events of the people.
- DOCUMENT:** Programme concerned with factual matters, presented in an investigative style.
- TEST:** Broadcast when testing emergency broadcast equipment or receivers.
- ALARM !:** Emergency announcement made under exceptional circumstances to give warning of events causing danger of general nature.
- NONE:** No programme type (receive only).
- TP:** Broadcasts which carry traffic announcements.
- TA:** Traffic announcements are being broadcast at present.

Note:

- When the unit is in the EON stand-by mode and a programme is selected, the unit will display "TI" instead of "TA".



(Continued)

■ ASPM (Auto Station Program Memory)

It is recommended that you store stations in memory using ASPM.

(This memory can be used for PTY searches, station select and EON switching.)

When the ASPM button is pressed whilst tuned to the FM band, the RDS (Radio Data System) function will automatically search for new RDS stations. Up to 40 stations can be stored in memory.

(If you have already stored some stations in memory, the number of new stations you can store will be less.)

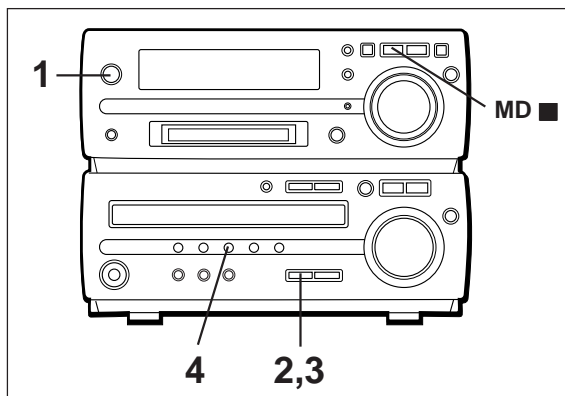

1 Press the ON/STAND-BY button to turn the power on.

2 Press the TUNER (BAND) button.

3 Press the TUNER (BAND) button to select the FM ST or FM band.

4 Press and hold down the ASPM button for at least 3 seconds.

① After "ASPM" has flashed for about 4 seconds, scanning will start (87.50 - 108.00 MHz).

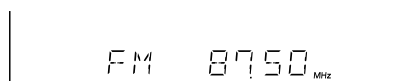
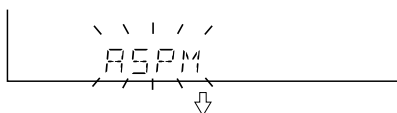

② When an RDS station is found, the RDS will appear for a short time and the station will be stored in memory.



③ After scanning, the number of stations that have been automatically stored in memory will be displayed for 4 seconds, and then "END" will appear for 4 seconds.

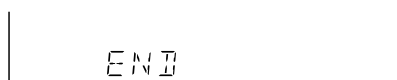

To stop the ASPM operation before it is complete:

Press the ASPM button whilst it is scanning for stations.

- The stations that have already been stored in memory will be kept there.

To erase all of the contents of preset memory:

The unit is in the stand-by mode.

Hold down the TUNER (BAND) button and the MD ■ button, and then press the ON/STAND-BY button.

- "PRESET CLR" will appear.
- After performing this operation, all of the preset memory information will be erased.

Notes:

- Only RDS stations will be stored in memory.
- If the same station is broadcasting on different frequencies, the transmission with the strongest broadcast frequency will be stored in memory.
- Any station which has the same frequency as the one which has been already stored in memory will not be stored again.
- The ASPM operation can be repeated until "END" appears.
- If a 40th station is stored in memory during a scan, the scanning will stop at that station. The number of stations and "END" will each be displayed for 4 seconds.
- If no stations have been stored in memory, "END" will flash for about 4 seconds.
- If 40 stations have already been stored in memory and the ASPM button is pressed, "END" will appear immediately and the scan will be aborted.
If you want to redo the ASPM operation from the beginning, erase the preset memory, and then perform steps 1 - 4.
- If the RDS station broadcast signals are very weak, station names may not be stored in memory.



(Continued)

■ To specify station names and select stations manually (station select)

You can select a desired station by specifying the station name (BBC R1, BBC R2, etc.) from among the stations that have been stored in memory. (ASPM is convenient for storing stations in memory.) Before starting this operation, you must store one or more station names in memory.

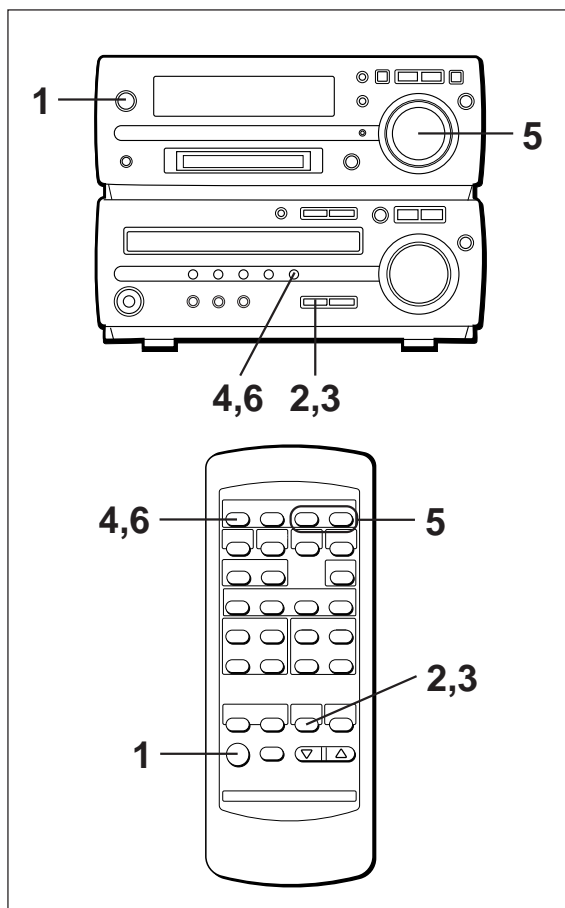

- 1 Press the ON/STAND-BY button to turn the power on.
- 2 Press the TUNER (BAND) button.
- 3 Press the TUNER (BAND) button to select the FM ST or FM band.
- 4 Press the STATION button.

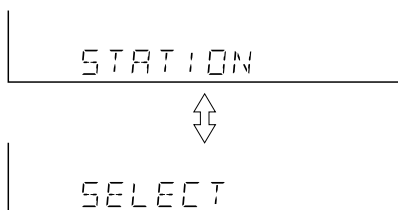

- "STATION" and "SELECT" will appear alternately for about 6 seconds.

- 5 Within 6 seconds, turn the jog dial or press the PRE-SET (∨ or ∧) button to select a desired station name you want.

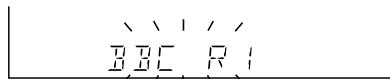

- Each time the button is pressed, the station name will appear. If the button is held down for more than 0.5 seconds, the station name will continuously change.

- 6 Whilst the selected station name is flashing (within 6 seconds), press the STATION button again.

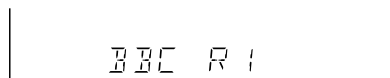
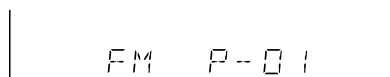

- After the selected station name has been lit for 1 second, the preset station which corresponds to the selected station name will be recalled.

To cancel the station select operation:

Press the STATION button whilst "STATION" and "SELECT" appear alternately.



(Continued)

To store a station name again, if the wrong name was stored in memory by mistake:

When you store station names in memory using the ASPM function, the correct station names may not actually be stored if there is lots of noise or if the RDS station signal is too weak. In this case, try storing station names in memory using the following procedure.

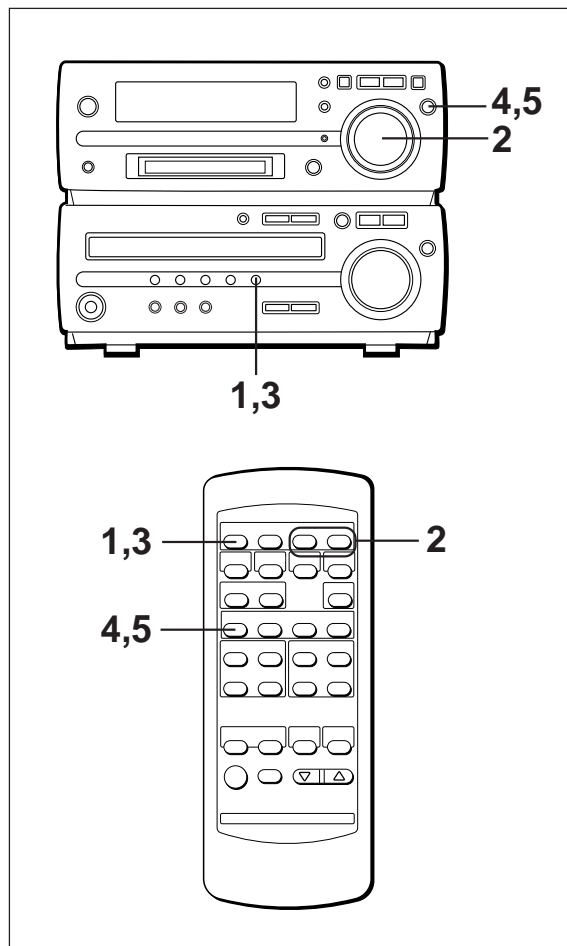

Notes:

- When there are no station names stored in memory, you cannot use this function. In this case, when the STATION button is pressed, "NOTHING" will flash for 5 seconds, and the unit will return to the original display.
- This function can only be used when the FM band has been selected.
- The same station name can be stored in different preset channels. Therefore, when you are choosing a station name from the presets, the same station name may be encountered more than once.
- In a certain area or during certain time periods, the station names selected using the station select function may temporarily be different from the name of the station you are actually receiving.

- 1** Press the STATION button.
- 2** Within 6 seconds, turn the jog dial or press the PRESET (∨ or ∧) button to check whether the station names are correct.
- 3** If you find a station name that is wrong, press the STATION button again within 6 seconds to recall the preset station, which corresponds to the station name.
- 4** After the preset station has been received and the correct station name has been displayed, press the MEMORY/ENTER button.
- 5** Within 5 seconds, press the MEMORY/ENTER button again whilst the preset channel number is flashing.
 - The new station name has been stored in memory correctly.



(Continued)

■ To recall stations that have been stored in memory (PTY search)

You can search a desired station by specifying the programme type (news, sports, traffic programme, etc. ... see pages 19-20) from among the stations that have been stored in memory. (ASPM is convenient for storing stations in memory.)

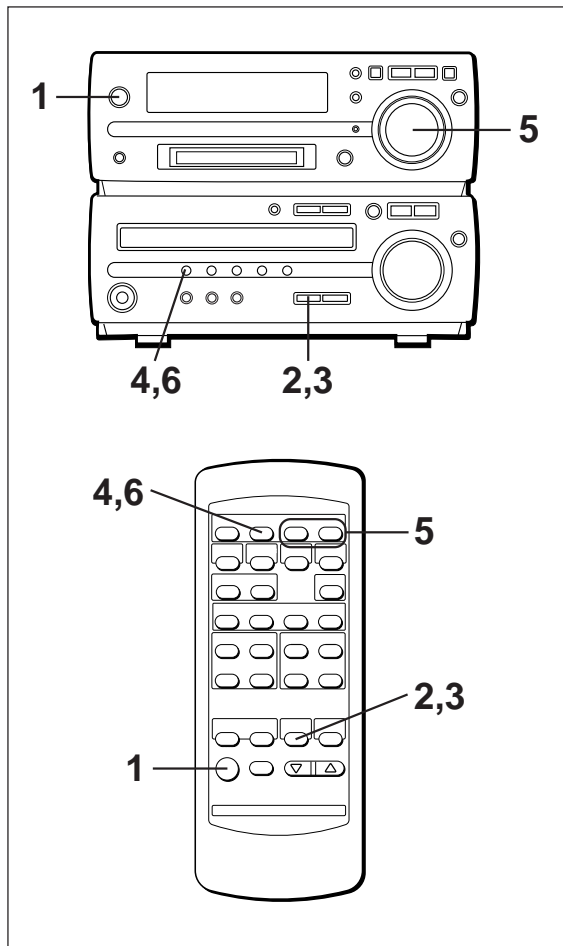

1 Press the ON/STAND-BY button to turn the power on.

2 Press the TUNER (BAND) button.

3 Press the TUNER (BAND) button to select the FM ST or FM band.

4 Press the PTY.TI SEARCH (PTY.TI) button.

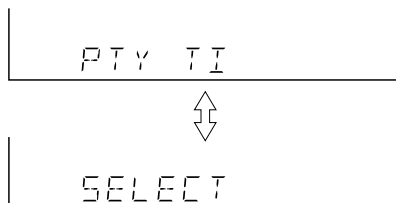

- "PTY TI" and "SELECT" will appear alternately for about 6 seconds.

5 Within 6 seconds, turn the jog dial or press the PRE-SET (✓ or ^) button to select the programme type you want.

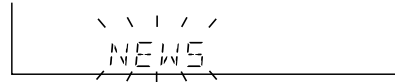

- Each time the button is pressed, the programme type will appear. If the button is held down for more than 0.5 seconds, the programme type will appear continuously.

6 Whilst the selected programme type is flashing (within 4 seconds), press the PTY.TI SEARCH (PTY.TI) button again.



- After the name of the selected programme type has been lit for 2 seconds, "SEARCH" will appear, and the search operation will start.

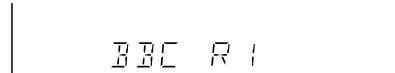
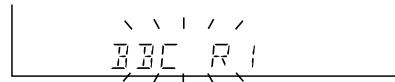
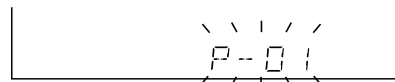

Note:

If the display has stopped flashing, start again from step 4. If the unit finds out a desired programme type you want, corresponding channel number will flash for about 3 seconds, and then the station name will flash for 7 seconds, and then remains lit.

- If you want to listen to the same programmed type of another station, press the PTY.TI SEARCH (PTY.TI) button whilst the channel number or station name is flashing. The unit will look for the next station.

Note:

- If no station of the programme type you want can be found, "NOT FOUND" will appear for 4 seconds.

★ If you have selected the traffic programme:

If you select traffic programme (TP) as the programme type in step 5, to receive only radio stations which broadcast traffic programmes, the TP will appear. (However, this does not necessarily mean that you will hear any traffic announcements at that time.)

When a traffic announcement is actually being made, the TA will appear.

(When both the TP and TA appear, an announcement will be made.)





(Continued)

■ To switch the RDS display

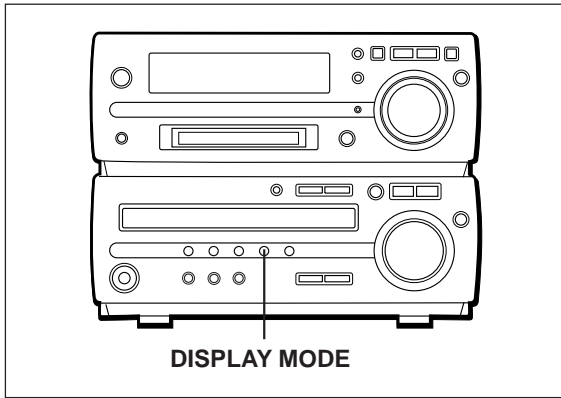

Each time the DISPLAY MODE button is pressed whilst an FM station is tuned in, the display will switch as follows:

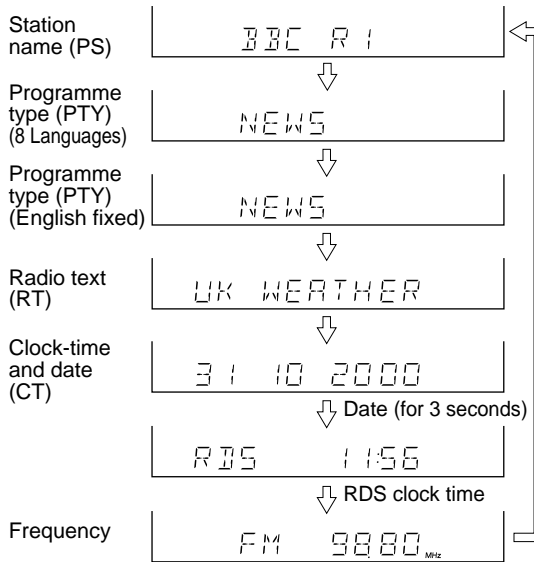

When the station you are tuning in is not an RDS station or even if it is an RDS station but it is very weak signal, the display will change in the following order:

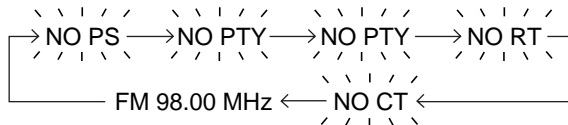

■ Notes for Radio text

- The radio text for 10 characters will be displayed steadily for 4 seconds and then it will scroll across the display.
- If you tune into a station which is not broadcasting any radio text, even if it is an RDS station, "NO RT" will be displayed when you switch to the radio text position.
- Whilst radio text data is being received or when the text contents change, "RT" will be displayed.
- Whilst radio text data is being received, RT indicator lights up.

■ Notes for PTY Languages

When you press the DISPLAY MODE button after PS (Program Service), PTY Languages mode will be selected. In this mode, PTY names will be displayed automatically in the local language where an RDS station is located. Eight languages (including English) are available.

If you want to display PTY names in English only, switch to the next mode, PTY English.

Notes:

- If you tune into an RDS station which is not broadcasting any data determining the PTY language, the PTY name will be displayed in English, not a local PTY language.
- A PTY name may be displayed in English for a short time, until a signal determining the local PTY language is received.
- PTY languages are also used for PTY-Search and EON-PTY operation at any DISPLAY MODE except PTY English.

■ Notes for RDS operation

If any of the following events occur, it does not mean that the unit is faulty.

- "PS", "NO PS" and a station name appear alternately, and the unit does not operate properly.
- If a particular station is not broadcasting properly or a station is conducting tests, the RDS reception function may not work properly.
- When you receive an RDS station whose signal is too weak, information like the station name may not be displayed, even if "RDS" is lit.

Notes:

- "NO PS", "NO PTY", "NO RT" or "NO CT" will flash for about 5 seconds, and then the frequency will be displayed.
- The display can only be switched whilst tuned to the FM band.



(Continued)

■ To set the internal clock by the RDS TIME signal

You can set the internal clock using the RDS time signal (RDS CT data).

This is useful because it allows the internal clock to be set automatically from the RDS time signal being broadcast by an RDS station.

- Before setting the internal clock from the RDS time signal, it is necessary for you to have selected and set one of the three internal clock display modes, as shown on 9 page. If no display mode has been set, the clock display will default to the 24-hour display mode (0:00 - 23:59).

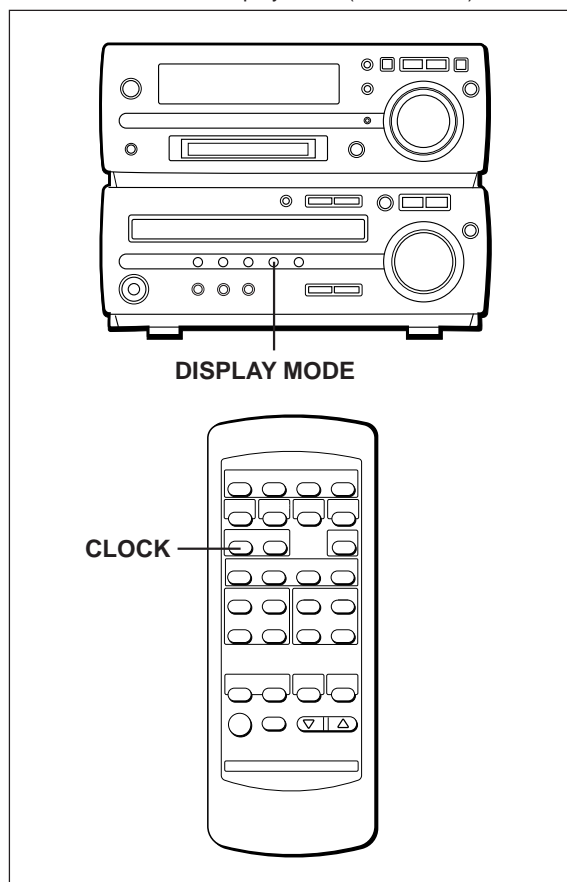

1 Tune in the desired RDS station (when its station name is being displayed).

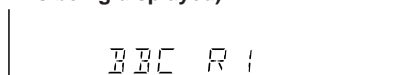

2 Press the DISPLAY MODE button to select CT.

(Display example; If it is 11:56 on October 31, 2000)

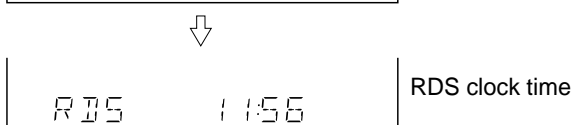

3 Whilst RDS time is being displayed, press and hold down the CLOCK button for at least 3 seconds.

(Display example; If it is 11:50)



or



- "RDS TIME" and "WAITING" will appear alternately. Wait until "COMPLETE" appears. (It will appear in less than 60 seconds.)

4 After the internal clock has been set from the RDS time signal, "COMPLETE" will be displayed for 3 seconds. Then the updated internal clock time (that has been set according to the RDS time) will be displayed.

- Press the CLOCK button to check whether the internal clock is displaying the same time as the RDS clock.

Notes:

- When the CLOCK button is pressed whilst the RDS time is being displayed, the RDS clock and the internal clock can be displayed alternately, which allows you to compare the time shown.

If you have not yet set the clock display mode, "CLOCK" will appear in the internal clock time display.

- Whilst "RDS TIME" and "WAITING" are being displayed alternately:

If you press the CLOCK button, you will cancel the internal clock setting operation.

If you press any other button to interrupt the alternating display, the internal clock setting operation will be cancelled.

However, if "VOLUME", "X-BASS", "FLAT", "HEAVY", "VOCAL", "SOFT" or "SURROUND" is being displayed, the internal clock setting operation will not be cancelled, even if you press another button.

- When you are using the internal clock as a timer, you cannot set the internal clock. If you press and hold the CLOCK button for at least 3 seconds, "CAN'T SET" will be displayed.
- Whilst "NO CT" or "CT" is being displayed, the internal clock cannot be set. (When the CLOCK button is pressed, the internal clock will be displayed for 5 seconds.)
- If the signal from a broadcast station is extremely weak or is electrically noisy, you may not be able to set the internal clock.



(Continued)

■ Note for clock-time and date mode

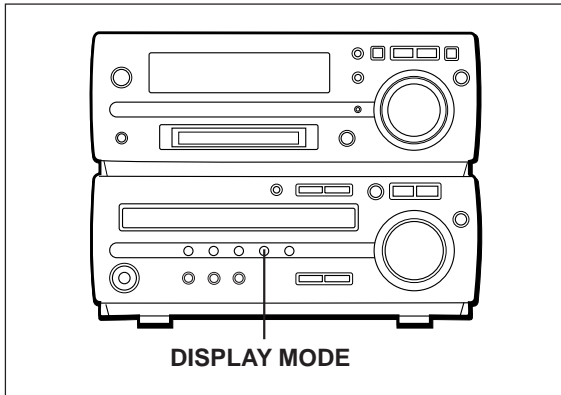

When the **DISPLAY MODE** button is pressed repeatedly to select **CT**, the date (Day-Month-Year) will be displayed for 3 seconds, and then the RDS clock time display will appear.

(Display example; If it is 11:56 on October 31, 2000)

31 10 2000	For 3 seconds
------------	---------------



RDS 11:56	RDS clock time
-----------	----------------

- The RDS clock display appears with the RDS character, so that you will know it is not the internal clock display.

Notes:

- If you tune in to an RDS station which is not broadcasting clock-time and date data (CT data) and you select CT, "NO CT" will be displayed.
- If you are not receiving CT data, even though you are tuned into an RDS station, "CT" will be displayed.
The CT data is sent at the top of each minute.
- If an RDS station signal is extremely weak or the reception is noisy, the clock time may be displayed as "--" (hyphens) or it may not be displayed correctly.
- If you still have not selected the internal clock display mode, the RDS clock display will appear in the 24-hour mode (0:00 - 23:59) (see page 9).
- You must check the clock's accuracy because the RDS time signal (CT data) may not be correct, depending on the individual RDS station.
- The date normally changes at midnight, Greenwich Mean Time (G.M.T.). It may not change at midnight local time.



(Continued)

■ EON-PTY

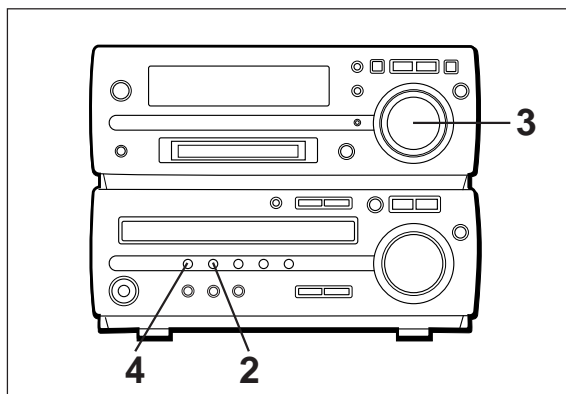

- 1 Tune in the desired RDS station (when a station name is being displayed).

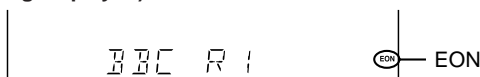

- 2 Press the EON button when "EON" appears.

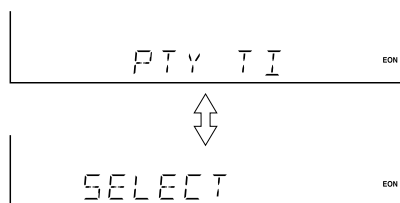

- "PTY TI" and "SELECT" will appear alternately for about 6 seconds.

- 3 Whilst they are being displayed, select the desired programme type by turning the jog dial.

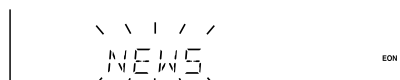

- The selected programme type will flash.

- 4 Within 4 seconds, press the PTY.TI SEARCH button.

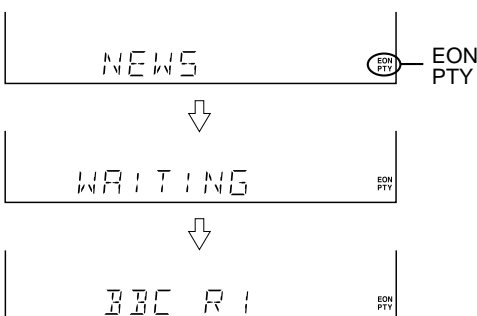

- The selected programme type and "WAITING" will be displayed for 2 seconds each.
- "PTY" will appear, and the unit will enter the EON-PTY stand-by mode.

- 5 When a programme of the type specified starts on an ON (other network) station, the unit will automatically switch to the station broadcasting the selected programme type, and "PTY" will flash.



- 6 When the programme specified for the ON station is over, the unit will automatically return to the original station you were tuned to.

- If the EON button is pressed when "EON" is not displayed, "NO EON" will appear for 5 seconds to indicate that the unit cannot enter the EON stand-by mode.

Checking the stand-by mode setting:

When in the EON stand-by mode, press the EON button.
("Programme type" → "WAITING")

To cancel the EON stand-by mode:

When in the EON stand-by mode, press the EON button.
Within 4 seconds, press it again. The EON stand-by mode will be cancelled.
("PTY" will go out.)

About the PTYI (Dynamic PTY Indicator):

PTYI (Dynamic PTY Indicator) will appear whilst the Dynamic PTY station is being received.

Dynamic PTY indicates that the PTY for the station tuned in, or the PTY referenced in the EON data, is assessed whenever the programme changes and may be changed.

PTYI	Meaning
Lights up	Tuned into a dynamic PTY station.
Goes out	Tuned into a static PTY.

- When "PTYI" appears, if you press the DISPLAY MODE button to display the programme type, you can check the type of programme you are actually receiving.



(Continued)

■ EON-TI

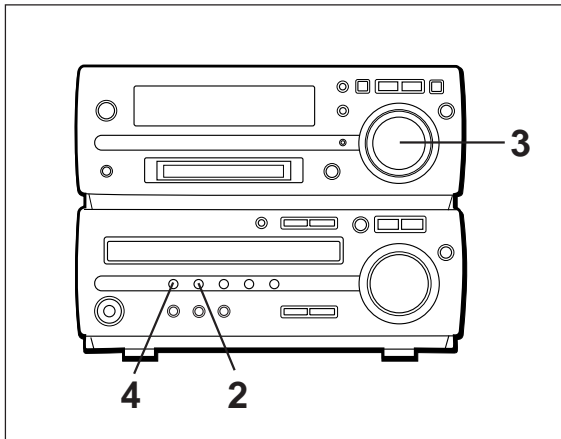

- 1 Tune in the desired RDS station (when a station name is being displayed).



- 2 Press the EON button when "EON" appears.

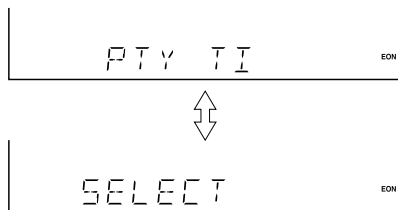

- "PTY TI" and "SELECT" will appear alternately for about 6 seconds.

- 3 Whilst they are being displayed, select the TI (Traffic Information) by turning the jog dial.

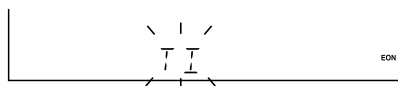

- 4 Within 4 seconds, press the PTY.TI SEARCH button.

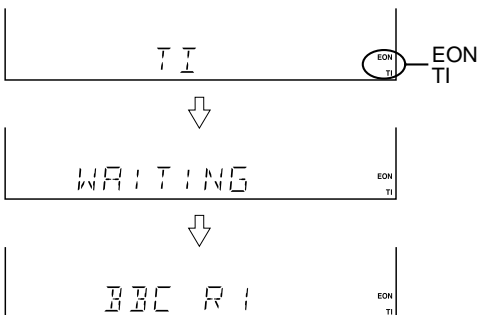

- "TI" and "WAITING" will appear for 2 seconds each.
- "TI" will appear, and the unit will enter the EON-TI stand-by mode.

- 5 When a TA specified starts on an ON (other network) station, the unit will automatically switch to that station, and "TI" will flash.



- 6 When the traffic announcement is over, the unit will automatically return to the original station you were tuned to.

- If the EON button is pressed when "EON" is not displayed, "NO EON" will appear for 5 seconds to indicate that the unit cannot enter the EON stand-by mode.

Checking the stand-by mode setting:

When in the EON stand-by mode, press the EON button. ("TI" → "WAITING")

To cancel the EON stand-by mode:

When in the EON stand-by mode, press the EON button. Within 4 seconds, press it again. The EON stand-by mode will be cancelled.

- "TI" will go out.

Note:

- If neither "TP" nor "TA" appears, then even if "EON" appears, the unit cannot enter the EON-TI stand-by mode. In this condition, if the PTY. TI SEARCH (PTY. TI) button is pressed after TI is selected, "NO TI" will flash for 4 seconds.



(Continued)

■ About the TP and TA indicators

TP indicator	TA indicator	Meaning
Not lit	Not lit	This programme does not carry traffic announcements nor does it refer, via EON, to a programme that does.
Not lit	Lit	This programme carries EON information about another programme which gives traffic information.
Lit	Not lit	This programme carries traffic announcements but none are being broadcast at present and may also carry EON information about other traffic announcements.
Lit	Lit	A traffic announcement is being broadcast on this programme at present.

In the following cases, the EON stand-by mode will be cancelled.

- When you press the ON/STAND-BY button to enter the stand-by mode.
- When the unit is switched to another band in the EON stand-by mode.
- When you change the FM station whilst in the EON stand-by mode.
- When a preset call is made.

Notes:

- During the same programme as the specified PTY (or TA) is being broadcast on the station you are receiving, the unit will not switch to an ON (other network) station.
- If there are more than two other network stations you want to listen to, compare the strength of each station's signal and tune in the station with the strongest signal (EON-AF).
However, if the frequency of other network station has been stored in the preset channel memory, the unit will switch to that preset channel.
- If you want to cancel the reception of an ON (other network) station which was tuned in by the EON system and return to the original station you were receiving, press the EON button.
- After the unit returns to the original station, the stand-by mode will still be active. (The "TI" or "PTY" will remain lit.)
- The unit does not switch from the ON station to another network station. It returns to the original station.
- When the unit switches automatically to "other network" station, if there is any problem with this station or the station cannot be received properly, "WEAK SIG" will appear and the unit will return to the original station.
- Even if the unit switches from the station you are listening to directly to one "other network" station which is in the preset memory, if the signal is very weak, the unit will search for another station of other network and find out the station with the strongest signal and switch to it.
However, if the signals from all the other network stations are very weak, or if the tuning conditions are very bad (due to electrical noise), the unit displays "WEAK SIG", and it will return to the original station you were receiving.



RECORDING

■ Differences from tape recordings

You cannot record music on the reverse side of a MiniDisc.

MiniDiscs are single sided and should only be inserted with the correct side up.

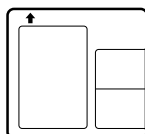

You don't need to search for the starting point at which to record.

The unit automatically finds the point at which recording can start. Recording will start from that point.

You can check the total or remaining recordable time (possible recording) before recording.

This lets you plan a recording session so that the last song will not come to an abrupt end before it has finished.

■ Disc writing (TOC)

The TOC (Table of Contents) is information on track numbers and recording areas to allow the unit to recognize musical selections or sounds.

The entire MiniDisc is controlled depending on this TOC, which enables the unit to find the beginning of a track quickly or to automatically record in a vacant area.

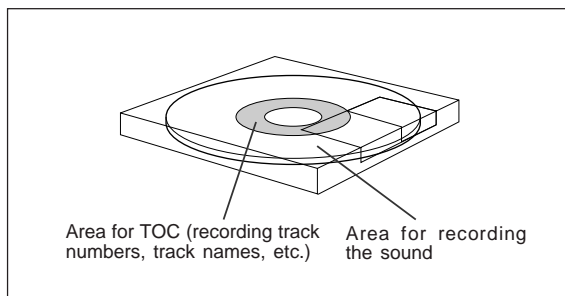

When you start recording or editing, "TOC" will appear in the display window.

This indicates that information in the TOC is now being changed according to the recording or editing being performed. (The changed TOC is not yet recorded on the MiniDisc at this time.)

The TOC is recorded when

- you stop recording.
- you switch to another input source.
- you eject the MiniDisc.
- you enter the stand-by mode.

Do NOT unplug the power lead whilst the TOC is being recorded ("TOC" is flashing) and do NOT impart shock to the unit. Otherwise, TOC will not be correctly recorded, and consequently proper playback may not be possible.

■ About track numbers

When recording from a CD

New track numbers will be created automatically according to the original tracks (Synchro mark function).

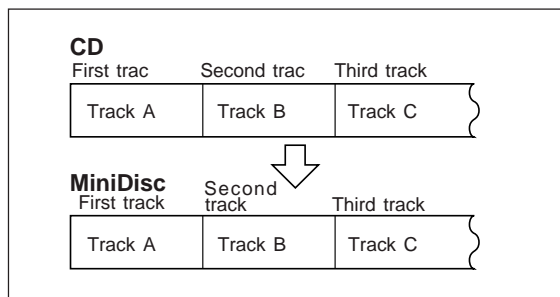

- When you record from a CD to a MiniDisc, the track numbers recorded on the MiniDisc may not match the track numbers on the CD.

If this happens, correct the track numbers using the DIVIDE (page 39) and COMBINE (page 39) functions after recording.

Recordings cannot be made in the following situations.

- If you try recording on a playback-only MiniDisc (commercially available music MiniDisc).
- If a MiniDisc is protected against accidental erasure (page 46).
- If there is no more recording time left on the disc (page 47).
- When the "TOC FULL" message appears (page 49).
- If a disc's TOC has been damaged.

Notes:

- When recording important selections, be sure to make a preliminary test to ensure that the desired material is being properly recorded.
- The VOLUME, X-BASS, EQUALIZER and SURROUND controls can be adjusted with no effect to the recorded signal (Variable Sound Monitor).



(Continued)

■ Recording from a CD onto a MiniDisc (One-Touch Editing)

A CD can be recorded to a MiniDisc, starting from the first track, with one-touch operation.

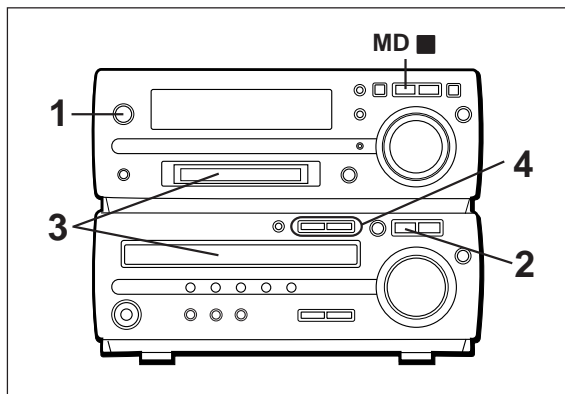

- 1 Press the ON/STAND-BY button to turn the power on.
- 2 Press the CD ■ button.
- 3 Load a CD and a recordable MiniDisc.
 - The total number of tracks and the total playing time on the CD will be displayed.
- 4 Press the CD ► MD EDIT (HIGH or NORMAL) button.
 - Press the NORMAL button for actual speed, HIGH for high-speed recording.



- Recording will begin, starting from the first track of CD.
- After recording (all of the tracks that can be recorded), the unit will stop automatically.

To check the remaining time available for recording:

- ① Press the MD ■ button.
 - ② Load a MiniDisc.
 - ③ Press the DISPLAY button to find the time followed by hyphen.
- The total number of tracks previously recorded and the available remaining time will be displayed, the unit will return to the original display 4 seconds later.

To cancel the operation:

Before pressing the CD ► MD EDIT (HIGH or NORMAL) button, press the CD ■ button.

To stop recording:

Press the MD ■ button.

- Playback and recording will stop and the track numbers will be written on the MiniDisc.

Caution:

- When a recording is made at high speed, the playback sound will not be heard.
- Check whether recording is performed or not with the level meters.
- You cannot adjust the sound volume. "VOL HOLD" appears when you adjust the sound volume whilst recording at high speed.
- When a damaged CD is recorded at high speed, the unit may stop whilst recording, or some noise or a drop out may be recorded. In this case, record the CD at normal speed.

Notes:

- When the CD playing time is longer than the available MiniDisc recording time, the recording process will not start even when the CD ► MD EDIT button is pressed.

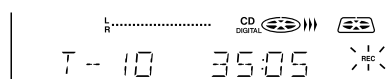

Total number of recordable tracks (from the first track)

Available recording time

- To record as many tracks as are available, press the CD ► MD EDIT button again. Then, when the CD ► MD EDIT button is pressed again, recording will start. However, when the MiniDisc runs out of space, "DISC FULL" will be displayed and the CD and MiniDisc will stop. However, if the available recording time on the MiniDisc is less than the length of the first track on the CD, recording will not be performed.

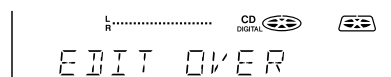



(Continued)

■ Track editing from a CD onto a MiniDisc

You can record several consecutive tracks, starting from the first track of a CD, to a MiniDisc.

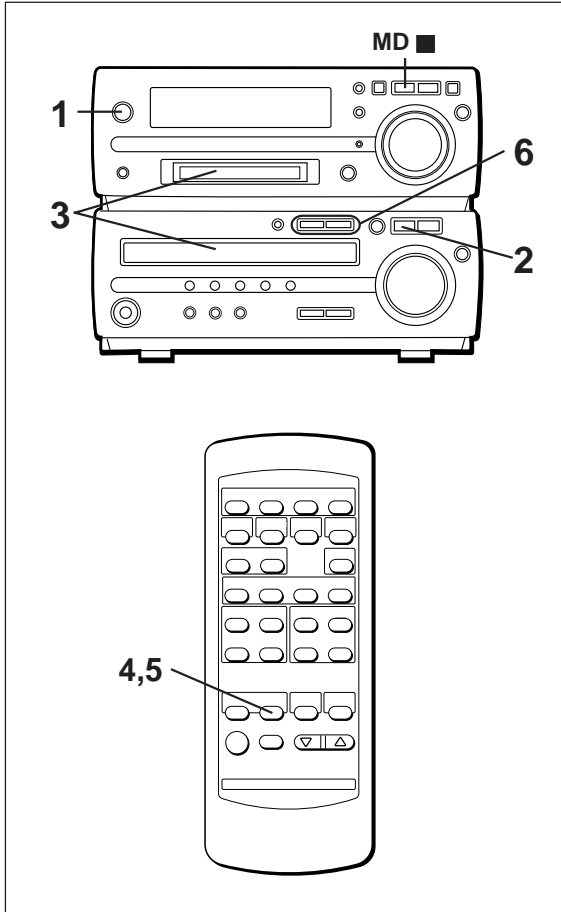

1 Press the ON/STAND-BY button to turn the power on.

2 Press the CD ■ button.

3 Load a CD and a recordable MiniDisc.

4 Press the TRACK EDIT button.

When selecting CD

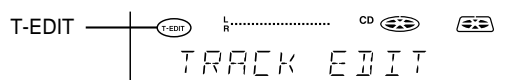

5 Press the TRACK EDIT button repeatedly to select the last track number you want to record.

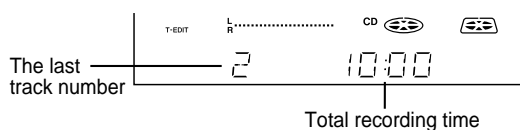

- If you select 21 tracks or more, "E. OVER" will be displayed.

6 Press the CD ► MD EDIT (HIGH or NORMAL) button.



- The CD loaded will be recorded in order, starting from the first track. When a MiniDisc runs out of recording space or when a CD has been completely recorded, the CD and the MiniDisc will stop automatically.
- Recording will begin, starting from the first track of CD.
- Selected tracks will be recorded in order. After the unit has finished recording the last track, recording will stop automatically.

Note:

- When repeat play has been set, if you press the CD ► MD EDIT (HIGH or NORMAL) button, the repeat mode will be cancelled automatically, and track editing will start.

To stop recording:

Press the MD ■ button.

- Playback and recording will stop and the track numbers will be written on the MiniDisc.



(Continued)

■ APMS recording from a CD onto a MiniDisc

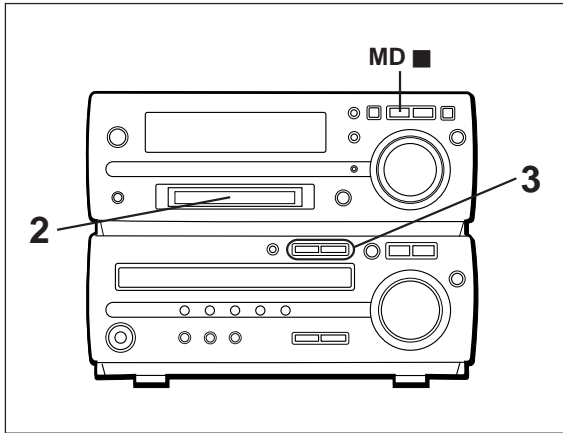

1 Select tracks for APMS playback (page 14).

2 Load a recordable MiniDisc.

3 Press the CD ► MD EDIT (HIGH or NORMAL) button.

- APMS playback will start, and recording will start automatically.
- Programmed tracks will be recorded in order. After the unit has finished recording the last track, recording will stop automatically.

Note:

- When repeat play has been set, if you press the CD ► MD EDIT (HIGH or NORMAL) button, the repeat mode will be cancelled automatically, and APMS recording will start.

To stop recording:

Press the MD ■ button.

- Playback and recording will stop and the track numbers will be written on the MiniDisc.

■ To record without using One-Touch Editing

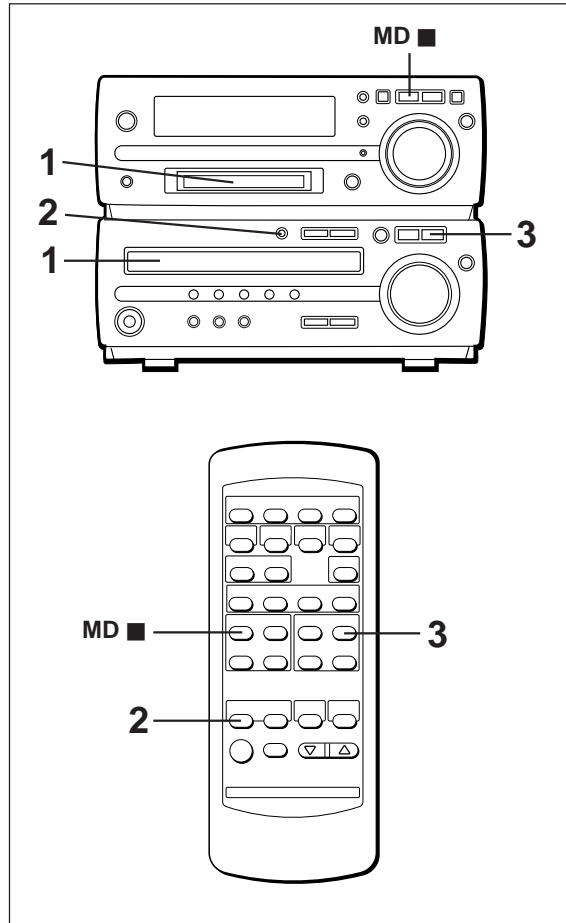

1 Load a CD and a recordable MiniDisc.

2 Press the ● REC button.

- The unit will enter the recording stand-by mode.

3 Press the CD ► button.

To stop recording:

Press the MD ■ button.

- Recording will stop and the track numbers will be written on the MiniDisc.



(Continued)

■ Recording from the built-in radio onto a MiniDisc

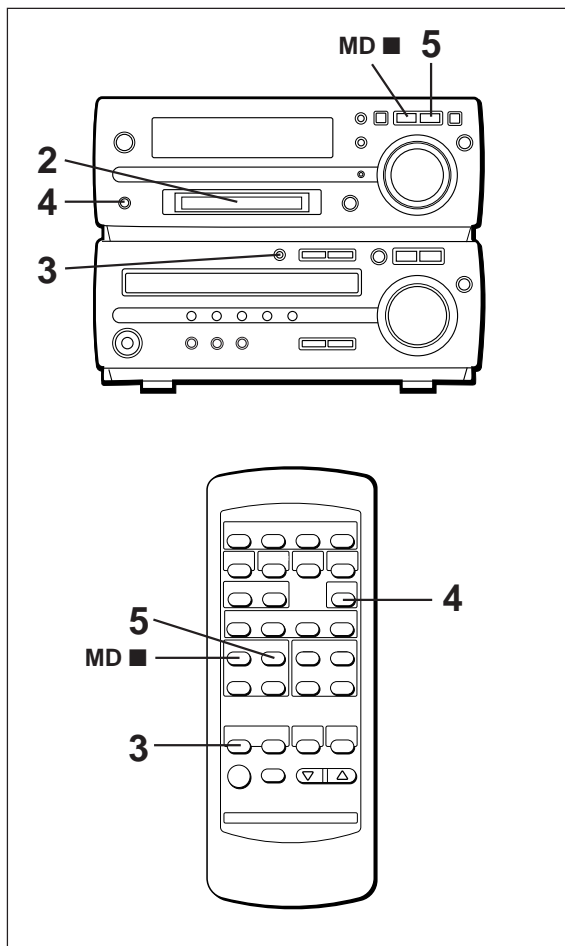

To stop recording:

Press the MD ■ button.

The recording will stop and the track number will be written on the MiniDisc.

To record the track number whilst recording:

The recording is performed as a single track.

To identify different sections of a recording, you can increase the track number at any point during the recording process.

To create a new track number whilst in the recording mode, press the ● REC button.

● The track number will increase by one, and then the recording will continue.

1 Tune in to the desired station (pages 17 - 18).

2 Load a recordable MiniDisc.

3 Press the ● REC button.

● The unit will enter the recording stand-by mode.

4 Check the recordable time by pressing the DISPLAY button.

Notes:

● Before recording an AM broadcast, enter the recording stand-by mode, and then separate the AM loop aerial from the main unit. Adjust it so that the AM broadcast can be tuned in most clearly.

● During recording, you cannot change the station.

5 Press the MD ►|| button.



EDITING

What the editing function can do

You can create original discs using the MiniDisc editing function, on which you can change the order of the tracks and you can create disc or track names.

- Playback-only MiniDiscs cannot be edited.
- Tracks (up to 255 tracks per disc) can be named. Since track names are displayed when the beginning of each track is located or during playback, you can quickly check the name of each track.

To create a disc name

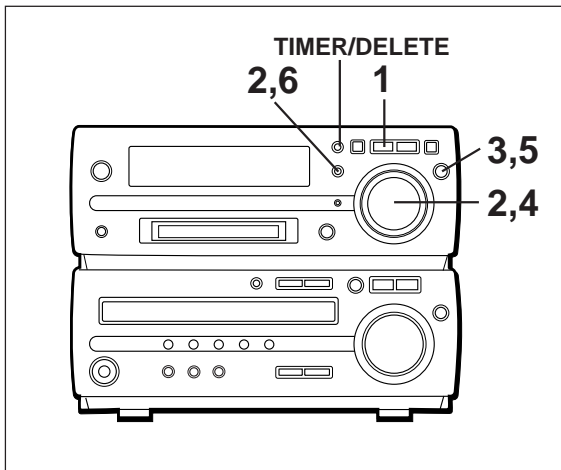

1 Press the MD button.

- The total number of tracks and the total playing time on a MiniDisc will appear.

2 Press the NAME/TOC EDIT button, and then select "DISC NAME" using the jog dial.

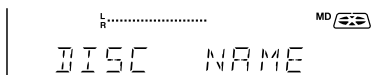

3 Within 10 seconds, press the MEMORY/ENTER button.

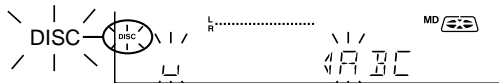

- The unit will enter the character input mode.

4 Select the character you want using the jog dial.

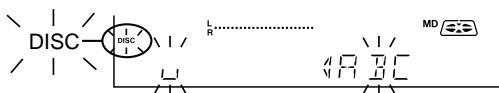

5 Press the MEMORY/ENTER button to enter the character.

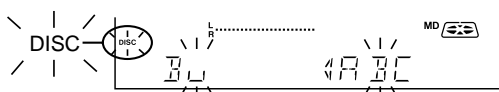

- Repeat steps 4 to 5 above to enter the characters in the name.

6 After entering all of the characters in the name, press the NAME/TOC EDIT button.

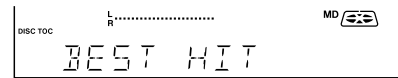

- The disc name will be recorded.

To erase a disc name:

After performing steps 1 to 3.

- 1 Press the TIMER/DELETE button for 2 seconds or more.
 - "NAME CLEAR" will flash.
- 2 Press the MEMORY/ENTER button.

Notes:

- Up to 40 characters can be entered.
- This function cannot be used in the random play mode and APMS play mode.

Type of characters used

Type of characters	Characters (Symbols)
Capital letters	A B C D E F G H I J K L M N O P Q R S T U V W X Y Z
Symbols	1 2 3 4 5 6 7 8 9 0 ! " # \$ % & ' () * + , - . / ? @ < = > _ `

Number of characters you can enter

● Disc names and track names

Up to 40 characters (including spaces) can be entered for each name.

If more than 40 characters are entered, "NAME FULL" will appear.

● Total number of characters per MiniDisc

A total of approximately 1,700 characters can be used for all of the disc and track names. If more than 1,700 characters are entered, "TOC FULL" will appear.

Whilst editing, the "TOC" indicator is displayed. This means the edit results have not been recorded on the MiniDisc.

To record the results, select another input or set the unit to the stand-by mode. During writing, the "TOC" goes out, all editing changes will be recorded on the disc.

Note:

- Storing the edited contents on the disc can be done after several pieces of editing have been finished.



(Continued)

■ To create a track name

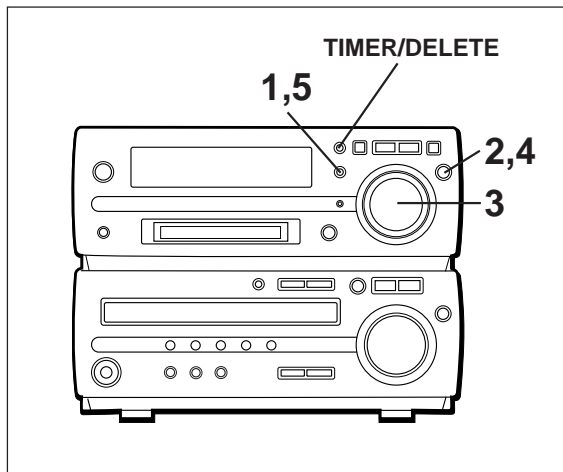

1 During playback or in the pause mode, press the NAME/TOC EDIT button.

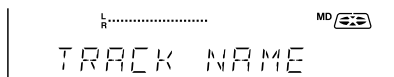

2 Within 10 seconds, press the MEMORY/ENTER button.

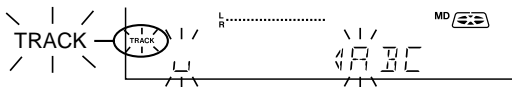

- The unit will enter the character input mode.
- The track you are listening to will be played repeatedly.

3 Select the character you want using the jog dial.

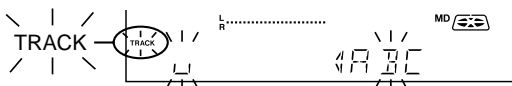

4 Press the MEMORY/ENTER button to enter the character.

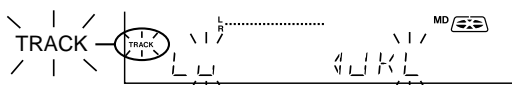

- Repeat steps 3 to 4 above to enter the characters in the name.

5 After entering all of the characters in the name, press the NAME/TOC EDIT button.

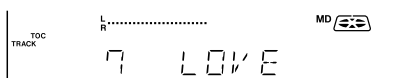

- The track name will be recorded.
- The unit will return to normal playback.

To erase a track name:

After performing steps 1 to 2.

- ① Press the TIMER/DELETE button for 2 seconds or more.
 - "NAME CLEAR" will flash.
- ② Press the MEMORY/ENTER button.

Notes:

- Up to 40 characters can be entered.
- This function cannot be used in the random play mode and APMS play mode.
- If you create a track name whilst recording the track, make sure you finish entering the name before you finish recording the track. If the end of the recording is reached before you have entered the complete name, only the characters entered before the recording ended will be recorded.



(Continued)

■ To change disc names and track names

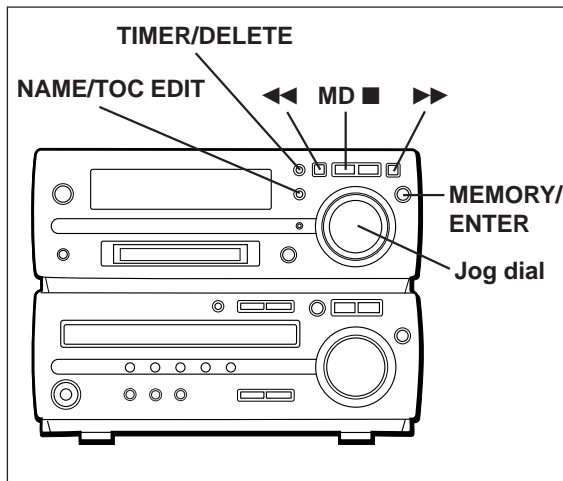

● To delete a character:

(Example: To change "BESUT" to "BEST")

1 To change disc names, perform steps 1 - 3 on page 36. To change track names, perform steps 1 - 2 on page 37.

2 Press the ◀ or ▶ button to flash the character to erase.

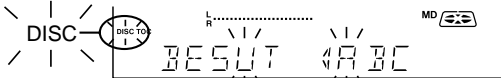

● To cancel the operation, press the MD ■ button.

3 Press the TIMER/DELETE button.

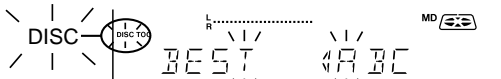

● After this step, if you are not going to enter a character, go to step 5.

4 Select the character you want to add, using the jog dial. Then, press the MEMORY/ENTER button.

● The selected character will be added, and the original characters will move to the right by one.

5 After entering all of the characters in the name, press the NAME/TOC EDIT button.

● To add a character:

(Example: To change "BET" to "BEST")

1 To change disc names, perform steps 1 - 3 on page 36. To change track names, perform steps 1 - 2 on page 37.

2 Press the ◀ or ▶ button to flash the character at the place you want to add a letter.

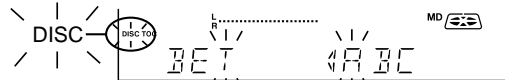

● To cancel the operation, press the MD ■ button.

3 Select the character you want to add, using the jog dial. Then, press the MEMORY/ENTER button.

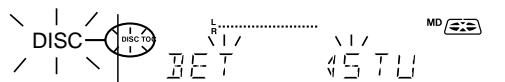

● The selected character will be added, and the original characters will move to the right by one.

4 After entering all of the characters in the name, press the NAME/TOC EDIT button.

Note:

● You cannot modify disc or track names created on other equipment if they are over 40 characters. In this case, erase the name and then enter a new name.



(Continued)

■ Divide

A single track can be divided into two at any desired position.

- The numbers of the tracks which come after the newly divided track will be automatically increased by one.

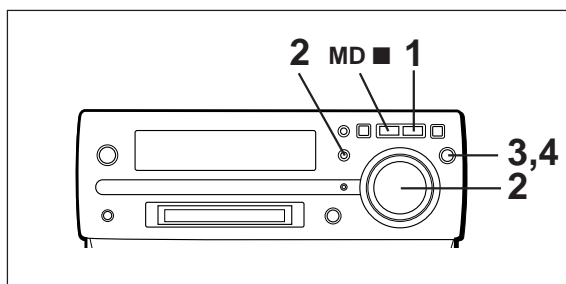
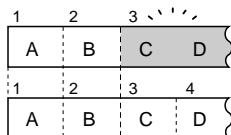

- 1 Play the track which you want to divide into two, and press the MD button at the point where you want to divide the track.

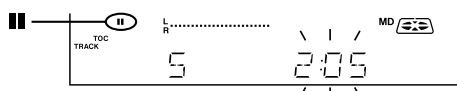

- 2 Press the NAME/TOC EDIT button, and within 10 seconds, select "DIVIDE" using the jog dial.



- 3 Within 10 seconds, press the MEMORY/ENTER button.

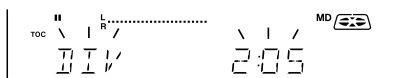

- To cancel the operation, press the MD button.

- 4 Press the MEMORY/ENTER button again.



- The track is divided, and the unit is stopped at the beginning of the second of the two tracks.
- The numbers of the tracks which come after the divided track are automatically increased by one.
- When a track which has been given a name is divided, the two new tracks will have the same name. If the "TOC FULL" message is seen, the second track may not be given a name (page 47).

Notes:

- This unit can hold up to 255 tracks. However, even if the number of tracks assigned has not reached 255, it might not be possible to make any further divisions of tracks (page 47).
- This function cannot be used in the random play mode and APMS play mode.

■ Combine

Two consecutive tracks can be combined into one track.

- The numbers assigned to the tracks following the combined tracks will be decreased by one automatically.

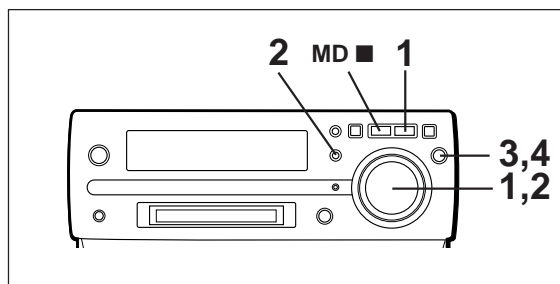
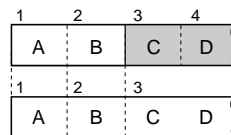

- 1 Whilst in the stop mode, select the second of the two adjacent tracks you want to combine using the jog dial.

Or start playing the second of the two tracks you want to combine, and then press the MD button.

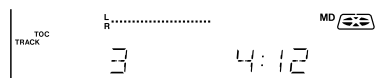

- 2 Press the NAME/TOC EDIT button, and within 10 seconds, select "COMBINE" using the jog dial.



- 3 Within 10 seconds, press the MEMORY/ENTER button.

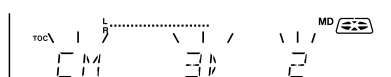

- To cancel the operation, press the MD button.

- 4 Press the MEMORY/ENTER button again.



- The two tracks are combined, and the unit is stopped at the beginning of the combined track.
- The numbers assigned to the tracks following the combined track are automatically decreased by one.

When both tracks have a name:

- When only the first track has a name → That name will be used.
- When only the second of the two tracks has a name → That name will be used.
- When both tracks have a name → The name of the first track will be used.



(Continued)

To combine two non-contiguous tracks:

(Example: the first and third tracks)

Move the third track to the second track using the MOVE function.

Then, combine the first and second tracks using the COMBINE function.

Notes:

- Tracks recorded from analogue inputs cannot be combined with tracks recorded from CDs or MiniDiscs using the digital inputs.
- Tracks recorded in the stereo mode cannot be combined with tracks recorded in the monaural long-play mode.
- Tracks where either track's recording time is less than 15 seconds may not be combined.
- This function cannot be used in the random play mode and APMS play mode.

Move

A designated track can be moved to any desired position.

- The numbers assigned to the tracks following the track which is moved will be adjusted automatically.

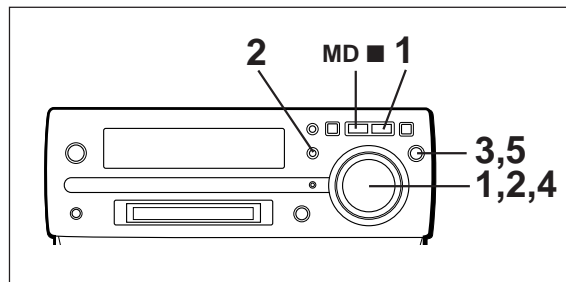
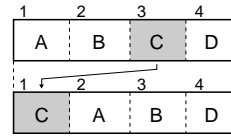

- 1 Whilst in the stop mode, select the track you want to move using the jog dial.
Or start playing the track to be moved, and then press the MD button.

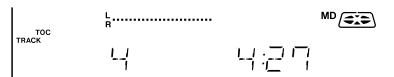

- 2 Press the NAME/TOC EDIT button, and within 10 seconds, select "MOVE" using the jog dial.

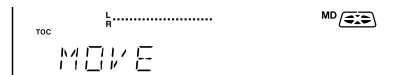

- 3 Within 10 seconds, press the MEMORY/ENTER button.

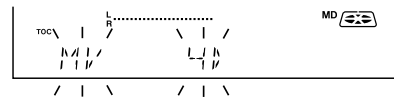

- 4 Select the new track position using the jog dial.

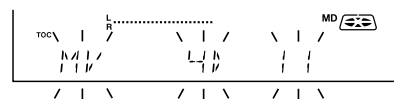

- To cancel the operation, press the MD button.

- 5 Press the MEMORY/ENTER button again.



- The track is moved, and the unit is stopped at the beginning of the new track selected in step 4.

Notes:

- When a track has been moved, the other tracks which are affected will be assigned new track numbers automatically.
- This function cannot be used in the random play mode and APMS play mode.



(Continued)

■ Erase

Tracks you want to erase can be erased one at a time.

- Once a track has been erased, it cannot be recovered. Double-check the track number before erasing it.

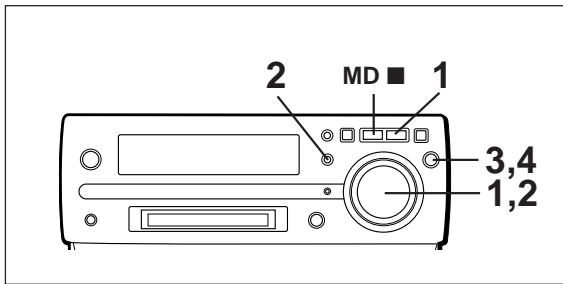
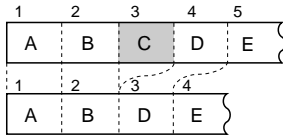

To erase tracks one at a time:

- 1 Whilst in the stop mode, select the track you want to erase using the jog dial.
Or start playing the track to be erased, and then press the MD button.

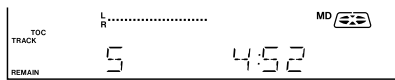

- 2 Press the NAME/TOC EDIT button, and within 10 seconds, select "ERASE" using the jog dial.

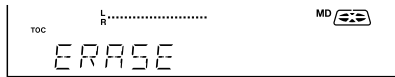

- 3 Within 10 seconds, press the MEMORY/ENTER button.

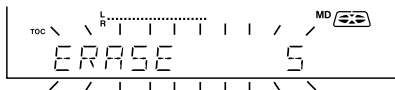

- To cancel the operation, press the MD button.

- 4 Press the MEMORY/ENTER button again.

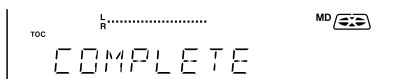

- The track is erased, and the unit is stopped at the beginning of the next track.

Notes:

- When a track is erased, the numbers assigned to the tracks following the erased track will be automatically decreased by one.
- When a track is erased, the track name will be erased at the same time.
- This function cannot be used in the random play mode and APMS play mode.

■ All Erase

All of the tracks you want to erase can be erased at once.

- Once all of tracks have been erased, they cannot be recovered. Double-check the tracks before erasing them.

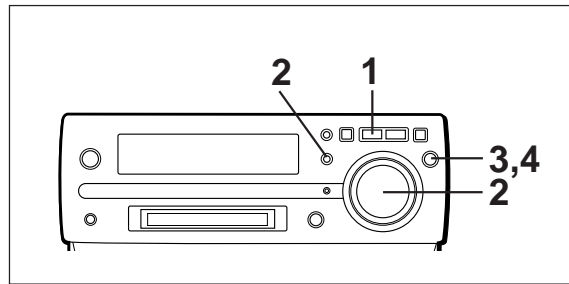
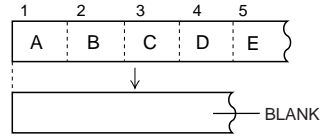

To erase all of the tracks at once:

- 1 Press the MD button.

- The total number of tracks and the total playing time on a MiniDisc will appear.

- 2 Press the NAME/TOC EDIT button, and within 10 seconds, select "ALL ERASE" using the jog dial.

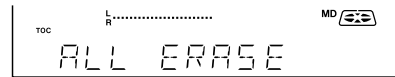

- 3 Within 10 seconds, press the MEMORY/ENTER button.

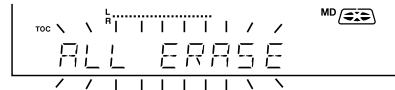

- To cancel the operation, press the MD button.

- 4 Press the MEMORY/ENTER button again.

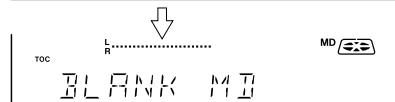

- All of the track numbers and track names will be erased.

Note:

- This function cannot be used in the random play mode and APMS play mode.



TIMER OPERATION

- Before setting the timer, make sure that the clock setting is correct (page 9).

■ Timer playback/Timer recording

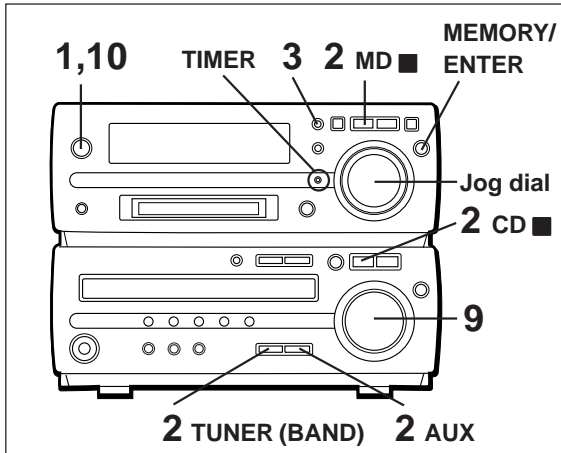

Before timer operation, the following preparations are required.

- Load a CD, a recordable MiniDisc for timer recording.
- Preset the radio station.

1 Press the ON/STAND-BY button to turn the power on.

2 (To select timer playback)

Press the CD ■, MD ■, TUNER (BAND) or AUX button.

(To select timer recording)

Press the CD ■, TUNER (BAND) or AUX button.

3 (To select timer playback)

Press the TIMER/DELETE button to select the timer playback mode.



(To select timer recording)

Press the TIMER/DELETE button again to select the timer recording mode.



4 Whilst "Ⓞ PLAY" or "Ⓞ REC" is flashing, press the MEMORY/ENTER button.

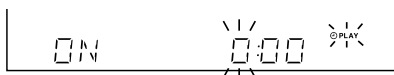

5 Turn the jog dial to set the hour to start, and then press the MEMORY/ENTER button.

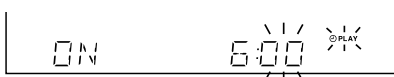
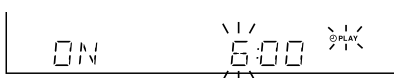

6 Turn the jog dial to set the minute to start, and then press the MEMORY/ENTER button.

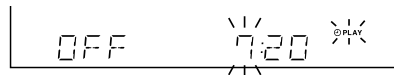

- If the ending time is not set manually, it will automatically be set for one hour after the starting time.

7 Turn the jog dial to set the hour to stop, then press the MEMORY/ENTER button.

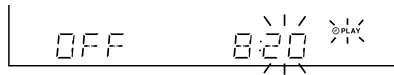
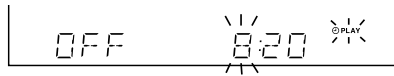

8 Turn the jog dial to set the minute to stop, then press the MEMORY/ENTER button.

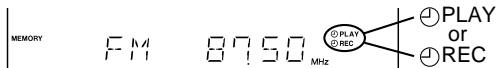

9 Adjust the VOLUME control for the desired volume.

- Be careful not to turn the volume up too high.

10 Press the ON/STAND-BY button to enter the stand-by mode.

- The TIMER indicator will light up.

11 When the timer start time is reached, timer playback or timer recording will start.

12 When the timer end time is reached, timer recording will stop.

Notes:

- The timer cannot control the component connected to the Auxiliary input sockets.
- When the CD or MiniDisc is played to the end, playback will stop before the stop time.
If you wish to play to the stop time, set repeat play for the CD or MiniDisc.
- Timer playback and timer recording cannot be set at the same time using the timer.



(Continued)

To confirm the timer setting:

Press the TIMER/DELETE button once.

- The turn-on time, the turn-off time will be displayed.

To cancel timer operation:

- ① Whilst in the timer stand-by mode, press the ON/STAND-BY button to turn the power on.
- ② Press the TIMER/DELETE button repeatedly to turn off the timer, "⊕ PLAY" or "⊕ REC" will go out.

Caution:

In the following cases, the timer recording function will not work.

- When a MiniDisc has not been inserted.
- When a playback-only MiniDisc is inserted.
- When the MiniDisc you inserted is protected against accidental erasure.
- When there is no recording space left on the MiniDisc you have inserted (when the "TOC FULL" or "DISC FULL" message appears).

■ Sleep operation

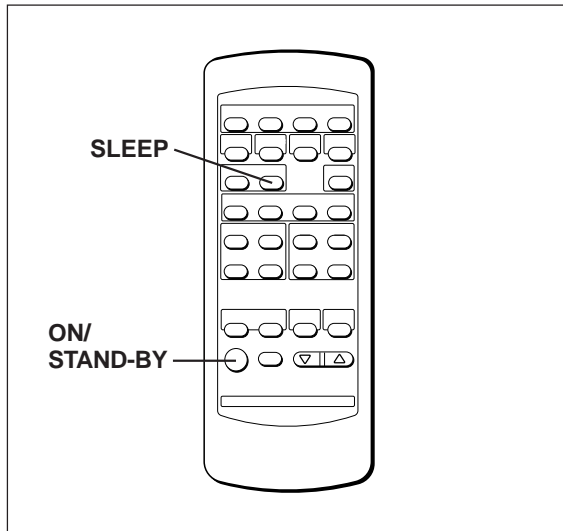

The radio, CD and MiniDisc can all be turned off automatically.

1 Play the desired sound source.

2 Press the SLEEP button.



- If you do not need to change the time, the unit will enter the sleep mode automatically.

3 Press the SLEEP button to select the time.

(Maximum: 2 hours - Minimum: 30 minutes)

The amount of sleep time can also be changed during the sleep operation.

- 2 hours-30 minutes → 30-minute intervals

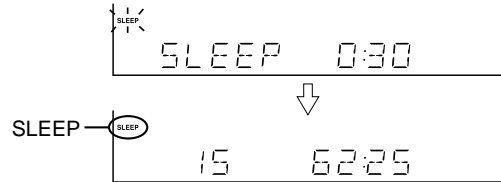

4 The unit will enter the stand-by mode automatically after the preset sleep time has elapsed.

To cancel the sleep operation:

Press the SLEEP button repeatedly. "0:00" will appear and "SLEEP" will go out at the same time.

- The sleep operation will be cancelled.

To confirm the remaining sleep time:

Press the SLEEP button.

Notes:

- Once the sleep time is set, it will remain the same duration until the setting is changed.
- The sleep functions of this unit cannot be used to control equipment connected to this unit. You must use the sleep functions of the other equipment, if it has them.

■ Simultaneous sleep and timer operation

- ① Perform steps 1 - 9 on page 42, "Timer playback/Timer recording".
- ② Perform steps 1 - 3 of the "Sleep operation" on this page.

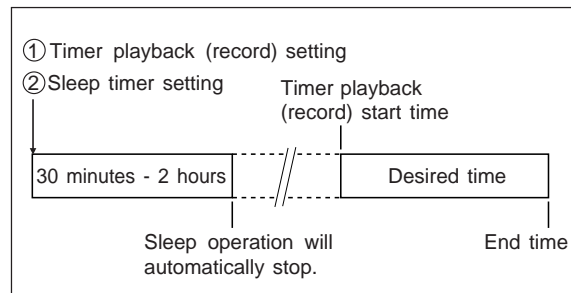



USING EXTERNAL UNITS

■ Connecting external units

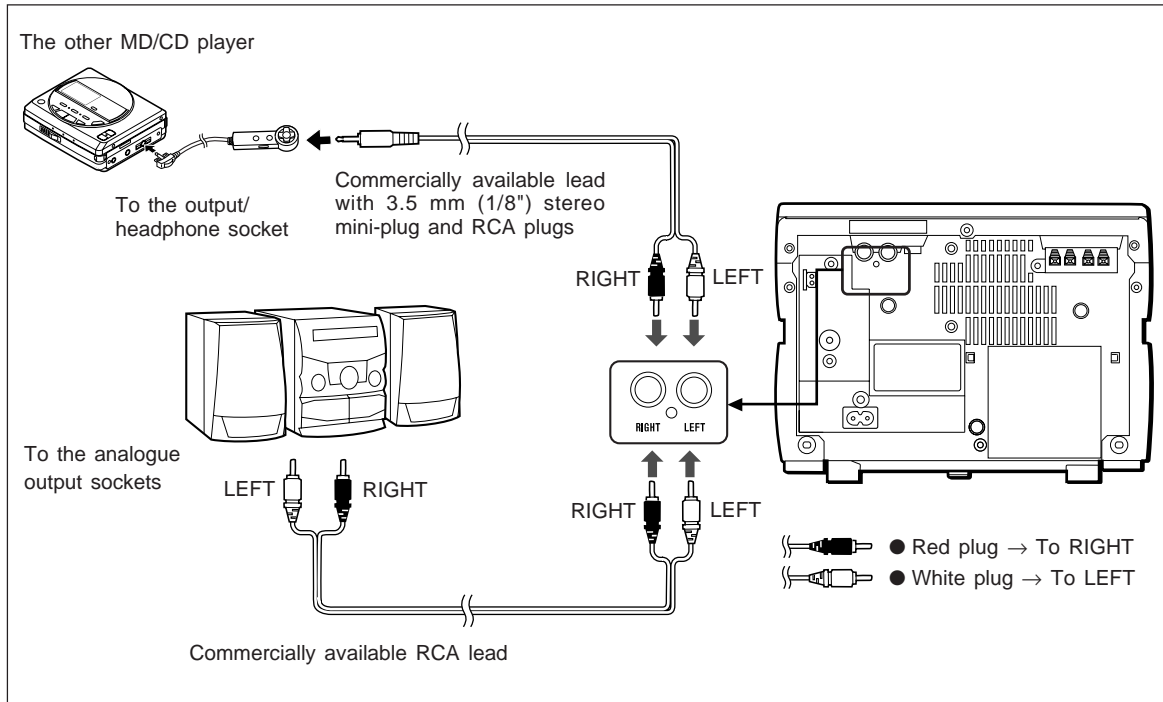

Before connecting external units, set this unit to the stand-by mode and turn off the power to the external units.

■ Headphones

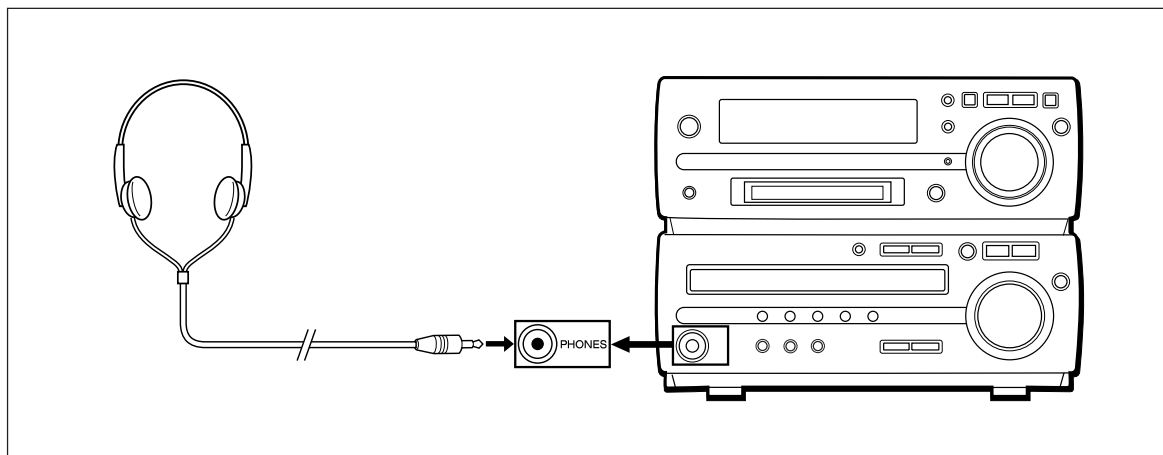

Notes:

- Before plugging in or unplugging the headphones, make sure the volume level is reduced.
- Be sure your headphones have a 3.5mm (1/8") diameter plug and are between 16 ohms and 50 ohms impedance. The recommended impedance is 32 ohms.
- When headphones are connected, the speakers are disabled automatically. Adjust the VOLUME control for the desired volume.





(Continued)

■ Listening to sound from an external unit

To listen to sound from an external unit connected to the analogue input terminals:

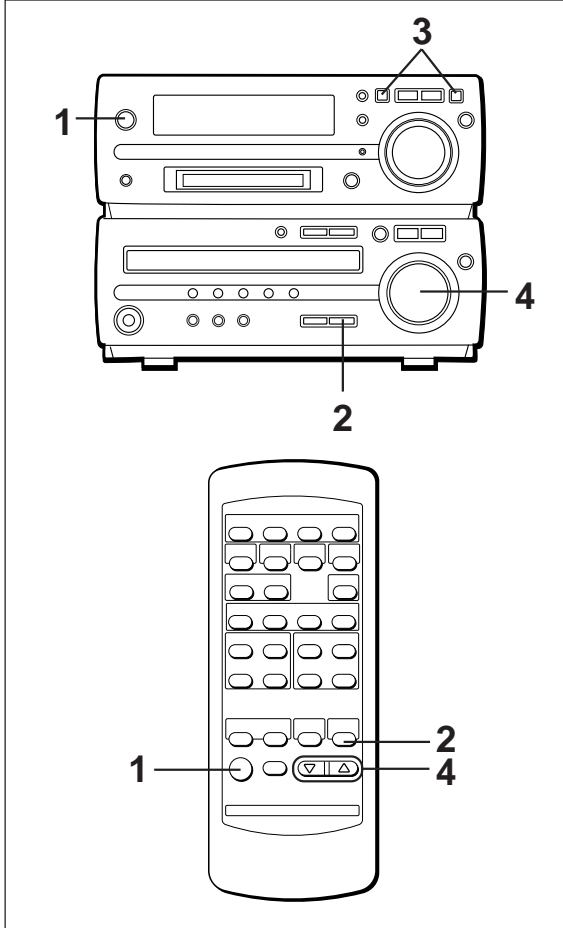

- 1 Press the ON/STAND-BY button to turn the power on.
- 2 Press the AUX button.
- 3 Start playback on the external unit, and adjust the input sound level using the ◀◀ or ▶▶ button.
 - Adjust the recording level so that the "OVER" indicator does not light at the maximum level.

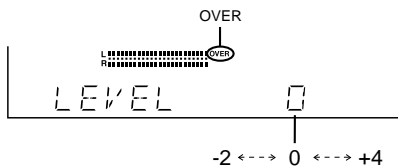

- 4 Adjust the sound level using the VOLUME buttons on the remote control or the VOLUME control on this main unit.

■ Manual recording

You can start a recording manually whilst listening to playback from other external equipment (tape deck, tuner) connected to the auxiliary input.

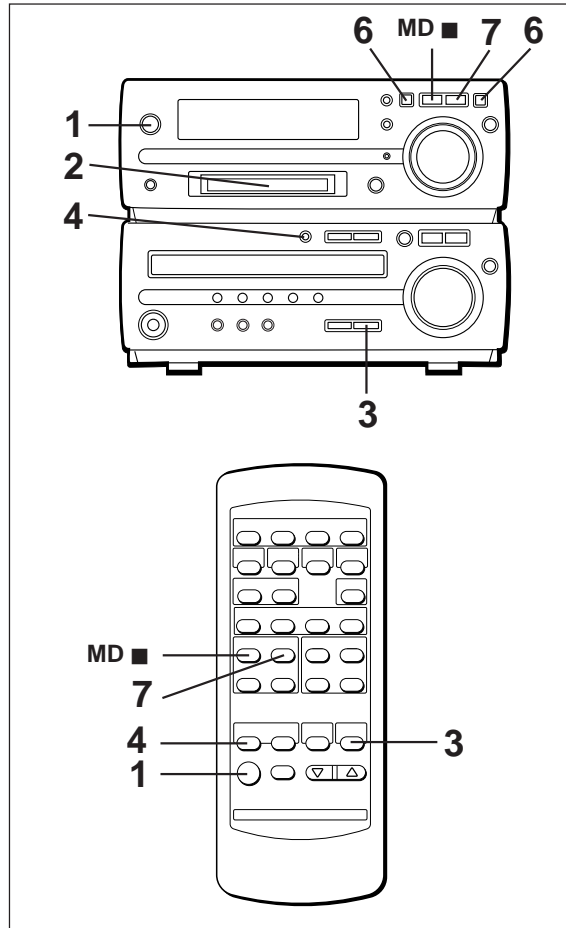

- 1 Press the ON/STAND-BY button to turn the power on.
- 2 Load a recordable MiniDisc.
- 3 Press the AUX button.
- 4 Press the ● REC button.
- 5 Start playback on the external unit.
- 6 Adjust the recording level using the ◀◀ or ▶▶ button.
 - Adjust the recording level so that the "OVER" indicator does not light at the maximum level.

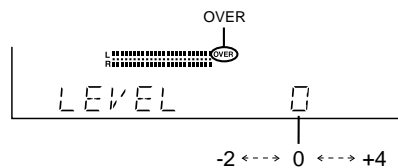

- 7 Press the MD ▶|| button.

To stop recording:
Press the MD ■ button.





WHAT IS A MINIDISC?

The disc is stored in a cartridge. You can handle it easily without worrying about dust, fingerprints, etc. However, dust entering the opening of the cartridge, dirt on the cartridge, warping, etc. may cause malfunctions. Please note the following.

■ Handling the MiniDisc

Do not touch the disc directly!

Do not open the shutter or touch the disc directly. If the shutter is opened forcibly, it may break.

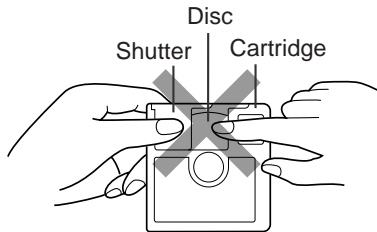

Where not to store discs:

Do not store discs in places with high temperatures or humidity. Specifically, do not leave discs in places exposed to direct sunlight or in cars with doors and windows closed. Do not leave discs in places where sand can get into the cartridge easily (e.g. beaches).

■ To prevent recorded discs from being erased accidentally

Slide the accidental erase prevention tab, located on the side of the disc, in the direction indicated by the arrow.

- The disc will then be protected against accidental erasure.
- To add a recording to such a disc, slide the accidental erase prevention tab back to its original position.

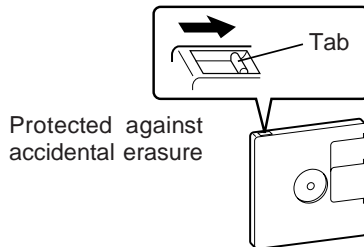

■ What is a MiniDisc?

- A MiniDisc is a 64 mm (2-1/2") diameter disc which is stored in a cartridge. MiniDiscs are easy to handle, compared to CDs, because they are protected against dust and scratches.
- Recording and playback use a digital system with a sound quality that is similar to that found on CDs. MiniDiscs cannot twist or stretch like tapes. The quality of sound will not deteriorate. MiniDiscs are extremely durable.
- Never disassemble MiniDiscs.

■ Adaptive TRansform Acoustic Coding

[ATRAC]

The ATRAC (Adaptive TRansform Acoustic Coding) is a new technology that is designed to eliminate the information in sounds which you can not hear and to compress the remaining sound data so that the recording uses about 1/5 of the original sound information. Sound data is analysed and filtered to take advantage of psycho acoustic masking. The acoustic quality of the sound is not impaired.

■ Types of discs

There are two types of discs: playback-only and recordable types.

● Playback-only MiniDisc:

This type of MiniDisc is used for commercially available prerecorded music. This is the same kind of optical disc as CDs. Playback is performed using an optical pickup. (Recording and editing are not possible.)

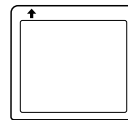

A Shutter will be used on only one side (back).

● Recordable MiniDisc:

This is a "raw disc" on which recording can be performed. A magneto optical disc is used. Recordings are made using a laser and magnetic field. Repeated recording is possible.

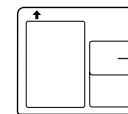

Shutters will be used on both sides.

■ How to apply labels

When sticking a label on a MiniDisc cartridge, be sure to observe the following. If a label is not affixed properly, a MiniDisc may become jammed in the unit such that it can not be removed.

- Stick a label correctly to the specified area. (Do not stick labels to areas other than the specified one.)
- Do not stick one label upon another.
- If a label is peeling off or starts to come loose, replace it with a new one.

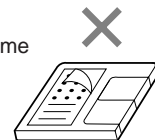

■ Shock Resistant Memory

During playback, approximately 10 seconds of information is stored in the semiconductor memory. Therefore, even when the pickup cannot read information for a second or two due to an external shock, the sound continues without interruption because the information stored in memory is output.



MINIDISC SYSTEM LIMITATIONS

Even if the maximum recording time of a MiniDisc has not been reached, "TOC FULL" may be displayed.	In the MD system, the delimiter of the recording area on a MiniDisc is programmed in a TOC. If partial erasing, recording and editing are repeated several times, TOC information will fill up, even though the number of tracks has not reached the limit (255 tracks), and further recording will be impossible. (If you use the all erase function, this MiniDisc can be used from the beginning.)
Even if the maximum recording time of a MiniDisc has not been reached, "DISC FULL" may be displayed.	If there is any flaw on the MiniDisc, that part is automatically excluded from the space available for recording. Therefore, the recording time becomes shorter.
Even if several short tracks are erased, the remaining recording time may not show an increase.	When the remaining recording time of a disc is displayed, short tracks less than 12 seconds long may not be included in the total.
Two tracks may not be combined in editing.	For MiniDiscs on which repeated recording and editing operations were performed, the COMBINE function may not work. A track recorded from a CD (digital recording) and a track recorded from a radio or other equipment (analogue recording) cannot be combined.
The total of the recorded time and time remaining on a disc may not add up to the maximum possible recording time.	A cluster (about 2 seconds) is normally the minimum unit of recording. So, even if a track is less than 2 seconds long, it will use about 2 seconds of space on the disc. Therefore, the time actually available for recording may be less than the remaining time displayed. If there are scratches on discs, those sections will be automatically avoided (no recording will be placed in those sections). Therefore, the recording time will be reduced.
If recorded tracks are fast reversed or fast forwarded, the sound may skip.	A MiniDisc which has been recorded or edited repeatedly may skip during fast reverse or fast forward.

TROUBLESHOOTING

■ If a problem occurs

If this unit functions abnormally during operation, first check the following items. If the unit continues to function abnormally, or if an abnormality appears other than listed below, set this unit to the stand-by mode and disconnect the AC power plug, then consult your SHARP dealer or service personnel.

General

Symptom	Possible cause	Remedy
● The clock is wrong.	● Did a power failure occur?	● Try setting it again.
● When a button is pressed, the unit does not respond.	_____	● Set this unit to the stand-by mode and then turn it back on. Then, retry the operation.
● No sound is heard.	● Is the volume level is set to "0"? ● Are the headphones connected? ● Are the speaker wires disconnected?	● Increase the volume level. ● Disconnect the headphones. ● Connect the wires securely.
● Radios make unusual noise or the picture on the TV screen is distorted.	● When a radio or TV which uses an indoor aerial is placed near the unit, the picture on the TV screen may be distorted or the radio may not function properly.	● It is recommended that you use an external aerial.

CD Playback

Symptom	Possible cause	Remedy
● Even though a disc has been loaded, "NO DISC" is displayed. ● Playback stops in the middle of a track, or playback is not performed properly. ● Playback sounds are skipped.	● The disc is loaded up-side down. ● The disc is very dirty. ● The disc does not satisfy the standards. ● Is the unit located near excessive vibrations? ● Has condensation formed inside the unit?	● Load the disc with the correct side up. ● Clean the disc. ● Load the correct disc. ● Place the unit on a firm, level surface free from vibration. ● Remove the disc and leave the power turned on. The unit should function properly in about 1 hour.



(Continued)

MiniDisc recording and playback

Symptom	Possible cause	Remedy
<ul style="list-style-type: none"> ● A recording cannot be made. 	<ul style="list-style-type: none"> ● Is the MiniDisc protected against accidental erasure? ● Did you try to make recording on a playback-only MiniDisc? ● Can you see the "DISC FULL" or "TOC FULL" message in the display? 	<ul style="list-style-type: none"> ● Slide the accidental erase prevention tab back to its original position. ● Replace it with a recordable disc. ● Put in another recordable disc with recording space on it.
<ul style="list-style-type: none"> ● Even though a disc has been loaded, "NO DISC" or "CAN'T READ" is displayed. ● Playback sounds are skipped. 	<ul style="list-style-type: none"> ● The disc is very dirty. ● Is the unit located near excessive vibrations? ● Has condensation formed inside the unit? 	<ul style="list-style-type: none"> ● Clean the disc. ● Place the unit on a firm, level surface free from vibration. ● Remove the disc and leave the power turned on. The unit should function properly in about 1 hour.

Radio reception

Symptom	Possible cause	Remedy
<ul style="list-style-type: none"> ● Radios make unusual noise consecutively. 	<ul style="list-style-type: none"> ● The unit is placed near the TV or computer. ● The aerial direction is not placed properly. 	<ul style="list-style-type: none"> ● When the unit receives a radio broadcast near a TV set, a computer or a word-processor, it may pick up noise. If this happens, move the unit from the place where the noise is picked up. ● Correct the aerial direction.
<ul style="list-style-type: none"> ● The preset channel cannot be recalled. 	<ul style="list-style-type: none"> ● Did you erase the programmed station? 	<ul style="list-style-type: none"> ● Preset the channel again. ● Redo programming.

Remote control

Symptom	Possible cause	Remedy
<ul style="list-style-type: none"> ● The remote control does not function or does not operate properly. 	<ul style="list-style-type: none"> ● The batteries (polarity) are not inserted properly. ● The batteries inside the remote control are dead. ● The remote control is operated from an incorrect distance or angle. 	<ul style="list-style-type: none"> ● Insert properly. ● Replace the batteries. ● Operate it within a range of 0.2 m (8") to 6 m (20') and within an angle of 15 ° to either side of centre.
<ul style="list-style-type: none"> ● The power cannot be turned on from the remote control. 	<ul style="list-style-type: none"> ● Is the AC power lead plugged in? 	<ul style="list-style-type: none"> ● Connect the AC power lead.

RESETTING THE MICROCOMPUTER

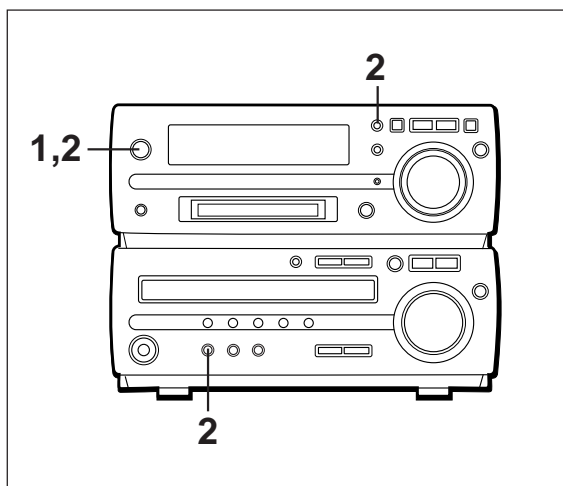

If this product is subjected to strong external interference (mechanical shock, excessive static electricity, abnormal supply voltage due to lightning, etc.) or if it is operated incorrectly, it may malfunction or the display may not function correctly. If such a problem occurs, do the following:

- 1 Press the ON/STANDBY button to enter the stand-by mode.**
- 2 Press the ON/STANDBY button whilst holding down the SURROUND button and the TIMER/DELETE button.**
 - "ALL CLEAR" will appear.

Caution:

- The operation explained above will erase all data stored in memory including clock and timer settings, and tuner, MiniDisc and CD presets.



ERROR MESSAGES

When an error message is displayed, proceed as follows:

Error messages	Meaning	Remedy
BLANK MD	<ul style="list-style-type: none"> ● Nothing is recorded. (Neither music nor disc name is recorded.) 	<ul style="list-style-type: none"> ● Replace it with another disc.
CAN'T COPY	<ul style="list-style-type: none"> ● You tried to record from a copy prohibited CD. 	<ul style="list-style-type: none"> ● Replace the CD.
CAN'T READ * (* :Number or symbol)	<ul style="list-style-type: none"> ● The disc is damaged. ● TOC information cannot be read. ● MiniDisc not specified. 	<ul style="list-style-type: none"> ● Replace it with another disc. ● Erase the disc and try recording again.
CAN'T EDIT	<ul style="list-style-type: none"> ● A track cannot be edited. 	<ul style="list-style-type: none"> ● Change the stop position of the track and then try editing it.
CAN'T REC	<ul style="list-style-type: none"> ● Recording cannot be performed correctly due to vibration or shock in the unit. 	<ul style="list-style-type: none"> ● Re-record or replace the MiniDisc.
CAN'T WRITE	<ul style="list-style-type: none"> ● The TOC information could not be created properly due to a mechanical shock or to scratches on the disc. 	<ul style="list-style-type: none"> ● Set this unit to the stand-by mode and try to write the TOC again. (Remove any source of shock or vibration whilst writing.)
DISC FULL	<ul style="list-style-type: none"> ● The disc is out of recording space. 	<ul style="list-style-type: none"> ● Replace the disc with another recordable disc.
E-CD 20	<ul style="list-style-type: none"> ● The CD tray is not working properly. 	<ul style="list-style-type: none"> ● Set this unit to the stand-by mode and turn the power on again.
E. OVER	<ul style="list-style-type: none"> ● You chose 21 or more tracks for track editing. 	<ul style="list-style-type: none"> ● Decrease the number of tracks.
EDIT OVER	<ul style="list-style-type: none"> ● There is no space to make CD editing on the disc. 	<ul style="list-style-type: none"> ● Replace it with a disc that has enough time to record.
Er-MD ** (* :Number or symbol)	<ul style="list-style-type: none"> ● A MiniDisc is not working properly. 	<ul style="list-style-type: none"> ● Set this unit to the stand-by mode and turn the power on again.
NAME FULL	<ul style="list-style-type: none"> ● The number of characters for the disc name or track name exceeds 40. 	<ul style="list-style-type: none"> ● Shorten the disc or track name.
NO DISC	<ul style="list-style-type: none"> ● A MiniDisc has not been loaded. ● The MiniDisc data cannot be read. ● A CD has not been loaded. ● The CD data cannot be read. 	<ul style="list-style-type: none"> ● Load a MiniDisc. ● Reload the MiniDisc. ● Load a CD. ● Reload the CD.
NOT AUDIO	<ul style="list-style-type: none"> ● The data recorded on this disc is not audio data. 	<ul style="list-style-type: none"> ● Select another track. ● Replace the disc.
PLAY MD	<ul style="list-style-type: none"> ● You tried to record on a playback-only disc. 	<ul style="list-style-type: none"> ● Replace it with another recordable disc.
PROTECTED	<ul style="list-style-type: none"> ● The disc is write protected. 	<ul style="list-style-type: none"> ● Move the write protection tab back to its original position.
TEMP OVER	<ul style="list-style-type: none"> ● The temperature is too high. 	<ul style="list-style-type: none"> ● Set this unit to the stand-by mode and wait for a while.
TOC FORM ** (* :Number or symbol)	<ul style="list-style-type: none"> ● TOC information recorded on the MD does not match the MiniDisc specifications or it cannot be read. 	<ul style="list-style-type: none"> ● Replace it with another disc. ● Erase the disc and try recording again.
TOC FULL	<ul style="list-style-type: none"> ● There is no space left for recording track numbers. 	<ul style="list-style-type: none"> ● Replace it with another recordable disc.
TOC FULL 1	<ul style="list-style-type: none"> ● There is no space left for recording character information. 	<ul style="list-style-type: none"> ● Replace it with another recordable disc. ● Erase the needless characters.
? DISC	<ul style="list-style-type: none"> ● The data contains an error. ● MiniDisc not specified. 	<ul style="list-style-type: none"> ● Replace it with another disc.



MAINTENANCE

External care

- Periodically wipe the cabinet with a soft cloth and a diluted soap solution, then wipe with a dry cloth.
- Do not use chemically treated cleaning cloths or other chemicals.

SPECIFICATIONS

As part of our policy of continuous improvement, SHARP reserves the right to make design and specification changes for product improvement without prior notice. The performance specification figures indicated are nominal values of production units. There may be some deviations from these values in individual units.

General

Power source:	AC 230 V, 50 Hz
Power consumption:	70 W
Dimensions:	Width; 215 mm (8-1/2") Height; 162 mm (6-7/16") Depth; 344 mm (13-9/16")
Weight:	4.7 kg (10.4 lbs.)

Amplifier section

Output power:	RMS; 50 W (25 W+25 W) (10% T.H.D.)
Output terminals:	Speaker; 6 ohms Headphones; 16 - 50 ohms (recommended 32 ohms)
Input terminals:	Auxiliary; 500 mV/47 k ohms

MiniDisc recorder section

Type:	MiniDisc recorder
Signal readout:	Non-contact, 3-beam semiconductor laser pickup
Rotation speed:	400 - 900 rpm CLV, Approx.
Error correction:	ACIRC (Advanced Cross Interleave Reed-Solomon Code)
Quantization:	20-bit linear (A/D converter)
Coding:	ATRAC (Adaptive Transform Acoustic Coding)
Sampling frequency:	44.1 kHz
Recording method:	Magnetic modulation overwrite method
Frequency response:	20 - 20,000 Hz
D/A converter:	1-bit D/A converter
Wow and flutter:	Unmeasurable (less than 0.001% W. peak)
Signal/noise ratio:	95 dB (1 kHz)
Dynamic range:	90 dB (1 kHz)
Audio channel:	Stereo; 2 channels Monaural; 1 channel (playback only) (long-time recording mode)

Compact disc player section

Type:	Drawer type compact disc player
Signal readout:	Non-contact, 3-beam semiconductor laser pickup
Rotation speed:	200 - 500 rpm CLV, Approx.
Error correction:	CIRC (Cross Interleave Reed-Solomon Code)
Quantization:	16-bit linear
Frequency response:	20 - 20,000 Hz
D/A converter:	1-bit D/A converter
Signal/noise ratio:	95 dB (1 kHz)
Dynamic range:	90 dB (1 kHz)
Wow and flutter:	Unmeasurable (less than 0.001% W. peak)

Tuner section

Frequency range:	FM; 87.5 - 108.0 MHz AM; 522 - 1,620 kHz
Sensitivity:	FM; 2.5 μ V (75 ohms unbalanced) AM; 650 μ V/m

Speaker section

Type:	2-way speaker system [12cm (4-3/4") woofer and 2cm (3/4") tweeter]
Maximum input power:	50 W
Rated input power:	25 W
Impedance:	6 ohms
Dimensions:	Width; 160 mm (6-5/16") Height; 280 mm (11-1/16") Depth; 233.5 mm (9-1/4")
Weight:	3.2 kg (7.1 lbs.)/each



TERMS OF GUARANTEE

Sharp Electronics (UK) Ltd. ("Sharp") guarantees to provide for the repair, or at its option the replacement, of this product subject to the conditions listed below:-

1. This guarantee shall only apply to faults which are due to inferior workmanship or materials. It does not cover faults or damage caused by accident, misuse, fair wear and tear, neglect, tampering with the product, or repair other than by a Service Facility appointed by Sharp.
2. As this product is intended for private domestic use only, the guarantee will not apply if the product is used in the course of a business, trade or profession.
3. To benefit from this guarantee, any fault which occurs must be notified to Sharp, or its appointed Service Facility within one year from the date this product was purchased. Proof of purchase must be provided.
4. The guarantee does not cover carriage costs, jewelled styli, audio tapes, compact discs or batteries.
5. In the unlikely event of this product requiring repair, please contact the supplier from whom it was purchased. Where this is not possible, please contact the Sharp Customer Information Centre on the telephone number given below.
6. No person has any authority to vary the terms or conditions of this guarantee.
7. This guarantee is offered as an additional benefit to your statutory rights, and does not affect these rights in any way.

If you have any difficulty operating this product, or would like information on other Sharp products, please telephone the Sharp Customer Information Centre on the number given below.

Sharp Customer Information Centre - Telephone 0345 125387

SHARP

SHARP ELECTRONICS (U.K.) LTD.

Sharp House, Thorp Road, Newton Heath, Manchester, M40 5BE

SHARP CORPORATION

TINSE0270AWZZ

A0001.YT