

Notice for All Users

- Consult the operation manual for proper use of your computer.
- The product and the accessories are subject to change without prior notice.
- SHARP assumes no guarantee for results arising from use of pre-installed and third party software. Consult the software vendor for resolution of problems.
(Read the service condition of the software before use.)
- SHARP assumes no responsibility for problems caused by incorrect handling, repairs, defects, battery replacement or any other cause.

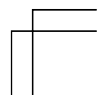

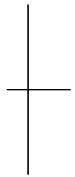
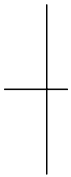

Notice for Users in the USA

FCC Statement

WARNING - FCC Regulations state that any unauthorized changes or modifications to these equipments not expressly approved by the manufacturer could void the user's authority to operate these equipments.

Note: These equipments have been tested and found to comply with the limits for a Class B digital device pursuant to Part 15 of the FCC Rules.

These limits are designed to provide reasonable protection against harmful interference in a residential installation. These equipments generate, use and can radiate radio frequency energy and, if not installed and used in accordance with the instructions, may cause harmful interference to radio communications. However, there is no guarantee that interference will not occur in a particular installation. If these equipments do cause harmful interference to radio or television reception, which can be determined by turning the equipments off and on, the user is encouraged to try to correct the interference by one or more of the following measures:

- Reorient or relocate the receiving antenna.
- Increase the distance between the equipment and receiver.
- Connect the equipment into an outlet on a circuit different from that to which the receiver is connected.
- Consult the dealer or an experienced radio/TV technician for help.

A shielded I/F cable is required to insure compliance with FCC regulation for Class B computing equipment.



* As an ENERGY STAR® Partner, SHARP has determined that this product meets the ENERGY STAR® guidelines for energy efficiency.

Declaration of Conformity

SHARP PERSONAL COMPUTER, PC-MM Series

This device complies with part 15 of the FCC rules. Operation is subject to the following conditions: (1) this device may not cause harmful interference, and (2) this device must accept any interference received, including interference that may cause undesired operation.

Responsible Party: SHARP ELECTRONICS CORPORATION
Sharp Plaza, Mahwah, New Jersey 07430-2135
TEL: 1-800-BE-SHARP



FCC Radiation Exposure Statement

The available scientific evidence does not show that any health problems are associated With using low power wireless devices. There is no proof, however, that these low power wireless devices are absolutely safe. Low power Wireless devices emit low levels of radio frequency energy (RF) in the microwave range while being used. Whereas high levels of RF can produce health effects (by heating tissue), exposure to low level RF that does not produce heating effects causes no known adverse health effects. Some studies have suggested that some biological effects might occur, but such findings have not been confirmed by additional research. PC-MM20 has been tested and found to comply with the Federal Communications Commission (FCC) guidelines on radio frequency energy (RF) exposure. The maximum SAR levels tested for the PC-MM20 has been shown to be 0.01 W/kg at Body.

Notice for PC Card Modem

FCC Part 15 Subpart B Statement

WARNING - FCC Regulations state that any unauthorized changes or modifications to this equipment not expressly approved by the manufacturer could void the user's authority to operate this equipment.

Note: This equipment has been tested and found to comply with the limits for a Class B digital device pursuant to Part 15 of the FCC Rules.

These limits are designed to provide reasonable protection against harmful interference in a residential installation. This equipment generates, uses and can radiate radio frequency energy and, if not installed and used in accordance with the instructions, may cause harmful interference to radio communications. However, there is no guarantee that interference will not occur in a particular installation. If this equipment does cause harmful interference to radio or television reception, which can be determined by turning the equipment off and on, the user is encouraged to try to correct the interference by one or more of the following measures:

Reorient or relocate the receiving antenna.

Increase the distance between the equipment and receiver.

Connect the equipment into an outlet on a circuit different from that to which the receiver is connected.

Consult the dealer or an experienced radio/TV technician for help.

Declaration of Conformity

Zoom PC Card Modem: Model 1273



This device complies with part 15 of the FCC rules. Operation is subject to the following conditions : (1) this device may not cause harmful interference, and (2) this device must accept any interference received, including interference that may cause undesired operation.

Responsible Party: Zoom Telephonics, INC
207 South Street Boston, MA 02111
TEL: 617-423-1072

FCC Part 68 Statement

This equipment complies with Part 68 of the FCC rules. On the bottom of this equipment is a label that contains, among other information, the FCC registration number and ringer equivalent number (REN) for this equipment. If requested, this number must be provided to the telephone company.



The modem jack of this equipment complies with Sub-part F of Part 68 of FCC rules.



The REN is used to determine the quantity of devices which may be connected to the telephone line. Excessive RENs on the telephone line may result in the devices not ringing in response to an incoming call. In most, but not all areas, the sum of the RENs should not exceed five (5.0). To be certain of the number of devices that may be connected to the line, as determined by the total RENs contact the telephone company to determine the maximum REN for the calling areas.

If the terminal equipment causes harm to the telephone network, the telephone company will notify you in advance that temporary discontinuance of service may be required. But if advance notice isn't practical, the telephone company will notify the customer as soon as possible. Also, you will be advised of your right to file a complaint with the FCC if you believe it necessary.

The telephone company may make changes in its facilities, equipment, operations, or procedures that could affect the operation of the equipment. If this happens, the telephone company will provide advance notice in order for you to make the necessary modifications in order to maintain uninterrupted service.



If trouble is experienced with this equipment, please contact Zoom Telephonics, Inc. for repair and (or) warranty information (Refer to the provided Consumer Limited Warranty sheet). If the trouble is causing harm to the telephone network, the telephone company may request you remove the equipment from the network until the problem is resolved.

The equipment cannot be used on public coin service provided by the telephone company. Connection to Party Line Service is subject to state tariffs. (Contact the state public utility commission, public service commission or corporation commission for information.)

The Telephone Consumer Protection Act of 1991 makes it unlawful for any person to use a computer or other electronic device, including fax machines, to send any message unless such message clearly contains in a margin at the top or bottom of each transmitted page or on the first page of the transmission, the date and time it is sent and an identification of the business or other entity, or other individual sending the message and the telephone number of the sending machine or such business, other entity, or individual. (The telephone number provided may not be a 900 number or any other number for which charges exceed local or long-distance transmission charges.) To program this information, refer to the manual of the communication software.

Product Information and Customer Assistance

For Product Information and Customer Assistance:

Call: 561-997-9686

Zoom Telephonics, INC
207 South Street Boston, MA 02111

Home Page: <http://www.zoom.com>

ZOOM PCMCIA Modem card does not support Microsoft Windows XP fax send and receive functionality. For more information, please contact 1-800-BE-SHARP.

Warning

This product utilizes tin-lead solder, and fluorescent lamp containing a small amount of mercury.

Disposal of these materials may be regulated due to environmental considerations.

For disposal or recycling information, please contact your local authorities or the Electronics Industries Alliance: www.eiae.org

Copyright

It is the intent of Sharp that this product be used in full compliance with the copyright laws of the United States and that prior permission be obtained from copyright owners whenever necessary.



CAUTION:

TO PREVENT ELECTRICAL SHOCK, DISCONNECT THE AC ADAPTER AND REMOVE THE BATTERY BEFORE SERVICING.

CAUTION:

FOR A COMPLETE ELECTRICAL DISCONNECTION, UNPLUG THE POWER CORD AND THE BATTERY.

VORSICHT:

UM DIE STROMZUFUHR VOLLSTÄNDIG ZU UNTERBRECHEN, DEN NETZSTECKER HERAUSZIEHEN UND DIE BATTERIE ENTFERNEN.

ATTENTION:

POUR UN ARRET TOTAL DU SYSTEME, DECONNECTEZ LA PRISE DE COURANT SECTEUR ET LA BATTERIE.



VARNING:

FÖR TOTAL ELEKTRISK URKOPPLING, KOPPLA UR KONTAKTEN OCH TA UR BATTERIET.



PRECAUCION:

PARA UNA COMPLETA DESCONEXION ELECTRICA DESENCHUFE LA CLAVIJA DE LA RED Y LA BATERIA.





Safety Precautions

General

- Follow all cautions and instructions marked on your computer.
- Except as described elsewhere in this manual, refer all servicing to qualified personnel. Immediately shut off your computer and seek servicing under the following conditions:
 - when the power cord or plug is damaged or frayed
 - when liquid is spilled on your computer
 - when your computer has been dropped or the cabinet has been damaged

Location

- 
- 
- Do not expose your computer to direct sunlight.
 - Try to avoid dusty environments.
 - Keep your computer away from any magnetic devices and TVs.
 - Keep your computer away from heaters.
 - Keep your computer away from excessive humidity or fluids such as rain, snow, water spray, juice, coffee, steam, etc.
 - Keep your computer away from extremely high or low temperature.
 - Do not move your computer from an extremely cold place to an extremely warm place. A temperature difference of more than 18°F (10°C) will cause condensation inside the unit, which may cause damage. (In this case, turn off your computer and leave it for about an hour to completely dry the unit.)
 - Do not block or cover slots or openings on the cabinet. They protect your computer from overheating.
 - Do not place your computer on an unstable or uneven work surface.
 - Care should be exercised when using on heat sensitive surfaces or your lap as the base of your computer will get hot.
 - Do not use your computer on your lap or any part of your body for an extended period during operation or charging to avoid injury from heat exposure.

Usage

- Never push any objects into cabinet openings. They may touch dangerous voltage points or short parts that could result in fire or electrical shock.
- Do not press or place heavy objects on your computer. Strong pressure can damage the cabinet or make your computer fail.
- If your computer or the AC power cord experiences an abnormal situation such as heat generation or smoking, or produces an abnormal odor, turn off your computer, unplug the power cord, and remove the battery pack immediately.
- Turn off your computer before installing or removing any peripheral devices except when connecting USB devices, a PC card, etc.

- Never subject your computer to sudden shocks or extreme vibration.
- Do not drop your computer or hit it with other equipment.
- Do not scratch the surface of the LCD screen.
- Turn off your computer and disconnect the AC power cord before cleaning.

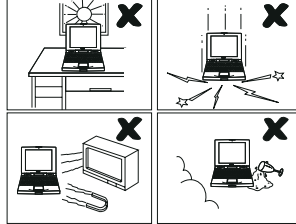

- When carrying your computer:
 - Turn off your computer.
 - Remove external media such as a PC card from the slot.
 - Disconnect the external peripherals, cables and cords if connected.
 - Do not give shock to your computer.
 - Do not hold the display unit.

Otherwise, the hard disk may fail or the stored data might be lost.

Battery Pack Precautions

CAUTION

DANGER OF EXPLOSION IF BATTERY IS INCORRECTLY REPLACED.
 REPLACE ONLY WITH THE SAME OR EQUIVALENT TYPE
 RECOMMENDED BY THE MANUFACTURER. DISCARD USED BATTERIES
 ACCORDING TO THE MANUFACTURER'S INSTRUCTIONS.

Handling

- Never put the battery pack in a fire, as it could explode and cause injury.
- Do not attempt to open or alter the battery pack.
- Do not place the battery pack where it might get hotter than 140°F (60°C).
- The battery pack must be kept from metal objects such as jewelry and liquids. They might trigger a short circuit and consequently cause the battery pack to heat up and explode.
- Do not allow liquids to come in contact with the battery pack.
- Care must be taken not to drop the pack. A violent shock damages the pack.
- Do not solder anything to the battery terminals.



Charging

- Charge the battery pack only with the AC adapter and AC power cord included with your computer.



Discharging

- Do not use the battery pack for any other purpose than powering your computer.

Storage

- Store the battery pack in a cool and dry place. Do not store it at temperatures above 140°F (60°C).
- Recharge the stored battery pack before using it.

AC Power Precautions

- 
- 
- Plug the AC power cord directly in the wall jack. Plugging too many leads into a single socket may result in fire.
 - Never plug in or remove the AC power cord or AC adapter with wet hands for prevention of electric shock.
 - The included AC power cord must be appropriate for the voltage used in your area. Using an inappropriate cord can cause fire.
 - Unplug the AC power cord when not using your computer for a long period.
 - Never disassemble, repair, or modify the AC adapter.
 - Never modify, twist, forcibly bend or pull, or place heavy objects on top of the AC cord to avoid damaging it. Using a damaged cord can cause fire or electric shock.
 - Be sure to hold the plug of the AC power cord when removing it from a wall socket.
 - Check the AC power cord and power connectors periodically for damage. Change the power cord immediately if damage is found.

Modem Precautions

IMPORTANT SAFETY INSTRUCTIONS

When using your telephone equipment, basic safety precautions should always be followed to reduce the risk of fire, electric shock and injury to persons, including the following:

- Do not use this product near water, for example, near a bath tub, wash bowl, kitchen sink or laundry tub, in a wet basement or near a swimming pool.
- Avoid using a telephone (other than a cordless type) during an electrical storm. There may be a remote risk of electric shock from lightning.
- Do not use the telephone to report a gas leak in the vicinity of the leak.
- Never install telephone wiring during lightning storms.

- During thunder storms, you should turn off your computer, unplug the AC power cord and remove the modem cable from your computer.
- Never install telephone jacks in wet locations unless the jack is specifically designed for wet locations.
- Never touch uninsulated telephone wires or terminals unless the telephone line has been disconnected at the network interface.
- Use caution when installing or modifying telephone lines.

Wireless LAN Precautions

- Disable the integrated antenna and do not communicate with wireless LAN in specific environments where radio-susceptible equipment is nearby, on airplanes, in hospitals, for example.
- Disable the integrated antenna and do not communicate with wireless LAN in crowded places for prevention of cardiac pacemaker interference.
- Maintain a space of at least 8.66" (22cm) between a cardiac pacemaker and an active wireless LAN antenna.
- Never disassemble or alter the wireless LAN unit.
- Do not remove the certification label on the wireless LAN unit.

Product Conformance

The wireless LAN unit equipped with your computer is in conformance with federal requirements. No license is required for use of the device.

Notice of Radio Interference

The wireless LAN card equipped with your computer operates at 2.4GHz that is also used for microwaves, science or medical devices, other similar radio stations (hereafter called "other radio stations"), etc.

- Prior to using the wireless LAN function with your computer, confirm that no "other radio stations" are operating nearby.
- If interference with "other radio stations" is experienced, change the current channel set to your computer or move your computer. If it fails, stop operating.



PC Disposal or Transfer



Prior to the disposal or transfer of your computer, you should erase the data from hard disks.

To remove the data from your hard disk drive, you will need to:

- “Delete” the data by placing it in your recycle bin.
- Empty the recycle bin.
- Format the hard drives.
- Recover the system.

The above procedures do not completely delete all data from your hard disks. When a file is deleted, the disk location where it is stored is marked as unallocated space available for new data. However, the old data is still there and can be recovered unless new data is written. Because of the reason, malicious persons can recover the “deleted” data and misuse it. To avoid the data spillage, users must thoroughly erase all the data from the hard disks.

The following measures are recommended for permanent data deletion:

- 
- 
- Use special software or paid services for thoroughly erasing data
 - Hammer, or strongly magnetize, the hard disk to destroy the stored data

Be sure to delete the software, such as operating system(s) or applications, on your hard disk when transferring your computer, to avoid conflict with the software agreement(s).

Other Precautions

- Periodic back-up copies of your important data should be made to protect your data in the event of hard disk failure or loss of the data. Use other storage devices for the backup.
(Data loss or alternation can be caused by: malfunction, repair or misuse of your computer: improper change of the battery pack: damage by static electricity or electrical noise.)

- Your computer is integrated with a magnet on the right side of the display. Be sure to keep magnetic cards and floppy disks away from the right side of your computer to prevent the data on the cards or floppy disks from being erased.

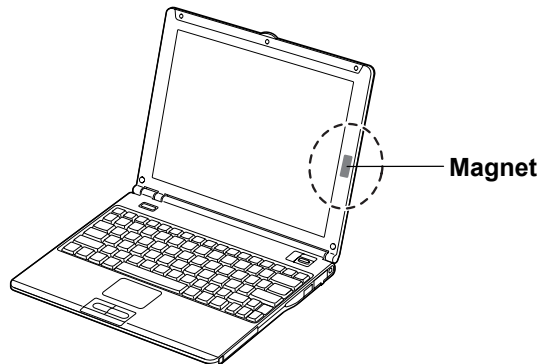

- This computer has a sensor on the right side of the keyboard that responds to the magnet. If the magnet gets close to the sensor:
 - The backlight will be turned off.
 - The system may enter the standby or the hibernate mode depending on the setting. (See Chapter 3.)

For Your Health

- Take regular breaks of ten to fifteen minutes after every hour of continuously viewing the screen to relieve your eyes.
- Adjust the brightness for comfortable viewing. (Brightness level of about 500 lux is recommended.)
- Do not use your computer in an environment where sunlight or indoor lighting reflects off the screen.
- Position the display slightly below eye level and give a space of 15.7" (40cm) through 23.6" (60cm) between you and the display.





Notice of Security with Wireless Devices

Wireless LAN provides data transfer by means of electric waves instead of LAN cables between communicating devices such as personal computers and a wireless LAN station. Wireless LAN has an advantage of simple and ubiquitous LAN connection in the ranges where electric waves are available.

Since electric waves can penetrate through walls and reach everywhere, wireless LAN includes some security threats and can produce the situations mentioned below without proper security settings.

- Eavesdropping
Malicious third parties can intercept the transmission and monitor your mail to obtain personal information such as an identification number, password, and credit card number.
- Intruding
Malicious third parties can connect to a personal or office network without authorization and illegally perform the following:
 - Obtaining access to confidential customer records or sensitive corporate information (Information leakage)
 - Faking the original information (Spoofing)
 - Altering the monitored original data and transmitting (Falsification)
 - Spreading computer viruses resulting in the destruction of data or systems (Destruction)



Although wireless LAN cards and wireless LAN stations (Access Points) have security measures against the threats above, no security settings may have been configured at the time of purchase.

All security features must be configured according to reference manuals of the wireless LAN devices, which results in reduced opportunities for the situations described above.

Use with a clear understanding that wireless LAN includes vulnerabilities that could allow attackers to simply bypass security features.

Security measures are important for all users to understand for a safe use of wireless LAN. SHARP encourages all users to configure the security settings with their own judgment and responsibility.



About This Manual

Notice

Information in this manual is subject to change without notice and does not represent a commitment on the part of SHARP Corporation and its sales subsidiaries.

SHARP Corporation and its sales subsidiaries shall not be liable for technical or editorial errors or omissions contained herein; nor for incidental or consequential damages resulting from the furnishing, performance, or use of this material.

SHARP strongly recommends that separate permanent written records be kept of all important data. Data may be lost or altered in virtually any electronic memory product under certain circumstances. Therefore, SHARP assumes no responsibility for data lost or otherwise rendered unusable whether as a result of improper use, repairs, defects, battery replacement, use after the specified battery life has expired, or any other causes.

SHARP assumes no responsibility directly or indirectly, for financial losses or claims from third persons resulting from the use of this product and any of its functions, such as stolen credit card numbers, the loss of or alteration of stored data, etc.

Copyright

© 2004 SHARP Corporation

This document contains or refers to proprietary information which is protected by copyright. All rights are reserved. Copying or other reproduction of this document is prohibited without the prior written permission of SHARP Corporation.

Trademarks

Transmeta and Efficeon are trademarks of Transmeta Corporation.

ATI and Mobility RADEON are trademarks of ATI Technologies Inc.

IBM is a registered trademark of International Business Machines Corporation.

Microsoft and Windows are registered trademarks of Microsoft Corporation in the United States and other countries.

Power Quest is a registered trademark and EasyRestore is a trademark of PowerQuest Corporation.

BAPCo is a registered trademark of the Business Applications Performance Corporation.

MobileMark is a trademark of the Business Applications Performance Corporation.

All other brand and product names are trademarks or registered trademarks of their respective holders.



Recording Important Information

For future reference, please record the following information in the spaces provided below.

Model Number:

Serial Number:

Date of purchase:

Dealer's Name:

Place of purchase:

Password:



The serial number is printed on a sticker located on the bottom of the computer.

Manual Conventions

This manual uses a set of style conventions described below.

Notes and Cautions are italicized with icons:



A note icon informs you of a special technique or information that may help you perform a task or better understand a process.



A caution icon alerts you to something that may cause problems or damage to hardware, software or data.

Key Labels on the Keyboard, when referred to in the instructions, are shown in boldface:

Press **Enter** to continue.

When two or more keys are separated by a plus (+) sign, press and hold down the first key(s), and then press the second key:

Run *Task Manager* by pressing **Ctrl+Alt+Delete**.

Sample Entries are shown in lower cases of different typeface.

`c:\windows\system`

Words/Texts on Screen, such as window titles or possible parameters, are italicized:

Double-click this icon to display the *Power Options Properties* dialog box.

Set the item to *Enabled*.

Screens reproduced in this manual may differ slightly from the screens you see on your computer.

Section Titles in other parts of this manual are italicized:

Refer to *Installing Battery Pack* section of Chapter 1.

Table of Contents

Notice for All Users	i
Notice for Users in the USA.....	ii
Notice for PC Card Modem.....	iv
Safety Precautions	viii
Notice of Security with Wireless Devices.....	xiv
About This Manual.....	xv
Recording Important Information.....	xvi
Manual Conventions.....	xvii
Table of Contents	xiii
Overview of Computer.....	xxi

Quick Setup

Installing Battery Pack	1-1
Connecting to AC Power Source.....	1-4
Setting Up Windows	1-6
Turning Off Your Computer	1-8

Basic Operations

Choosing Power Source	2-1
Resetting System	2-3
Using Glide Pad	2-4
Using Keyboard.....	2-7
Controlling Volume.....	2-8
Adjusting Display.....	2-10
Sharing Your Computer	2-12

Battery and Power Management

Battery Pack	3-1
Power Management.....	3-8

Peripherals

Peripheral Device Connectors	4-1
Optional External Floppy Disk Drive Unit	4-3
Optional External CD-ROM Drive Unit	4-6
Display	4-11
Audio System	4-15
USB Device.....	4-17
PC Card	4-18
Printer.....	4-21

Communication Functions

LAN Unit	5-1
Wireless LAN.....	5-5
Network Setup Utility	5-12
Modem Card	5-14

Setup Utility

Running Setup Utility	6-1
Main Menu.....	6-3
Advanced Menu	6-4
Security Menu	6-4
Boot Menu.....	6-6
Exit Menu.....	6-6

Connection Cradle

Overview of Connection Cradle	7-3
Connecting to Host Computer.....	7-6
Synchronizing MM series with Host Computer.....	7-11
Stopping Connection from Host Computer.....	7-15
Removing from Connection Cradle	7-17
Setting Password	7-18

Appendixes

Maintenance and Care	A-1
Virus Infection Protection	A-3
Data Backup And Restore	A-6
Re-installation Instructions.....	A-7

Troubleshooting

Common Problems	T-1
Trouble when Starting	T-2
Trouble with Display	T-3
Trouble with Keyboard/Glide Pad.....	T-4
Trouble with Floppy Disks	T-4
Trouble with Hard Disk	T-5
Trouble with CD	T-5
Trouble with Communication.....	T-5
Trouble with Peripherals	T-9
Trouble with Connection Cradle	T-10
Other Troubles.....	T-11

Index	Index-1
--------------------	----------------

Overview of Computer

Each number after an arrow indicates the page referring to the part. Actual appearance of your computer may be slightly different depending on the model.

Front

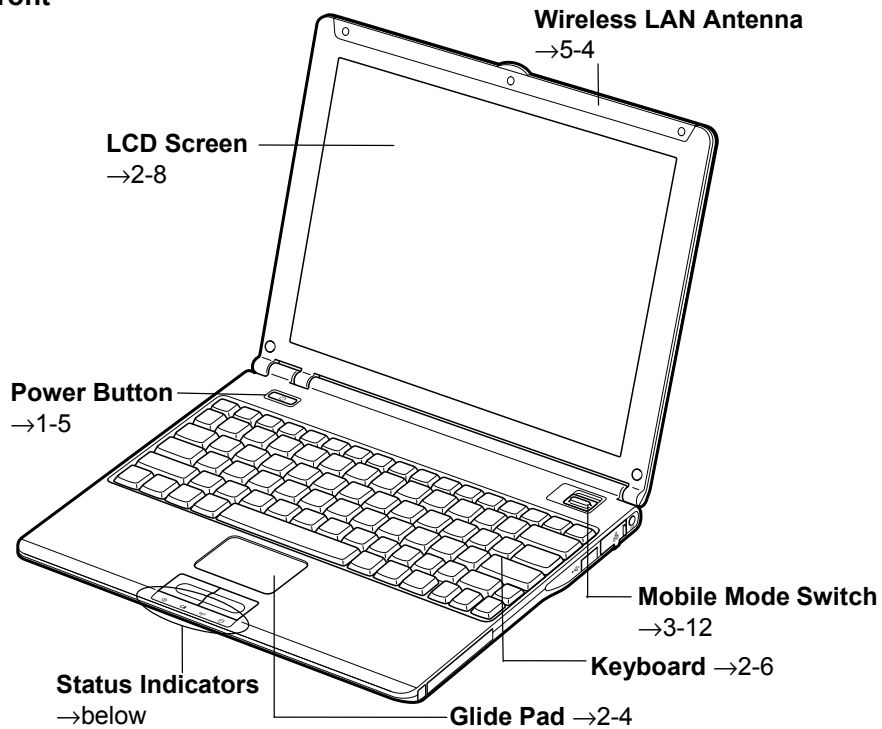

Status Indicators

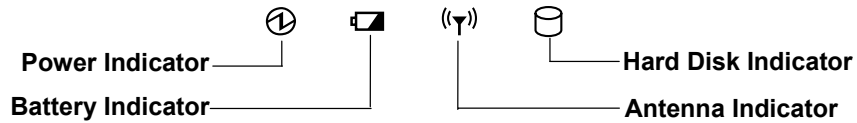

Never turn off the computer when the hard disk indicator is on. This may damage the data on the hard disk.

Right

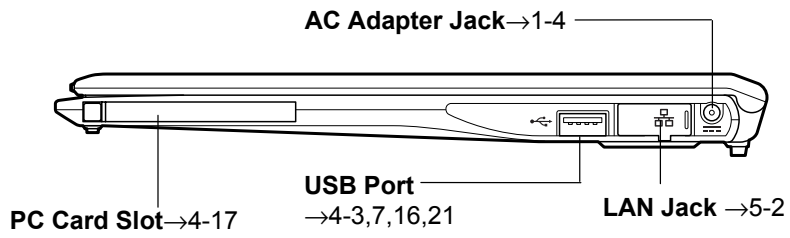

Left

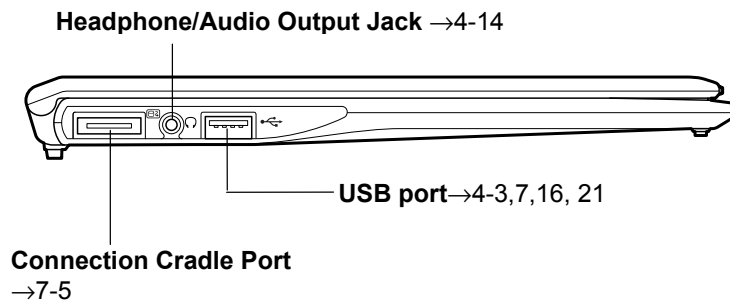

Rear

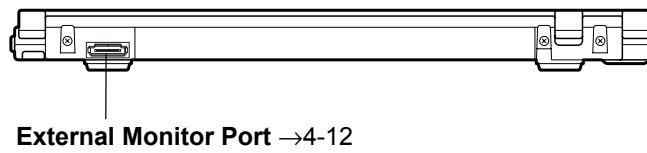

Bottom

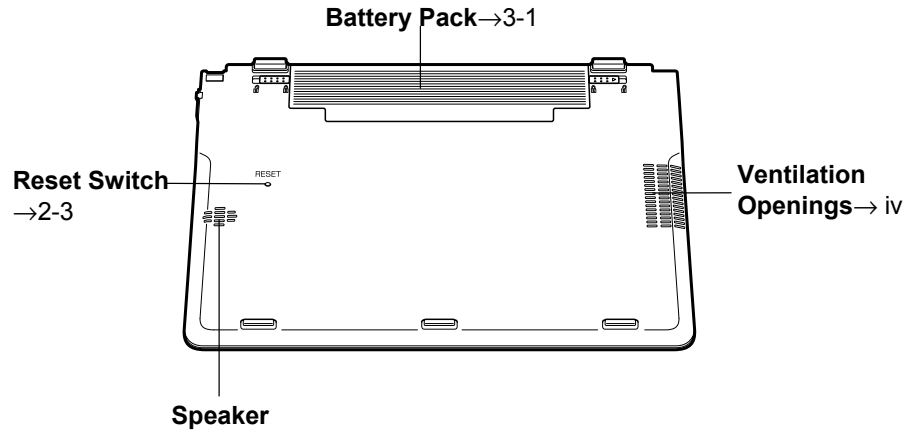

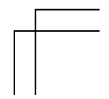
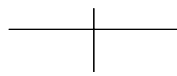
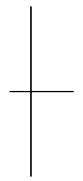
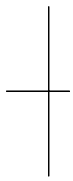
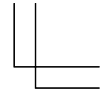

CHAPTER 1

Quick Setup

1

Your computer is designed and pre-configured for easy setup and use. This chapter describes the steps to set up your computer and operate it as quickly as possible. Read this chapter first.

Installing Battery Pack

Your computer is powered with either the battery pack or AC power source. See the next chapter for more information on the power sources. Before using your computer for the first time:

1. Place your computer upside down.
2. Slide the battery stopper of your computer to the unlocked position(Ⓐ).

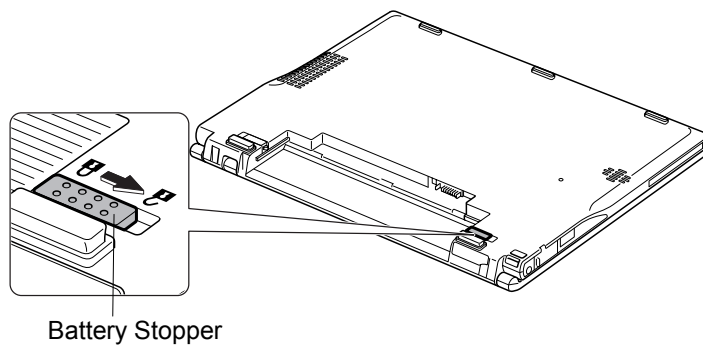

3. Insert the battery pack into your computer by matching the notched parts of the battery to the projected parts of your computer.

1

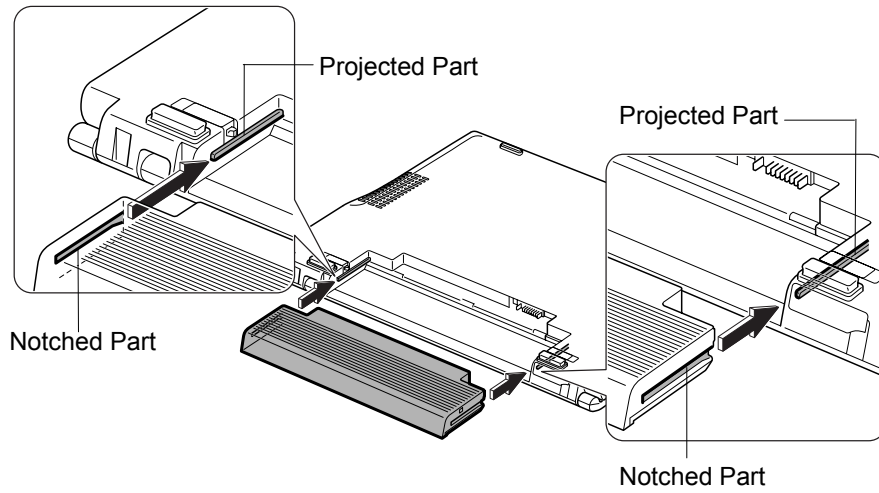

4. Push the battery pack all the way until you hear the clicking sound.

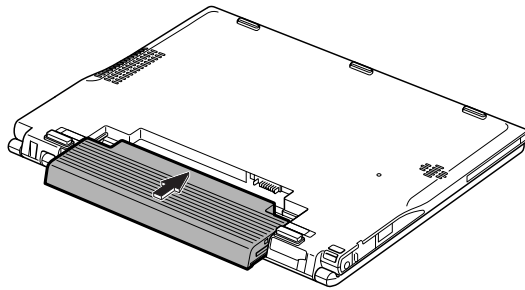

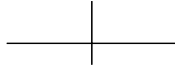

5. Slide the battery stopper to the locked position (🔒).

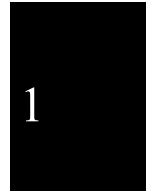
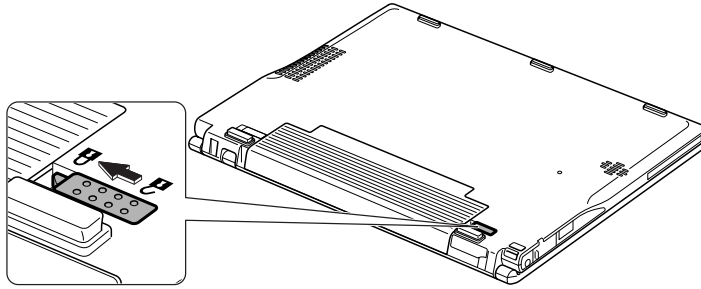

6. Turn your computer over and go to the next section.

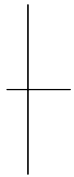
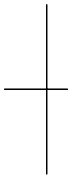

Connecting to AC Power Source

1. Plug the AC adapter cable into the AC adapter jack on the right side of your computer.
2. Plug the AC power cord into the AC adapter.
3. Plug the AC power cord into a wall outlet.

1

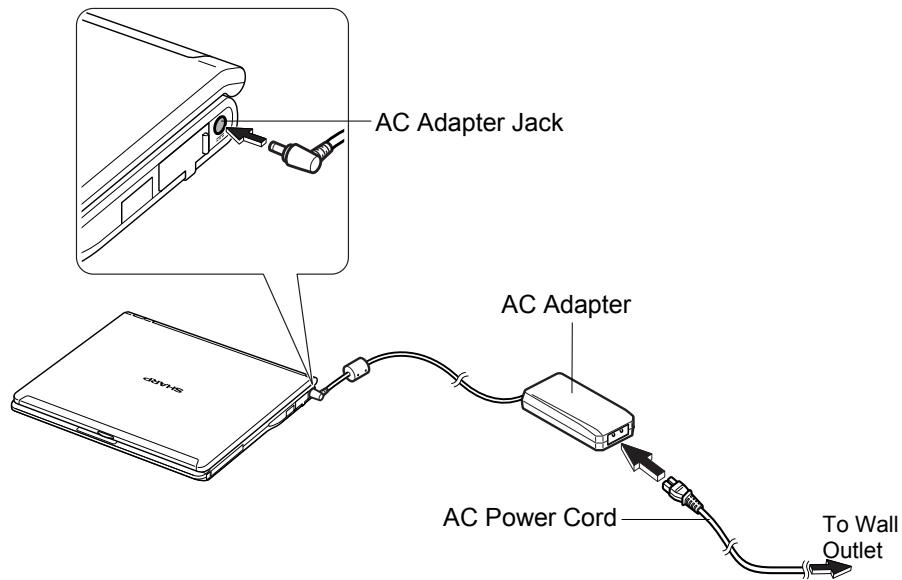

- *Always use the AC adapter and the AC power cord included with your computer or the optional one (may not be available in some countries). Using other AC adapters and AC power cords may damage your computer.*
- *Always hold the AC power cord by its plug when removing it from the wall outlet. Never pull on the cord.*
- *When using your computer for the first time, be sure to operate it on AC power. If on battery power instead, you may not be able to complete the Windows setup if the battery does not have enough power.*

4. Steady the base cabinet of your computer with your hand and hold the jtted part with your thumb or finger and then, raise the display.

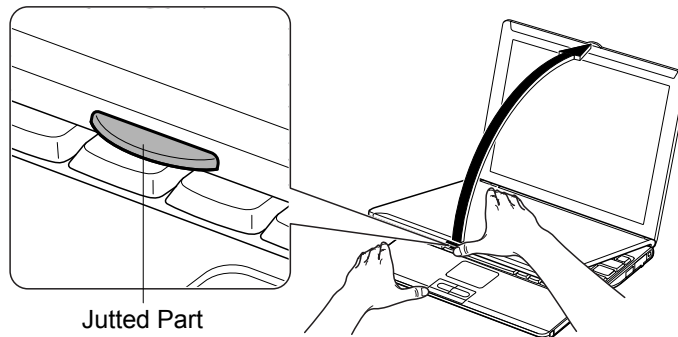

5. Press the power button to turn on your computer.

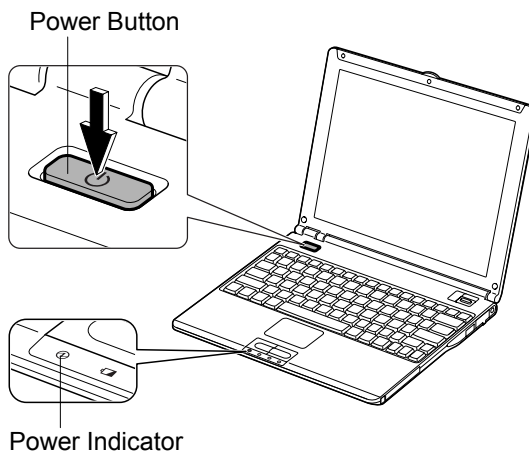

Do not touch or operate the keyboard and mouse until Windows completely activates unless you are prompted to do. Otherwise, Window may not start properly.

When you turn on your computer, the power indicator (Ⓟ) turns green, your computer goes through a self test to detect any problems, and Windows setup process starts. See the next page.

Setting Up Windows

The steps in the setup process are as follows:

1

- Configuring your location, language and keyboard type
- Configuring your time zone
- Accepting license agreement
- Naming your computer
- Creating an account
- Completing configuration

To setup Windows, follow the instructions on the screen. See also the Windows manual. It takes approximately 10-15 minutes to complete the entire setup process.



- *Do not turn off your computer until completing Windows setup. If you turn it off, you cannot set up Windows later.*
- *Be sure to connect your computer to AC power source. An undercharged battery may not be able to complete the Windows setup.*
- *Do not connect any peripheral devices to your computer until Windows setup completes. Otherwise your computer may malfunction.*



- *If the display turns off, some power management may function. In this case, press any key to resume your computer from the power management.*
- *If you cannot operate the keyboard or the touch pad, press the power button for more than four seconds to turn off your computer. Be sure that the power indicator turns off; then, after more than 10 seconds, press the power button to turn it on again.*

After completing Windows setup:

- Confirm *Time Zone* is correctly selected and set the date and time by double-clicking the time appearing on the right of the taskbar to open *Date and Time Properties* dialog box
- Press **Fn+F1** () keys to activate the integrated antenna for Wireless LAN communication.





Properties Dialog Box in Windows

In this manual, you will often see the expression “XXX Properties dialog box.” A dialog box is a window containing text boxes, check boxes, buttons, etc., with which you can send commands to Windows or other application programs. To open the properties dialog boxes, click *start - Control Panel*. The *Control Panel* has two types of views: Category view and Classic view. The Category view allows you to choose the category that may be related to what you want to do, then, choose the task by clicking it. The Classic view gives you the icons representing their components or features. Double-click one of the icons to open their dialog box or windows. Some of the dialog boxes you will use often are:

- Display
- Phone and Modem Options
- Mouse
- Power Options
- System



Clicking Switch to XXX View string appearing at the upper left of the Control Panel window allows you to toggle between the two views.



Turning Off Your Computer

When you've finished using your computer, turn it off with one of the following ways:

- From the *start* menu
 1. Click *start – Turn Off Computer*.
 2. In the *Turn off computer* dialog box, click *Turn Off*.
- With the power button

Before using this step, confirm that *Shut down* is selected in *When I press the power button on my computer* in *Advanced* tab of *Power Options Properties* dialog box.

Close the cover to keep the screen and keyboard clean and protected.



If you have not saved a file, a dialog box will appear asking whether you want to save it.



- *Do not turn off or reset your computer while the hard disk indicator or the indicator on the optional external floppy disk drive unit or the external CD-ROM drive unit is lit. Doing so may damage or even wipe out the data.*
 - *Before turning it back on, wait at least ten seconds after turning off your computer. Turning the power off and on in rapid succession can damage your computer's electrical circuitry.*
-

CHAPTER 2

Basic Operations

This chapter describes the basic operations of your computer.

2



Choosing Power Source

You can use your computer with one of the following power sources:

- AC power from a wall outlet
Use AC power whenever possible; rely on the battery only when AC power is not available.
- Rechargeable battery
Your computer is equipped with a standard battery pack. You can also use an optional high capacity battery. See Chapter 3 for the battery information.

About Power Indicators

The following indicators show the power status of your computer.

Indicator	Light	Meaning	
Power 	On (green)	Operating	
	Blinking (green)	In System Standby	
	Off	Powered off or in System Hibernate	
Battery 	Connected to AC Power Source	On (green)	Fully charged
		On (orange)	Being charged
		Blinking (orange)	In abnormal state (Remove the battery pack and install it again.)
	Powered by Battery	Off	Has power
Blinking (red)		Almost completely discharged (The warning beep sounds.)	

The battery indicator is always off when your computer is turned off and not connected to AC power source.

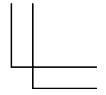

- *When the battery is hot, the battery indicator may turn off and stay off until the battery becomes cool.*
- *For more information on System standby/hibernate, see Chapter 3.*

Using AC Adapter

When connected to a wall outlet, the AC adapter provides power for operation and charges the battery. The AC input voltage can range from 100 to 240 volts so that you can use your computer with the appropriate plug adapter.

2



The AC power cord included with your computer is appropriate for the voltage used in the area in which you purchased your computer. If you attempt to connect your computer to a wall outlet other than in this area, check the voltage of the outlet and use an AC power cord appropriate for the outlet. Consult local service staff if you are not sure.

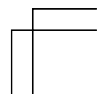
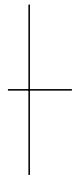
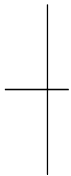

Resetting System

You may need to restart the system if your computer hangs up or a new hardware or software is installed. When a message appears after the installation, click *OK*, *Yes*, etc. to restart Windows.

You can also restart Windows by clicking *start - Turn Off Computer*; then, *Restart*.



Resetting may cause data loss. Use the resetting process only if the normal Windows Shut Down does not work because of software malfunction. Although resetting will not damage the system, you may lose the data you are processing.

2

Warm Boot (Software Reset)

If the system is locked up because of a software problem, you can reset or reboot the system by pressing the **Ctrl+Alt+Del** keys simultaneously and select *Applications* tab of *Windows Task Manager* dialog box. Click the program name which hangs up, then, *End Task*. If this does not solve the problem, click *Disconnect* or *Logoff* of *Windows Task Manager* dialog box, then *Yes*.

Power Switch

You can turn off your computer with the power button if you encounter hardware or software problems which lock up the system. In this case, press the power button for more than four seconds.

Reset Switch

If you cannot turn off your computer by pressing the power button, you can use the reset switch on the bottom of your computer. To reset the system, insert a narrow object into the small hole to press the switch.

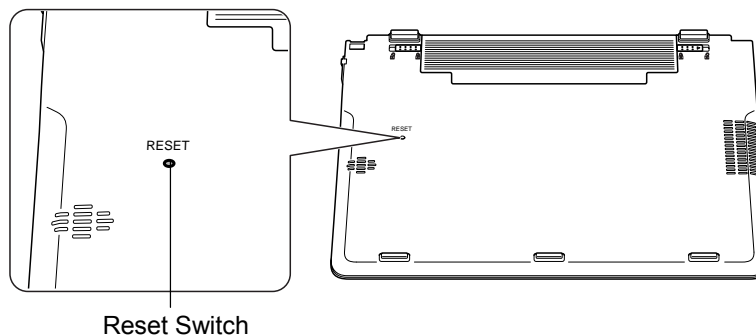

Reset Switch

Using Glide Pad

Your computer is equipped with an integrated pointing device called glide pad. Using the glide pad, you can move the pointer, select an item from a menu, and perform other tasks in the same way you would with a mouse.

2

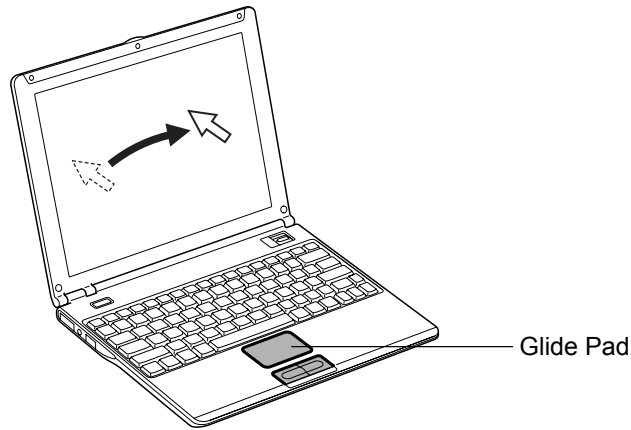

- Do not hit or scratch the surface of the glide pad with pointed objects (such as a ballpoint pen).
- Do not operate the glide pad with a moist finger. This may cause the glide pad to operate incorrectly.

Enabling Glide Pad

When a USB mouse is connected to one of the USB ports of your computer, the glide pad is disabled, which means that your computer does not respond to any tapping on the pad. Therefore, conflict with the mouse and/or unexpected move of the pointer on the screen can be avoided.

To enable the glide pad, use one of the following ways.

- Disconnect the connected USB mouse. (No mouse must be connected.)
- With a USB mouse connected, open *Mouse Properties* dialog box, click *Device Settings* tab, then, *Enable* button. (This operation allows your computer to always respond to the glide pad, while the connected USB mouse also works.)



When the glide pad is disabled, the Touch Pad icon (🖱️) on the taskbar is crossed (🖱️).



Using Glide Pad

Take a moment to become familiar with how the glide pad works.

Place Your Fingertip

Place your left or right hand next to the glide pad, resting your wrist naturally in a relaxed manner. Place your thumb or finger on the glide pad.

Move Your Fingertip

The rectangular pad of the glide pad is used to move the pointer around the display. As you slide your fingertip across the pad, the pointer on the screen moves in the same direction across the screen. The glide pad is very sensitive, so you do not have to exert much pressure on the pad. The glide pad will respond to a light touch from your fingertip.



2

Click, Double-click, and Right-click

To click or double-click, you can use the left button just like that of a mouse. Instead of clicking the left button, you can also just tap gently anywhere on the rectangular pad. For right-clicking, you must use the right button.



If the interval between clicks is too long, the double-click will not function.



Drag and Drop

You can move the items by using “drag and drop” below:

1. Position the pointer over the item you wish to move.
2. Press the left button; do not release it.
3. Move the pointer while holding the left button. The item moves together with the pointer.
4. Release the button when the item reaches its destination.

Or you can tap the pad twice and hold it instead of pressing the left button in the step 2.

Scroll

You can scroll through information in a list or in a document by using the glide pad. To view information vertically, place your finger on the most right part of the glide pad and slide your finger up and down. To view horizontally, place your finger on the bottom part of the glide pad and slide your finger to the left or the right. This procedure works only in limited applications.

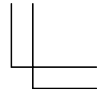

Changing Configuration

In the *Mouse Properties* dialog box, you can change the configuration of the glide pad, such as swapping left and right buttons, changing the pointer size, etc. Double-click  icon on the taskbar.

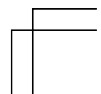
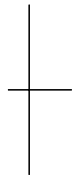
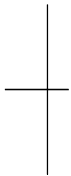

Using Keyboard

Your computer, equipped with the Windows Enhanced Keyboard, provides all the functionality of a full-sized desktop keyboard.

Special Keys

Windows Key () Opens the Windows start menu. This key functions the same as the *start* button on the screen.

Application Key () Opens short-cut menus for the specific items. This key functions the same as the right mouse button.

System Function Keys

Your keyboard contains the function keys labeled **F1** through **F12** for special actions. Use them in conjunction with **Fn** key.

Fn + F1 () Turns the wireless LAN antenna on and off.

Fn + F3 () Decreases the audio volume.

Fn + F4 () Increases the audio volume.

Fn + F5 () Rotates display mode between LCD only, an external monitor only, and both (when connecting an external monitor).

Fn + F6 () Decreases the LCD screen brightness.

Fn + F7 () Increases the LCD screen brightness.

Fn + F11 () Turns the LCD screen on and off.



Fn + F12 () Forces your computer into System standby, hibernate, or powered off. See *Power Management* of Chapter 3 for more information.

Controlling Volume

You can adjust the output volume of your computer with the following volume controls which interact with each other.

With Keyboard

2

To decrease the output volume, press and hold **Fn** key and then, press **F3** () key. To increase the output volume, press and hold **Fn** key and then, press **F4** () key.



These functions can work on Windows.

On Windows

1. Click *start - Control Panel*.
2. Click *Sounds, Speech, and Audio Devices*; then, *Sounds and Audio Devices*. If Classic view is selected, double-click *Sounds and Audio Devices* icon.
3. In *Sounds and Audio Devices Properties* dialog box, slide the lever to control the output volume.
4. Click *OK* and close the dialog box; then the *Control Panel* window.



You can also easily adjust the volume in the window that will open when clicking the speaker symbol on the taskbar. When the symbol is not on the taskbar, check the box of Place volume icon in the taskbar in the step 3.

If you want to adjust the output volume of each source individually:

1. Click *start - Control Panel*.
2. Click *Sounds, Speech, and Audio Devices*; then, *Sounds and Audio Devices*. If Classic view is selected, double-click *Sounds and Audio Devices* icon.
3. In *Sounds and Audio Devices Properties* dialog box, click *Advanced...* button of *Device volume* section.
4. Slide the lever of the source that you want to control.
5. Close the dialog box, then; click *OK* and close the *Control Panel* window.



If you control:

- Wave** → Controlling the volume of CD or WAVE file
- SW Synth** → Controlling the volume of MIDI file



Any software containing audio function may also have its own volume control. Note that the volume controls discussed on the previous page and the software volume control will interact with each other.

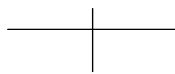
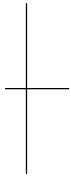
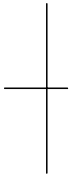

Adjusting Display

You can adjust the brightness, resolution, and number of colors of the internal LCD display for more comfortable viewing.

Changing Brightness of Display

To decrease the brightness of the internal LCD display, press and hold the **Fn** key, and then press the **F6** () key.

To increase the brightness of the internal LCD display, press and hold the **Fn**, and then press the **F7** () key.

Changing Resolution and Number of Colors

When shipped, your computer is set to the default resolution and color. The default resolution is 1024 x 768 at 64K colors. To change the resolution and the number of colors, follow the instructions below:

1. In the *Display Properties* dialog box, select *Settings* tab.
2. Select the number of the colors in the *Color quality*, and select the resolution in the *Screen resolution*. Refer to the table below.
3. Click *OK*; then, *Yes*.

Available Resolutions and Colors

Resolution	Number of Colors
800 x 600	64K 16M ^{(*)2}
1024 x 768	64K 16M ^{(*)2}
1280 x 768	64K 16M
1280 x 1024 ^{(*)1}	64K 16M ^{(*)2}
1600 x 1200	64K
2048 x 1536	64K

^{(*)1}) Only 1024 x 768 dots appear even on the internal LCD screen of 1280 x 768 or higher resolution. To see the hidden parts, move the mouse pointer to the parts and scroll it. When the resolution is set to 1024 x 768 or higher, the number of colors may be automatically set to 64K.

^{(*)2}) On the internal LCD screen, the number of colors in this mode is made using a Dithering algorithm.



- You cannot switch to display resolutions and number of colors that are not available.
- In the Color quality, Medium (16 bit) means 65,536 (64K) colors, and Highest (32 bit) means about 16,770,000 (16M) colors.

Displaying on Screen Upside Down

This feature allows you to show the images on the LCD screen upside down. Use this feature when showing the images on your computer to someone on your opposite side.

To display the image upside down, press **Ctrl+Shift+F4** ().

To display the image in its original position, press **Ctrl+Shift+F3** ().



- When displaying images upside down, you see the pointer on the screen move in the opposite direction. Moving your finger or the mouse to the right on the glide pad, for example, will make the mouse pointer move to the left.
- When displaying images upside down, drawing speed may be delayed.
- Do not display upside down when playing animation..

2

Changing Wallpaper and Setting Screen Saver

You can enjoy various desktop patterns or screen savers.

Changing Wallpaper

1. In the *Display Properties* dialog box, select *Desktop* tab.
2. Select appropriate wallpaper in *Background*.
3. Click *OK*.

Setting Screen Saver

1. In the *Display Properties* dialog box, select *Screen Saver* tab.
2. Select an appropriate screen saver in *Screen saver* and set time when screen saver starts.
3. Click *OK*.



To disable the screen saver, select [None] from the Screen saver pull-down menu.



Sharing Your Computer

If you are sharing your computer with your colleagues or family members, set a user account for each person. Every user can choose their favorite desktop setting, web site lists, or make their own *My Documents* folder etc., and save them to their user accounts. When you turn on your computer, select your user account.

2

Setting New User Account

1. Click *start - Control Panel*.
2. Click *User Accounts*. If Classic view is selected, double-click *User Accounts* icon.
3. Click *Create a new account* string.
4. Type a name for the new account and click *Next*.
5. Select the account type; then, click *Create Account*. If you have selected a *Limited* account, then that user account has limits for using your computer. See *Help and Support Center* in *start* menu for more details.
6. Close *User Accounts* dialog box; then, the *Control Panel*.

If more than one user accounts are set to your computer, you must select which user account you will log in when you turn on your computer.

Log Off Your Computer

“Log off” is useful because you do not have to turn off your computer when you finish your task and pass your computer to another person. There are two ways to log off your computer, *Switch User* or *Log Off*.

If you select *Switch User*, you can pass your computer to another person without closing your current applications. For example, if you are viewing a Web site, and your colleague needs to open a program on your computer, use *Switch User*. You can then view the same Web site by just switching users after your colleague finishes with your computer.

If you select *Log Off*, the system will close all your session and you need to save your files before logging off your computer.

1. Click *start - Log Off*.
2. Select *Switch User* or *Log Off*. If you select *Log Off*, the dialog box, which asks you to save your data may appear.



3. Select a new account to start Windows XP again.



If you cannot see Switch User in Log Off Windows dialog box, click Change the way users log on or off string in User Accounts dialog box, and check Use Fast User Switching and click Apply Options.

Setting Password to User Account

You can set a password to each user account to avoid unauthorized use of your computer. Once you set the password, you need to enter it when you log on to its account. You cannot start your computer with the user account if its password is not correct, so unnecessary password setting can cause trouble in starting the system.

2

Setting Password

1. Click *start - Control Panel*.
2. Click *User Accounts*. If Classic view is selected, double-click *User Accounts* icon.
3. Select the account you want to set a password to. You will only have this option if you log onto the computer as a member of the Computer administrators group. If you log on your computer with a limited user account, go to the next step. (You cannot set a password to another user account.)
4. Select *Create a password* string.



- *If the password has been already set, Create a password will not appear.*
- *Only the members of the Computer administrators group can set a password to another user account.*

5. Type a new password.
6. Type the new password again to confirm it.
7. If necessary, type a password hints word to remember the password you set.
8. Click *Create Password*.
9. Close the *User Accounts* dialog box; then, the *Control Panel* window.

Changing Password

1. Follow the steps 1-2 on the previous section.
2. Select the account you want to change, if you log on to your computer as a member of the Computer administrators group. If you log on your computer with



a limited account, go to the next step. (You cannot change the password of another user account.)

3. Select *Change the password* string or *Change my password* string.



- *If the password has not been set yet, Change the password or Change my password will not appear.*
- *Only the members of the Computer administrators group can change the password of another user account.*

2

4. Type the current password. If you are changing another user's password, skip this step.
5. Type a new password.
6. Type the new password again to confirm it.
7. If necessary, type a password hints word to remember the password you set.
8. Click *Change Password*.
9. Close the *User Accounts* dialog box; then, the *Control Panel* window.

Deleting Password

1. Follow the steps 1-2 on *Setting Password*.
2. Select the account you want to delete its password, if you log on to your computer as a member of the Computer administrators group. If you log on your computer with a limited account, go to the next step. (You cannot delete the password of another user account.)
3. Select *Remove the password* string or *Remove my password* string.



- *If the password has not been set yet, Remove the password or Remove my password will not appear.*
- *Only the members of the Computer administrators group can delete the password of another user account.*

4. Type your password and click *Remove Password*. If you log on to your computer as a member of the Computer administrators group and want to delete the password of another user account, just click *Remove Password*.
5. Close the *User Accounts* dialog box; then, the *Control Panel* window.



CHAPTER 3

Battery and Power Management

This chapter explains how to manage your computer's power effectively and use the battery pack.



In this section, you often see the expression "Power Options Properties dialog box". To open the dialog box:

1. Click start - Control Panel.
2. Click Performance and Maintenance - Power Options in Category view or double-click Power Options icon in Classic view.

3

Battery Pack

When not connected to an external power source, your computer operates with the rechargeable battery pack. The duration of the battery life may be longer if your computer's power management is active. See the next section for power management.

To keep the battery life longer:

- Condition the battery pack if the actual remaining power in your battery is less than what Windows *Power Meter* indicates. (See *Conditioning Battery Pack* section in this chapter.)
- Turn off your computer when you are not using it.



- *The duration of the battery depends on your computer usage. Using applications, which heavily use external peripherals, will result in shorter battery life.*
- *When using your computer for several hours with battery power, enable power management and set System hibernate. Refer to the Power Management section in this chapter.*
- *When the battery has not been charged, your computer may not operate properly. Connect the AC power source to charge the battery.*

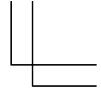
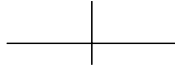

Charging Battery Pack

1. Connect the AC adapter to your computer. While the battery is being charged, the battery indicator lights orange.
2. When the battery is fully charged, the battery indicator turns green. Charging time may vary according to the status of your computer.



- *The battery indicator may turn off even while the battery is being charged. This is because the battery pack is hot, and the charging stops temporarily. When the battery becomes cool, the charging will start and the battery indicator will turn on again.*
- *The battery pack may not be installed correctly if the battery indicator blinks orange. In this case, turn off your computer, remove the AC adapter and the battery pack; then, install the battery pack and connect the AC adapter again. If the battery indicator still blinks orange, ask your local dealer for assistance.*
- *When the battery pack is hot (for example, after a long use), it may take longer to be fully charged.*

3

Charging Battery Pack Using Connection Cradle

You can also charge the battery pack using the connection cradle. Insert the battery pack in your computer, set your computer in the connection cradle and connect it to the AC power. For details on connection cradle, see Chapter 7.

Checking Battery Level

On Windows

You can check the battery level by placing the pointer on the battery icon (🔋: powered on battery) or AC plug icon (🔌: powered on AC power and charging the battery pack) on the taskbar, or double-clicking one of these icons (🔋, 🔌 or 🖱️: powered on AC power) to open the *Power Meter* dialog box. If the battery is fully charged, remaining capacity level will not appear even if you point to the icon.

If you cannot see the battery or AC plug icon, follow these instructions:

1. In the *Power Options Properties* dialog box, select *Advanced* tab.
2. Check the box of *Always show icon on the taskbar* and click *OK*.
3. Close the *Control Panel* window.

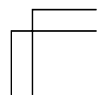



- *The remaining operating time depends on the amount of the power you are consuming. If you are using the audio system, PC card slot, hard disk drive, or peripheral devices with your computer, it may consume more battery power.*
- *If the actual remaining power in your battery is less than what Power Meter indicates, you should condition the battery pack as per the procedure on Conditioning Battery Pack section in this chapter.*

With Battery Level Lamp

You can also check the battery level by the battery lamp on the battery pack. Remove the battery pack from your computer and push the battery level button on the battery pack.

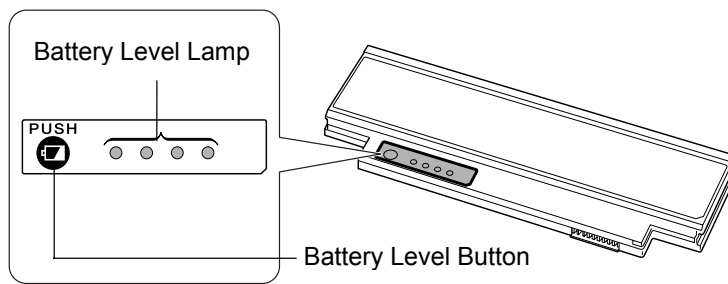

3

Low Battery Indication

When the battery power level becomes significantly low, the battery indicator () blinks red, the warning beep sounds. Save your data and turn off your computer, or connect the AC power source immediately. Otherwise, your computer will be shut down and the unsaved data may be lost.

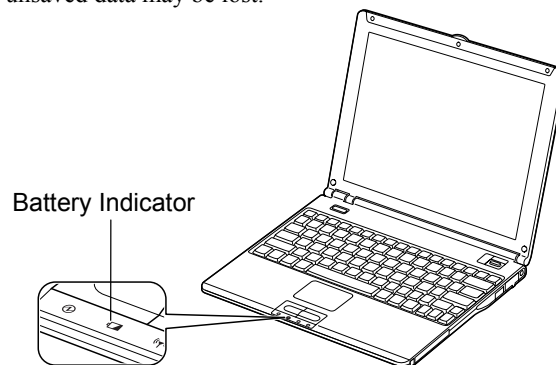

On Windows, you can set the battery level for sounding an alarm and letting your computer go on System standby, System hibernate or shut down afterward.

1. In the *Power Options* Properties dialog box, select *Alarms* tab.
2. Set the battery level at which the alarms are activated. We recommend you set *Critical battery alarm* to 5 % or more and *Low battery alarm* to more than the value of *Critical battery alarm*.
3. Set the *Alarm Action...* to the appropriate settings.
4. Click *OK* twice.
5. Close the *Control Panel* window.

3 Conditioning Battery Pack

When the actual remaining power in your battery is less than what Windows Power Meter indicates, you need to condition the battery pack or buy an optional high capacity battery pack.

1. Make sure your computer is turned off. Connect the computer to AC power source and wait until the battery is fully charged. The battery indicator turns orange first, then, turns green when the battery pack is fully charged.
2. Turn on your computer.
3. When the message *Press <F2> for System Utilities* appears, press **F2** to open the Setup Utility.
4. Disconnect the AC adapter.
5. Set the mobile mode switch to the **NORMAL** position.

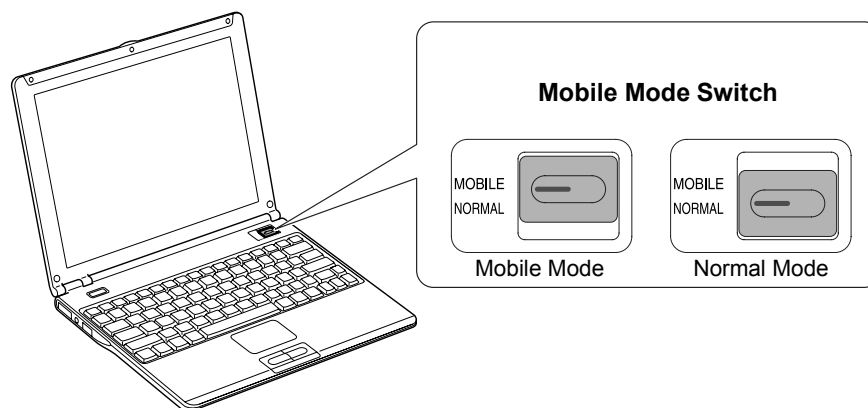

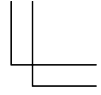
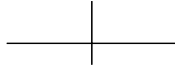

6. With the **Fn** key pressed down, press the **F7** key several times so that the screen brightness is maximized.
7. Leave your computer on to discharge the battery pack. When it is completely discharged, the system will automatically shut down.
8. Connect your computer to AC power source and let the battery fully charged again.



- *Do not turn on your computer while charging the battery pack.*
- *Do not connect your computer to a wall outlet while discharging the battery. The conditioning will be cancelled.*



Repeated charging and discharging or long-term storage of the battery pack cause battery deterioration. In this case, replace the battery pack with a high capacity battery pack.

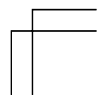
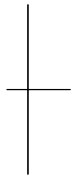
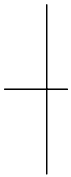

Changing Battery Pack to Optional High Capacity Battery Pack

The capacity of a battery pack gradually decreases when used repeatedly (the deterioration rate depends on the operating environment). If the battery life becomes extremely short even after the conditioning, you should buy an optional high capacity battery pack (CE-BL25).

When you replace the battery pack with the optional one:

1. Turn off your computer and disconnect the AC adapter from your computer.
2. Close the display cover and turn over your computer on a flat place.
3. Slide the battery stopper to the unlocked position (a).

3

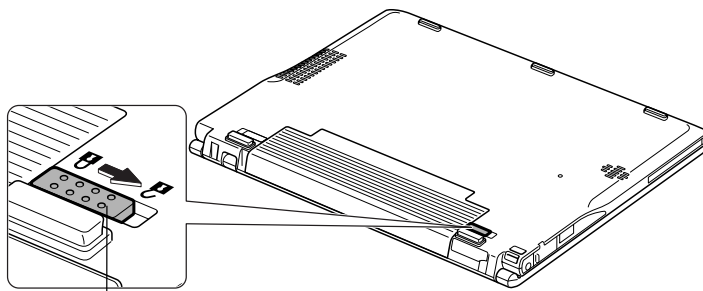

Battery Stopper

4. Slide the battery release lever to the unlocked position (a) and hold it (1); then, pull out the battery pack (2).

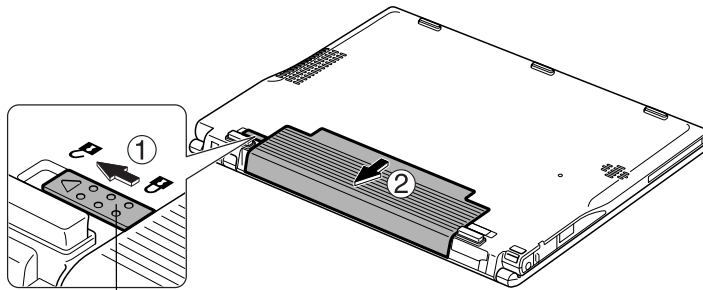

Battery Release Lever

5. Insert the high capacity battery pack into the computer by matching the notched parts of the battery to the projected parts of the computer.

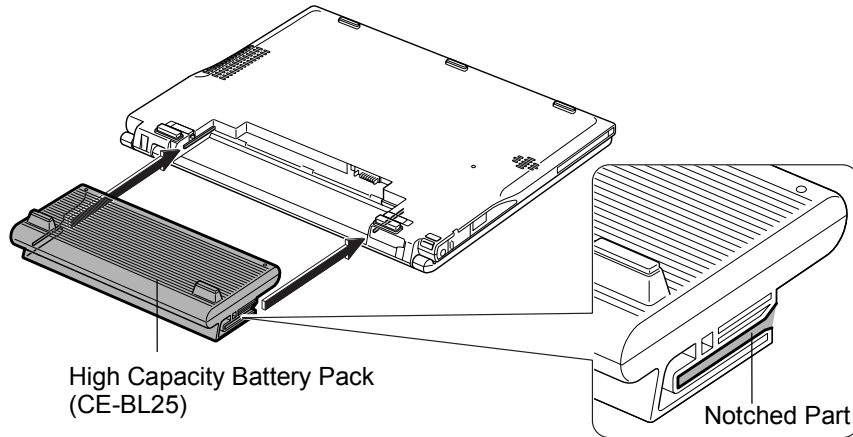

3

Checking Battery Level of High Capacity Battery Pack

Follow the steps in *Checking Battery Level* in this chapter.

Conditioning High Capacity Battery Pack

Follow the steps in *Conditioning Battery Pack* in this chapter.

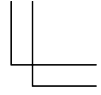
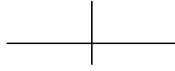

Power Management

Power management saves electricity and extends battery life by controlling power supply to built-in devices. You can set the following power management properties on Windows.

- Stopping power supply to the hard disk
- Stopping power supply to the display
- Using System standby/hibernate
- Using mobile mode switch

3

To open *Power Options Properties* dialog box, click *start – Control Panel*, and click *Performance and Maintenance*; then, *Power Options*. If Classic view is selected, double-click *Power Options* icon.



Note that the power management may not seem to function when you are using an application program that accesses the hard disk periodically.

Stopping Power Supply to Hard Disk

1. In the *Power Options Properties* dialog box, select *Power Schemes* tab.
2. Set *Turn off hard disks* to an appropriate value, and click *OK*.
3. Close the *Control Panel* window.

Stopping Power Supply to the Display



This procedure is also effective for an attached external monitor complying with power management.

1. In the *Power Options Properties* dialog box, select *Power Schemes* tab.
2. Set *Turn off monitor* to an appropriate value, and click *OK*.
3. Close the *Control Panel* window.

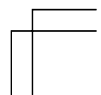

Using System Standby/Hibernate

System standby/hibernate is a very useful power management tool. For example, after your computer has entered *System standby* mode, you can restart your computer more quickly when compared to a restart, after a normal shutdown operation. When your computer resumes from *System standby/hibernate*, the system restores the exact last state of your computer. In Windows, you can define *System standby* or *System hibernate* the system enters under what conditions.

- *System standby* stores the current condition of your computer in RAM and stops power supply to all but a few essential components. Your system enters and resumes from *System standby* per the conditions mentioned later. In *System standby*, the power indicator blinks green. To resume from *System standby*, press any key.
- *System hibernate* saves the current condition of your computer in part of the hard disk and turns off your computer. Your system enters and resumes from *System hibernate* per the conditions mentioned later. In *System hibernate*, the power indicator is off. To resume from *System hibernate*, press the power button.

3



When entering/resuming from System standby/hibernate, follow these instructions:

- *Finish communications, printing, and playing music or video before entering System standby/hibernate.*
 - *Do not operate your computer or peripheral devices, or connect/disconnect peripheral devices, while entering/resuming from System standby/hibernate.*
 - *Save your data before your computer enters System standby. If the power supply to your computer is stopped, the RAM contents will be lost.*
 - *Select your user account if Windows requires when your computer resumes from System standby/hibernate.*
-

Supporting System Hibernate



If your battery becomes completely discharged during System standby, you will lose unsaved data and will need to reboot your computer. Therefore, if you are planning to leave your computer powered by battery for long periods of time, we recommend System hibernate.

Confirm that *System hibernate* is supported with the following steps.

1. In the *Power Options Properties* dialog box, select *Hibernate* tab.
2. Confirm *Enable hibernation* is checked.
3. Click *OK*.
4. Close the *Control Panel* window.

3

Set Timer to Enter System Standby/Hibernate Automatically

Your computer will enter System standby/hibernate automatically when the specified time has passed without any operation. To set the time:

1. In the *Power Options Properties* dialog box, select *Power Schemes* tab.
2. From the pull-down menu of *System standby* or/and *System hibernates*, select the elapsed time before your computer automatically enter System standby/hibernate.
3. Click *OK*.
4. Close the *Control Panel* window.

Entering System Standby/Hibernate

Your computer enters *System standby/hibernate* in each of the following cases:

- You select *Stand By* or *Hibernate* (which will replace *Stand By* if you press **Shift** key) in the *Turn off computer* dialog box. To open the dialog box, click *start – Turn Off Computer*.
- The specified time in *System standby* or *System hibernates* in *Power Schemes* tab of *Power Options Properties* dialog box has passed without any operation (See the previous section).
- The screen cover is closed.

The above functions if you perform the following:

1. In the *Power Options Properties* dialog box, select *Advanced* tab.
2. Select *Hibernate* or *Stand by* in *When I close the lid of my portable computer* field.
3. Click *OK*.
4. Close the *Control Panel* window.

- You press the power button.

The above functions if you perform the following:



1. In the *Power Options Properties* dialog box, select *Advanced* tab.
2. Select *Hibernate* or *Stand by* in *When I press the power button on my computer* field.
3. Click *OK*.
4. Close the *Control Panel* window.

- You press **Fn+F12** (.

The above functions if you perform the following:

1. In the *Power Options Properties* dialog box, select *Advanced* tab.
2. Select *Hibernate* or *Stand by* in *When I press the sleep button on my computer* field.
3. Click *OK*.
4. Close the *Control Panel* window.



*If Ask me what to do is selected in the step 2 of You press the power button or You press **Fn+F12** () , the Turn off computer dialog box will appear when you press the power button or **Fn+F12** () key combination. You can select System standby or System hibernate at that timing.*

- The battery level is low.

The above functions if you set the alarm in Windows. See *Low Battery Indication* in this chapter.

Disabling Power Management

1. In the *Power Options Properties* dialog box, select *Power Schemes* tab.
2. Set *Turn off monitor*, *Turn off hard disks*, *System standby*, and *System hibernates* to *Never*; then, click *OK*.
3. Close the *Control Panel* window.



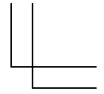
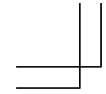

Using Mobile Mode Switch

Your computer is equipped with the mobile mode switch allowing you to extend battery life. When your computer is in mobile mode, it automatically controls system power consumption: by reducing CPU performance and decreasing screen brightness. The control will make the battery life longer.

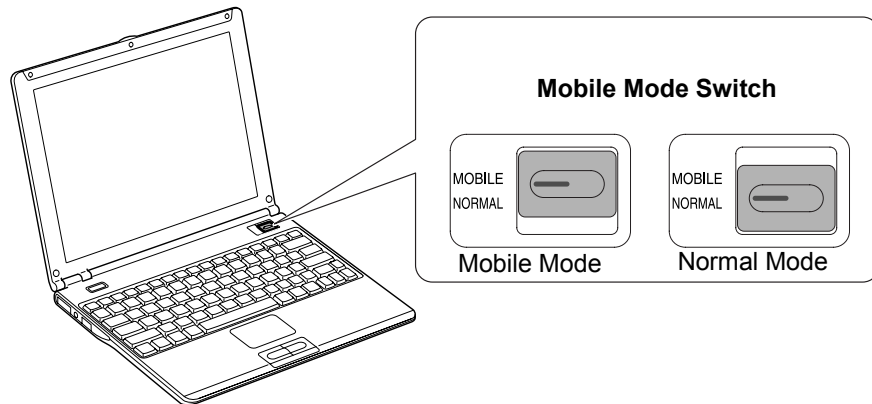

Mobile Mode

Use your computer in mobile mode to obtain longer battery life when needed. The mobile mode provides the second lowest screen brightness.

Normal Mode

Use your computer in normal mode when you do not need to power down CPU performance even on battery operation.



- *The mobile switch does not work when your computer is powered by the AC power source.*
- *The screen brightness can be increased by pressing the **F7** key while holding down the **Fn** key. Be sure that screen brightness and battery life are in inverse proportion to one another. The maximized screen brightness will cause shorter battery life.*
- *The screen brightness can be adjusted respectively in mobile mode and normal mode.*
- *Mobile mode may cause an animation to produce an irregular motion or frame dropouts since the CPU performance is reduced.*

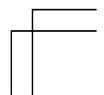

CHAPTER 4

Peripherals

This chapter describes how to use peripheral devices with your computer. You can connect a floppy disk drive unit, an optional CD-ROM drive unit, a printer, an external monitor, an, PC cards, or other devices to your computer. To ensure proper use, be sure to read the instructions for each peripheral device before connecting it to your computer.

4

Peripheral Device Connectors

Your computer has connectors for peripheral devices, shown on the next page. For connection, refer to the section explaining each device, or contact your dealer.



- *Be sure to turn off your computer and the peripheral devices before connecting them (except when connecting/inserting USB devices, an IEEE1394 device, a PC card, etc.).*
- *Confirm the peripheral device you will connect is Windows XP compatible.*
- *When you connect some of the devices, you may have to turn on your computer before powering on the devices.*
- *Some devices require that you install their drivers before use.*

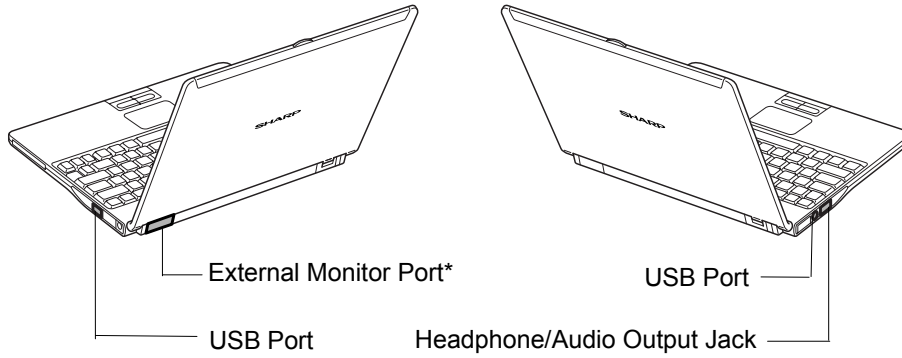

Peripheral Connection Overview



4

*Use the provided display converter cable to connect an external monitor to your computer.

Connector Shape

Connector name	Connector shape
USB Port	
External Monitor Port	
Headphone/ Audio Output Jack	

Optional External Floppy Disk Drive Unit

You can use double-density (2DD) 720KB or high-density (2HD) 1.44MB floppy disks with the optional external floppy disk drive unit (CE-FD05).

Connecting Optional External Floppy Disk Drive Unit



- Do not place the floppy disk drive unit on its side or upside down.
- Do not press on the floppy disk drive unit. It may damage the drive or cause malfunction.
- Do not place the AC adapter on the floppy disk drive unit. It may cause the drive to malfunction.

Connect the floppy disk drive unit cable to either of the USB ports on your computer. Be sure to let the USB mark side up when connecting the cable to your computer.

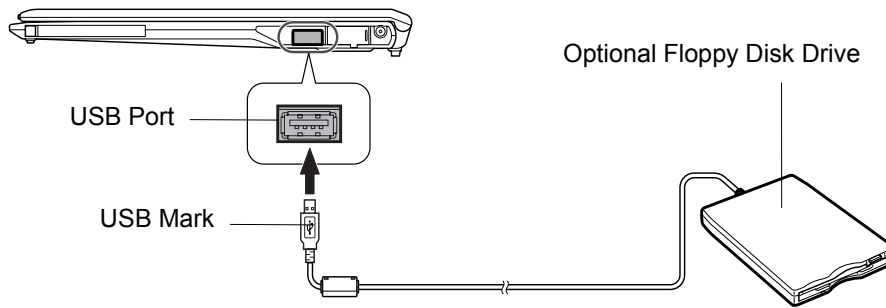

Handling Floppy Disk

- Do not open the shutter and touch the disk inside; otherwise, you will not be able to read or write data to the disk.
- Do not place floppy disks near magnets or heat source, in direct sunlight or in a dusty place, etc.
- Never subject a disk to sudden shocks or extreme vibration. Do not drop, bend, or place heavy objects on a disk.
- Do not spill liquid onto a disk.

Inserting Floppy Disk

Hold the floppy disk with the arrow facing up, toward the drive. Slide the disk into the drive until it locks into place.

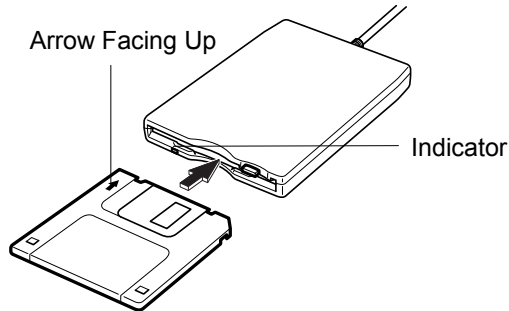

4



- *Always insert a floppy disk straight into the floppy disk drive.*
- *When inserting the disk, make sure it is not upside down.*
- *Do not use excessive force when inserting the floppy disk. If you have difficulty inserting or removing disks, seek the assistance of an authorized service technician.*
- *Do not touch the disk while reading/writing data. It may cause malfunction of your computer and the drive.*

Ejecting Floppy Disk



Before ejecting the floppy disk, make sure the indicator of the floppy disk drive unit is not lit.

Press the eject button firmly. The disk pops out slightly. Eject it and store it properly.

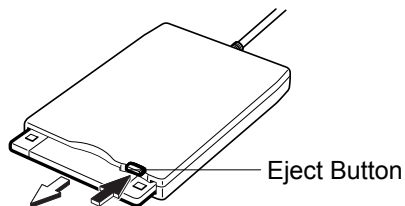

Formatting Floppy Disk

1. Make sure the floppy disk is not write-protected, and insert it into the floppy disk drive.
2. Click *start - My Computer*.
3. Right-click *3 1/2 Floppy (A:)* icon; then, click *Format...* from the pop-up menu.
4. Select the appropriate formatting options.
5. Click *Start* to start formatting.



- *When you format a floppy disk that already contains data, all of the data stored on the disk will be lost.*
 - *You cannot format a double-density (2DD) 720KB floppy disk.*
-

Removing Optional External Floppy Disk Drive Unit

To remove the unit, you need to perform the following steps before you remove it:

1. Click *Safely Remove Hardware* icon () on the taskbar.
2. Click *Safely remove Mitsumi USB Floppy – Drive(A:)*; then, *Safe To Remove Hardware* dialog appears.
3. Remove the unit from your computer.

Optional External CD-ROM Drive Unit

A compact disc (CD) is a storage medium, with which you can read data, play music, install and run programs, etc. The optional external CD-ROM drive unit (CE-CD05) can be connected to either of the USB ports on your computer.



CAUTION FOR LASER

Use of controls or adjustments or performance of procedures other than those specified herein may result in hazardous radiation exposure. Maximum output and wavelength of the laser: 903 μ W, 785nm

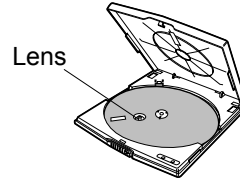
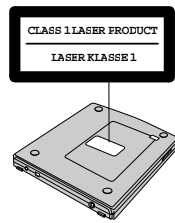

4

Precautions

- Do not disassemble the CD-ROM drive unit and do not repair it by yourself. Doing so may cause electrical shock hazard, or a laser may damage your eyes.
- Do not store or use the CD-ROM drive unit in a dusty, humid, oily environment, or under damp or moist conditions.
- Do not turn up the volume too high, when using the headphones.
- Do not leave the CD-ROM drive unit in direct sunlight, near a heat source or especially in a hot automobile.
- Do not drop or jar the CD-ROM drive unit.
- Do not touch the pins/terminals of the USB cable.
- When the CD-ROM drive unit has been moved from a cold place to warm place, it may damp or moist. Leave it for about 1 hour before using.
- Keep magnetic objects away from the CD-ROM drive unit.
- Do not insert any foreign metal object inside the CD-ROM drive unit.
- Do not touch the lens.
- If noise is heard from radio or TV, move the CD-ROM drive unit 2 m (about 6 ft.) away from the radio or TV.

Connecting Optional External CD-ROM Drive Unit (CE-CD05)



- Do not place the CD-ROM drive unit on its side or upside down.
 - Do not press on the CD-ROM drive unit. It may damage the drive or cause malfunction.
 - Do not place the AC adapter on the CD-ROM drive unit. It may cause the drive to malfunction.
-

1. Connect the core side connector of the USB cable included in the optional external CD-ROM drive unit to the cable connector of the drive unit.

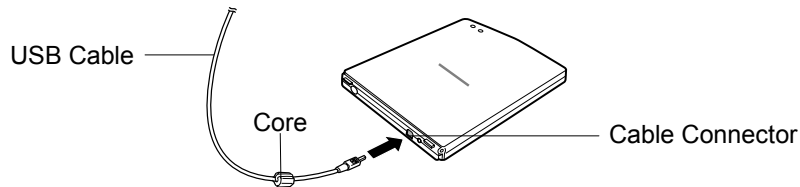

2. Insert the USB connector of the cable into one of the USB ports of your computer. The CD-ROM drive unit automatically turns on and the power indicator lights up.

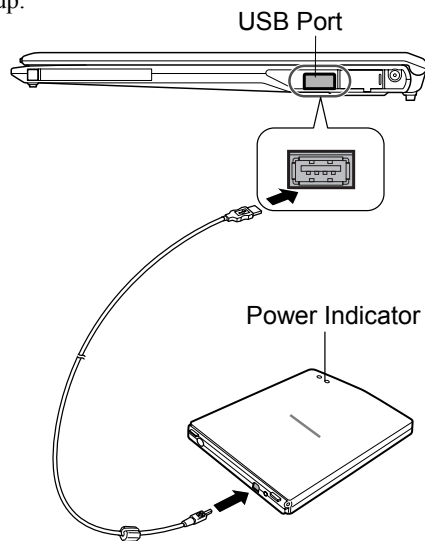

- Slide the cover latch to the right and open the cover.

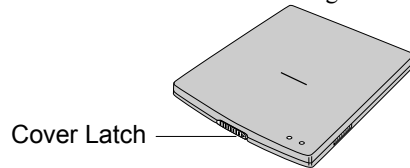

- Remove the protection sheet before you use the drive for the first time.

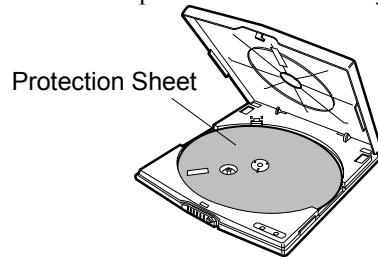

4

Handling CD

- Do not write on either side of the disk, particularly the non-label side. Data is read from the non-label side. Do not mark this surface.
- Keep your disks away from direct sunlight, heat and excessive moisture.
- Always hold the CDs by the edges. Fingerprints, dirt or water on the CDs cause noise or improper tracking. If a CD is dirty or does not play properly, clean it with a soft, dry cloth, wiping straight out from the center, along the radius.

Inserting CD

You can operate the external CD-ROM drive unit only when the computer is on.

- Make sure the busy indicator light is not on.

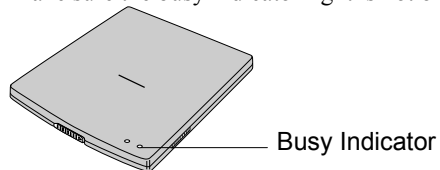

- Slide the cover latch to the right to open the cover and raise it.

3. Place your CD onto the disk spindle and press on the center of your CD with label side up, until it locks onto the disk spindle.

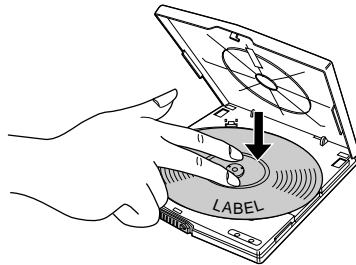

4. Close the disk cover.



- Insert a CD firmly until it is locked onto the spindle; then, close the disk cover, or the disk may fall off the spindle and get damaged.
- Do not leave the tray open. Also, avoid touching the lens in the tray. If the lens becomes dirty, the CD-ROM may malfunction.
- Do not wipe the lens with materials with rough surface (such as paper towels). Instead, use a cotton swab to gently wipe the lens.

4

Removing CD

1. Make sure the busy indicator is not lit.
2. Slide the cover latch to the right and open the cover.
3. Press down the disk spindle and remove the CD from the tray holding its edge.

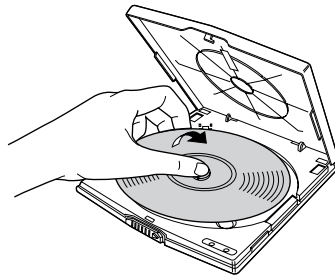

- Make sure the busy indicator is not lit or blinking before opening the disk cover.
- When opening the cover, if the CD is still spinning, wait until it has stopped, then remove it.



Playing CD

With some CD-ROMs, you can hear the sound of them through the audio out jack of the CD-ROM drive unit. Connect headphones or speaker system with an amplifier to the audio out jack.

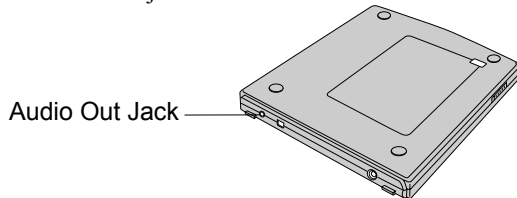

Disconnecting Optional External CD-ROM Drive Unit

To remove the unit, you need to perform the following steps before you remove it.

1. Click *Safely Remove Hardware* icon () on the taskbar.
2. Click *Safely remove USB Mass Storage Device*; then, *Safe To Remove Hardware* dialog appears.
3. Remove the USB cable from the computer.

4

Mode Switches

There are the mode switches on the bottom of the CD-ROM unit.

These switches are for technical services. Keep them as a default setting, *OFF*.

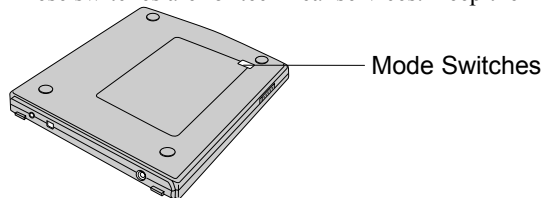

Cleaning Optional External CD-ROM Drive Unit

- Do not use solvents such as benzine, thinner, alcohol, record cleaner or anti-static spray.
- Clean the outside of the drive with a soft, dried cloth.
- Clean the lens with a commercial lens blower if the lens is dirty.



External Display

You can use an external monitor with your computer. To display the images on both displays simultaneously, use the 1024x768 resolution.



- *Some monitors, which are not compatible with your computer, may not display correctly.*
- *In this section, you often see the expression “Display Properties dialog box.” To open the dialog box, right-click somewhere on the Windows desktop and select Properties from the pop-up menu.*

Connecting External Monitor

Use the provided display converter cable to connect an external monitor with your computer.

1. Turn off your computer and the external monitor.
2. Connect the provided display converter cable with the display cable as shown below. If the display cable has screws, make sure to tighten them.

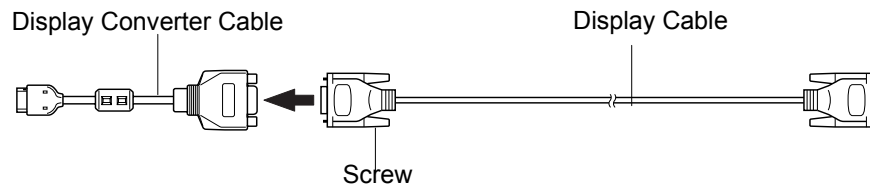

3. Connect one end of the display cable to the external monitor port, then, the other end of the display cable to your external monitor. If the display cable has screws, be sure to tighten them.

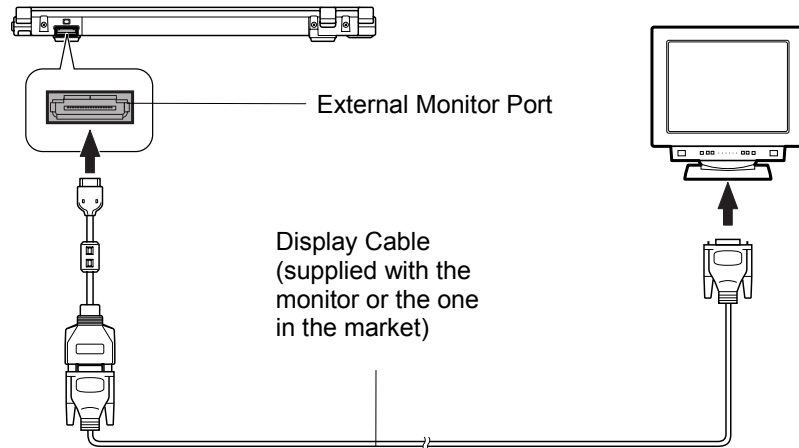

4. Turn on the external monitor; then, your computer.

Disconnecting External Monitor

1. Turn off your computer and the external monitor.
2. Press the button on the connector of the display converter cable, and hold it; then, remove it from your computer.

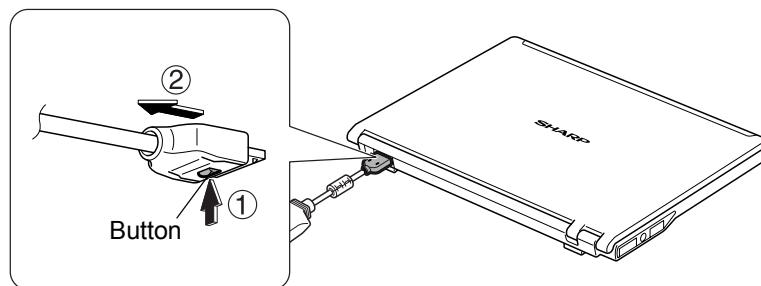

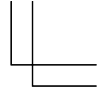
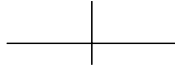

Switching Display

1. In the *Display Properties* dialog box, select *Settings* tab; then, click *Advanced* button.
2. Select *Display* tab; then, click the button before the output display you desire and click *OK*. *Monitor* means the internal LCD display and *Panel* means the external display.
3. Click *OK* in the *Confirmation* window.
4. Click *Yes* in the *Confirmation* window.
5. Close the *Control Panel* window.

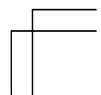
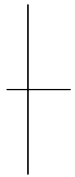
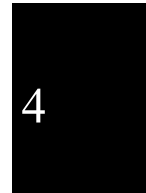
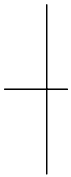

Displaying Image on LCD and External Monitor



When displaying on both of the LCD monitor and the external monitor simultaneously, the external monitor should be capable for displaying in 1024 × 768 resolution or higher. Otherwise, you may not display images on the external monitor properly.

You can display the same image on the LCD and the external monitor simultaneously when you connect the external monitor to your computer.



To extend the image on your LCD onto an external monitor:

1. In the *Display Properties* dialog box, select *Settings* tab.
2. Select “2” display icon, then, check the box of *Extend my Windows desktop onto this monitor* at the bottom of the dialog box.
3. Click *OK*, then, follow the instructions shown on the screen.



To stop extending the image onto the external monitor, uncheck the box of Extend my Windows desktop onto this monitor.



- You can also switch the display with **Fn+F5** () .
- When you log on your computer as a member of the Limited group, you cannot switch the display with the dialog box. Use **Fn+F5**() keys.
- When displaying in Resolution Expansion mode (see 6-4), you cannot switch the display using **Fn+F5** () keys.
- While playing video or animation, you may not be able to switch the display.

Audio System

You can output sound to speakers, audio equipment or headphones.

Connecting Speaker

You can connect stereo speakers with an amplifier to the audio output jack on the left side of your computer

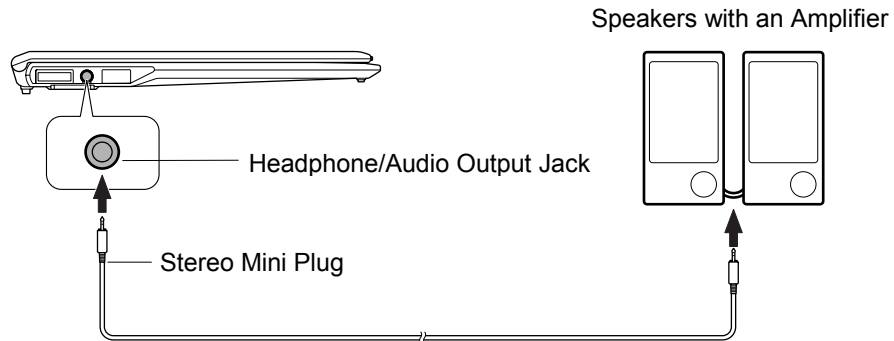

Connecting Audio Equipment

You can connect analog audio equipment to the audio output jack on the left side of your computer.

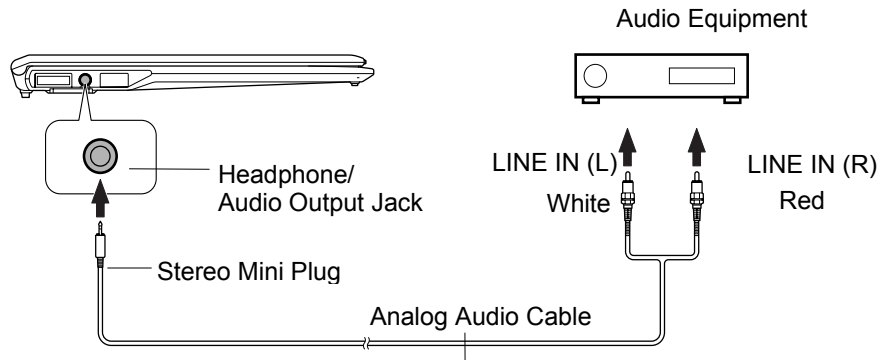

*You can adjust the output volume on Windows by clicking the speaker symbol on the taskbar or use **Fn + F3** (▼) or **F4** (▲) keys combination.*

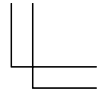

Connecting Headphone

Use the headphone with an impedance of 8Ω or more (32Ω is recommended.)

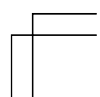
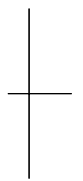
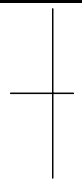
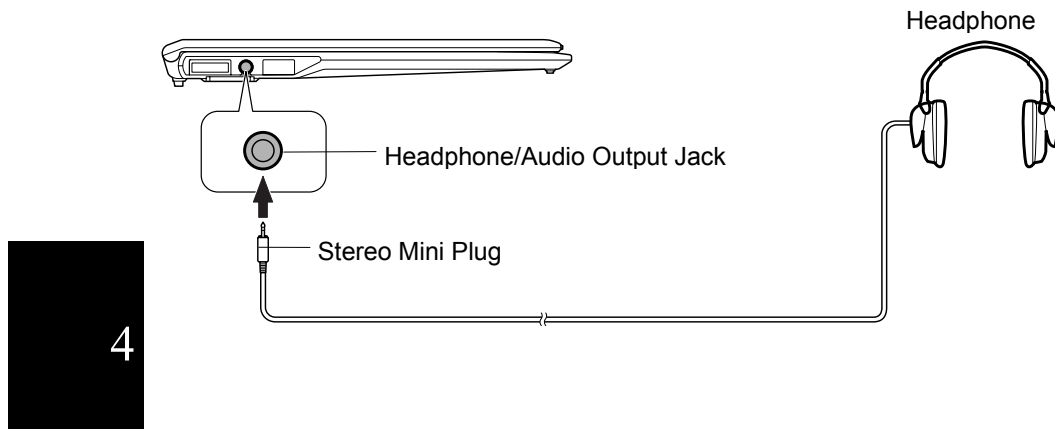

USB Device



Your computer has an interface called Universal Serial Bus (USB) and its two USB ports support USB1.1 and USB2.0. With a USB connection, you can connect/disconnect peripherals without turning off your computer. Generally, when you connect a device to your computer, the necessary driver will be installed automatically. See also the manuals of peripheral devices supporting USB.

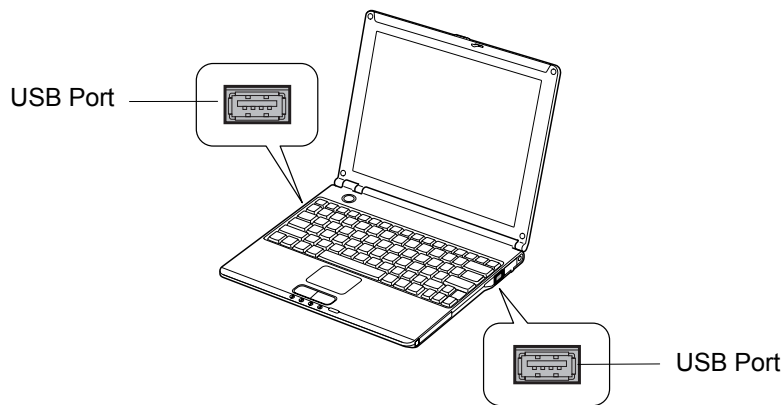

When a new device is correctly connected to your computer, the appropriate driver is automatically installed. If the driver is not installed correctly, you will see the message on the screen. In this case, install the driver with the instructions on the screen.



To remove USB devices, you may need to perform the following instructions before you remove them:

1. Click *Safely Remove Hardware* icon () on the taskbar. If you cannot find the icon, click  to show all kinds of icons. If the icon does not appear, go to Step3.
2. Click *Safely remove xxxx* (xxxxxx is the name of your USB device); then, *Safe To Remove Hardware* dialog appears.
3. Remove the device from your computer.

PC Card

Your computer is equipped with a PC card slot, which can accommodate a Type II card or a CardBus compliant card. You can insert/eject the card without turning off your computer. Before inserting a PC card into the slot, refer to its manual.

Inserting PC Card



When a new card is correctly inserted, the appropriate driver is automatically installed. If the driver is not installed correctly, you will see the message on the screen. In this case, install the PC card driver by following the instructions on the screen.

4

1. Confirm the PC card eject button is inside the cabinet.

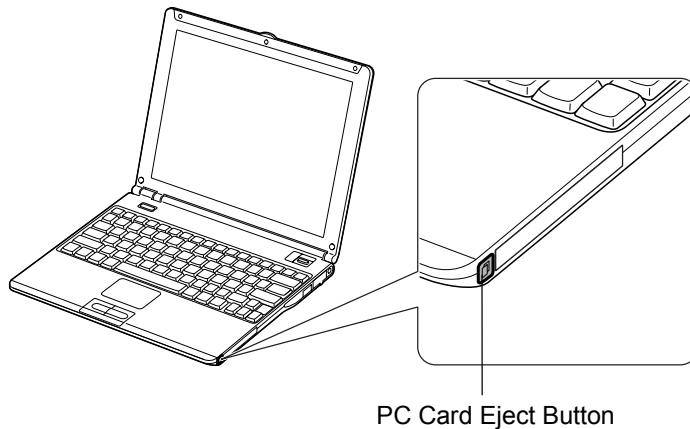

2. Insert a PC card into the slot with the label face up until it locks into place.

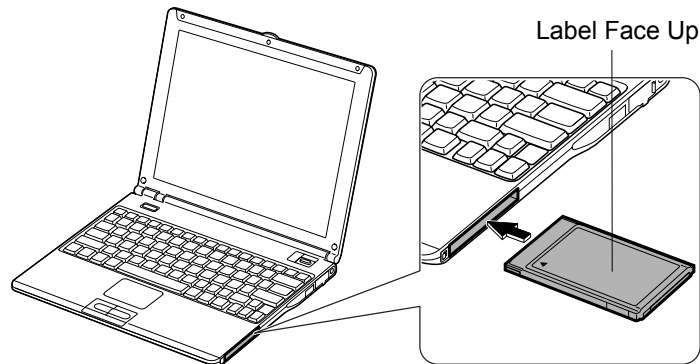



If the dialog box asking you *What do you want Windows to do?* appears, select the task you want.

4

Ejecting PC Card



- *Some PC cards may become hot after long use.*
- *Be sure to use the procedure below when ejecting a PC card. Otherwise, the system may not work properly.*

1. Click *Safely Remove Hardware* icon () on the taskbar. If you cannot find the icon, click  to show all kinds of icons.
2. Click *Safely remove xxxx* (xxxxx is the name of your PC card); then, *Safe To Remove Hardware* dialog appears.
3. Push the PC card eject button so that it will pop out from the side of your computer.

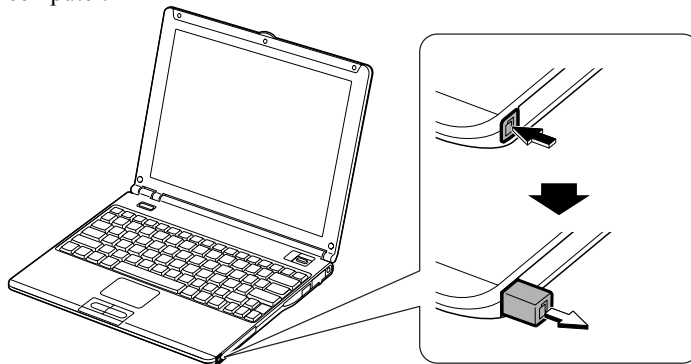

4. Push the eject button until the inserted PC card pops out; then, remove it.

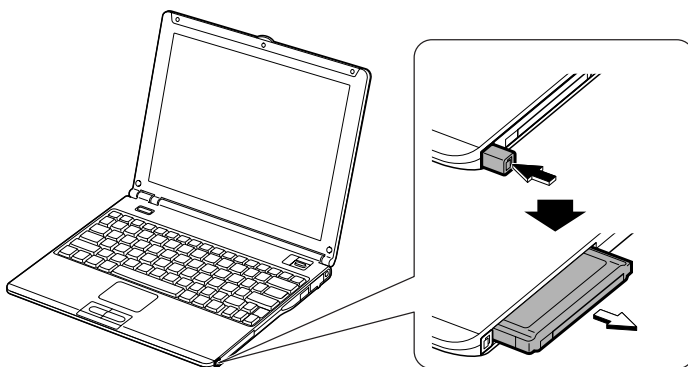

4

5. Push the PC card eject button all the way inside the cabinet for safekeeping.

CHAPTER 5

Communication Functions

This chapter explains how to use the wired LAN unit, the wireless LAN function and the modem card.



- *When you use communication software:*
 - *Connect your computer to the AC power source.*
 - *Disable power management. (Refer to Disabling Power Management of Chapter 3.)*
 - *See also the manual or online help of the software you are using.*
 - *The communication speed may vary depending on the traffic, local telecommunications infrastructure, and ISP (Internet Service Provider) infrastructure.*

5

LAN Unit

You can connect to a LAN (Local Area Network) with the 100 Base-TX/10 Base-T LAN units on your computer. To activate the LAN unit, perform the following steps.



Never insert any cables, but a LAN cable, which have different electric characteristics from those of the LAN cable. Otherwise, the LAN unit and the cables may be damaged.



Use a category 3 or a category 5 LAN cable when connecting to 10 BASE-T LAN, and the category 5 only when connecting to 100 BASE-TX LAN.

Connecting Your Computer to LAN

1. Turn off your computer.
2. Open the cover for the LAN jack on the right side of your computer.

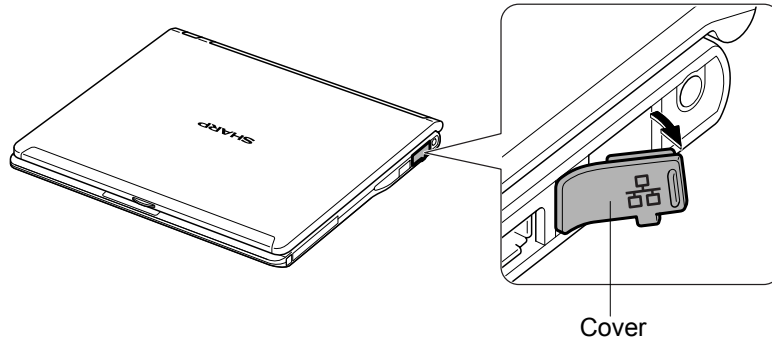

5



To avoid damaging the LAN unit, close the cover after you finish using the LAN unit.

3. Connect one end of the LAN cable to the LAN jack and the other end to the network hub.

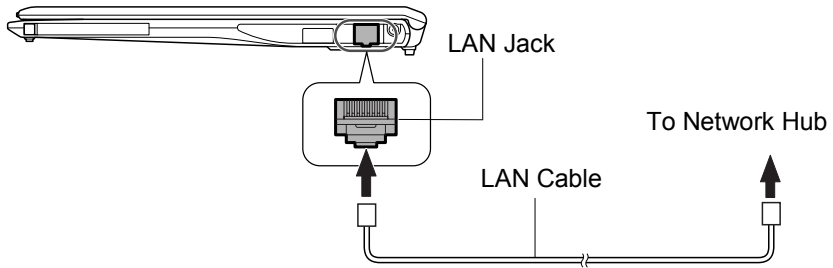

4. Turn on your computer.

Configuring LAN Unit

1. Click *start - Control Panel*.
2. Click *Network and Internet Connections*; then, *Network Connections*. If Classic view is selected, double-click *Network Connections* icon.
3. Right-click *Local Area Connection*.
4. From the pop-up menu, click *Properties*.
5. In the *Local Area Connection Properties* dialog box, set the network setting according to the instruction of your network administrator.



Make sure to log on your computer as a member of the Computer administrators group. Otherwise, you cannot set or change some settings for the LAN unit.

If you cannot access the network,

1. Click *start - Control Panel*.
2. Click *Performance and Maintenance*; then, *System*. If Classic view is selected, double-click *System* icon.
3. Click *Hardware* tab; then, *Device Manager* button.
4. Double-click *Network adapters*, then, *Realtek RTL8139/810x Family Fast Ethernet NIC*.
5. Click *Advanced* tab, and select *Link Speed/Duplex Mode* in *Property* list and select an appropriate value in *Value* pull-down menu.
6. Click *OK* and close the *Device Manager* window.
7. Click *OK* and close the *Control Panel* window.



Removing LAN Cable



*Be sure to push up the locking lever when disconnecting the cable.
Excessive force may result in breaking the locking lever.*

1. Turn off your computer.
2. Push up the locking lever and hold it, then, remove it straight from the LAN jack.

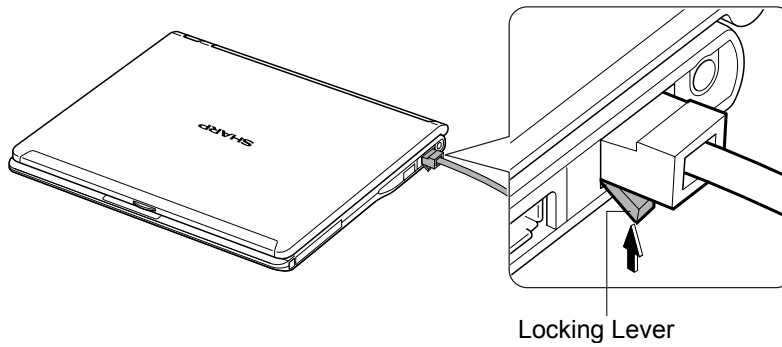

5

3. Close the cover for safekeeping.

Wireless LAN



Your computer has an integrated wireless LAN function compliant with IEEE 802.11g and IEEE802.11b standards. You can access a network using the wireless LAN. There are two kinds of wireless networks: a network using an access point and an adhoc network. You can connect your computer to a wired LAN or the Internet through an access point that is also compliant with IEEE 802.11g or IEEE802.11b standard. The adhoc network consists of a number of computers each equipped with wireless networking interface. Each computer can communicate directly with other wireless enabled computers.



The range to give reliable performance and the quality of connection vary depending on the environment where you perform.

To communicate through the wireless LAN, activate the integrated antenna with the following steps.

Activating Antenna

You can enable/disable the antenna by pressing **Fn+F1** () key combination. When the antenna indicator () lights green, the antenna is enabled. When the indicator light is off, it is disabled.

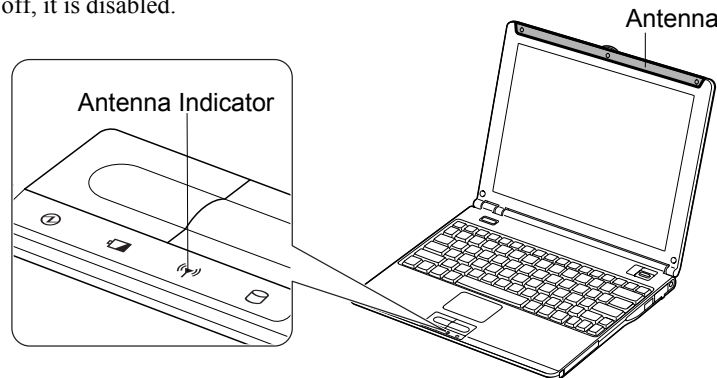

Disable the antenna on airplanes and in specific place where radio-susceptible equipment is nearby such as medical electrical equipment. Electric waves generated from the antenna may affect the devices and cause malfunction of the devices.

Security Measures

Since wireless LAN provides data transfer using electric waves instead of LAN cables between communicating devices, a third party can illegally access to and monitor the transmitted information. The following security measures reduce opportunities to receive the threats. Use a combination of the following measures for more secure communications.



See Notice of Security with Wireless Devices section on page xiv.

Authentication

The following may help you receive less illegal access.

- **SSID (Service Set Identifier)**

“SSID” is a common network name. A SSID acts as a password that is shared with all connecting wireless users, resulting in preventing access by any device that does not have the SSID. Set a same SSID on your computer and access point. Since this may be equivalent to no security, rely on a combination of the SSID and WEP keys. (For details on configuration of an access points, refer to its manual.)

- **MAC (Media Access Control) address filtering**

MAC addresses are unique addresses on the network, which are allocated to the computer’s network interface cards. An access point allows access by a device only if that device’s MAC address matches an address in an authentication list used by the access point. Register your MAC address with your access point. (For more information, refer to the manual of your access point.)



- For other security measures, refer to the manual of your access point.
- To find the MAC address of your computer:

1. Click start – All Programs – Accessories – Command Prompt.
2. Enter `ipconfig/all`; then, press **Enter**.
3. Find the numbers of Physical Address in Ethernet adapter Local Area Connection section. They are the MAC address of your computer.
4. Type `exit`; then, press **Enter**.



WEP (Wired Equivalent Privacy) Encryption

WEP reduces the opportunities for a third party to monitor the information transmitted through wireless LAN network by encrypting the information.

To enable the WEP functions, an encryption key or network key must be registered with both communication devices. In this case, only the receivers who have the correct encryption key can decrypt the information.



- To use the WEP functions, your communication partner must support the functions.
- Your computer supports 128-bit and 64-bit WEP keys.
- For enhancement of security, the encryption keys should be periodically changed.
- The WEP key is generated from ASCII or hexadecimal entries. Refer to the following for the entries.

	ASCII format	Hexadecimal format
Numbers/ Letters	0 to 9, a to z, and A to Z * ¹	0 to 9, a to f, and A to F * ²
Characters/ Digits	5 or 13 characters	10 or 26 digits

*¹ The uppercase and lowercase letters are distinguished.

*² The uppercase and lowercase letters are not distinguished.



Connecting to Internet via an Access Point

You can connect your computer to the Internet or a wired network via an access point supporting IEEE 802.11g or IEEE802.11b. You may need to configure your access point for IP address, DNS server address, and gateway address. Refer to the manual of the access point or consult your network administrator if you are not sure.

This section describes how to configure your computer for wireless communications.

Configuring Wireless LAN Setting



You can store the configured settings using Network Setup Utility, which allows you to easily access to one of the stored networks appropriate to the current environment. (For Network Setup Utility, refer to Network Setup Utility later in this chapter.)



1. Click *start – Control Panel*.
2. Click *Network and Internet Connections – Network Connections*. If Classic view is selected, double-click *Network Connections*.
3. Select *Wireless Network Connection*; then, click *Change settings of this connection* of *Network Tasks*.
4. Double-click *Internet Protocol (TCP/IP)* in *This connection uses the following items*.
5. Confirm the radio buttons of *Obtain an IP address automatically* and *Obtain DNS server address automatically* are selected. If not, select them.
6. Click *Advanced* button.
7. Confirm the *Default gateways* section is emptied. If not, remove the gateway address.
8. Click *OK* each time you close the dialog boxes.
9. Close the *Network Connections* window.

5

Connecting to Network



Before connecting to wireless LAN, confirm your access point is ready to use and powered on. Refer to the manual of your access point.

1. Confirm the antenna indicator is lit.
2. Right-click *Wireless Network Connection* icon () on the taskbar. If you cannot find the icon click  to show all kinds of icon.
3. Click *View Available Wireless Networks*.
4. Select a network to be connected from the list of *Available wireless networks*.
5. Type the network key in the fields of *Network key* and *Confirm network key*.



- *You need to type the correct network key. For available letters or digits, refer to WEP (Wired Equivalent Privacy) Encryption section on page 5-7.*
- *When you select a network that is not configured for encryption settings, the caution message appears such as Allow me to connect to the selected wireless network, even though it is not secure. Although you can connect to the network with the box checked, security is not ensured. Select a security configured network.*



- 
- 
- 
6. Confirm the checkbox of *Enable IEEE 802.1x authentication for this network* is cleared.



Be sure to clear the box for normal use. To enable the IEEE 802.1x in the network, the corresponding settings are required. Consult your network administrator for more information.

7. Click *Connect* button.

Confirming the Status of Wireless Connection

1. Click *Wireless Network Connection* icon () on the taskbar. If you cannot find the icon click  to show all kinds of icon.
2. In *Wireless Network Connection Status* dialog box, confirm your connection status.



- *The number of green signals () shows the connection quality. The more signals light on, the better quality is given to your computer.*
- *When the quality of connection is poor, adjust the distance between your computer and other devices or the access point you are communicating with and/or the facing direction of your computer.*

3. Close the dialog box.



Communicating with Other Computers



- *Confirm each computer is enabled for wireless LAN.*
- *Make sure to log on your computer as a member of the Computer administrators group. Otherwise, you cannot set or change some settings for wireless LAN.*

1. Click *start – Control Panel*.
2. Click *Network and Internet Connections – Network Connections*. If Classic view is selected, double-click *Network Connections*.
3. Select *Wireless Network Connection*; then, click *Change settings of this connection* of *Network Tasks*.
4. Double-click *Internet Protocol (TCP/IP)* in *This connection uses the following items*.



- 
- 
- 
5. In *Internet Protocol (TCP/IP) Properties* dialog box, select *Use the following IP address* and set a unique *IP address* to 192.168.1.2 through 192.168.1.254 and the *Subnet mask* to 255.255.255.0; then, click *OK*.



- *The IP address of each computer should be unique.*
- *The same subnet mask should be set to the other computer.*
- *The Default gateway can be blank.*

6. Click *Wireless Networks* tab; then, *Advanced* button in the lower right of the dialog box. *Advanced* dialog box appears.
7. Select *Computer-to-computer (ad hoc) networks only*; then, click *Close* button.
8. Click *Add...* button in *Preferred networks* of *Wireless Network Connection Properties* dialog box.
9. Type a name of the network in *Network name (SSID)* field of *Wireless Network Properties* dialog box.



5



Confirm your computer and the other computer(s) are connecting to the same network.

10. Confirm the checkbox of *Data encryption (WEP enabled)* is checked in *Wireless network key (WEP)* section.
11. If necessary, check the checkbox of *Network Authentication (Shared mode)*.
12. Clear the checkbox of *The key is provided for me automatically*.
13. Type a network key in *Network key* and *Confirm network key* fields.



- *The network key to be typed must be equal to that of the other computer.*
- *For available letters or digits, refer to WEP (Wired Equivalent Privacy) Encryption section on page 5-7.*

- *Be sure to match the key index between your computer and the network/the other computer. Note that some access points and computers have the key index options 0 through 3. Refer to the table below for matching.*

Access Point 1 /Computer 1	Access Point 2 /Computer 2	Your computer
1	0	1
2	1	2
3	2	3
4	3	4

(ex. When your access point type is “Access Point/Computer 2” and its key index is set to 0, set 1 to the key index of your computer.)

14. Click *OK* twice; then, close the *Control Panel* window.
15. Configure the network by setting the name of your computer and workgroup.



To communicate with other wireless enabled computers, set your computer name and the workgroup name. Your computer name should be unique and the workgroup name should be same as others.



5

Network Setup Utility

With the Network Setup Utility, you can set up your specific network settings adjusted for your environments such as work, home, etc. and select the appropriate one to the environment. You can also change the network settings.



- *Not every setting item can be stored.*
- *The Network Setup Utility may not be compliant with all network environments.*

Loading Network Settings

To set your specific network settings, confirm that your computer is connected into the network and has the proper settings for your current environment and follow the instructions below.

5

1. Click *start – All Programs – SHARP Network Setup Utility – SHARP Network Setup Utility*.
2. Click *OK*.
3. Click *Set*, select *SHARP icon* or *Windows icon*, then, click *Select icon* button.
4. Select an icon and click *OK*. Type a network name, then, click *OK*. The selected icon appears in the *Network Setup Utility* window.



It takes a moment to load the network settings.

Switching Network

To switch the network set above, confirm your computer is ready to connect into the network and follow the instructions below.

1. Click *start – All Programs – SHARP Network Setup Utility – SHARP Network Setup Utility*.
2. Click *OK*.
3. Select the appropriate network icon in the *Network Setup Utility* window.
4. Click *OK*.



- *Make sure your computer is connected to the proper environment.*
- *If your hardware or software configuration has been changed, you may*

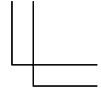

not be able to switch to the network properly. In this case, you may need to reconfigure the settings.

Changing Network Settings

To change the loaded network settings, right-click on the icon you want to change the settings in the *Network Setup Utility* window and click *Edit settings* in the pop-up menu. Then, edit the settings.

Deleting Network

To delete the loaded network settings, right-click on the icon you want to delete in the *Network Setup Utility* window and click *Delete setting* in the pop-up menu. Then, click *OK*.

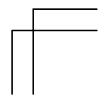
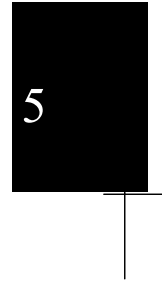
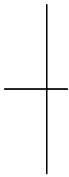

Modem Card

Your computer comes with the modem card. In order to use the modem on your computer, install the supplied modem card in your computer.



- *The modem in your computer is designed only for regular analog telephone lines. The modem may be damaged when connected to a digital ISDN terminal or a digital PBX.*
- *Use TA (terminal adapter) to connect the built-in modem to a digital telephone line.*
- *If an unusual device is attached to the line you are connecting to, the modem may not function properly. Remove the device or contact the dealer of the device.*
- *Before connecting to a PBX, consult the PBX maintenance staff or its service company. If the electric characteristics of your PBX are different from those of a regular analog line, the modem will not function properly. If you connect the modem to a digital PBX, both the modem and the PBX may be damaged.*

5

Installing Modem Card

This card is ready for Windows XP. To communicate using the modem card, follow the instructions below:

1. Gently insert the modem card into the PC card slot. Make sure the card is firmly seated in the slot.

This modem card is ready to use.

Connecting Modem to Telephone Line

1. Turn off your computer.
2. Connect PC card connector end of the included modem cable to the connector of the inserted modem card.
3. Connect the modular jack end of the modem cable to the telephone line.
4. Turn on your computer.



Connect the modem to the telephone line directly. Do not use a distributor or allotter.

Configuring Modem

Configure your modem making the necessary adjustments as shown below.

Modem Configuration



When you use the modem first time, you must type your location's information.

1. Click *start - Control Panel - Printers and Other Hardware*; then, *Phone and Modem Options*. If Classic view is selected, double-click *Phone and Modem Options* icon.
2. In *Location Information* dialog box, select your country, type your area code, etc., and select your dial type; then, click *OK*.

After the configuration, click or double-click *Phone and Modem Options* (icon) to open *Phone and Modem Options* dialog box and double-click the location name of *Locations* in *Dialing Rules* tab for the information you set above.

You can change the settings or make a new location by clicking *Edit...* or *New...*

Removing Modem Card

1. Click *Safely Remove Hardware* icon () on the taskbar. If you cannot find the icon, click  to show all kinds of icons.
2. Click *Safely remove xxxx* (xxxx is the name of your modem card); then, *Safe To Remove Hardware* dialog appears.
3. Push the PC card eject button so that it will pop out from the side of your computer.
4. Push the eject button until the inserted PC card pops out; then, remove it.

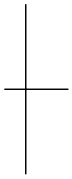

CHAPTER 6

Setup Utility

This chapter describes how to run the Setup Utility to change settings on your computer.

Running Setup Utility

With the Setup Utility, you can customize the system configuration information, such as time and date, port assignments, or passwords. The information you have specified is saved in a special area called CMOS RAM, which the system reads every time you turn on your computer. Your computer is shipped from the factory with the appropriate setting of the Setup Utility. Leave it as default in normal use.

Contents of Setup Utility

The Setup Utility consists of five menu pages, as follows:

- Main: Configures basic setting
- Advanced: Configures device interface
- Security: Sets Passwords
- Boot: Sets where the system boots from
- Exit: Exits the Setup Utility or returns to the default values

Entering and Exiting Setup Utility

1. Turn on your computer.
2. When *Press F2 for System Utilities* appears, press **F2**.
3. Change to the desired settings. Refer to the next section.
4. Select *Exit* menu.
5. Select one of the exit methods and press **Enter**.
6. Confirm the message and press **Enter** again. The system may restart according to the exit method .



When the Setup Utility is opened, power management does not work. Do not close the display cover.

Changing Setting of Setup Utility

To change the settings:

1. Use → or ← key to select the menu.
2. Use ↑ or ↓ key to select the item.

Minus or **Space** key : Changes the value.

In the item with ►mark, press **Tab** or **Enter** to open a sub menu. Press **Esc** to close the sub menu and return to the previous menu.

For date and time, press **Enter** on the item to select the value you want to change; then, use minus key or space bar to change the value.

3. Close the Setup Utility by following the steps above.



Main Menu

System Time defines the system time, using the format *hour:minute:second* (24-hour format). Use **Tab** or **Enter** key to move the cursor, and minus key or space bar to change numerals.

System Date defines the system date, using the format *month/day/year*. Use **Tab** or **Enter** key to move the cursor, and minus key or space bar to change numerals.

Hard Disk Type shows the type of the hard disk of your computer, and normally has to be as default. Press **Enter** key to show the details.

Internal NumLock defines whether the numlock keys of the built-in keyboard are always disabled or not. (An external keyboard will be numlocked if connected.)

Quick Boot defines whether the system simplifies the internal check while booting, to shorten the boot time.

Quiet Boot defines whether the SHARP logo appears on the screen while booting.

CPU Information shows the information on the CPU.

System Memory shows the volume of the conventional memory used in MS-DOS.

Extended Memory shows the volume of the extended memory more than 1MB.

BIOS Version shows the BIOS version of the system.

EC/KBC Version shows the EC/keyboard controller version of the system.

CMS Version shows the CMS version of the system.

DirectHD Version shows the DirectHD version of the system.

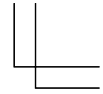

Advanced Menu

Internal Pointing Device enables or disables the built-in glide pad.

Resolution Expansion defines whether the Setup Utility screen is expanded when the resolution is 640x480 or 800x600. *Enabled* means that the screen is expanded.

Plug&Play O/S normally has to be as default “Yes”.

Max ACPI C-State normally has to be as default “C4 State”.

PCI Configuration normally has to be as default

Security Menu

Set Supervisor Password defines the supervisor password (up to eight characters). See the next section about the supervisor password.

Set User Password defines the user password (up to eight characters). You can set the user password only when you have set the supervisor password. See the next section about the user password. This password is used on the connection cradle.

6



If you lose your password, you will be unable to access your computer or change the configuration. Make sure to select a password you will never forget, or write it down and protect it in a secure place. Otherwise, you will have to contact your dealer for assistance.

Password On Boot defines whether you have to type the password for booting your computer.

Hard Disk Boot Sector defines whether the boot sector of the hard disk is write-protected. When formatting the hard disk or reinstalling software, set to *Normal*.

Supervisor and User Password

Setting a password will protect your computer against unauthorized access. Once a password is set, the system requires the password when entering to the Setup Utility. And if *Password on boot* is enabled, the system will require a password when your computer is turned on.

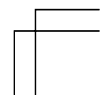



If you enter a wrong password three times, the message System Disabled appears. Press the power button to shut down your computer, and after 10 seconds, press the power button to turn it on again.

Your computer supports two different levels of password security: Supervisor password and User password. You cannot set a user password unless you have set a supervisor password. If you share your computer with others, we recommend that you set both the supervisor and the user password, and let others know the user password only.

If you type the user password when you enter the Setup Utility, you can change *System Time* and *System Date* of the *Main* menu, *Resolution Expansion* of the *Advanced* menu and *Set User Password* of the *Security* menu only.

Setting Password



1. In the *Security* menu of the Setup Utility, select *Set Supervisor Password* or *Set User Password* and press **Enter**.
2. Type your password (up to eight characters), and press **Enter**.
3. Type the same password again, and press **Enter** twice.
4. Select *Exit* menu and confirm *Exit Saving Changes* is highlighted; then press **Enter**.
5. Confirm *Yes* is highlighted and press **Enter**. The system restarts.

Changing Password

1. In the *Security* menu of the Setup Utility, select *Set Supervisor Password* or *Set User Password* and press **Enter**.
2. Type your current password, and press **Enter**.
3. Type your new password, and press **Enter**.
4. Type your new password again, and press **Enter** twice.
5. Select *Exit* menu and confirm *Exit Saving Changes* is highlighted; then press **Enter**.
6. Confirm *Yes* is highlighted and press **Enter**. The system restarts.

Deleting Password

1. In the *Security* menu of the Setup Utility, select *Set Supervisor Password* or *Set User Password* and press **Enter**.
2. Type your current password, and press **Enter**.

- 
- 
- 
3. Without typing any characters, press **Enter**.
 4. Press **Enter** twice.
 5. Select *Exit* menu and confirm *Exit Saving Changes* is highlighted; then press **Enter**
 6. Confirm *Yes* is highlighted and press **Enter**. The system restarts.

Boot Menu

Boot Sequence specifies where the system boots from. Press **Enter** to open the sub menu. The system boots from the drive at the top of the list. If the system cannot find the drive, it will boot from the second one; then, third one; then fourth one. Use arrow keys to select the drive you want to move; then, use space bar or minus key or to move it up or down.

USB Boot enables or disables the boot from the USB floppy disk drive or the USB CD drive.

LAN Boot defines whether the system boots from other server via the LAN unit of your computer.

6

Exit Menu

Exit Saving Changes saves the settings you have changed and exits the Setup Utility.

Exit Discarding Changes exits the Setup Utility without saving the settings you have changed.

Load Setup Defaults returns the values of all items to the default. To exit, select one of the above items.

Discard Changes returns the values of all items to the values you last saved. To exit, select one of the above two items.

Save Changes saves the settings you have changed. To exit, select one of the above two items.

CHAPTER 7

Connection Cradle

This chapter describes how to use the connection cradle with your computer (hereafter called MM series). Using the connection cradle, you can connect the MM series to another computer (hereafter called host computer).



- *Never insert anything but the MM series into the connection cradle.*
- *Be sure to keep the inside of the connection cradle, especially the connector, free from dust or any foreign objects. This may cause malfunction and bad connection.*
- *Place the connection cradle on a stable and even work surface.*
- *When the connection cradle is connected to the host computer, do not give a shock or vibration to the connection cradle.*
- *During data communication to the host computer, set the time of the MM series and the host computer synchronized. When you modify the file, the time you modify the file is recorded in the Properties of the file. If the time in the host computer is not the same as the time in the MM series, you will not be able to properly manage the files by the modification date.*

Precautions When Backing Up And Restoring Data

In order to secure the proper backup and restore, follow the instructions below during data backup and restore:

- Always connect the AC adapter to the connection cradle.
- Do not remove the MM series from the connection cradle.
- Do not disconnect the USB cable connecting the connection cradle and the host computer.
- Do not slide the connection switch.

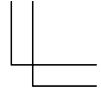
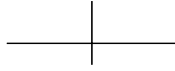

Installing Application Program

You cannot install an application program to the MM series from the host computer when the MM series is inserted in the cradle. In order to install an application program into the MM series, do either of the following performance:

- Connect the external CD drive unit to the MM series.
- Connect the MM series to the host computer via LAN and share the CD drive of the host computer with the MM series.



Before installing an application program, carefully read its license agreement.

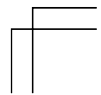
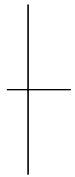

Overview of Connection Cradle

Front Panel

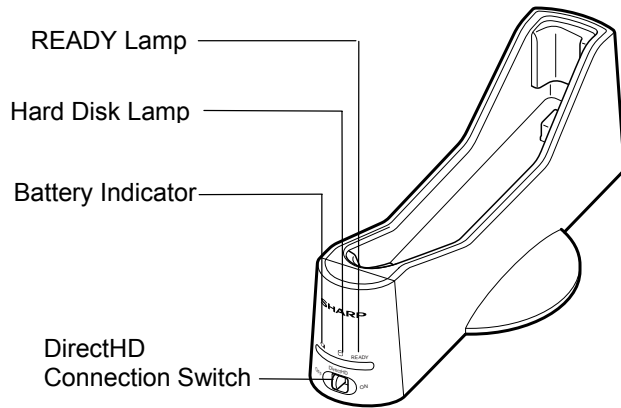

Rear Panel

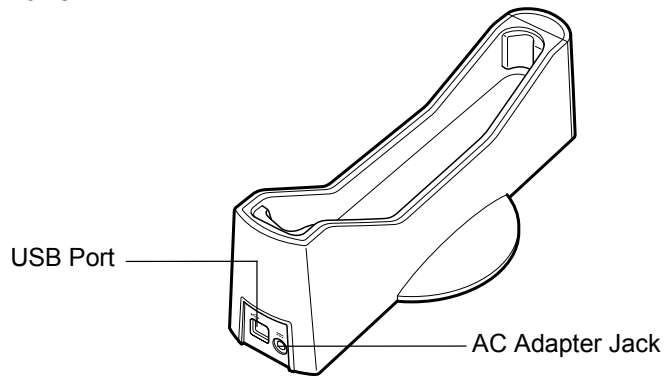

7

Charging Battery Pack Using Connection Cradle

1. Place the connection cradle on a stable and even work surface.
2. Connect the AC power cord to the AC adapter (1).
3. Plug the AC adapter cable to the AC adapter jack on the rear side of the connection cradle (2).
4. Plug the AC power cord to the wall outlet (3).

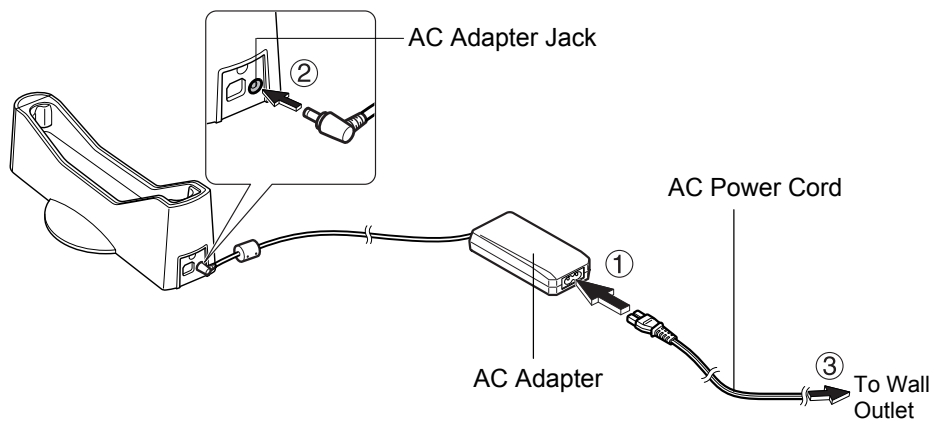

Always use the AC adapter and the AC power cord included with your computer or the optional one. Using others may damage to the connection cradle.

5. Make sure that no foreign materials such as dust are inside the connection cradle.



Do not install the MM series in the connection cradle with foreign body inside, such as dust. This may damage both the MM series and the connection cradle, and result in bad connection.

6. Insert the MM series into the connection cradle with its left side downward until the MM series is firmly secured to the connection cradle. Charging will start.

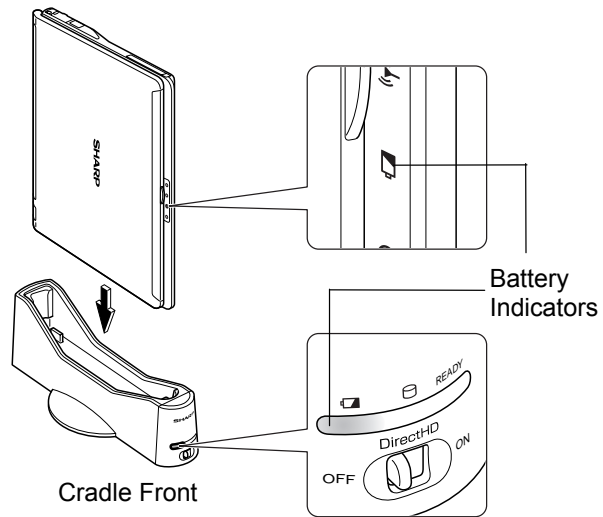

When the MM series and the connection cradle are properly connected, their both battery indicators will light and charging will be started.



Connecting to Host Computer

Using MM Series as External Hard Disk

Using the connection cradle allows you to use the MM series as an external hard disk of your host computer. You can read and modify the data on the MM series and also store the data into the MM series, which is powered off, without any media or LAN function.

Host computer

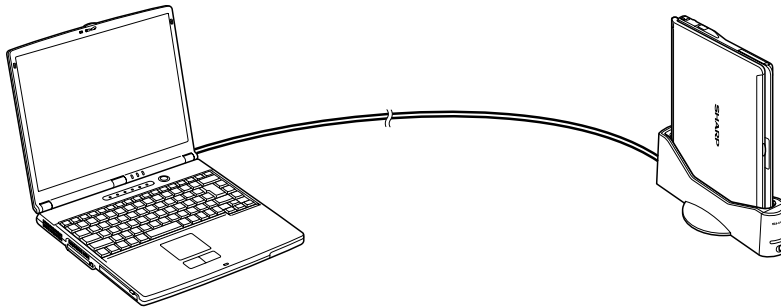

The MM series can be used as an external hard disk of your host computer with one of the following operating systems installed:

- Microsoft Windows XP Home Edition/Microsoft Windows XP Professional (hereafter called Windows XP)
- Microsoft Windows 2000 Professional (hereafter called Windows 2000)
- Microsoft Windows Millennium Edition (hereafter called Windows Me)

Before connecting the MM series to the host computer for the first time, be sure to install the connection cradle program (described later).

Limitation

You cannot use the MM series as an external hard disk when it is powered on or in the system standby/hibernate state.

When the Host Computer is Windows XP

Log on to the computer as a member of the Computer administrators group. You might not install application programs when you log on to the computer with a limited account.

When the Host Computer is Windows 2000 or Windows Me

Install an application program when you log on to the computer as a member of the Computer administrators group. And Use the installed program when you log on to the computer as a member of the Computer administrators group.

Installing Connection Cradle 2 Program

The following shows how to install the connection cradle program to the host computer.

1. Insert the product recovery CD-ROM disk 3 in the CD drive of the host computer.
2. Double-click *My Computer* , then double-click *the CD drive* icon.
3. Double-click the *SOFTWARE* folder, then double-click the *MCX 2* folder. The *Connection Cradle Setup Wizard* starts up. Follow the message on the screen and install the Connection Cradle 2 program.
4. Install the program according to the instructions on the screen.

7

Connecting MM Series to Host Computer

First Connection

The following shows how to connect the MM series to the host computer for the first time using the connection cradle.



Do not connect the USB cable until instructed to do so (in Step5 below).

1. Install the Connection Cradle 2 program to the host computer (shown on the previous page).

- Turn off the MM series.



You cannot connect the MM series to the host computer when the MM series is powered on or in the standby/hibernate mode.

- Connect the AC adapter to the connection cradle and insert the MM series into the connection cradle. (Refer to *Charging Battery Pack Using Connection Cradle* on 7-4.)
- Make sure the battery indicator on the connection cradle is powered on and slide the DirectHD connection switch on the connection cradle to *OFF*.

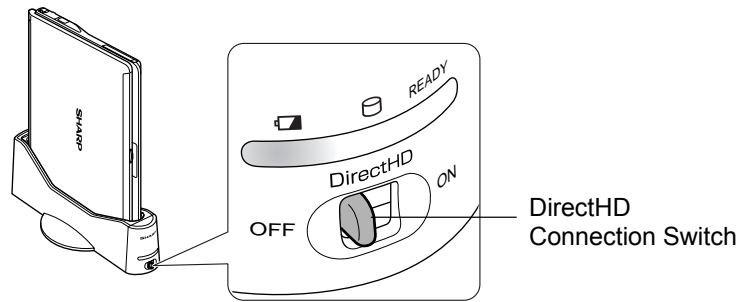

- Connect the connection cradle with the host computer using the supplied USB cable.

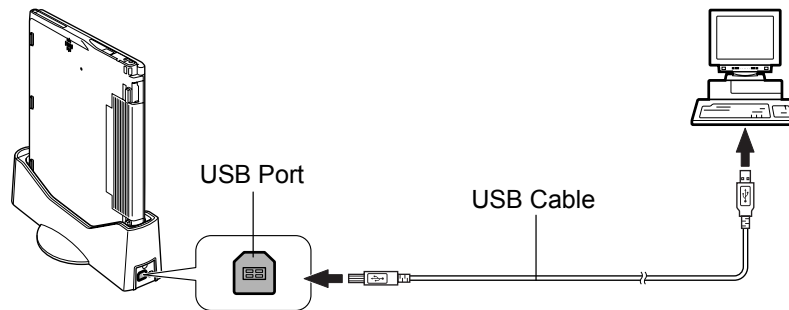

7

6. Slide the DirectHD connection switch on the connection cradle to the *ON* position. The *READY* indicator on the connection cradle will be turned green.

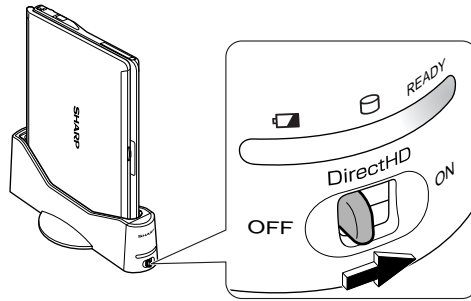

- *When you connect the connection cradle to the host computer for the first time, necessary drivers are automatically installed. Wait until installation process completes.*
- *When the host computer runs on Windows XP, you might get the screen asking you what you want Windows to do. In this case, click Cancel.*

Second or Later Connection

From the second time on, you can connect the connection cradle to the host computer in any order. When the connection cradle is connected to the host computer and the connection switch is ON, the host computer can recognize the MM series as its external hard disk only by inserting it into the connection cradle.



- *When connected to the host computer, the connection cradle must be powered by the AC adapter. Using the connection cradle without the AC adapter connected may cause the data loss if the battery of your computer is completely discharged and if you have not saved the data at that time.*
- *If the battery of your computer is completely discharged when connected to the host computer, the connection is suddenly cancelled and an error message will be displayed on the host computer's screen.*

Displaying on Host Computer

Once the MM series is recognized as an external hard disk of the host computer, it is shown as *XXX (E)* or as *XXX (F:)* with the icon representing the MM series inserted in the connection cradle in the *Hard Disk Drives* section on Windows XP or in the *My Computer* window on the other operating systems.





- *The drive names such as (E:) and (F:) differs depending on the environment of the host computer.*
- *If you set a user password to the MM series in the Setup Utility, the MM series is shown not as hard disk drive, but as removable disk drive with the icon representing the MM series inserted in the connection cradle with the key mark. In order to access to the hard disk of your computer, delete the password temporarily. See Canceling Password in Setting Password section later in this chapter.*



- While communicating to the host computer;*
- *Keep the AC adapter connected to the connection cradle.*
 - *Do not remove the MM series from the connection cradle.*
 - *Do not move the connection cradle and the MM series. It may result in disconnecting the cable between the host computer and the connection cradle.*
 - *Do not operate the DirectHD connection switch.*

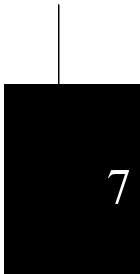

Synchronizing MM series with Host Computer

You can synchronize files or folders on your MM series and on your host computer. You need to install the SharpSync application (stored on the provided Product Recovery CD-ROM Disk3) onto your host computer for synchronizing.



During data communication, set the time of the MM series and the host computer synchronized. When you update the file, the updated time is recorded. If the time in the host computer is not the same as the time in the MM series, you will not be able to properly manage the files by the modification date.

Supporting Operating System

The SharpSync application supports the following operating systems:

- Microsoft Windows XP Home Edition/Microsoft Windows XP Professional (hereafter called Windows XP)
- Microsoft Windows 2000 Professional (hereafter called Windows 2000)

Installing SharpSync Application and Setting Up Synchronization

The SharpSync application is stored on the provided Product Recovery CD-ROM Disk3.



Be sure to install the application on your host computer.

1. Connect your MM series and your host computer. (Refer to the *Connecting MM series and Host Computer* section in this chapter.)
2. Insert the provided Product Recovery CD-ROM Disk3 into the optical drive of your host computer.
3. In *My Computer*, double-click the CD icon to open the CD-ROM.
4. Double-click the \SOFTWARE\SHPSYNC folder and then the *setup* icon to start the application installation.
5. Follow the instructions on the screen. When the installation process is successfully completed, the *Enable SharpSync Drive* wizard will start.
6. Click *Next*.

7. Select a destination drive of your MM series for the synchronization and then click *Next*.
8. Follow the on-screen instructions.



After completing the installation of the SharpSync application, ISYNC folder, autozip.run, Autozip.bak and setup.exe may be automatically installed in the destination drive of your MM series. Do not delete the folder and files in order to keep SharpSync software working.



- *The preset sync target files are doc, xls, pdf, ppt, bmp, avi and jpg. You can add other file extensions and also remove the above extensions. (Refer to the Adding/Removing Sync Target File section later in this chapter.)*
- *See the Help menu of the SharpSync for more information.*
- *After setting up the synchronization, the synchronized files will be recognized on your host computer whenever connecting your MM series with your host computer.*
- *When installing the application into your MM series, be sure to directly install it. You cannot install through your host computer.*
 1. *Turn on your MM series.*
 2. *Insert the CD-ROM into the optical drive of your MM series.*
 3. *Follow the on-screen instructions.*

7

Adding Sync Set

After installing the SharpSync application and setting up the first synchronization, you can add another sync set.



Confirm that your MM series is connected with your host computer and the DirectHD status indicator is lit.

1. Double-click the *SharpSync* icon on your host computer's desktop.
2. Click *Add New Set* button.
3. Follow the instructions on the screen.

Stopping Synchronization

You can stop the synchronization between your MM series and host computer without deleting the Sync set.



Confirm that your MM series is connected with your host computer and the DirectHD status indicator is lit.

1. Double-click the *SharpSync* icon on your host computer's desktop.
2. Select a desired Sync set.
3. Select *Don't Sync* from the pull-down list.



To restart the synchronization, select Sync from the list.

Adding Sync Target File Extensions

You can add a target file extension(s) by editing settings. Follow the instructions below:

1. Right-click the *SharpSync* icon on the taskbar.
2. Click *Open Control Panel...*
3. Choose the "Sync Set" of which you want to change the condition.
4. Click *Edit Set*.
5. Click *Filters*, then you can find the extensions that will be synchronized on the right side box.
6. Choose a file extension you want to add to the synchronization target files from the left side box.
7. Click *Add*.



- *When you add more than one extension, repeat the step 6 to 7.*
- *If you want to synchronize all the data inside of chosen folder, select ALL Files.*

8. Click *OK* three times.



If you want to remove the target extensions, select the extension(s) to be removed in the right box and click Remove.

Stopping Connection from Host Computer

You can stop the connection from the host computer while keeping the MM series inserted in the connection cradle, by first stopping the device on the host computer then sliding the DirectHD connection switch of the connection cradle to *OFF*.



Be sure to stop the device before sliding the switch on the connection cradle to OFF. Otherwise the data may be lost or to the MM series may be damaged.

Stopping Device

Here we explain assuming that the hard disk drives C and F of the MM series is assigned to drives F and G of the host computer. If not, please replace the drive names with the appropriate ones.

On Windows XP

1. Click *Safely Remove Hardware* icon () on the taskbar.
2. Click *Safely remove USB Mass Storage Device – Drives (G:,F:)*; then, *Safe To Remove Hardware* dialog appears.

On Windows 2000

1. Click *Safely Remove Hardware* icon () on the taskbar.
2. Click *Safely remove USB Mass Storage Device – Drives (G:,F:)*; then, click *OK*.

On Windows Me

1. Click *Safely Remove Hardware* icon () on the taskbar.
2. Click *Safely remove USB Disk – Drive(G:,F:)*; then, click *OK*.

Sliding DirectHD Connection Switch to OFF

1. Stop the device.
2. Slide the connection switch on the connection cradle to the *OFF* position. The *READY* indicator turns off.

Connecting to Host Computer Again

While you keep the MM series inserted in the connection cradle, slide the connection switch back to *ON* to connect to the host computer again.



When you do not remove the MM series from the connection cradle after stopping the device, the connection is stopped, although the READY indicator is on. To regain the connection, slide the DirectHD connection switch to OFF, then back ON again.

Disconnecting USB Cable

When disconnecting the USB cable from the host computer and the connection cradle, be sure to stop the device before disconnecting the cable.

Removing from Connection Cradle

To remove the MM series from the connection cradle, follow the steps below:

1. Stop the device first.



Be sure to stop the device before removing the MM series from the connection cradle. Otherwise the data may be lost and the MM series may be damaged.

2. Set the DirectHD connection switch to the *OFF* position. The *READY* indicator on the connection cradle turns off.
3. Hold the stand plate of the connection cradle by your hand, and pull up the MM series out of the connection cradle.

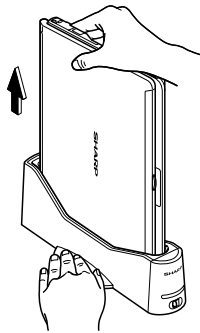

Setting Password

You can set a “user password” to your computer to avoid unauthorized use of the hard disk of the MM series when it is connected to the host computer using the connection cradle.



Set the Supervisor Password and User Password in the Setup Utility.

Setting Password

Set a user password of the MM series in the Setup Utility. For setting the password, see *Security Menu* in Chapter 6.

Canceling Password

Cancel the password temporarily when you want to use the MM series as an external hard disk of your host computer.

1. Connect the MM series with the host computer.
2. Click *start – All Programs – Connection Cradle 2 – Password Utility*. *Password Utility* window appears.
3. Type the current user password in the *Password* box and click *OK*.
4. When you see the message *Releases the Security*, click *OK*.
5. The password is cancelled and the hard disk drives of the MM series are recognized as external hard disk drives of the host computer.



In some cases, an alert box may appear. This is because once the password is cancelled, the device is stopped and then, the connection cradle is connected. This causes no matters.

Deleting Password

On Windows XP or Windows 2000

When the host computer is Windows XP or Windows 2000, delete the password set to the MM series in the Setup Utility. For details, see *Security Menu* in Chapter 6.

On Windows Me

When the host computer is Windows Me, cancel the password set to the host computer, before deleting the user password in the Setup Utility of the MM series.

1. Cancel the password.
2. Stop the device.
3. Remove the MM series from the connection cradle.
4. Run the Setup Utility on the MM series and delete the user password. (For details on deleting the password, see Chapter 6.)



Be sure to cancel the password using Password Utility (see the previous page) before deleting the password. Otherwise, the MM series will be recognized as a removable disk, when you connect the MM series to the host computer second time.

In order to make the MM series recognized as an external hard disk again, do the following:

1. *Connect the MM series to the host computer.*
2. *Open the Password Utility and type the user password.*
3. *Click Cancel.*
4. *Stop the device.*
5. *Turn off the DirectHD switch on the connection cradle.*
6. *Turn on the DirectHD switch on the connection cradle.*

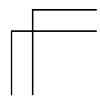
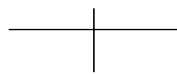
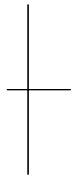
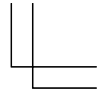

Appendixes

The appendixes contain additional information on the use and care of your computer.

Maintenance and Care

This appendix provides you with information on how to maintain your computer in excellent working condition.

Cleaning Your Computer

Cabinet

Apply a small amount of mild cleaning solution to a dry, lint-free cloth and wipe the cabinet with the cloth.



- *Never clean your computer while it is powered on.*
- *Do not use alcohol, benzene, thinner or other strong chemical agents that may damage the cabinet.*

Screen

The surface of the screen may become smeared and accumulate dust during use. Avoid touching the screen with your fingers when using the system. Gently wipe the surface of the screen with a soft cloth that has been dipped in a mild detergent solution and squeezed dry.

Glide Pad

Wipe the glide pad with a soft, dry cloth.

Ventilation Openings

Dust on the ventilation openings may cause overheating of your computer. Wipe the ventilation openings with a soft, dry cloth.

Traveling With Your Computer

This computer is designed for portability. For safety and convenience when traveling, please follow these guidelines.

- Before traveling, back up your data on floppy disks or other external media.
- Do not travel with any peripheral devices connected such as an optional external floppy disk drive unit or the optional external CD-ROM drive connected.

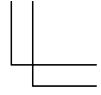
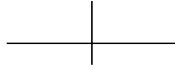

- Do not carry your computer powered on. This may result in loss of data and/or damage to the hard disk drive.
- Make sure the display cover is closed before traveling. Otherwise, the cover may be opened unawares, and the display or the keyboard will be damaged.
- If you carry your computer in a bag, try to avoid unnecessary pressure, caused by the stuff of the bag, to your computer.
- Disconnect the AC adapter from your computer.
- Fully charge the battery pack and bring the AC adapter and the AC power cord.
- Avoid sudden shocks or extreme vibration.

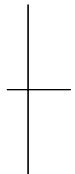
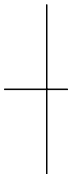

Appendixes

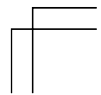



Virus Infection Protection

Computer viruses are referred to a kind of malignant programs intentionally engineered. When your computer is infected, several damages would be generated; data in the hard disk may be destructed; your computer may be provided external operation by unauthorized users; you may inadvertently attach infected files to your e-mails resulting in spreading the viruses, for example.

The following infection route would be currently considered:

- Data attached to e-mail
- Files downloaded from the Internet
- Files stored on media such as diskettes or CD-ROMs



The data or files from the outside may have computer viruses, however, your computer cannot be infected just by downloading the data or files to the hard disk. Opening the infected files or running the programming files can result in activating the virus programs and then, your computer will be infected.

When you receive odd data or files, do not open them until you have confirmed they are legitimate.

To avert virus infection, the following measures are encouraged:

- Install the latest virus protection software into your computer.
- Apply the latest virus definition file for prevention of new virus attack.
- Back up your important data regularly.
- Do not insert diskettes or CD-ROMs originated from unknown place into your computer.
- Disable macros when handling files that may contain a virus.

You can download software that disables macros from the URL of Microsoft Corporation below as a countermeasure against increased files (word or excel) containing any macro virus.

<http://www.microsoft.com/security/>

When virus infections occur

Eliminate the virus by means of the latest anti-virus software or programming software. When it fails, reinstall all the hard disks. (For reinstalling the hard disks, refer to *Appendixes*.)

Protecting Your Computer Against Virus

Norton AntiVirus software is prepared for installation into your computer for detecting and eliminating viruses. Some of the software features are below:

- Regularly updates itself to maintain the latest program and virus definition file against new virus threats. (LiveUpdate)
 - Automatically scans all incoming messages and attachments so that viruses can be identified and blocked. Also detects viruses intruded into your computer. (Auto-Protect)
 - Manually detects infected programs or files. (Virus Scan)
- Refer to *Help* of the installed *Norton AntiVirus* for more information.

Installing Software

Follow the instructions below for installing the Norton AntiVirus software.



1. Double-click *Norton Setup* icon () on the desktop of your computer.



If the Norton Setup icon () is accidentally removed from the desktop, follow the steps below for starting the Norton Setup wizard.

Click start – Run....

Type C:\navsetup\navsetup.exe in the Open field, and click OK.

2. Install the software by following the on-screen instructions.
When the installation is completed, the *Norton AntiVirus* icon () will be displayed on the desktop.
3. Double-click *Norton AntiVirus* icon () on the desktop.
The *Norton AntiVirus Wizard* will start.
4. Complete the wizard by following the on-screen instructions.

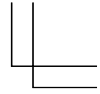

Norton AntiVirus Update Service

Norton AntiVirus software scans for virus by means of a virus definition file allowing the software to identify and block a particular virus. To protect your computer against new viruses, the virus definitions and application need to be kept current. The software automatically checks the web and updates the definition file when needed. Free update service will be provided within ninety days since the software is installed. After the free service is over, one-year paid update service can be available. Refer to <http://www.symantec.com> for application.

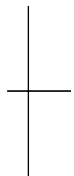
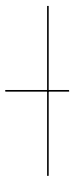

Appendixes

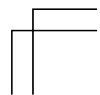



Data Backup and Restore

Your important data such as e-mails or files is stored on the hard disk of your computer. Backing up the data in another place is one of the ways that protect your data against any disaster, data corruption or data erase, for example.

Backing Up Your Data

The *File and Settings Transfer Wizard* can help you to back up several files and settings at one time. To open the wizard, follow the instructions below.

1. Connect the backup device or media to your computer.
2. Click *start – All Programs – Accessories – System Tools – File and Settings Transfer Wizard*.
3. Follow the on-screen instructions.



You can also back up the data on your host computer by using the connection cradle. (Refer to Chapter 7.)

Restoring Your Data

You can also use the *File and Settings Transfer Wizard* to restore your data or settings from the backup media to the hard disk.



When restoring your backup data, the wizard asks you if you try to overwrite a file that already exists on the hard disk. Make sure the backup data is the one you want before overwriting the existing file.



Re-installation Instructions

To recover your hard disk, you will use PowerQuest®EasyRestore™. Before starting re-installation, read the following End User License Agreement first.

PowerQuest(R) EasyRestore (TM) End User License Agreement

IMPORTANT: Read this before using your copy of PowerQuest software.

This document is a legal agreement between you, the "end user," and PowerQuest Corporation. Use of the software indicates your acceptance of these terms. As used in this License Agreement, the term "Software" means the EasyRestore software included on the CD provided with this License Agreement.

1. **PROPRIETARY RIGHTS.** The Software is a proprietary product of PowerQuest Corporation ("PowerQuest") or its licensors and is protected under U.S. copyright laws and international treaty provisions. Ownership of the Software and all copies, modifications, and merged portions thereof shall at all times remain with PowerQuest or its licensors.
2. **GRANT OF LICENSE.** The Software is being licensed to you, which means you have the right to use the Software only in accordance with this License Agreement. The Software contains pre-installed software for disaster recovery purposes. The Software is only authorized for distribution together with a specific computer. This License authorizes you to use the Software for disaster recovery purposes only, to restore the hard disk image contained on the CD to the computer with which the CD and Software were originally shipped.
3. **NONPERMITTED USES.** Without the express permission of PowerQuest, you may not (a) use, copy, modify, alter, or transfer, electronically or otherwise, the Software or documentation except as expressly permitted in this License Agreement, or (b) translate, reverse program, disassemble, decompile, or otherwise reverse engineer the Software.
4. **TECHNICAL SUPPORT.** PowerQuest is NOT responsible to provide technical support. Any and all technical support questions, regarding the Software, should be referred to the place of purchase.
5. **U.S. GOVERNMENT RESTRICTED RIGHTS.** If you are acquiring the Software on behalf of any unit or agency of the United States Government, the following provision applies: It is acknowledged that the Software and the documentation were developed at private expense and that no part is in the public domain and that the Software and documentation are provided with RESTRICTED RIGHTS. Use, duplication, or disclosure by the Government is subject to restrictions as set forth in subparagraph (c)(1)(ii) of the Rights in Technical Data and Computer Software clause at DFARS 252.227-7013 or subparagraphs (c)(1) and (2) of



the Commercial Computer Software-Restricted Rights at 48 CFR 52.227-19, as applicable.
Contractor/manufacture is PowerQuest Corporation/P.O. Box 1911/Orem, UT 84059.

6. NO WARRANTY. The Software is being provided to you AS IS. PowerQuest does not warrant the Software to end users. If the Software fails to perform substantially in accordance with the documentation provided to your hardware supplier, PowerQuest will repair or replace the copy of the Software provided to your hardware supplier and will authorize your hardware supplier to provide such repaired or replaced Software to you without charge.

7. LIMITATION OF LIABILITY. NEITHER POWERQUEST NOR ITS SUPPLIERS SHALL IN ANY EVENT BE LIABLE FOR ANY DAMAGES WHATSOEVER ARISING OUT OF OR RELATED TO THE USE OF OR INABILITY TO USE THE SOFTWARE, INCLUDING BUT NOT LIMITED TO DIRECT, INDIRECT, SPECIAL, INCIDENTAL, OR CONSEQUENTIAL DAMAGES, AND DAMAGES FOR LOSS OF BUSINESS PROFITS, BUSINESS INTERRUPTION, LOSS OF BUSINESS INFORMATION, OR OTHER PECUNIARY LOSS, EVEN IF POWERQUEST CORPORATION HAS BEEN ADVISED OF THE POSSIBILITY OF SUCH DAMAGES, WHETHER SUCH LIABILITY IS BASED ON CONTRACT, TORT, WARRANTY, OR ANY OTHER LEGAL OR EQUITABLE GROUNDS. BECAUSE SOME STATES DO NOT ALLOW THE EXCLUSION OR LIMITATION OF LIABILITY FOR CONSEQUENTIAL OR INCIDENTAL DAMAGES, THE ABOVE LIMITATION MAY NOT APPLY TO YOU.

8. NO WAIVER. Any failure by either party to this agreement to enforce a specific part of the agreement in a specific situation is not a waiver of rights under the agreement. The party may still enforce the rest of the agreement in that situation and may still enforce some or all of the agreement in other situations.

9. This License Agreement constitutes the entire agreement between you and PowerQuest pertaining to its subject matter. This License Agreement is governed by the laws of the State of Utah. Any litigation arising from this license will be pursued only in the state or federal courts located in the State of Utah.

Copyright 1994-2004, PowerQuest Corporation. All rights reserved. U.S. Patents 5,675,769; 5,706,472; and 5,930,831; other patents pending in the U.S.A. and elsewhere. PowerQuest is a registered trademark and EasyRestore is a trademark of PowerQuest Corporation.



Appendixes



Preparation For Re-installation

You can format the hard disk and re- install the preinstalled software with the recovery CD-ROMs, and set the status of your computer to the same configuration as you used for the first time. The following items are necessary for re-installation:

- External CD-ROM drive unit
- Product Recovery CD-ROM disks
- Operation Manual



- *It takes about ten seconds for the system to recognize a CD-ROM. If you operate too quickly, an error message may appear. In this case, return to the first step and repeat the installation.*
- *Use the Product Recovery CD-ROMs only for your computer.*
- *The Product Recovery CD-ROMs are not for sale. Keep them in a secure place.*

Backing Up Data

Before formatting the hard disk, you should back up your data. For details on how to back up your data, refer to *Data Backup and Restore* section on A-6.

Selecting Way To Recover Your System

Your computer has two drives (C: and D:) when it was shipped from the factory. You can select the way to recover your system.

- *Recovers C: drive only. (Recommended)*
This process will format C: drive only and recover C: drive to the same status as shipped from the factory. Nothing will be performed to D: drive. The volume of the drives will not be changed and will keep current one.
- *Recovers both C: and D: drive.*
This process will format both C: and D: drives, and contents of the hard disk will be restored to its original state in C: drive. The volume of the drives will be back to the same as you used for the first time.



Formatting Drives and Re-installing Windows

1. Make sure the computer is turned off.
2. If any peripheral devices are connected to your computer, disconnect them except the external CD-ROM drive unit.
3. Connect the AC adapter; then, turn on the computer.



Be sure to connect the AC adapter. If the battery is completely discharged, the installation process will be canceled.

4. When the message *Press F2 for System Utilities* appears, press **F2**. The Setup Utility will open.
5. Insert the Product Recovery CD-ROM Disk1 into the CD-ROM drive.
6. In the *Exit* menu, select *Load Setup Defaults*; then, press **Enter** twice.
7. In *Boot Sequence* of the *Boot* menu, set *CD-ROM Drive* to the top of the list; then, press **ESC**.
8. In the *Exit* menu, confirm *Exit Saving Changes* is highlighted and press **Enter** twice.
9. Read the message on the screen, and select the way to recover your system; then, press **Enter**.
10. Read the message and select *Continue*; then, press **Enter**.



Although the pointer may be shown on the screen, never touch the keyboard or the mouse during recovery except when the message prompts you to. If you touch them, the re-installation will be canceled.

11. If you see the message asking you to insert the Product Recovery CD-ROM Disk2, remove the Disk1 and insert the Disk2; then, press **Enter**.
12. If you see the message asking you to insert the Product Recovery CD-ROM Disk3, remove the Disk2 and insert the Disk3; then, press **Enter**.
13. When the hard disk has been recovered successfully, the system will restart automatically. Remove the Product Recovery CD-ROM Disk3
14. When the message *Press F2 for System Utilities* appears, press **F2**. The Setup Utility will open.
15. In the *Exit* menu, select *Load Setup Defaults*; then, press **Enter** twice.



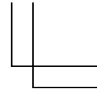

16. Set back the appropriate value for each Setup setting.
17. In the *Exit* menu, confirm *Exit Saving Changes* is highlighted and press **Enter** twice. The system will restart.
18. Set up Windows, following the instructions on the screen. When you finish the Setup, the recovery is completed. Be sure to set date and time.

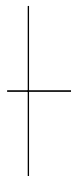
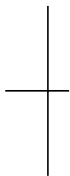

Appendixes

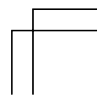
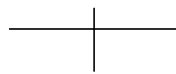

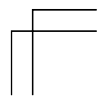
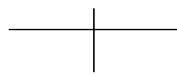
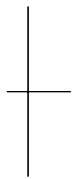
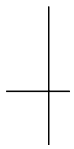
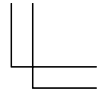



Troubleshooting

This chapter describes how to troubleshoot computer problems.

Common Problems

Problems with your computer can be caused by something as minor as an unplugged power cord or as major as a damaged hard disk drive. The information in this troubleshooting section is designed to help you find and solve minor problems. If you still have a problem after trying all the suggested remedies in this chapter, contact your dealer.

The problems that you might encounter can be divided into two basic categories: hardware and software. Hardware problems can be further divided into being of an electrical or a mechanical nature. You will know you have a hardware problem if, for example, the screen is blank, or your computer cannot recognize the disk drives.

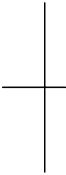

Software problems can occur at several levels. Both your operating system and your software application programs are capable of generating errors and error messages. If you encounter a software error, try to determine if the error message is from your operating system or from an application program, and refer to the appropriate manual for possible remedies.



You can also refer to the Windows manual or Windows help program to solve the problem. To access the help program, click *start –Help and Support*. It also gives you troubleshooting tips and an index.

Successful troubleshooting is the result of careful observation, deductive reasoning, and an organized approach to solving the problem. If you encounter a problem, begin by performing a careful visual inspection. Check the exterior of your computer first. If no lights are lit, check the battery charge or power outlet, the plug and power cord, and any power switches that may affect your computer. If your computer has been connected to any peripheral devices, look for loose or disconnected cables. You may also need to check the fuses and breakers in your electric box. A few common problems and suggested solutions are presented in the examples that follow.

Troubleshooting



Trouble when Starting



Why doesn't the power indicator or the battery indicator turn on?

- Make sure the AC adapter is correctly connected to the AC adapter jack of your computer.
- Make sure the AC power cable is correctly connected to a live wall outlet. Connect another electric equipment to the wall outlet and check whether it is live or not.
- Make sure the battery pack is correctly installed and charged.
- If the battery pack is discharged, connect the AC adapter.

Why do I get the message *Invalid system disk*?

- You may have inserted a non-bootable disk (either a defective disk or one without an operating system) in the optional external floppy disk drive unit. Remove the disk and press any key.

Why can't I boot from the floppy disk?

- 
- 
- Make sure that the optional external floppy disk drive unit is correctly connected to your computer.
 - Check whether the floppy disk set to the optional external floppy disk drive unit contains a system disk.
 - Check whether *Floppy Disk Drive* is set to the first in *Boot Sequence* and *USB Boot* is set to *Enabled* in *Boot* menu of the Setup Utility.

Why do I get the message *Press<F1> to resume, <F2> to setup*?

- The setting of the Setup Utility is deleted. Run the Setup Utility and get default value of the Setup Utility. Be sure to set the date and time correctly.

Why do I get the message *Operating system not found*?

- Run the Setup Utility and get default value of the Setup Utility. Be sure to set the date and time correctly.



Trouble with Display

See the *Display* section of Chapter 2 and 4.

Why is the screen blank?

- Press any key to see if any power management feature has turned off the screen to save power.
- See the power indicator to check whether your computer is turned on.
- If you are using a battery pack, make sure it is correctly installed and has a charge remaining.
- Make sure the LCD screen is selected as the display by pressing **Fn+F5**.
- Check whether the display is on by pressing **Fn+F11**.
- If you still have the problem after trying the above, follow the steps in *Why doesn't the keyboard or the glide pad function?*



Why does the external monitor display nothing or the image on it distorted?



- Confirm the monitor is turned on.
- Confirm the monitor is connected correctly.
- Make sure an external monitor is selected as the output display by pressing **Fn+F5**.
- If you use **Fn+F5** to change the display, the image may be distorted. Press **Fn+F5** again to return the previous display and use *Display Properties* dialog box to change it again. (Refer to Chapter 4.)
- Make sure the value of the *Screen resolution* in the *Settings* tab of the *Display Properties* is lower than the resolution of the external monitor.
- Make sure the external monitor is not near any electric devices having strong magnetic fields such as a TV set or radio.
- Do not share an outlet with a TV set or radio.

Why can't I change the display with Fn+F5 keys?

- When playing the animation or game, **Fn+F5** key combination may not work. Close the current running application.
- Use *Display Properties* dialog box to change it. (Refer to Chapter 4.)

- When you select *Resolution Expansion* mode, **Fn+F5** key combination does not work.

Why is the screen blank in a moment?

- When you connect/disconnect the AC adapter, your computer, with the POWERPLAY function enabled, controls the power supply. The control causes the screen to be blank. This is not a problem. (The POWERPLAY function can be set on *Advanced* tab in *Display Properties*.)

Trouble with Keyboard/Glide Pad

Why doesn't the keyboard or the glide pad function?

- Try the following in this order:
 1. Press **Ctrl+Alt+Delete** and select *Users* tab of *Windows Task Manager* dialog box. Click *Disconnect* or *Logoff*; then, *Yes*.
 2. If the step 1 fails to work, press the power switch for more than four seconds to turn off the system. Ten seconds later, turn on your computer.
 3. If you still cannot turn off the system with the power switch, confirm the hard disk indicator is not lit and press the reset switch on the bottom of your computer to turn off the system (refer to *Resetting the System* section of Chapter 2). Ten seconds later, turn on your computer by pressing the power switch.

Why does the glide pad malfunction?

- The surface of the glide pad or your palm may be moist or dirty and grease. Wipe the glide pad with a soft, dry cloth
- See the pad icon on the taskbar. When it is crossed (), remove the connected USB mouse. (Refer to *Enabling Glide Pad* section of Chapter 2.)
- Confirm *Internal Pointing Device* is enabled in *Advanced* menu of the Setup Utility.

Trouble with Floppy Disks

Why can't I use a floppy disk?

- Confirm the optional external floppy disk drive unit is correctly connected.
- Confirm the floppy disk is inserted correctly.
- Confirm the drive or file name is correct.
- The floppy disk may not be formatted or could be corrupted. Format the disk or use another disk.
- If you cannot write to a floppy disk, the disk may be write-protected. Eject the disk and ensure that the write-protect tab covers the small hole.
- If you cannot write to a floppy disk, the disk may be full. Use another disk.

Trouble with Hard Disk

Why can't I read or write data to/from the hard disk?

- Confirm the drive and file names are correct.
- Confirm the hard disk has sufficient free space.

Trouble with CD



Why can't I read data from a compact disc or play files?

- Confirm the external CD-ROM drive unit is correctly connected to your computer.
- Confirm the CD is inserted correctly.
- Confirm the drive and file names are correct.
- Confirm the CD is not stained or scratched.
- Confirm the CD or files are supported.

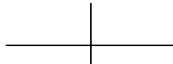

Trouble with Communication

Why can't I communicate through the modem?

- Confirm the modem card is properly inserted in your computer.
- Confirm the dial setting (pulse or tone) of Windows or communication software is matched with the telephone line.
- Confirm the country/region setting is appropriate.

- 
- 
- 
- Confirm the network configuration is appropriate.
 - Confirm the user name or password is correct.
 - Confirm the COM port in the communication software is set appropriately.
 - Turn off the power management in the Windows.
 - If an unusual device is attached to the line you are connecting to, the modem may not function properly. Remove the device or contact a dealer of the device.
 - If connected to a PBX, consult the PBX maintenance staff or its service company. If the electric characteristics of your PBX are different from those of a regular analog line, the modem will not function properly. If you connect the modem to a digital PBX, both the modem and the PBX may be damaged.

Why can't I access the LAN?

- 
- 
- Confirm the cable is properly connected to the LAN jack and the network hub.
 - Confirm the network configuration is appropriate.
 - Confirm the LAN driver is enabled in *System Properties* dialog box. Click *Hardware* tab, then, *Device Manager*. Double-click *Network adapters*, then, *Realtek RTL8139xxxx*, and confirm *Use this device (enable)* is selected in *Device Usage* field of *General* tab.
 - Confirm the user name or password is correct.

How can I detect the MAC address?

- 
- Follow the instructions below:
 1. Click *start – All Programs – Accessories – Command Prompt*.
 2. Type `ipconfig/all`; then, press **Enter**. The IP information appears.
 3. For the LAN, see the numbers of *Physical Address* in *Ethernet adapter Local Area Connection* section. For the Wireless LAN, see the numbers of *Physical Address* in *Ethernet adapter Wireless Network Connection* section.
 4. Type `exit`; then, press **Enter**.

Why can't I detect the access point on my computer? (for wireless LAN communication)

- Confirm the access point is powered on.
- Confirm the wireless LAN antenna is enabled. When the antenna indicator lights green, the antenna is enabled. If not, press **Fn+F1** keys.
- Restart your computer.
- Detect the access point by following the steps below:
 1. Click *start – My Computer*.
 2. Select *My Network Places* in *Other Places* field; then, *View network connections* in *Network Tasks* field. *Network Connections* dialog box appears.
 3. Right-click *Wireless Network Connection*; then, click *Disable*.
 4. Right-click *Wireless Network Connection*; then, click *Enable*.
- When you have more than one available access points, your computer may be connected to the access point other than the one you want to access:
 1. Right-click *Wireless Network Connection* icon (📶) on the taskbar; then, click *View Available Wireless Networks*.
 2. Select the desired network in the *Available wireless networks* list; then, connect to the network. (Refer to *Connecting to Internet via an Access Point* section of Chapter 5.)

Why can't I connect to the network via an access point? (for wireless LAN communication)

- Confirm the wireless LAN antenna is enabled. When the antenna indicator lights green, the antenna is enabled. If not, press **Fn+F1** keys.
- Confirm *Any available network (access point preferred)* is selected in *Networks to access* of *Advanced* dialog box. (To open *Advanced* dialog box, refer to *Communicating with Other Computers* section of *Wireless LAN* of Chapter 5.)
- Confirm the ESSID of your computer matches the ESSID of the access point you want communicate with.
- Confirm the *Network key* is correctly entered if the WEP security of the access point is enabled.
- You may accidentally enable IEEE802.1x authentication. Uncheck the box of *Enable IEEE802.1x authentication for this network* when you connect the network

in *Wireless Network Connection* dialog box. (Refer to *WEP (Wired Equivalent Privacy) Encryption* of Chapter 5.)

Why can't I communicate with other computers through a wireless LAN?

- Confirm the wireless LAN antenna is enabled. When the antenna indicator lights green, the antennas are enabled. If not, press **Fn+F1** keys.
- Confirm each computer is enabled for wireless LAN.
- Confirm *Computer-to-computer (ad hoc) networks only* is selected in *Networks to Access of Advanced* dialog box of each computer. (To open *Advanced* dialog box, refer to *Communicating with Other Computers* section of *Wireless LAN* of Chapter 5.)
- Adjust the distance between your computers by bringing your computer closer to others and remove any obstructions that may impede the communication; then, try to connect again. (The distance between computers or access points should be less than approximately 190 ft. (60 m) in the direct line-of-sight.)
- Confirm the IP address and the subnet mask of each computer are set correctly.
- Confirm the WEP key is correctly entered if the WEP security of other devices, which you want to communicate with, is enabled.

Why is the communication speed so slow even between computers supporting IEEE802.11g?

- Change the value of the communication settings by following the instructions below.
 1. Click *start – Control Panel*.
 2. Click *Network and Internet Connections*.
 3. Click *Internet Connections*.
 4. In *Network Connections* widow, right-click *Wireless Network Connection* and click *Properties*.
 5. In *General* tab, click *Configure...*
 6. Click *Advanced* tab and select *Configuration Profile* in the *Property* field.
 7. Select *Auto (11G&11B) Long* in the *Value* field.
 8. Click *OK* and then, close the window.

Trouble with Peripherals

Why don't peripheral devices function correctly?

- Confirm they are correctly connected to your computer.
- Confirm they are Windows XP compliant.
- Confirm drivers necessary for the devices are installed.
- Set *System standby* and *System hibernates* to *Never* in *Power Options Properties* dialog box. If this does not work, set *Turn off hard disks* to *Never*.

Why can't I print?

- Make sure the printer is turned on.
- Check whether your computer and the printer are connected correctly.
- Check whether the printer is ready to print.
- Check whether the printer has enough paper.
- Check whether the printer driver is installed.
- From the *start* menu, select *Control Panel – Printers and Other Hardware - Printers and Faxes*. If Classic view is selected, double-click *Printers and Faxes* icon. Confirm your printer is installed there. If not, click *Add a printer* or *Printer Tasks* to install your printer.
- See also the Windows help program by clicking *start – Help and Support*.



Trouble with Connection Cradle

Why doesn't the battery indicator on the MM series inserted in the connection cradle turn on?

- Make sure the AC adapter is correctly connected to the AC adapter jack of the connection cradle.
- Make sure the AC power cable is correctly connected to a live wall outlet. Connect another electric equipment to the wall outlet and check whether it is live or not.
- Make sure the battery pack is correctly installed in the MM series.
- Make sure the MM series is correctly inserted in the connection cradle.

Why do I get the message *Invalid system disk*?

- You may have inserted a non-bootable disk (either a defective disk or one without an operating system) in the optional external floppy disk drive unit. Remove the disk and press any key.



Why can't I insert the MM series into the connection cradle?

- Make sure that you insert the MM series into the connection cradle properly.
- Make sure that the host PC connection switch on the connection cradle is in the *ON* position.

Why isn't the MM series recognized as an external hard disk of the host computer?



Troubleshooting

- Make sure you insert the MM series into the connection cradle properly.
- Make sure that the USB cable is correctly connected to the connection cradle and the host computer.
- Make sure that the MM series in the connection cradle is powered off. The MM series is not recognized when it is powered on, in the system standby or system hibernate mode. Be sure to turn off the MM series before setting it into the connection cradle.
- Once you stop the device on the host computer with the MM series in the connection cradle, it is not recognized as an external hard disk. Slide the host PC connection switch once to *OFF*, then back again to *ON*.

- Make sure that the operating system of the host computer is Windows XP, Windows 2000, or Windows Me.
- Slide the connection switch to *OFF* and then back to *ON*. You may not have stopped the connection properly.

Why is the MM series recognized as removable disk, or why can't I access to the MM series from the host PC?

- You cannot access to the MM series from the host PC when you set a user password in the Setup Utility of the MM series. Cancel the password using the *Password Utility*. (Refer to *Canceling Password* section of Chapter 7.)
- If you remove the MM series from the connection cradle without canceling the password and then delete the password using the Setup Utility, the MM series may be recognized as removable disks of the host computer when connected once again. In this case, run the *Password Utility* on the host computer and restart the host computer.

**Why is the data transfer from the MM series to the host PC so slowly?
Or why can't I use the data transfer speed of USB2.0?**

- Make sure that the host PC supports USB 2.0.
- Make sure that the host computer and the connection cradle is connected using the supplied DirectHD cable.

Why can't I cancel the password?

- Make sure that the MM series is correctly inserted in the connection cradle.

Other Troubles

Why is the battery pack discharged so quickly?

- Condition the battery pack. (Refer to *Conditioning the Battery Pack* section of Chapter 3.)

Why is the date and/or time incorrect?

- Correct the date and time in Windows. Double-click the time appearing on the taskbar and set them in *Date and Time Properties* dialog box.

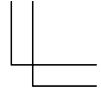
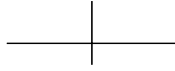

Why can't I use a hardware device?

- Make sure the hardware device is not crossed out with an X mark using the following procedure.
 1. Click *start– Control Panel*.
 2. Click *Performance and Maintenance*; then, *System*. If Classic view is selected, double-click *System* icon.
 3. Click *Hardware* tab; then, *Device Manager*.
 4. Double-click the device you cannot use.
 5. Confirm *Use this device (enable)* string is selected in *Device usage* field.

Why can't I produce sound?

- Press **Fn + F4** to increase the output volume.
- Double-click the speaker symbol on the taskbar and check the Windows volume.

Why can't I turn off my computer?

- Follow the instructions on *Why doesn't the keyboard or the glide pad function?* section.

Why my computer is so hot?

- When charging the battery pack, its surrounding area or the front of the keyboard may become hot, but this is not a problem.

Why can't find the drivers and applications?

- You may accidentally remove them. They are stored on the last recovery disk. (i.e. when two recovery CDs are provided, they are stored on the “Disk 2”.) When you are not sure how to install them or the CD does not have the drivers or applications, consult local service staff.

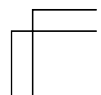

Index

A

- AC adapter
 - connecting, 1-4
 - using, 2-2
- Account
 - creating, 2-12
 - switching, 2-12
- Antenna, 5-4
- Audio
 - controlling output volume, 2-6

B

- Back up data, A-5
- Battery pack
 - changing, 3-5
 - charging, 3-2
 - checking level, 3-2
 - conditioning, 3-4
 - indicator, 2-1 3-3
 - low battery indication, 3-3

C

- Cleaning
 - computer, A-1
- CD
 - handling, 4-8
 - inserting, 4-8
 - playing, 4-10
 - removing, 4-9
 - troubleshooting, T-5
- CD-ROM drive (external)
 - connecting, 4-7
 - cleaning, 4-10
 - mode switch, 4-10
 - disconnecting, 4-10
- Connection Cradle
 - charging battery, 7-4
 - connecting to host computer, 7-6
 - overview, 7-3

- password, 7-18
- precautions, 7-1
- removing, 7-17
- stopping connection, 7-15
- using as external hard disk, 7-6
- Synchronizing, 7-11
- troubleshooting, T-10

D

- Display
 - changing brightness, 2-10
 - changing resolution, 2-10
 - changing number of colors, 2-10
 - switching the display, 2-7
 - troubleshooting, T-3
 - turning off, 2-7

E

- External monitor
 - connecting, 4-11
 - disconnecting, 4-13
 - switching the display, 2-6, 4-13

F

- Floppy disk
 - ejecting, 4-4
 - handling, 4-3
 - inserting, 4-4
 - formatting, 4-5
 - troubleshooting, T-4
- Floppy disk drive (external)
 - connecting, 4-3
 - removing, 4-5
 - troubleshooting, T-4

Index



G

Glide pad
 changing configuration, 2-6
 clicking and double-clicking, 2-5
 drag and drop, 2-5
 scroll, 2-5
 troubleshooting, T-4

H

Hard disk drive
 troubleshooting, T-5

I

Indicators
 antenna, 5-4
 power, 1-5, 2-1
 battery status, 2-1, 3-3
 status, xv

K

Keyboard
 Application key, 2-7
 function keys, 2-7
 special keys, 2-7
 troubleshooting, T-4
 windows key, 2-7

L

LAN
 configuring, 5-3
 connecting to wired network, 5-2
 removing LAN cable, 5-4
 troubleshooting, T-6

M

Mobile Mode Switch
 Mobile Mode, 3-12
 Normal Mode, 3-12
 Modem card
 Installing, 5-14
 Removing, 5-15

Index-2

N

Network Setup Utility
 changing, 5-13
 deleting, 5-13
 loading, 5-12
 switching, 5-12

P

Passwords
 changing, 2-13, 6-5
 deleting, 2-14, 6-5
 setting, 2-13, 6-5
 PC cards
 ejecting, 4-19
 inserting, 4-18
 Peripherals
 audio equipment, 4-15
 connecting guidelines, 4-1
 external monitor, 4-11
 headphones, 4-16
 PC cards, 4-18
 printer, 4-21
 troubleshooting, T-9
 USB device, 4-17
 Power
 button, 1-5
 choosing AC or battery, 2-1
 indicator, 1-5, 2-1
 Power management
 disabling, 3-11
 stopping power supply to display, 3-8
 stopping power supply to hard disk, 3-8
 system hibernate, 3-9
 system standby, 3-9
 Printer, 4-21

R

Resetting
 power switch, 2-3

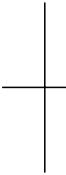

Index



reset switch, 2-3
Restore data, A-5
Re-installation, A-7

S

Screen Saver, 2-11
Setup utility
 advanced menu, 6-4
 boot menu, 6-6
 Changing setting, 6-2
 entering and exiting, 6-2
 exit menu, 6-6
 main menu, 6-3
 running, 6-1
 security menu, 6-4
System standby
 about, 3-9
 generating conditions, 3-10
 resuming from, 3-9
System hibernate
 about, 3-9
 generating conditions, 3-10
 resuming from, 3-9
 supporting, 3-10
Status indicators, xv

T

Troubleshooting
 common problems, T-1
 communications, T-5
 CD, T-5
 Connection Cradle, T-10
 display, T-3
 floppy disk drive, T-4
 hard disk drive, T-5
 keyboard or glide pad, T-4
 peripherals, T-8
 wired LAN, T-6
 wireless LAN, T-6

U

USB device, 4-17

V

Virus protection, A-3

W

Wallpaper, 2-11
Wireless LAN
 activating antenna, 2-7, 5-5
 communicating, 5-9
 confirming status, 5-9
 connecting to WEP network, 5-7
 connecting to access point, 5-7
 troubleshooting, T-6

