

BARCO

BARCO PROJECTION SYSTEMS

BARCO **VISION**
701 MULTIMEDIA

R9000740

OWNER'S MANUAL

Date:
070597

Rev. :
01

Art. No.
R5975238

Due to constant research, the information in this manual is subject to change without notice.

Produced by BARCO NV, May 1997.
All rights reserved.

Trademarks are the rights of their respective owners.

Printed in Belgium

TABLE OF CONTENTS

WARNINGS	1-1
SAFETY INSTRUCTIONS	1-1
On safety	1-4
On installation	1-5
On servicing	1-6
On cleaning	1-6
On repacking	1-7
On illumination	1-7
LOCATION AND FUNCTION OF CONTROLS	2-1
Rear panel terminology	2-2
Front panel terminology	2-3
Control panel terminology	2-4
a. The local keypad	2-4
b. RCU control panel terminology	2-4
POWER (MAINS) CONNECTION	3-1
Switching on/off	3-2
Power (mains) cord connection	3-2
SOURCE CONNECTIONS	4-1
Signal input connection to the projector :	4-2
Connecting a Composite Video source.	4-3
Connecting a S-Video source.	4-4
Connecting a RGB Analog source with composite sync.	4-5
Connecting a RGB Analog source with Tri-level sync.	4-7
Connecting a Component source.	4-8
Connecting a Component source with Tri-level sync.	4-9
Connecting a computer, e.g. IBM PC (or compatible), Apple Macintosh to the RS232 input of the projector.	4-11
Connecting a RCVDS 05 switcher to the projector.	4-12
Connecting a VS05 switcher to the projector.	4-12
Connecting an IR Remote Receiver to the projector	4-12
Peripheral equipment	4-12
CONTROLLING	5-1
Battery installation in the RCU.	5-2
How to use your RCU	5-3
Projector address	5-5
How to display a projector address?	5-5
How to program an address into the RCU?	5-6
Input selection	5-6
Picture controls	5-8
The Pause key.	5-11
START UP OF THE ADJUSTMENT MODE	6-1
Entering the adjustment mode	6-2
Adjustment mode	6-3

TABLE OF CONTENTS

GUIDED ADJUSTMENT MODE	7-1
Start up of the guided adjustment mode.	7-2
Overview flowchart 'Guided Adjustment' procedure.	7-3
Selecting Setup Pattern	7-4
Internal Cross Hatch Pattern	7-5
Picture tuning	7-6
Sync Fast/Slow toggle	7-6
Line Doubler (option)	7-6
Enhanced blue ON/OFF	7-7
Raster Centering on Green CRT Faceplate	7-8
Shifting Red and Blue on Green	7-10
Left-Right (East-West) Adjustments	7-10
Vertical Centerline Bow Adjustment	7-11
Vertical Centerline Skew Adjustment	7-11
Right Keystone Adjustment	7-12
Left Keystone Adjustment	7-12
Right Bow Adjustment	7-12
Left Bow Adjustment	7-13
Horizontal Size Adjustment	7-13
Top-Bottom (North-South) Adjustments	7-14
Horizontal Centerline Skew Adjustment	7-15
Horizontal Centerline Bow Adjustment	7-15
Top Keystone Adjustment	7-15
Top Bow Adjustment	7-16
Bottom Keystone Adjustment	7-16
Bottom Bow Adjustment	7-16
Size-linearity Adjustment	7-17
Vertical Linearity Adjustment	7-17
Vertical Size Adjustment	7-18
Horizontal Phase Adjustment	7-19
Convergence Adjustment	7-20
Blanking Adjustment	7-21
Top blanking adjustment	7-22
Bottom blanking adjustment	7-22
Left blanking adjustment	7-23
Right blanking adjustment	7-23
Color Balance	7-24
RANDOM ACCESS ADJUSTMENT MODE	8-1
Starting up the random access adjustment mode.	8-2
Overview flowchart 'Random Access Adjustment' mode	8-3
Selecting Setup Pattern	8-5
Internal Cross Hatch Pattern	8-6
Random Access Adjustment Mode Selection menu.	8-6
Picture tuning	8-7
Color Balance	8-7
Sync Fast/Slow Adjustment	8-8
Line doubler	8-9
Enhanced Blue On/Off Adjustment	8-9
Color Select	8-10

TABLE OF CONTENTS

Geometry Adjustments	8-11
Horizontal Phase Adjustment	8-12
Raster Shift Adjustment	8-14
Left-Right (east-west) Adjustments	8-16
Top-Bottom (north-south) Adjustments	8-18
Horizontal Size Adjustment	8-20
Vertical Linearity Adjustment	8-21
Vertical Size Adjustment	8-22
Blanking Adjustments	8-23
Convergence Adjustments	8-25
SERVICE MODE	9-1
Starting up the Service mode.	9-2
Overview flowchart 'Service' mode.	9-3
Projector set up	9-4
Identification	9-4
Total run time	9-5
Change password	9-6
Change language	9-7
Change projector address	9-8
Change baudrate	9-8
Power up mode	9-9
BARCO logo	9-10
Memory management	9-11
Copy a block	9-11
Deletion of blocks	9-12
Deleting block by block	9-13
Deletion of all blocks	9-14
All settings to midposition	9-14
Undo all settings to midpos	9-15
R & B convergence mid	9-15
Undo R & B convergence mid	9-16
Switch green convergence off	9-16
Switch green convergence on	9-17
Common settings	9-17
G2 adjustment	9-18
CRT run in cycle	9-19
Projector warm up	9-20
I2C Diagnostics	9-21
MESSAGES, WARNINGS AND FAILURES	10-1
OPTIONS	11-1
IR Receiver 800	11-2
Hardwired RCU	11-2
Projector Control software	11-3
RCVDS 05	11-3
VS05	11-3
Adapter and communication cables	11-3
Ceiling mount CM50	11-4

TABLE OF CONTENTS

Orbiting Kit	11-4
Soft edge matching kit	11-4
Contrast modulation kit	11-4
Appendix A : Battery replacement in the RCU.	A-1
Appendix B : Orbiting	B-1
Appendix C : Soft edge matching	C-1
Appendix D : Contrast modulation (option)	D-1
Appendix E : Adjustment Blocks (memory blocks)	E-1
Appendix F : Source numbers 90 - 99	F-1

WARNINGS

SAFETY INSTRUCTIONS

- on safety**
- on installation**
- on servicing**
- on cleaning**
- on repacking**
- on illumination**

Notice on Safety

This equipment is built in accordance with the requirements of the international safety standards EN60950, UL 1950 and CSA C22.2 No.950, which are the safety standards of information technology equipment including electrical business equipment.

These safety standards impose important requirements on the use of safety critical components, materials and isolation, in order to protect the user or operator against risk of electric shock and energy hazard, and having access to live parts.

Safety standards also impose limits to the internal and external temperature rises, radiation levels, mechanical stability and strength, enclosure construction and protection against the risk of fire.

Simulated single fault condition testing ensures the safety of the equipment to the user even when the equipment's normal operation fails.

INSTALLATION INSTRUCTIONS

Before operating this equipment please read this manual thoroughly, and retain it for future reference.

Installation and preliminary adjustments should be performed by qualified BARCO personnel or by authorized BARCO service dealers.

OWNER'S RECORD

The part number and serial number are located at the left side of the projector. Record these numbers in the spaces provided below. Refer to them whenever you call upon your BARCO dealer regarding this product.

PART NUMBER :

SER. NUMBER :

DEALER :

SAFETY INSTRUCTIONS

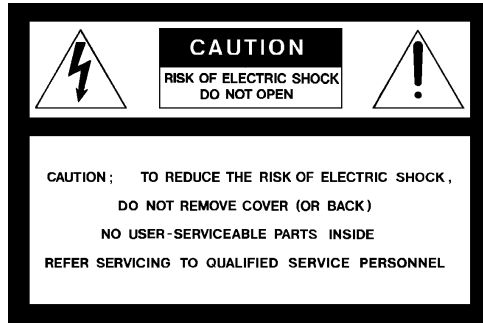

The lightning flash with an arrowhead within a triangle is intended to tell the user that parts inside this product may cause a risk of electrical shock to persons.



The exclamation point within a triangle is intended to tell the user that important operating and/or servicing instructions are included in the technical documentation for this equipment.

WARNING
TO PREVENT FIRE OR ELECTRICAL SHOCK HAZARD, DO NOT EXPOSE THIS EQUIPMENT TO RAIN OR MOISTURE

FEDERAL COMMUNICATION COMMISSION (FCC STATEMENT)

This equipment has been tested and found to comply with the limits of a class A digital device, pursuant to Part 15 of the FCC Rules. These limits are designed to provide reasonable protection against harmful interference when the equipment is operated in a commercial environment. This equipment generates, uses and can radiate radio frequency energy and, if not installed and used in accordance with the instruction manual, may cause harmful interference to radio communications. Operation of this equipment in a residential area is likely to cause harmful interference in which case the user will be required to correct the interference at his own expense.

- * All the safety and operating instructions should be read before using this unit.
- * The safety and operating instructions manual should be retained for future reference.
- * All warnings on the equipment and in the documentation manuals should be adhered to.
- * All instructions for operating and use of this equipment must be followed precisely.

On safety

1. This product should be operated from an AC power source

Operating AC power voltage of the projector:

BARCOVISION 701 MULTIMEDIA
Art.No. R9000740 (230V AC)

The projector leaves the factory for 230 Vac. Consult your dealer to switch over to 120 Vac.

If you are not sure of the type of AC power available, consult your dealer or local power company.

2. This product is equipped with a 3-wire grounding plug, a plug having a third (grounding) pin. This plug will only fit into a grounding-type power outlet. This is a safety feature. If you are unable to insert the plug into the outlet, contact your electrician to replace your obsolete outlet. Do not defeat the purpose of the grounding-type plug.

WARNING FOR THE CUSTOMERS: THIS APPARATUS MUST BE GROUNDED (EARTHED) via the supplied 3 conductor AC power cable.
(If the supplied power cable is not the correct one, consult your dealer.)

A. Mains lead (Power cord) with CEE 7 plug:

The wires of the mains lead are colored in accordance with the following code.

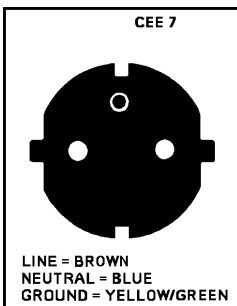

Green and yellow: earth (safety earth)
Blue: neutral
Brown: line (live)

SAFETY INSTRUCTIONS

B. Power cord with ANSI 73.11 plug:

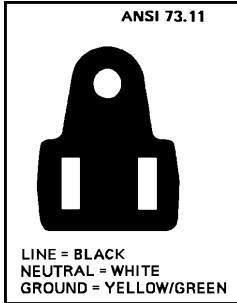

The wires of the power cord are colored in accordance with the following code.

Green/yellow: ground
White: neutral
Black: line (live)

3. Do not allow anything to rest on the power cord. Do not locate this product where persons will walk on the cord.

To disconnect the cord, pull it out by the plug. Never pull the cord itself.

4. If an extension cord is used with this product, make sure that the total of the ampere ratings on the products plugged into the extension cord does not exceed the extension cord ampere rating. Also make sure that the total of all products plugged into the wall outlet does not exceed 15 amperes.

5. Never push objects of any kind into this product through cabinet slots as they may touch dangerous voltage points or short out parts that could result in a risk of fire or electrical shock.

Never spill liquid of any kind on the product. Should any liquid or solid object fall into the cabinet, unplug the set and have it checked by qualified service personnel before resuming operations.

6. Lightning - For added protection for this video product during a lightning storm, or when it is left unattended and unused for long periods of time, unplug it from the wall outlet. This will prevent damage to the projector due to lightning and AC power-line surges.

On installation

1. Do not place this equipment on an unstable cart, stand, or table. The product may fall, causing serious damage to it.

2. Do not use this equipment near water.

3. Slots and openings in the cabinet and the back or bottom are provided for ventilation; to ensure reliable operation of the product and to protect it from overheating, these openings must not be blocked or covered. The openings should never be blocked by placing the product on a bed, sofa, rug, or other similar surface.

This product should never be placed near or over a radiator or heat register. The projector should not be placed in a built-in installation or enclosure unless proper ventilation is provided.

On servicing

Do not attempt to service this product yourself, as opening or removing covers may expose you to dangerous voltage potentials and risk of electric shock!

Refer all servicing to qualified service personnel.

Unplug this product from the wall outlet and refer servicing to qualified service personnel under the following conditions:

- a. When the power cord or plug is damaged or frayed.
- b. If liquid has been spilled into the equipment.
- c. If the product has been exposed to rain or water.
- d. If the product does not operate normally when the operating instructions are followed.
Note : Adjust only those controls that are covered by the operating instructions since improper adjustment of the other controls may result in damage and will often require extensive work by a qualified technician to restore the product to normal operation.
- e. If the product has been dropped or the cabinet has been damaged.
- f. If the product exhibits a distinct change in performance, indicating a need for service.

Replacement parts - When replacement parts are required, be sure the service technician has used original BARCO replacement parts or authorized replacement parts which have the same characteristics as the BARCO original part. Unauthorized substitutions may result in degraded performance and reliability, fire, electric shock or other hazards. Unauthorized substitutions may void warranty.

Safety check - Upon completion of any service or repairs to this projector, ask the service technician to perform safety checks to determine that the product is in proper operating condition.

On cleaning

Unplug this product from the wall outlet before cleaning. Do not use liquid cleaners or aerosol cleaners. Use a damp cloth for cleaning.

- To keep the cabinet looking brand-new, periodically clean it with a soft cloth. Stubborn stains may be removed with a cloth lightly dampened with mild detergent solution. Never use strong solvents, such as thinner or benzine, or abrasive cleaners, since these will damage the cabinet.

SAFETY INSTRUCTIONS

- To ensure the highest optical performance and resolution, the projection lenses are specially treated with an anti-reflective coating, therefore, avoid touching the lens. To remove dust on the lens, use a soft dry cloth. Do not use a damp cloth, detergent solution, or thinner.

On repacking

Save the original shipping carton and packing material; they will come in handy if you ever have to ship your equipment. For maximum protection, repack your set as it was originally packed at the factory.

On illumination

In order to obtain the best quality for the projected image, it is essential that the ambient light which is allowed to fall on the screen be kept to an absolute minimum.

When installing the projector and screen, care must be taken to avoid exposure to ambient light directly on the screen. Avoid adverse illumination on the screen from direct sunlight or fluorescent lighting fixtures.

The use of controlled ambient lighting, such as incandescent spot light or a dimmer, is recommended for proper room illumination. Where possible, care should also be taken to ensure that the floors and walls of the room in which the projector is to be installed are non-reflecting, dark surfaces. Brighter surfaces will tend to reflect and diffuse the ambient light and hence reduce the contrast of the projected image on the screen.

LOCATION AND FUNCTION OF CONTROLS

Rear Panel Terminology

Front Panel Terminology

RCU Terminology

REAR PANEL TERMINOLOGY

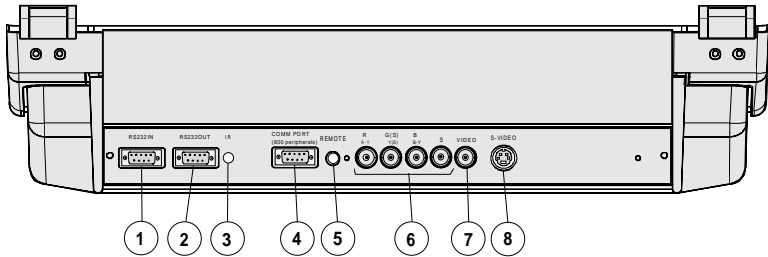

1 RS232IN
 Connection between the BARCOVISION 701 MULTIMEDIA and an IBM PC (or compatible) or MAC (RS422) for remote computer control and data communication.

2 RS232OUT
 Used to connect to the next projector, RS232IN plug (communication link for PC or MAC to the next projector)

3 IR sensor
 receiver for control signals transmitted from the RCU.

4 Communication port (800 peripherals)
 * allows communication between the RCVDS switcher and the projector.
 * allows connection of a remote IR receiver unit to the projector.
 * allows connection of an IRIS 800 to converge the image automatically.

5 IR Remote
 remote input for wired remote control

6 RGB-S IN or (R-Y)Y(B-Y)-S IN (4x BNC connector):
RGB-S in : allows a character generator, microcomputer, video camera, etc. having analog RGB output to be connected to the projector.

Line inputs: - signals RED-GREEN-BLUE
 - COMPOSITE sync. signal

(R-Y)Y(B-Y)-S IN (component in):allows to connect e.g. a professional VCR having component outputs to the projector.

Line inputs - signals RED-LUMA, LUMA, BLUE-LUMA
 - COMPOSITE sync. signal

LOCATION AND FUNCTION OF CONTROLS

- 7** **VIDEO IN (Composite video, 1x BNC connector):** allows a video tape recorder, video camera, color receiver/monitor, etc. having video line output to be connected to the projector.
- 8** **S-VIDEO IN:** Separated Y/C (luma-chroma) signal inputs and outputs for higher quality playback of Super VHS signals (4-pin S-VIDEO connector).

FRONT PANEL TERMINOLOGY

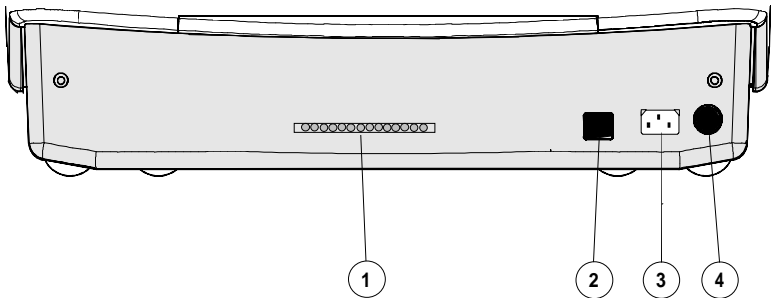

- 1** **AUTODIAGNOSIS DISPLAY**
LED indication for service purposes.

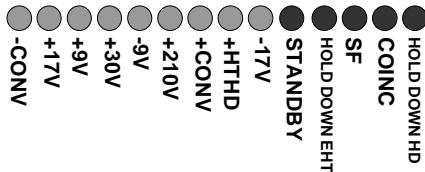

- 2** **POWER (MAINS) SWITCH :** press the switch to turn the projector ON.
Depending on the hardware set-up of the projector during installation, the projector switches to '**standby**' or to '**operational mode**'. If in standby, the standby led in the autodiagnosisdisplay lights up.
- 3** **POWER (MAINS) INPUT:** Connect the supplied ac power (mains) cord here and to wall the outlet.
- 4** **IR SENSOR**
receiver for control signals transmitted from the RCU700.

Control panel terminology

a. The local keypad

Getting access

The local keypad is covered by a door on which the projector logo is screened.

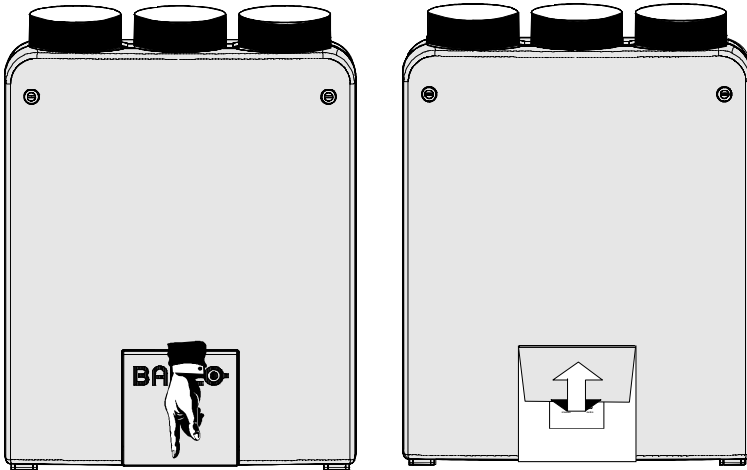

To open this door, push as indicated on next drawing and turn it to the front side of the projector.

b. RCU control panel terminology

This remote control includes a battery powered infrared (IR) transmitter that allows the user to control the projector remotely.

This remote control is used for source selection, control, adaptation and set-up. It includes automatic storing of :

- picture controls (Brightness, Sharpness,...)
- picture geometry adjustments
- convergence adjustments

Other functions of the remote control are:

- switching between standby and operational modes
- switching to "pause" (blanked picture, full power for immediate restarting)
- direct access to all connected sources
- variable adjustment speed : when pushing continuously on the arrow keys or the picture keys, the adjustment will be executed in an accelerated fashion.

LOCATION AND FUNCTION OF CONTROLS

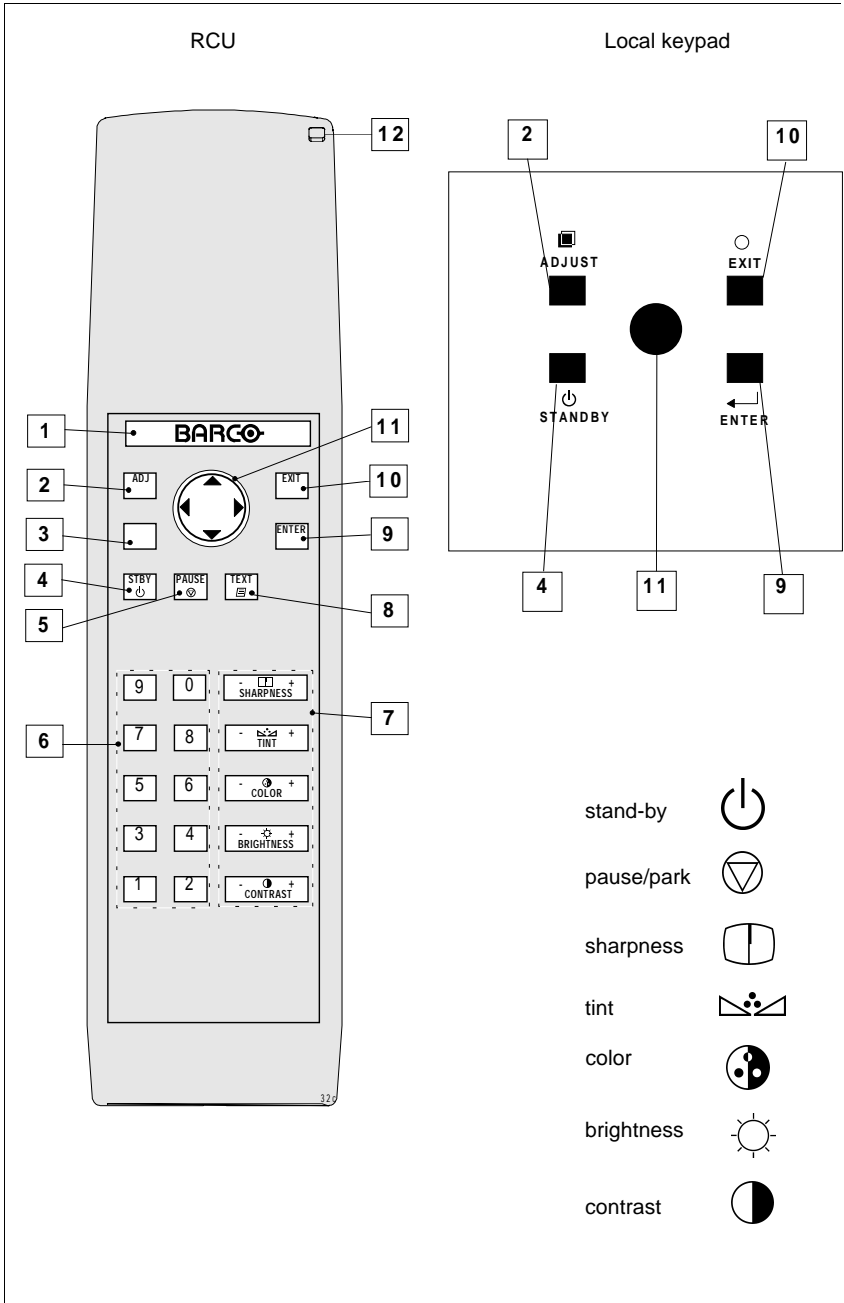

LOCATION AND FUNCTION OF CONTROLS

LOCATION AND FUNCTION OF CONTROLS

- 1** **Backlight key** : when activated, all keys will be lit up and visible in the dark.
- 2** **ADJ.** : adjust key, to enter or exit the adjustment mode.
- 3** **Address key** (sunk key), to enter the address of the projector (between 0 and 9). Press the address key, followed by pressing one digit button between 0 and 9.
- 4** **STBY** : stand by button : - to initiate remote power up operation
- to stop projection without main power off.
- 5** **Pause** :to blank the image, press PAUSE. The image disappears but full power is retained for immediate restarting.
- 6** **Digit buttons** : direct input selection.
- 7** **Picture controls** : use these buttons to obtain the desired level (see also 'Controlling') for each picture function.
- 8** **TEXT** : when adjusting one of the image controls during a meeting, the displayed bar scale can be removed by pressing 'TEXT' key first. To re-display the bar scale on the screen, press 'TEXT' key again. 'TEXT' key is only active in operational mode. When 'TEXT' is off, no warning message will be displayed.
- 9** **ENTER** : to start up the adjustment mode or to confirm an adjustment or selection in the adjustment mode.
- 10** **EXIT** : to leave the adjustment mode or to scroll upwards when in the adjustment mode.
- 11** **Control disk** : to make menu selections when in the adjustment mode. Also allows to increment or decrement an adjustment in the adjustment mode.
 - control disk up = up arrow in the menus
 - control disk down = down arrow in the menus
 - control disk to the right = arrow to the right on the menus
 - control disk to the left = arrow to the left on the menus
- 12** **RC operating indication** : lights up when a button on the remote control is pressed. (This is a visual indicator to check the operation of the remote control)

POWER (MAINS) CONNECTION

Power (mains) cord connection

Use the supplied power cord to connect your projector to the wall outlet. Plug the female power connector into the male connector at the front of the projector.

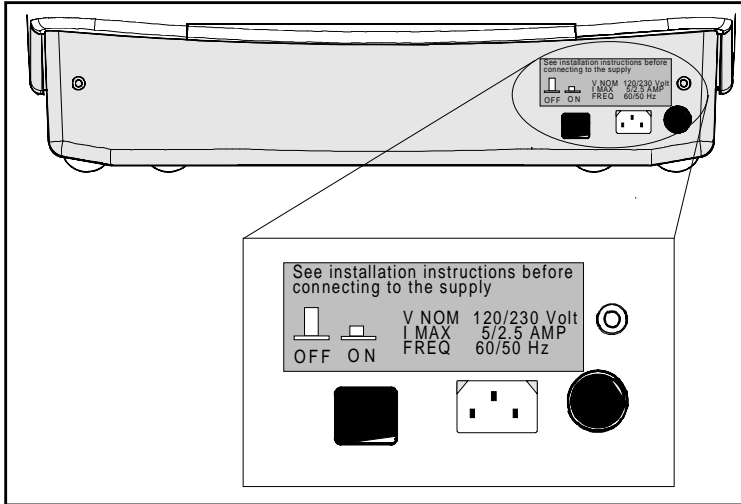

Switching on/off

The projector is switched ON and OFF using the power (mains) switch ON/OFF.

Pressed : ON

Not pressed : OFF

The projector can start now in the 'operational mode' (image displayed) or in the 'stand by mode', depending on the position of the 'power up' dip switch on the controller unit. This DIP switch is set during installation by a qualified technician. If you want to change this start up mode, call a qualified technician.

Stand by indication lamp :

no light up : projector in operational mode

red : projector is in stand by.

Leds on the front plate of the projector

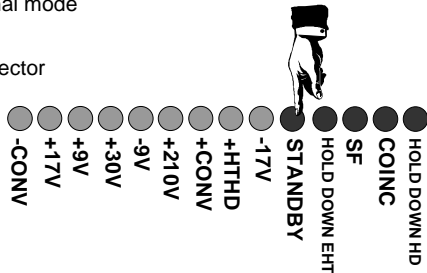

SOURCE CONNECTIONS

- connecting a Video source
- connecting a S-Video source
- connecting a RGSB or RGBS analog source
- connecting a RG3sB or RGB3S analog source
- connecting a (R-Y)Ys(B-Y) or (R-Y)Y(B-Y)S analog source
- connecting a (R-Y)Y3s(B-Y) or (R-Y)Y(B-Y)3S analog source

PERIPHERAL EQUIPMENT CONNECTION

- Connecting a computer, e.g. IBM PC (or compatible), Apple Macintosh to the RS232 input of the projector.
- connecting a RCVDS 05
- connecting a VSO5
- connecting an IR Remote Receiver

Signal input connection to the projector :

- Composite Video (*)
- S-Video (*)
- RGBS or RGsB
- RGB3S or RG3sB
- (R-Y)Y(B-Y)S or (R-Y)Ys(B-Y) [component input] (**)
- (R-Y)Y(B-Y)3S or (R-Y)Y3s(B-Y) [component input] (**)

(*) If the line double feature is built in, this feature is available via a software on/off toggle.

(**) If the line double feature is built in, this feature is available for component video signals on standard frequency via software on/off toggle.

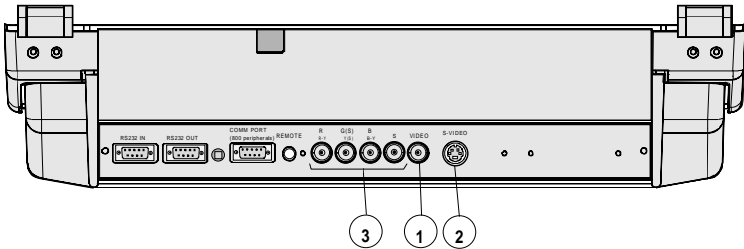

Source No	Projector input	Press digit button
1	Comp. Video	1
2	S-Video*	2
3	RGBS or RGsB**	3
4	RGB3S or RG3sB***	4
5	(R-Y)Y(B-Y)S or (R-Y)Ys(B-Y)****	5
6	(R-Y)Y(B-Y)3S or (R-Y)Y3s(B-Y)*****	6

* Input signal Y/C (luma/chroma)

** Input signal : R, G and B with composite sync on G or separate composite sync

*** Input signal : R, G and B with Tri level sync on G or separate Tri level sync.

**** Input signal : R-Y, Y and B-Y with composite sync on Y or separate composite sync

***** Input signal : R-Y, Y and B-Y with Tri level sync on Y or separate Tri level sync.

CONNECTIONS

Connecting a Composite Video source.

Composite video signals from a VCR, OFF air signal decoder, etc..

*If a line doubler is built in :
the default position of this line doubler is ON (active), the video input signal
will be displayed as a non interlaced image (= improved image stability).
To enable or to disable this line doubler function, enter the adjustment mode
and change the position of the ON/OFF toggle switch (see Picture tuning in
chapter 'Guided' adjustment mode or 'Random access' adjustment mode).*

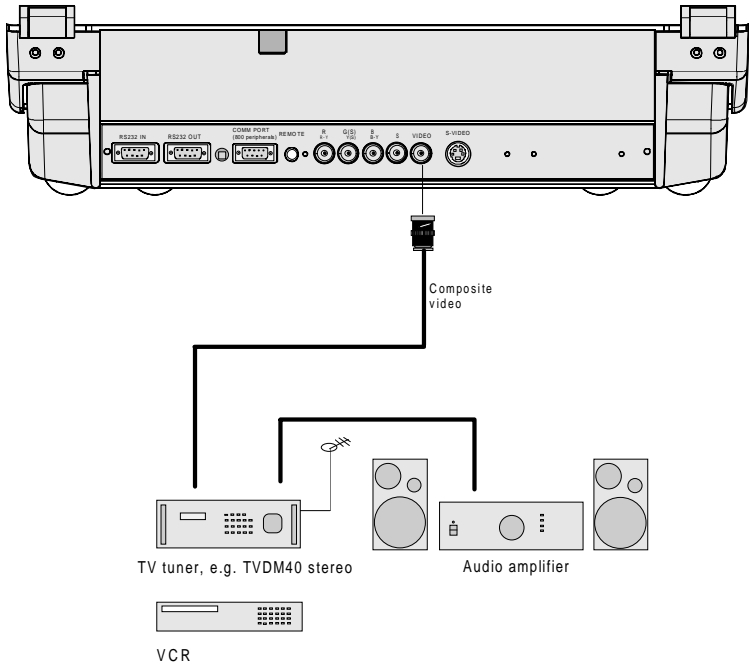

Video input selection :

- a. Press digit button 1 on the RCU or
- b. with the local keypad :

(to gain access to the local keypad, see Local keypad in chapter Location and function of control.)

- press **ADJUST** key, the General access menu is displayed on the screen.

- use the control disk to highlight 1.
- press **ENTER** to select the highlighted source.

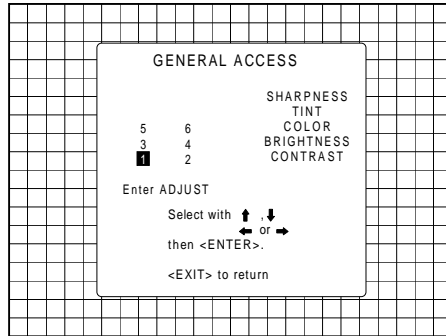

Connecting a S-Video source.

Separate Y-luma/C-chroma signals for higher quality playback of Super VHS signals.

*If a line doubler is built in :
 the default position of this line doubler is ON (active), the video input signal will be displayed as a non interlaced image (= improved image stability).
 To enable or to disable this line doubler function, enter the adjustment mode and change the position of the ON/OFF toggle switch (see Picture tuning in chapter 'Guided' adjustment mode or 'Random access' adjustment mode).*

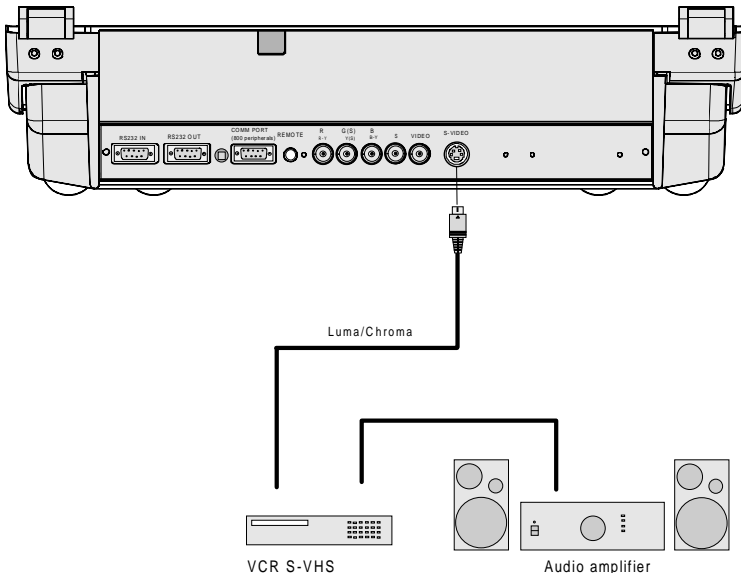

CONNECTIONS

S-Video input selection

a. Press digit button 2 on the RCU or

b. with the local keypad :

(to gain access to the local keypad, see Local keypad in chapter Location and functions of control.)

- Press **ADJUST** key, the General access menu is displayed on the screen.

- Use the control disk to highlight 2.
- Press **ENTER** to select the highlighted source.

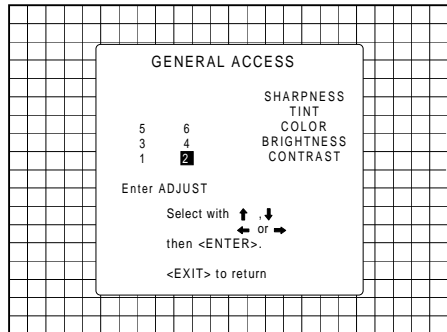

Connecting a RGB Analog source with composite sync.

RGB analog input terminals with composite sync input or with sync on green. The projector detects automatically where the sync signal is located.

Always use an interface when a computer and local monitor have to be connected to the projector. Examples of interfaces which can be applied :

Universal analog interface	R9826100
RGB 120 MHz Analog Interface	R9826570 (230V)
Multifunctional Analog Interface Kit (MAGIK)	R9828120 (230V)
VGA interface	R9828129 (120V)
	R9828070 (230V)
	R9828079 (120V)
MAC interface	R9828050 (230V)
	R9828059 (120V)

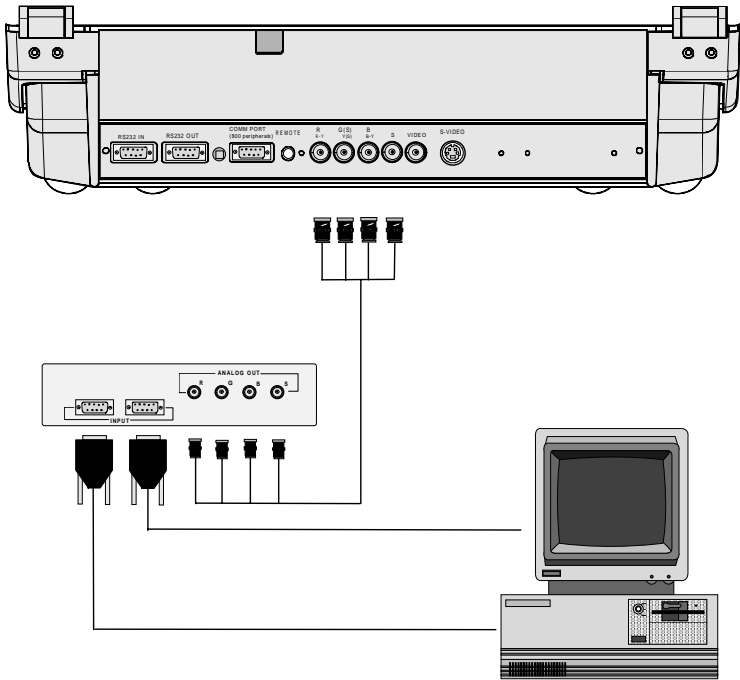

RGBS or RGsB input selection

- a. Press digit button 3 on the RCU or
- b. With the local keypad :

(to gain access to the local keypad, see Local keypad in chapter Location and functions of control.)

- Press **ADJUST** key, the General access menu is displayed on the screen.
- Use the control disk to highlight 3.
- Press **ENTER** to select the highlighted source.

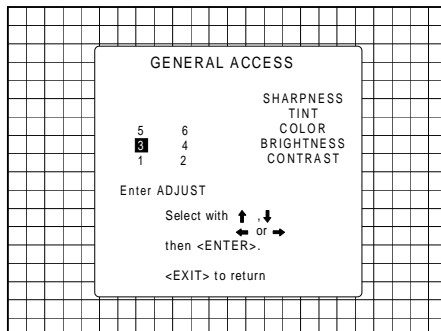

CONNECTIONS

Connecting a RGB Analog source with Tri-level sync.

RGB analog input terminals with Tri level sync input or with Tri-level sync on green. The projector detects automatically where the sync signal is located.

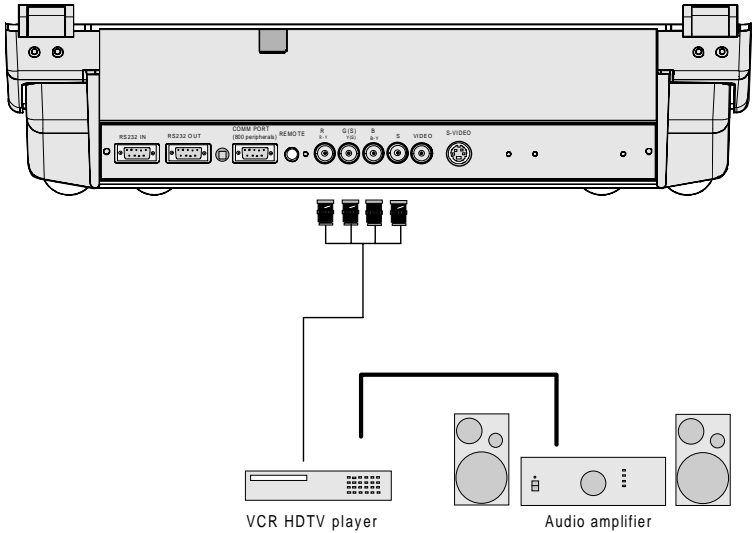

RGB3S or RG3sB input selection

- Press digit button 4 on the RCU or
- With the local keypad :
(to gain access to the local keypad, see Local keypad in chapter Location and functions of control.)
 - Press **ADJUST** key, the General access menu is displayed on the screen.
 - Use the control disk to highlight 4.
 - Press **ENTER** to select the highlighted source.

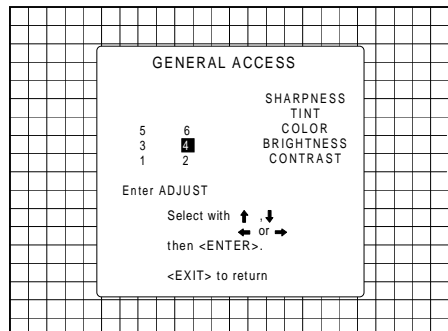

Connecting a Component source.

(R-Y)Y(B-Y) analog input terminals with sync input or with sync on the luminance (Y) input. The projector detects automatically where the sync signal is located. *Line doubling is possible for component video input sources on standard line frequency.*

*If a line doubler is built in :
the default position of this line doubler is ON (active), the component video input signal will be displayed as a non interlaced image (= improved image stability).
To enable or to disable this line doubler function, enter the adjustment mode and change the position of the ON/OFF toggle switch (see Picture tuning in chapter 'Guided' adjustment mode or 'Random access' adjustment mode).*

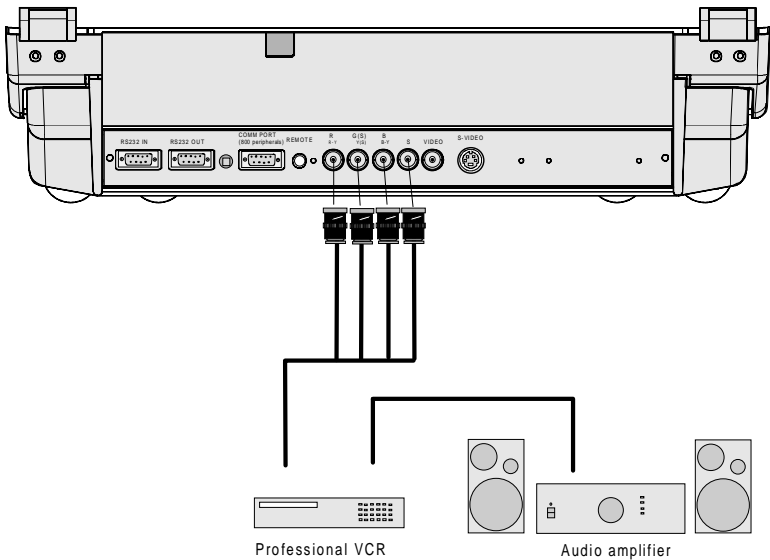

(R-Y)Y(B-Y)S or(R-Y)Ys(B-Y) input selection

- a. Press digit button 5 on the RCU or
- b. With the local keypad :
(to gain access to the local keypad, see Local keypad in chapter Location and functions of control.)
 - Press **ADJUST** key, the General access menu is displayed on the screen.

CONNECTIONS

- Use the control disk to highlight 5.
- Press **ENTER** to select the highlighted source.

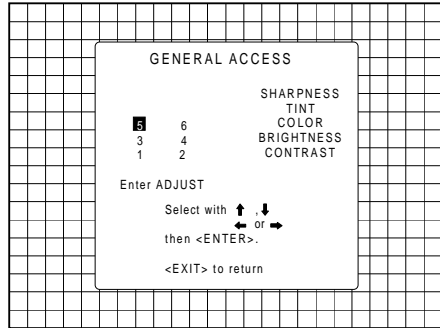

Connecting a Component source with Tri-level sync.

(R-Y)Y(B-Y) analog input terminals with Tri-level sync input or with Tri-level sync on the luminance input.

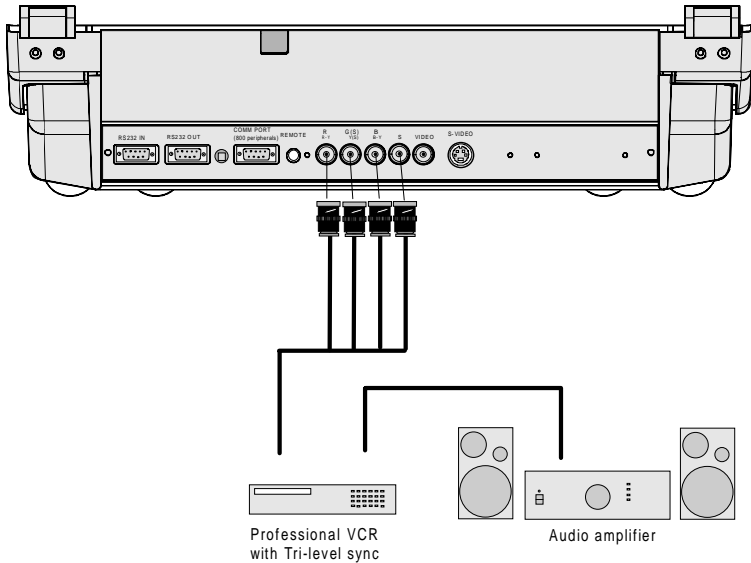

(R-Y)Y(B-Y)3S or (R-Y)Y3s(B-Y) input selection

- a. Press digit button 6 on the RCU or
- b. With the local keypad :
 (to gain access to the local keypad, see Local keypad in chapter Location and functions of control.)
 - Press **ADJUST** key, the General access menu is displayed on the screen.
 - Use the control disk to high-light 6.
 - Press **ENTER** to select the highlighted source.

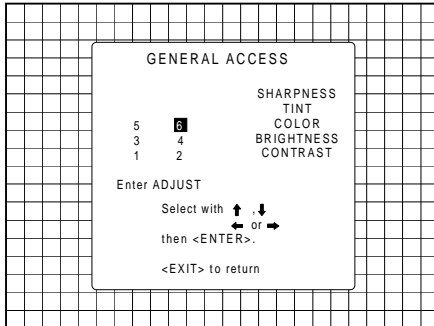

CONNECTIONS

Connecting a computer, e.g. IBM PC (or compatible), Apple Macintosh to the RS232 input of the projector.

The projector has a RS232 port that allows it to communicate with a computer.

Applications: remote control and data communications.

a) remote control:

- easy adjustment of the projector via IBM PC (or compatible) or MAC connection.
- allow storage of multiple projector configurations and set ups.
- wide range of control possibilities.
- address range from 0 to 255.

b) data communications:

- sending data to the projector or copying the data from the projector to a hard memory device.

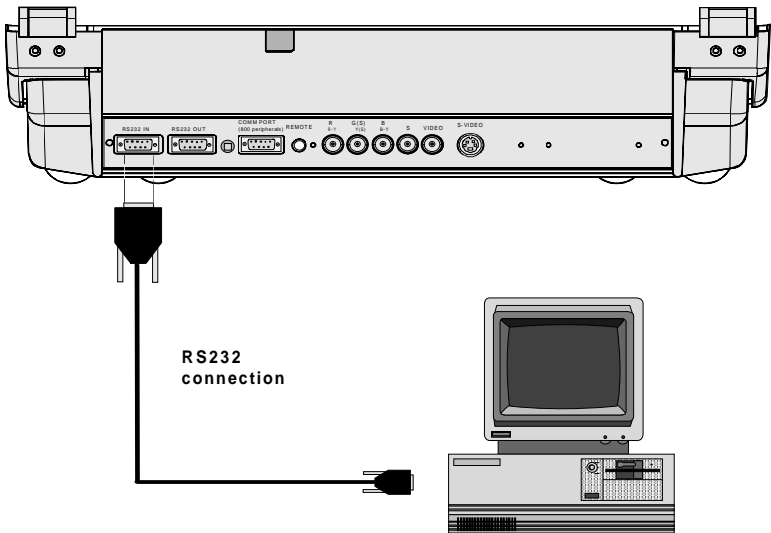

PERIPHERAL EQUIPMENT

Connecting a RCVDS 05 switcher to the projector.

- Up to 10 inputs (20 inputs when video and S-video) with the RCVDS 05 switcher and up to 90 inputs when 10 RCVDS switchers are linked via the expansion modules.
- Serial communication with the projector.
- Remote control buttons on the RCVDS to control the projector (source selection and analog settings)
- The selected source number will be displayed on a 2 digit display and the selected input modules will be indicated with a LED on the rear.

For more information about the use of the RCVDS 05, consult the Owner's Manual, order number: R5975765.

Connecting a VS05 switcher to the projector.

The VS05 can switch up to 5 Composite Video sources, 3 S-Video Sources and 1 RGB analog or component Video source to the projector. In addition, the audio signal proper to the source, can be switched to an audio amplifier.
Order number : R9827890.

For more information about the use of the VS05, consult the Owner's Manual, order number: R5975245.

Connecting an IR Remote Receiver to the projector

This infra-red receiver unit makes it possible to control the projector from another room. There is a communication line cable between the IR receiver and the projector or the RCVDS. The infrared control information from the Remote Control Unit is sent to the IR Remote Receiver. The IR Remote Receiver 800 displays the selected source on a 7-segment display.
Order number : R9827515.

CONTROLLING

Battery installation in the RCU

How to use the RCU

Projector address

How to display a projector address

How to program an address into the RCU

Input selection

Picture controls

The Pause key

Battery installation in the RCU.

A new battery (not yet installed to save the battery life time) is delivered inside the plastic bag with the power cord. Before using the RCU, start first the battery installation procedure.

Remove the battery cover on the backside of the remote control by pushing the indicated handle a little to the bottom of the RCU. Lift up the top side of the cover at the same time (fig. 1).

Insert the new 9 V battery (E-block type, e.g. 6F22S or equivalent) in the lower compartment and connect the battery to the contact plate.

Insert the battery into the lower compartment and put the cover back.

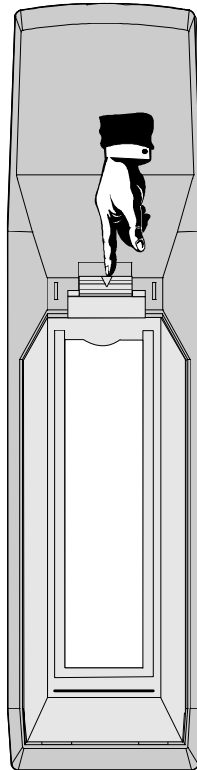
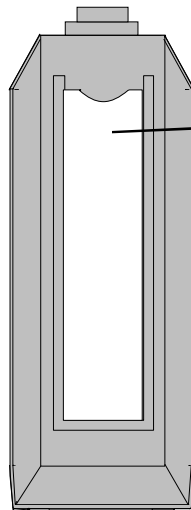
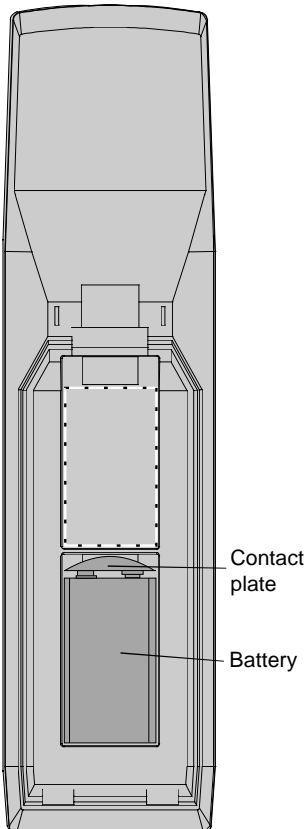

fig.1



Insert here, behind the plastic cover, the 'Insert card for RCU'. You can cut out the correct insert card on one of the last pages of this manual.

fig.2

310a.DRW

CONTROLLING

- The BARCOVISION 701 MULTIMEDIA can be controlled with
- the RCU
 - the hardwired RCU (cable not included)
 - the local keypad.

Controlling the projector with the RCU and the hardwired RCU is the same.

How to use the RCU

- Point the front of the RCU towards the reflective screen surface

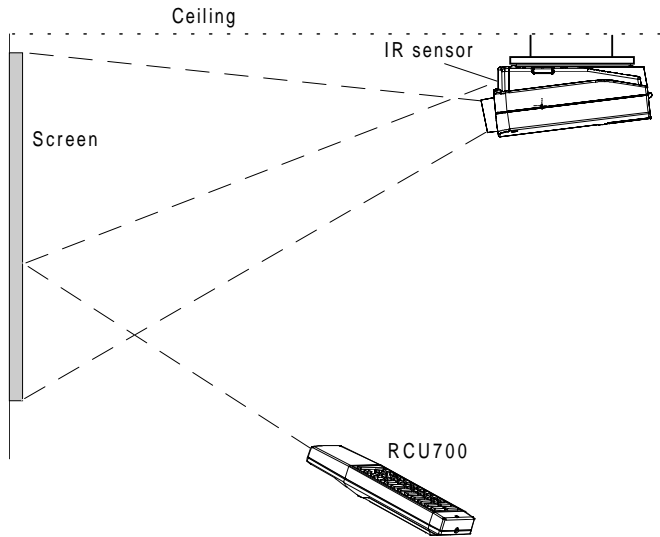

- Point the front of the RCU towards one of the IR sensors in the projector.

When using the wireless remote control, make sure you are within the effective operating distance (30m, 100ft in a straight line). The remote control unit will not function properly if strong light strikes the sensor window or if there are obstacles between the remote control unit and the projector's IR sensor.

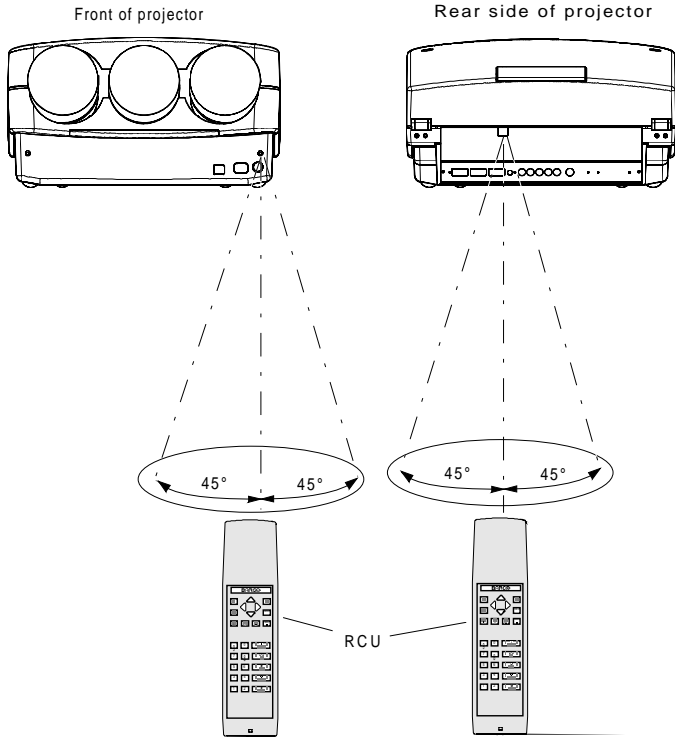

c) RCU used in a hardwired configuration.

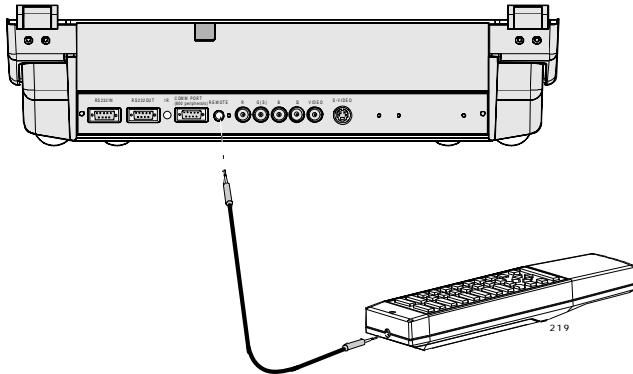

Plug one end of the remote cable in the connector on the bottom of the RCU and the second side in the connector in the rear panel of the BARCOVISION 701 MULTIMEDIA labelled 'REMOTE'.

Projector address

a. hardware set up of the projector address.

Every projector requires an individual address between 0 and 16 which is set with hardware DIP switches inside the projector. To change that address, contact a BARCO authorized technician.

b. How to control the projector.

The projector's address may be set to any value between 0 and 16. When the address is set, the projector can be controlled now with :

- the RCU for addresses between 0 and 9.
- computer, e.g. IBM PC (or compatible), Apple MAC, etc. for addresses between 0 and 16 (only when the optional RS232 communication port is installed)

Note : a projector will respond to an RCU set to an address of '0' regardless of what address is set in the projector itself.

c. Using the RCU.

Before using the RCU, it is necessary to enter the projector address into the RCU (only when that address is between 1 and 9). The projector with the corresponding address will listen to that specific RCU.

When address 0, 'zero address' is programmed into the RCU, every projector, without exception will listen to the commands given by this RCU.

How to display a projector address?

Press the ADDRESS key (recessed key on the RCU) with a pencil.

The projector's address will be displayed in a 'Text box'. This text box disappears after a few seconds.

To continue using your RCU, it is necessary to enter an address with the digit buttons (address between 0 and 9). For example : if the Address key displays projector address 003, the press "3" digit button on the RCU to set the RCU's address to match the projector's address. Do not press digit 003. This will address the remote to '0' and control all projectors in the room.

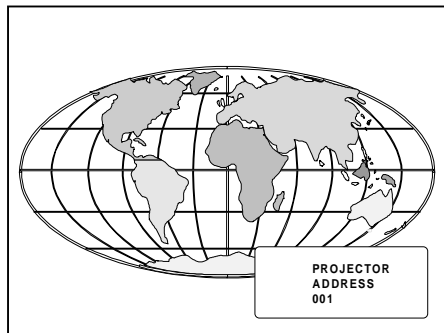

How to program an address into the RCU?

Press the ADDRESS key (recessed key on the RCU) with a pencil and enter the address with the digit buttons. That address can be any digit between 0 and 9. When programming '0', zero address, the RCU will control a projector regardless of the projector's address. This feature allows multiple projectors with different addresses to be controlled by a single RCU.

Input selection

Source No	Projector input	Press digit button
1	Comp. Video	1
2	S-Video	2
3	RGBS or RGsB	3
4	RGB3S or RG3sB	4
5	(R-Y)Y(B-Y)S or (R-Y)Ys(B-Y)	5
6	(R-Y)Y(B-Y)3S or (R-Y)Y3s(B-Y)	6

Two possible ways of selecting an input :

- a) With the digit buttons on the RCU, it is possible to select one of the four input sources, Video, S-Video, RGsB or RGBS, RG3sB or RGB3S, (R-Y)Ys(B-Y) or (R-Y)Y(B-Y)S, (R-Y)Y3s(B-Y) or (R-Y)Y(B-Y)3S.
- b) With the local keypad :

press first the **ADJUST** key to display the *General access menu*.

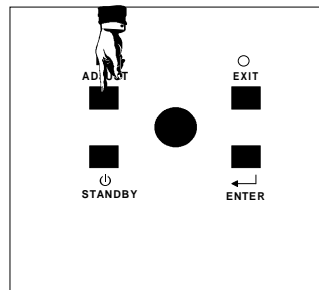

CONTROLLING

Use the control disk to highlight the desired source number. Push the control disk up or down to move the cursor up and down, push the control disk to the left or to the right to move the cursor to the left and to the right.

Press **ENTER** to confirm your selection.

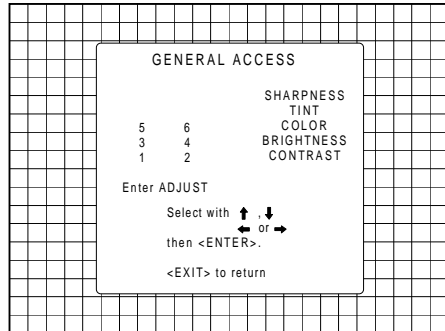

When a valid and available source is selected, there will be information displayed on the screen about that source. This information includes :

- Source number
- Horizontal frequency
- Vertical frequency

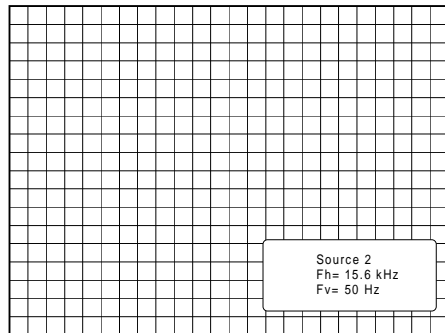

When the entry is a non valid source number, a warning appears on the screen : '*input not available*'.

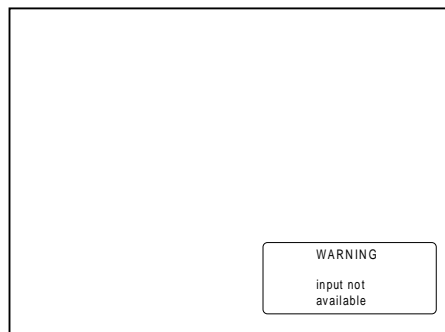

When a valid source number is selected, the projector will display this source or it will wait on the selected source number until the source becomes available. A message 'source not available' will be displayed for a short time.



Picture controls

The picture controls can be adjusted with :

- a) The RCU. The control keys are located on the left side of the key panel of the RCU and indicated with the name of the control and an icon.
When an image control is pressed, a text box with bar scale and the function name of the control, e.g. 'brightness...' appears on the screen (only if text is ON). The length of the bar scale indicates the current memorized setting for this source. The bar scale changes as the + or - buttons of the control are pressed.
- b) The local keypad
All controls are hidden in the General access menu.

- Press **ADJUST** to display the *General access* menu.
- Use the control disk to highlight the desired analog control and press **ENTER** to select.

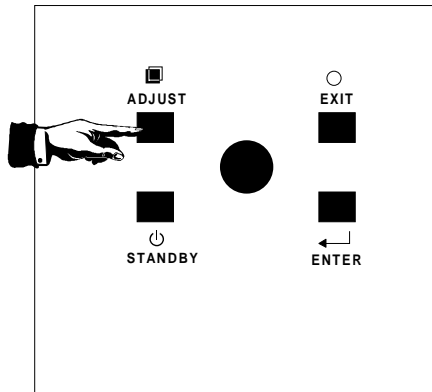

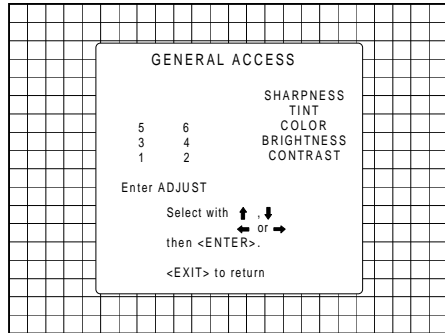

When a picture control is selected, a text box with bar scale and the function name appear on the screen. The length of the bar scale indicates the current memorized setting for this source (percentage scale). The bar scale changes as the control disk is pushed to the left or to the right.

Brightness Control

A correct 'brightness' setting is important for good image reproduction. Adjust the brightness with the + button and - button (RCU) or pushing the control disk to the left or to the right (local keypad) until the darkest parts of the picture appear black.

A bar scale gives a visual indication on the screen of the current brightness setting while pressing on the above indicated buttons. If the bar scale is not visible on the screen, press 'TEXT' once and retry the above indicated buttons.

The bar scale increases when pressing on the + button (higher brightness) and decreases when pressing on the - button (lower brightness).

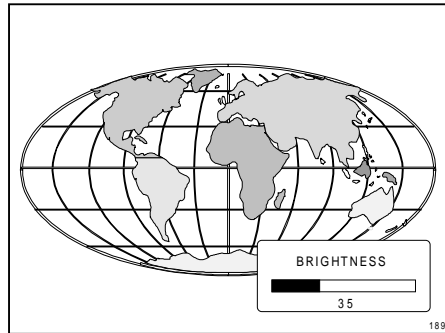

Contrast Control

A correct 'contrast' setting is important for good image reproduction. Adjust the contrast to the level you prefer, according to room lighting conditions.

A bar scale gives a visual indication on the screen of the current contrast setting while pressing the + or - buttons (RCU) or pushing the control disk to the left or to the right (local keypad). If the bar scale is not visible on the screen, press 'TEXT' key once and retry the above indicated buttons.

The bar scale increases when pressing on the + button (higher contrast) and decreases when pressing on the - button (lower contrast).

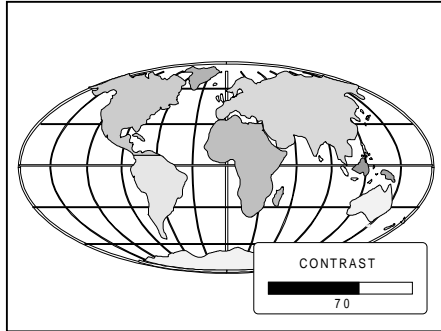

Color Saturation Control

Color saturation is only active for Video and S-Video. Adjust the color intensity of the picture. Adjust the color saturation using the + and - buttons (RCU) or pushing the control disk to the left or to the right (local keypad). A bar scale gives a visual indication on the screen of the current color setting while pressing on the above indicated buttons. If the bar scale is not visible on the screen, press 'TEXT' key once and retry the above indicated buttons. The bar scale increases when pressing on the + button (richer colors) and decreases when pressing the - button (lighter colors).

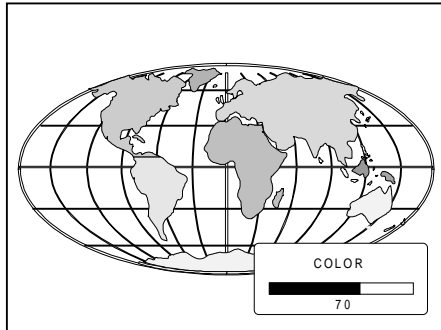

CONTROLLING

Tint Control

Tint is only active for Video and S-Video. Tint control is effective only when using the NTSC 4.43 or NTSC 3.58 system. A bar scale gives a visual indication on the screen of the current tint setting while pressing the + or - buttons (RCU) or pushing the control disk to the left or to the right (local keypad). If the bar scale is not visible on the screen, press the **'TEXT'** key once and retry the above indicated buttons.

The bar scale increases when pressing on the + button and decreases when pressing the - button.

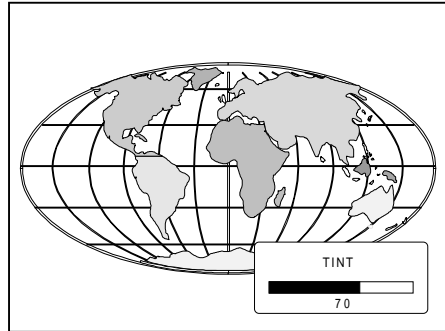

Sharpness Control.

Sharpness control only active for Video and S-Video. A bar scale gives a visual indication on the screen of the current sharpness setting while pressing the + or - buttons (RCU) or pushing the control disk to the left or to the right (local keypad). If the bar scale is not visible on the screen, press **'TEXT'** key once and retry the above indicated buttons.

The bar scale increases when pressing on the + button (sharper picture) and decreases when pressing on the - button (softer picture).

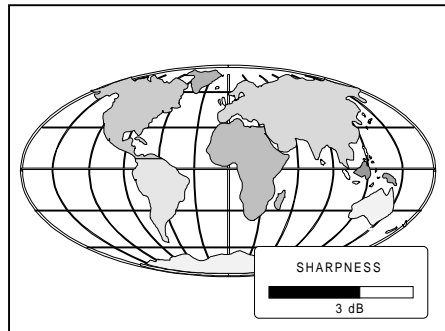

The Pause key.

When the Pause key is pressed, the image projection is stopped but the projector remains with full power for immediate restart.

To restart the image :

- Press the Pause key,
- Select a source number.

START UP OF THE ADJUSTMENT MODE

Entering the adjustment mode

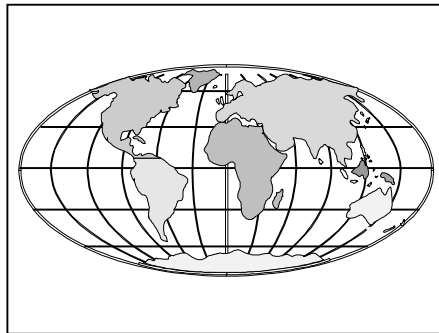

ADJUSTMENT MODE

Select a path from below:

- GUIDED
- RANDOM ACCESS
- INSTALLATION
- SERVICE
- IRIS

source 1

Select with ↑ or ↓
then <ENTER>
<EXIT> to return

Installation
(only for qualified technician)

Random Access Adjustment

Guided Adjustment

Service

IRIS

START UP OF THE ADJUSTMENT MODE

Adjustment mode

All picture geometry and convergence adjustments are made while in the 'Adjustment mode'. Two possible ways to enter the adjustment mode :

a) Using the RCU.

Press the **ADJUST** key.
The projector displays the path selection menu.

b) Using the local keypad.

Press the **ADJUST** key.
The projector displays the *General access menu*.

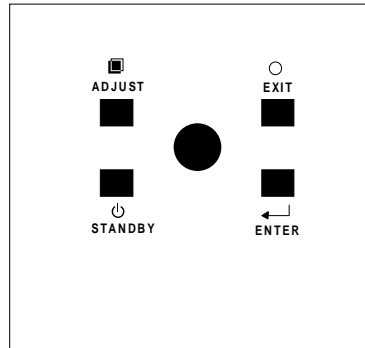

Use the control disk to highlight *enter ADJUST* and press **ENTER**. The path selection menu will be displayed.

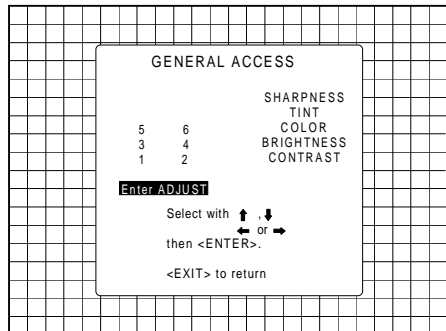

START UP OF THE ADJUSTMENT MODE

Note : to adjust the Analog picture control while in the 'Adjustment mode', press the **ADJUST** key. The next General Access menu will be displayed.

Push the control disk up or down to select the analog control to be adjusted and press the **ENTER** key to confirm. When the analog control is adjusted the projector returns automatically to the General access menu. When you want to return to the Adjustment mode, press **EXIT**, otherwise select *quit ADJUST* and press **ENTER** to return to operational mode.

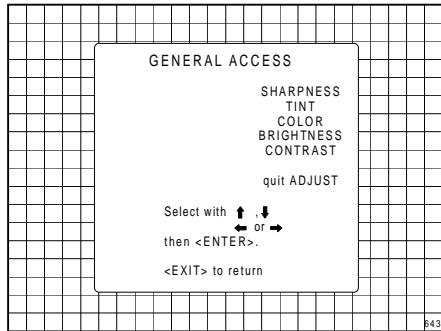

You are now in the 'Adjustment mode'. The control disk is used to make menu selections and also vertical and horizontal adjustments. The **ENTER** and **EXIT** keys are used to move forward and backward through the menu structure. The **ADJUST** key can be used to terminate the adjustment mode while a path selection menu (head menu) is displayed.

There are 5 possible paths to follow once in the Adjustment mode. They are :

INSTALLATION - Installation should be selected if the projector has been relocated and/ or a different screen size is desired.

When selecting 'Installation', the user or operator will be warned to call a qualified technician to perform the installation procedure (see example of projected warning on next page).

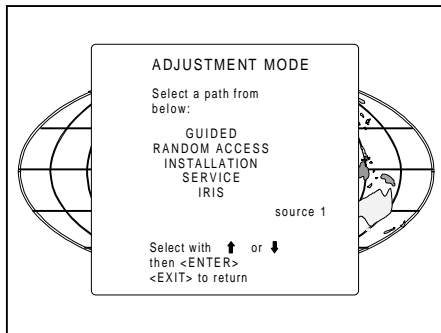

GUIDED - Guided should be selected if the user intends to perform a complete alignment of the projected image. All of the necessary geometry and convergence adjustments are made in a predetermined sequence.

RANDOM ACCESS - Random Access should be selected if the user intends to make only a few adjustments.

SERVICE - Service should be selected if the user intends to delete blocks, change password or apply information.

IRIS - This selection will only be available when the autoconvergence unit IRIS is connected to the projector.

START UP OF THE ADJUSTMENT MODE

While in Guided or Random Access adjustment Mode, the user may use an external source, an internally generated genlocked pattern or an internally generated multifrequency cross hatch pattern as a setup pattern.

Warning during the start up of the installation mode.



Some items in the Adjustment mode are password protected. While selecting such an item, the projector asks you to enter your password. (Password protection is only available when the password DIP switch on the controller module is in the ON position. Contact a BARCO authorized technician when no password is requested during the adjustment procedure and password protection is desired.)

Your password contains 4 digits.

a) Adjusting the projector with the RCU.

Enter the digits with the numeric keys on the RCU.

Example : 2 3 1 9

For each digit entered, a 'X' appears on the screen under the displayed text 'enter password'.

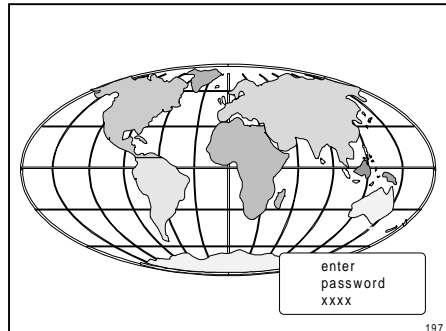

When your password is correct, you get access to the 'Adjustment mode'.

When the entered password is wrong, The message 'Wrong password !!!' will be displayed. The projector stays on the previous selected item.

Factory programmed password : **0000**

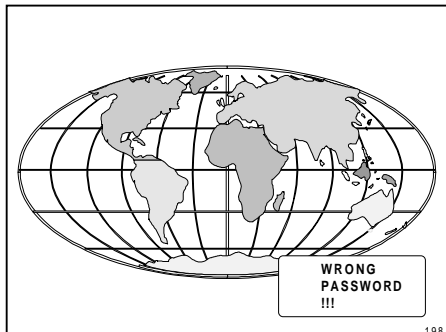

b) adjusting the projector with the local keypad.

When the 'compose password' menu is displayed, select with control disk the first digit of your password and press **ENTER**. Continue by selecting the second digit with the control disk and press **ENTER**. Handle in the same way for the third and fourth digit.

When your password is correct, you get access to the 'Adjustment mode'.

When the entered password is wrong, the message 'Wrong password' will be displayed.

Once the password is correctly entered, all other password protected items are accessible without re-entering your password.

When re-entering the adjustment mode, it will be necessary to enter your password again when selecting a password protected item.

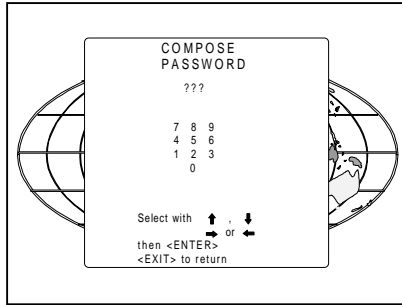

GUIDED ADJUSTMENT MODE

Start up of the guided adjustment mode.

Push the control disk up or down to highlight *GUIDED* on the 'Adjustment mode' menu and then press **ENTER**.

The Guided Adjustment mode is password protected (when the password function is active). Enter your password to continue (see also chapter Start up of the adjustment mode)

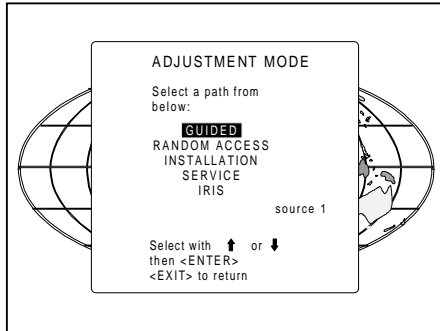

ENTER continues to the password menu and then to Setup Pattern Selection
EXIT returns to operational mode.

GUIDED ADJUSTMENT MODE

Overview flowchart 'Guided Adjustment' procedure.

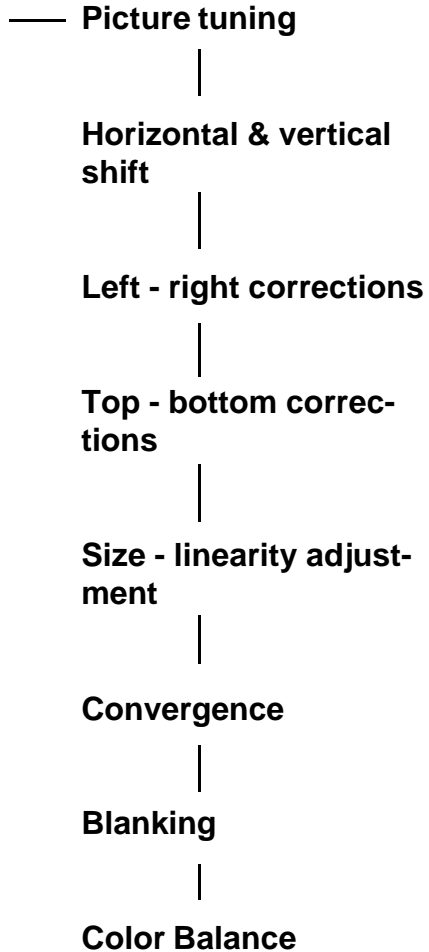
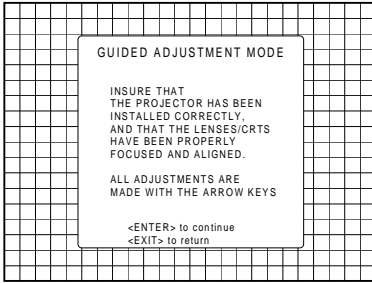

Selecting Setup Pattern

If an external source is connected to the projector, the Setup pattern menu will be displayed. Push the control disk up or down to highlight the desired setup pattern and then press **ENTER**.

Genlocked pattern : internally generated cross hatch pattern, locked on the external source.

Internal # pattern : internally generated cross hatch pattern and locked on internal generated sync signals. (No external source necessary)

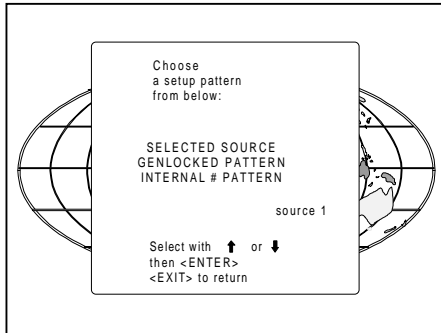

ENTER continues to Guided Adjustment Mode or Internal # Pattern Selection
EXIT returns to Path Selection
ADJUST returns to operational mode

If no external source is connected to the projector, the internal cross hatch pattern menu will be displayed.

The menus in this manual are created for an external source, connected to one of the inputs, and the 'Genlocked pattern' is selected.

GUIDED ADJUSTMENT MODE

Internal Cross Hatch Pattern

The Internal # pattern menu will be displayed if the internal cross hatch pattern has been selected or if no source is connected to the projector.

The table below lists the factory preset frequencies available.

Push the control disk up or down to highlight the desired cross hatch frequency and then press **ENTER**.

kHz/Hz

15.6/50	PAL/SECAM	48.5/60	SUPER VGA 1
15.7/60	NTSC	44.2/70	SUPER VGA 2
31.2/50	EDTV	61.0/76	SUPER VGA 3
31.5/60	IDTV	22.2/60	MAC CLASSIC
31.2/50	HDTV EUREKA		
31.5/60	HDTV ATV		
33.7/60	HDTV HI-VISION		
15.8/60	EGA 1		
21.8/60	EGA 2		
31.5/70	VGA 1,2		
35.5/87	VGA 4		

Note: Before continuing, insure that the lenses are properly focused and that the CRT projection angle is correctly adjusted. If any misalignment is noticed, consult a qualified service technician.

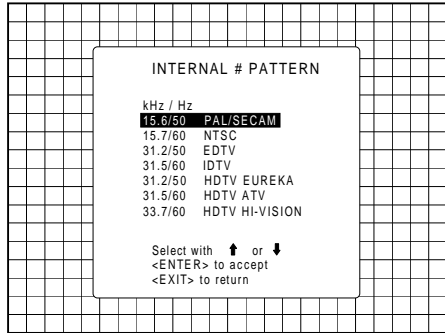

ENTER continues to Guided Adjustment Mode.

EXIT returns to Setup Pattern Selection.

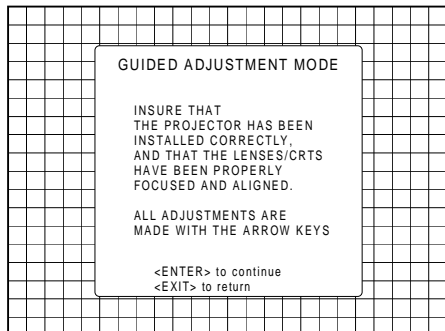

ENTER continues with the Picture Tuning

EXIT returns to Setup Pattern Selection or Internal # Pattern Selection

ADJUST returns to operational mode

Picture tuning

Depending on the source type (video, S-Video, RGB(S) analog with composite or Tri-level sync, component input with composite or Tri-level sync) the picture tuning menu offers the possibility to toggle :

For Video, S-Video or Component video sources :

- The Synchronisation speed
- The Line Doubler feature (option)

For RGB analog or component input with composite or tri-level sync sources:

- Synchronisation speed
- Enhanced blue on or off

Sync Fast/Slow toggle

Highlight *Sync* by pushing the control disk up or down and press **ENTER** to toggle between FAST and SLOW

Note : SYNC is normally used in the SLOW position. The FAST position is used to compensate for unsteady sync pulses from older video playback equipment.

Hint : when the line doubler feature is ON (active), toggle the sync to FAST.

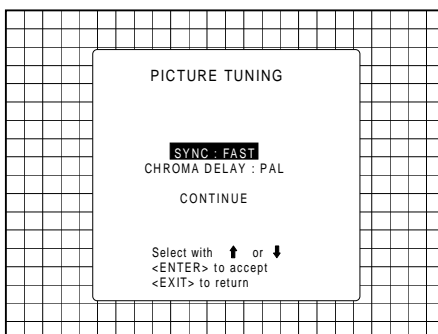

ENTER toggles between SLOW and FAST.
EXIT returns to the Guided Adjustment menu.

Line Doubler (option)

Line doubling is only possible for Video, S-Video or Component Video images on standard line frequency.

To eliminate the video line patterns and to improve the image stability the line doubler has to be switched on. The line doubler is default set in the ON position when starting up for the first time. The setting of the line doubler will be saved together with the source number.

Hint : when the line doubler feature is ON (active), toggle the sync to FAST.

When a bad video tape has to be displayed, switch off the line doubler feature to obtain a stable image.

GUIDED ADJUSTMENT MODE

Highlight *Line Doubler* by pushing the control disk up or down and press **ENTER** to toggle between ON (active) and OFF (non active)

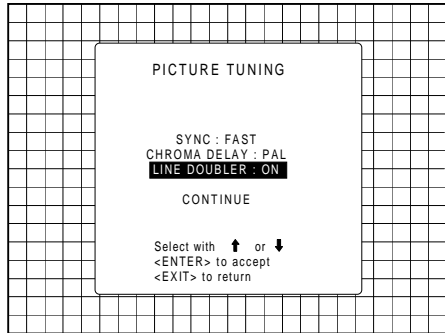

ENTER toggles between ON and OFF.
EXIT returns to the Guided Adjustment Menu.

Enhanced blue ON/OFF

Highlight *Enhanced Blue* by pushing the control disk up or down and press **ENTER** to toggle between ON and OFF (only available when RGB analog signals are connected to the projector). When Enhanced Blue is ON, the blue color will be displayed as cyan.

Note : Enhanced blue is only used when an RGBS or RGsB analog signal from a computer is being displayed. Enhanced blue is not recommended for non computer generated images.

For displaying graphics, this Enhanced Blue function could falsify the color reproduction. In this case, put Enhanced Blue OFF

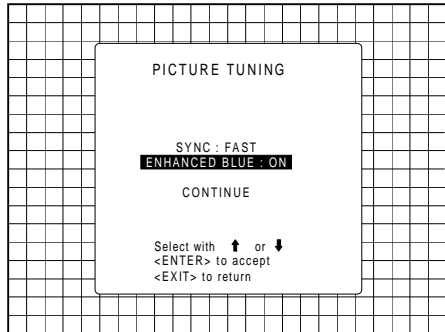

ENTER will toggle Enhanced Blue between ON and OFF.
EXIT will return to the Guided Adjustment menu.

Raster Centering on Green CRT Faceplate

The green raster must be centered both horizontally and vertically on the center of the CRT surface. To center the green raster, look into the green lens and use the control to move the raster.

Caution

It is necessary to look into the lenses to perform these adjustments. To avoid eye discomfort while looking into the lenses, reduce the contrast and gradually increase the brightness level until the raster becomes visible.

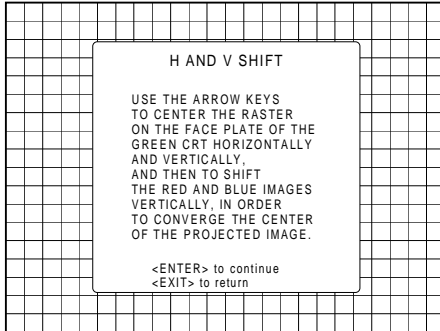

ENTER continues to Green Raster Shift
EXIT returns to Guided Adjustment Mode
ADJUST returns to operational mode

Warning : *In order to ensure maximum CRT longevity and to avoid CRT damage, do not shift the raster outside the phosphor area of the CRT.*

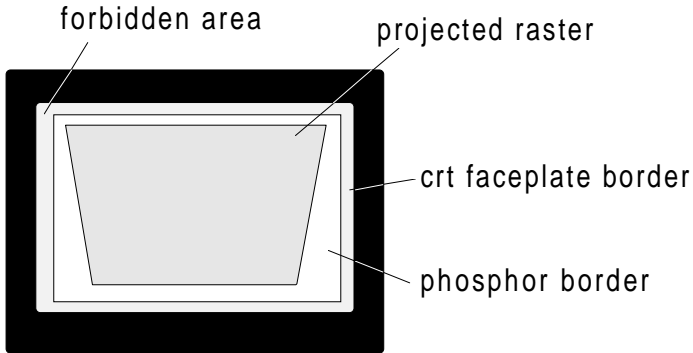

To begin the adjustment, press the **ENTER** key.

GUIDED ADJUSTMENT MODE

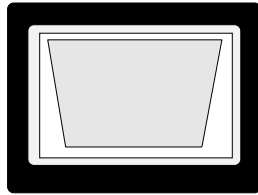

— correct raster position

wrong raster position

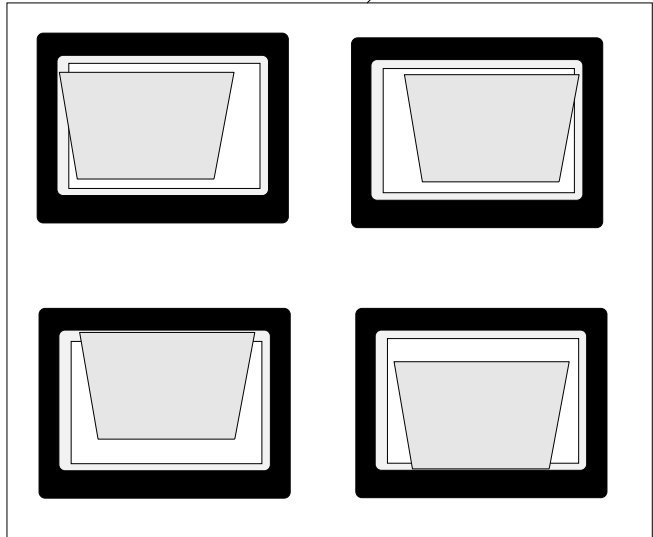

After centering the green raster, press the **ENTER** key to continue.

ENTER continues to Red Raster Shift
EXIT returns to Horizontal and Vertical Shift

Shifting Red and Blue on Green

Use the control disk to shift the red image until the center coincides with the center of the green image.

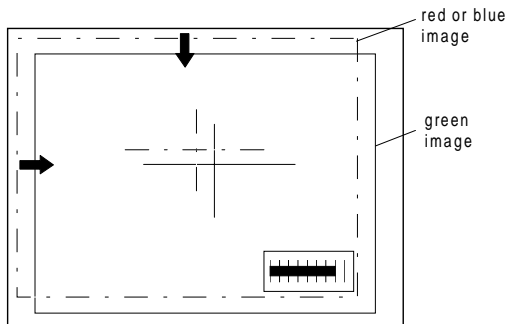

When the red image is correctly positioned, press the **ENTER** key to continue with the blue image.

ENTER continues to blue raster shift
EXIT returns to green raster shift

Left-Right (East-West) Adjustments

Left-right adjustments affect only the vertical lines of the setup pattern. Only the green image is displayed while making left-right adjustments. The red and blue images will automatically be corrected in the same manner.

Convergence corrections are automatically disabled for the duration of these adjustments.

Press the **ENTER** key to continue.

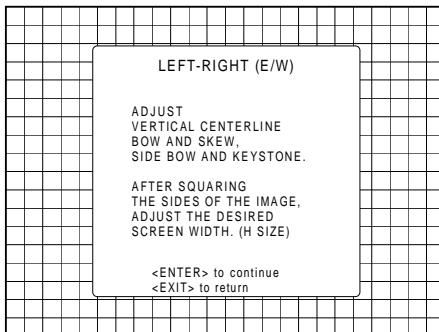

ENTER continues to vertical centerline bow adjustment
EXIT returns to Picture Tuning
ADJUST returns to operational mode

GUIDED ADJUSTMENT MODE

Vertical Centerline Bow Adjustment

The vertical centerline bow adjustment corrects for curvature in the horizontal direction in the middle of the picture for the vertical lines.

Push the control disk to the left or to the right to adjust the vertical centerline bow of the setup pattern and then press the **ENTER** key to continue.

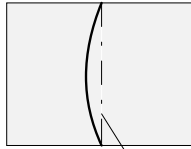

Vertical centerline

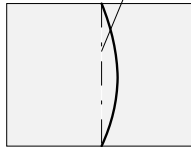

Correct by pushing the control disk to the right



Correct by pushing the control disk to the left



Vertical Centerline Skew Adjustment

The vertical centerline skew function corrects for tilting of the vertical lines in the middle of the picture.

Push the control disk to the right or to the left to adjust the vertical centerline skew of the setup pattern until this line is straight. Misalignment of the outer vertical lines will be corrected with the bow and key-stone corrections. Press **ENTER** to continue.

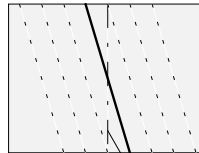

Vertical centerline

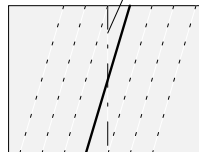

Correct by pushing the control disk to the right



Correct by pushing the control disk to the left



Right Keystone Adjustment

The right keystone function corrects the keystone geometry distortion of the vertical lines on the right side of the image.

Push the control disk to the right or to the left to adjust the right keystone (vertical lines) of the setup pattern and press **ENTER** to continue

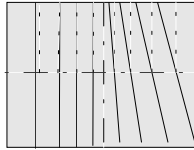

Correct by pushing the control disk to the right.

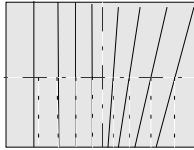

Correct by pushing the control disk to the left.



Left Keystone Adjustment

The left keystone function corrects the keystone geometry distortion of the vertical lines on the left side of the image.

Push the control disk to the right or to the left to adjust the left keystone (vertical lines) of the setup pattern and press **ENTER** to continue

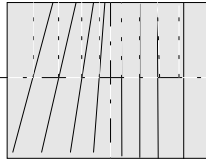

Correct by pushing the control disk to the right.

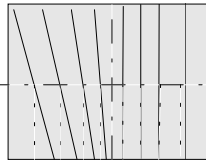

Correct by pushing the control disk to the left.



Right Bow Adjustment

The right bow function corrects for curvature occurring the vertical lines at the right of the displayed image.

Push the control disk to the right or to the left to adjust the right bow of the setup pattern (vertical lines) and press **ENTER** to continue.

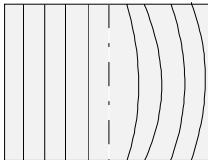

Correct by pushing the control disk to the right.

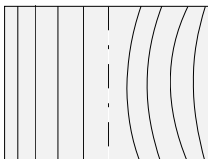

Correct by pushing the control disk to the left.

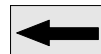

GUIDED ADJUSTMENT MODE

Left Bow Adjustment

The left bow function corrects for curvature occurring the vertical lines at the left of the displayed image.

Push the control disk to the left or to the right to adjust the left bow of the setup pattern (vertical lines) and press **ENTER** to continue.

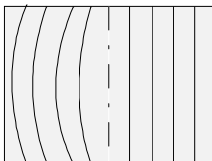

Correct by pushing the control disk to the right.

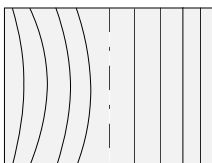

Correct by pushing the control disk to the left.



Horizontal Size Adjustment

Adjust the horizontal size by pushing the control disk to the left or to the right until the correct image width is obtained.

Note :

- if the internal # pattern was selected, this pattern remains on the screen.
- if the genlocked pattern was selected, the external source will be displayed.

A bar scale and a number indicator (between 0 and 100) give a visual indication of the horizontal size adjustment.

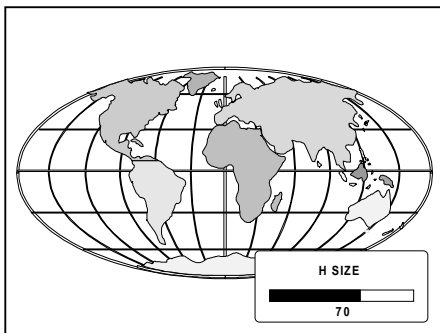

H size too large

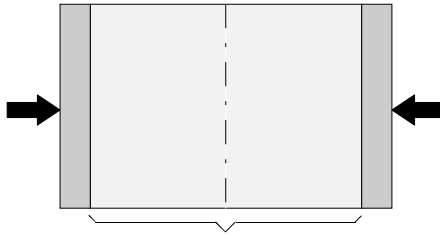

Ideal image width

Correct by pushing the control disk to the left.



H size too small

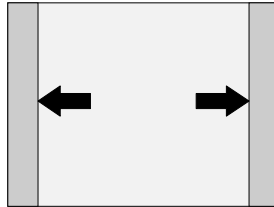

Correct by pushing the control disk to the right.



Top-Bottom (North-South) Adjustments

Top-Bottom adjustments affect only the horizontal lines of the setup pattern. These adjustments are performed only on the green image. The red and blue images are automatically corrected in the same manner.

Convergence corrections are automatically disabled for the duration of these adjustments.

Press the **ENTER** key to continue.

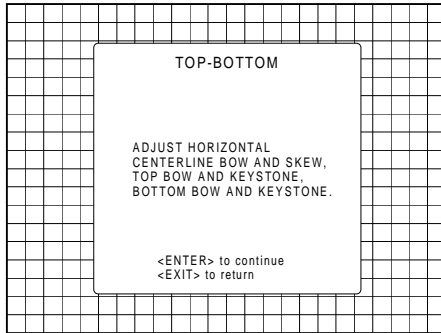

GUIDED ADJUSTMENT MODE

Horizontal Centerline Skew Adjustment

The horizontal skew function corrects for tilting of the horizontal lines in the middle of the picture.

Push the control disk up or down to adjust the horizontal centerline skew of the setup pattern.

A bar scale and a numeric indicator (between 0 and 100) will give a visual indication of the skew correction.

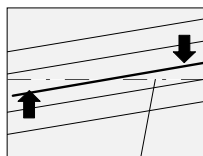

Correct by pushing the control disk up

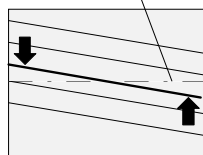

Correct by pushing the control disk down.



Horizontal Centerline Bow Adjustment

The horizontal centerline bow function corrects for curvature of the horizontal lines in the vertical direction in the middle of the picture.

Push the control disk up or down to adjust the horizontal centerline bow of the setup pattern.

A bar scale and a numeric indicator (between 0 and 100) will give a visual indication of the bow correction.

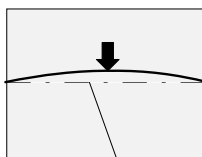

Correct by pushing the control disk down.

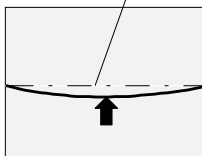
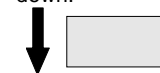

Correct by pushing the control disk up.



Top Keystone Adjustment

The top keystone function corrects for keystone geometry distortion of the horizontal lines in the upper part of the picture. Adjust the horizontal lines in the upper part of the picture with the control disk until these lines are straight. Press **ENTER** to continue.

A bar scale and a number indicator (between 0 and 100) will give a visual indication of the keystone correction.

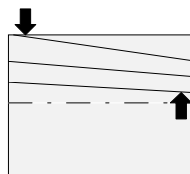

Correct by pushing the control disk down.

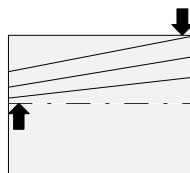

Correct by pushing the control disk up.



Top Bow Adjustment

The top bow function corrects for curvature occurring in the upper part of the image.

Adjust the bow of the horizontal lines in the upper side of the image by pushing the control disk up or down until these lines are straight.

A bar scale and a number indicator below indicate the amount of adjustment.

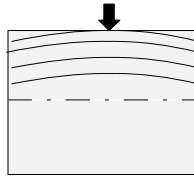

Correct by pushing the control disk up.

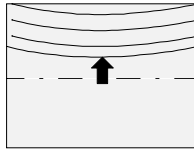

Correct by pushing the control disk down.



Bottom Keystone Adjustment

The bottom keystone function corrects for keystone geometry distortion of the horizontal lines in the lower part of the image. Adjust the horizontal lines in the lower part of the image by pushing the control disk up or down until these lines are straight.

A bar scale and a number indicator (between 0 and 100) will give a visual indication of the adjustment.

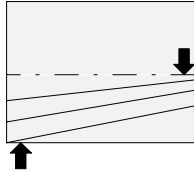

Correct by pushing the control disk up.

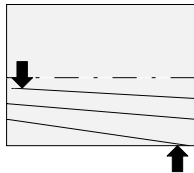

Correct by pushing the control disk down.



Bottom Bow Adjustment

The bottom bow function corrects for curvature occurring in the lower part of the image. Push the control disk up or down to adjust the bottom bow in the lower part of the setup pattern. Adjust until the horizontal lines are straight.

A bar scale and a number indicator (between 0 and 100 %) give a visual indication of the adjustment.

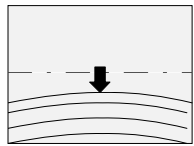

Correct by pushing the control disk up.

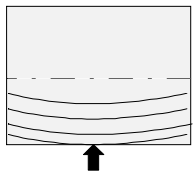

Correct by pushing the control disk down.



Size-linearity Adjustment

Size adjustments affect the height and width of the projected image. The vertical linearity adjustment is used to adjust the horizontal lines of the setup pattern until the spacing between them is even. The horizontal phase adjustment is used to shift the image horizontally across the raster.

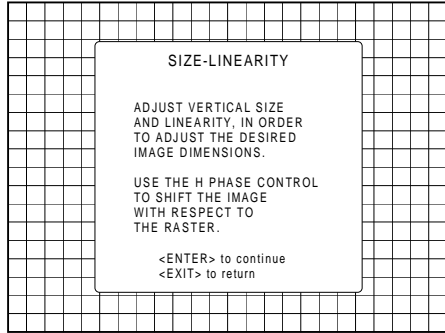

Vertical Linearity Adjustment

Adjust the vertical linearity with the control disk until the distance between the horizontal lines of the set up pattern are equal.

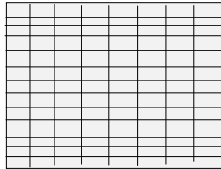

Correct by pushing the control disk up.



Correct by pushing the control disk down



Vertical Size Adjustment

Adjust the vertical size by pushing the control disk up or down until the exact image height is obtained.

Note :

- if the internal # pattern was selected, this pattern remains on the screen.
- if the genlocked pattern was selected, the external source will be displayed.

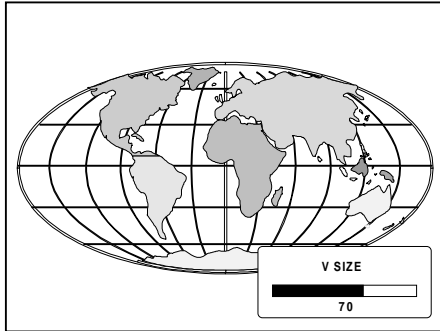

Hint :

In order to avoid loss of resolution in the projected image and to ensure maximum CRT longevity, do not use an excessively small vertical size setting.

A bar scale and a number indicator (between 0 and 100) give a visual indication of the vertical size adjustment.

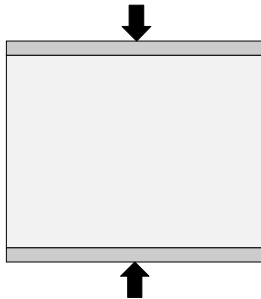

Correct by pushing the control disk down.

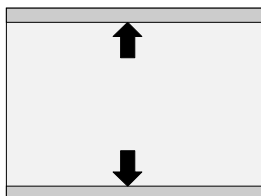
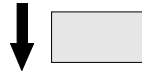

Correct by pushing the control disk up.



GUIDED ADJUSTMENT MODE

Horizontal Phase Adjustment

Note : No horizontal phase adjustment is available on the internal # pattern.

For external sources :
If the raster shift is correctly adjusted, the text box H phase is projected in the middle of the raster. At that moment, the >< indicates the middle of the raster.

Adjust the hor phase control until the middle of the projected image is equal with the middle of >< .

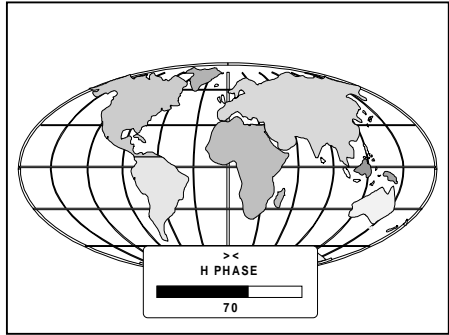

Note :

- if the genlocked pattern was selected, the external source will be displayed.

A bar scale and a number indicator (between 0 and 100) on the screen give a visual indication of the horizontal phase adjustment.

Correct by pushing the control disk to the right.

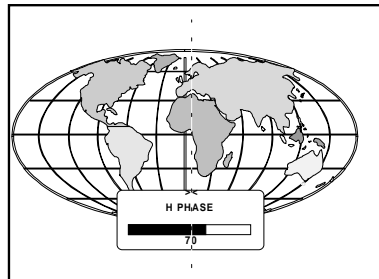

Correct by pushing the control disk to the left.

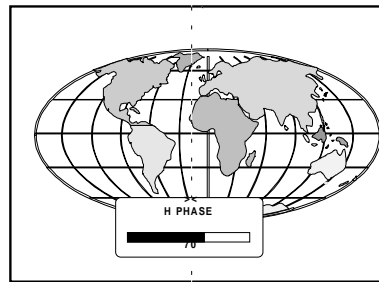

Convergence Adjustment

Convergence adjustments affect both the horizontal and vertical lines of the setup pattern. These adjustments are performed on the red image while superimposed on the green image and then on the blue image while superimposed on the green image.

The screen area is divided into 25 areas. Within each area it is possible to move the horizontal and vertical lines of the red and blue picture until they coincide with the green lines.

Use the control disk to make horizontal and vertical convergence adjustments in the area indicated by the box. Pressing ENTER will move the box to the next area of the setup pattern to be converged. Pressing EXIT will move the box back to the last area.

CONVERGENCE
 START WITH GREEN ONLY,
 THEN RED ON GREEN,
 THEN BLUE ON GREEN.
 USE THE ARROW KEYS FOR
 HORIZONTAL AND VERTICAL
 ADJUSTMENTS IN THE AREA
 INDICATED BY THE BOX.

 <ENTER> WILL MOVE
 THE BOX TO THE NEXT AREA
 TO BE CONVERGED, AND
 <EXIT> WILL MOVE IT BACK
 TO THE PREVIOUS.
 <ENTER> to continue
 <EXIT> to return

25	23	9	15	17
24	22	8	14	16
5	4	1	2	3
20	18	6	10	12
21	19	7	11	13

397

The 'guided adjustment' program will start with the convergence adjustment of the red picture on the green and continues with the blue image on the green image.

Attention : when green convergence adjustments are available (option). The control software starts with these green corrections (the menu will indicate it also). Adjust until the vertical and horizontal lines are straight.

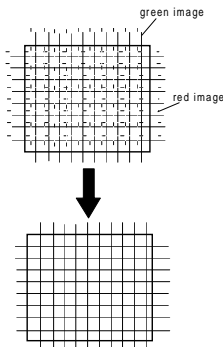

**CONVERGE
ADJUSTMENT**

 70

Blanking Adjustment

Blanking adjustments affect only the edges of the projected image and are used to frame the projected image on to the screen and to hide or black out unwanted information (or noise). A 0% on the bar scale indicates no blanking.

The following blanking corrections are possible :

- top blanking
- bottom blanking
- left blanking
- right blanking

Note :

- if the internal # pattern was selected, this pattern remains on the screen.
- if the genlocked pattern was selected, the external source will be displayed.

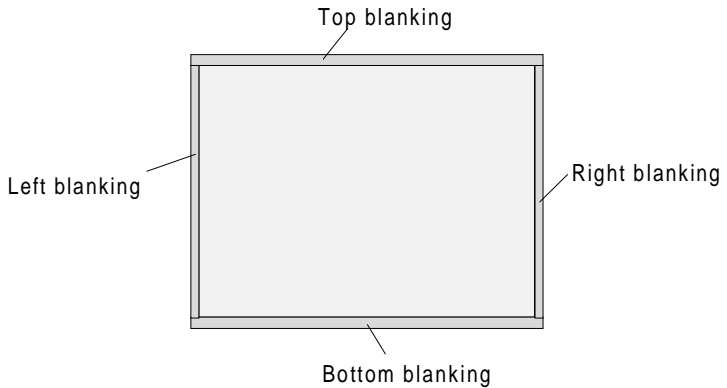
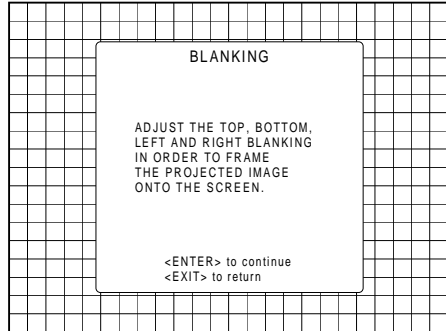

Top blanking adjustment

Push the control disk up or down to adjust the top blanking of the setup pattern. Press **ENTER** to continue.

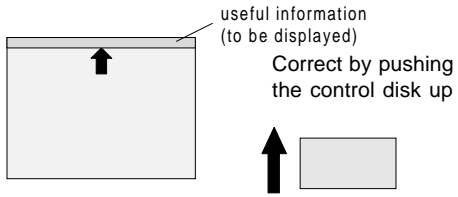
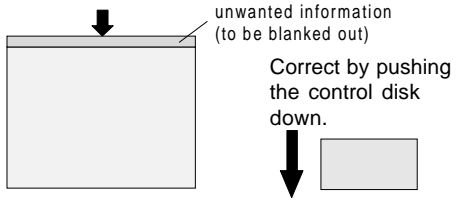

Bottom blanking adjustment

Push the control disk up or down to adjust the bottom blanking of the setup pattern.

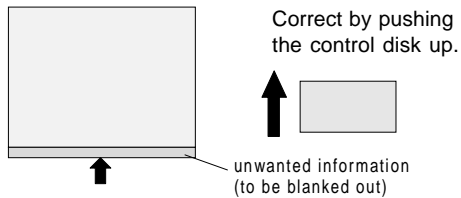
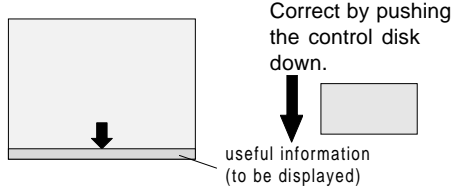

GUIDED ADJUSTMENT MODE

Left blanking adjustment

Push the control disk to the right or to the left to adjust the left blanking of the setup pattern.

ENTER continues to right blanking adjustment.

EXIT returns to bottom blanking adjustments.

unwanted information
(to be blanked out)

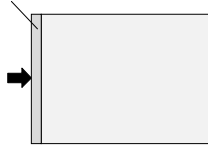

Correct by pushing the control disk to the right.

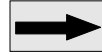

useful information
(to be displayed)

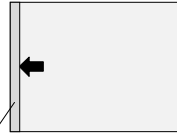

Correct by pushing the control disk to the left.



Right blanking adjustment

Push the control disk to the right or to the left to adjust the right blanking of the setup pattern.

unwanted information
(to be blanked out)



Correct by pushing the control disk to the left.

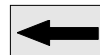

useful information
(to be displayed)

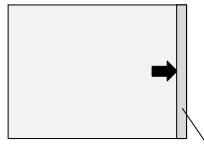

Correct by pushing the control disk to the right.



Color Balance

Use the control disk to select between :

- Fixed Color Balance (one of the 4 predefined values)
- Custom white balance
- Custom black balance

Fixed Color Balance

4 color temperatures are preprogrammed :

- 3200 K (reddish)
- 4900 K
- 6500 K (white)
- 9300 K (bluish)

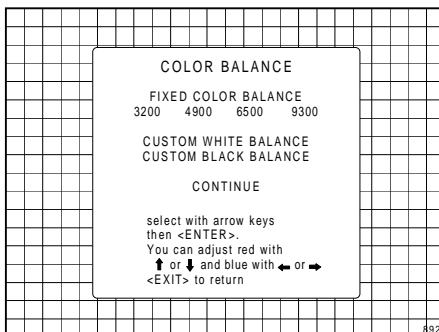

Select one of the 4 preprogrammed color temperatures with the control disk and press **ENTER** to display the desired color balance on the screen. Press **ENTER** again to continue.

Custom White Balance

Select custom white balance with the control disk and press **ENTER** to start the adjustment. Push the control disk up or down to adjust red gain and push the control disk to the right or to the left to adjust the blue gain. A bar scale indicates the amount of adjustment.

Custom Black Balance

Select custom black balance with the control disk and press **ENTER** to start the adjustment. Push the control disk up or down to adjust the red cut off and push the control disk to the right or to the left to adjust the blue cut off.

When the color balance is adjusted, select continue with the control disk and press **ENTER**.

RANDOM ACCESS ADJUSTMENT MODE

Starting up the random access adjustment mode

Overview flow chart 'Random Access adjustment mode'

Selecting Setup Pattern

Internal cross hatch pattern

Picture tuning

Color balance

Sync Fast/Slow

Line Doubler

Enhanced Blue

Geometry adjustments

Horizontal phase

Raster shift adjustment

Left-right adjustments

Top-Bottom adjustments

Horizontal size

Vertical linearity

Vertical size

Blanking adjustments

Convergence adjustments

Color select

Starting up the random access adjustment mode.

Push the control disk up or down to highlight "RANDOM ACCESS" and then press **ENTER**.

Some items in the Random access mode are password protected (when the password function is enabled). Enter your password to continue. All other password protected items are now also available if you stay in the adjustment mode.

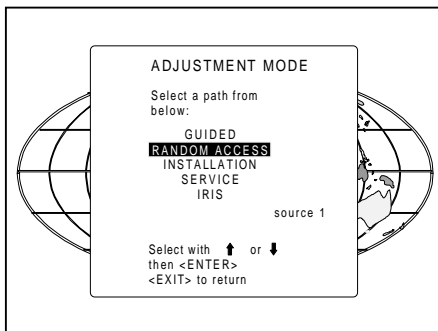

ENTER continues to Setup Pattern Selection

EXIT returns to operational mode

RANDOM ACCESS ADJUSTMENT MODE

Overview flowchart 'Random Access Adjustment' mode

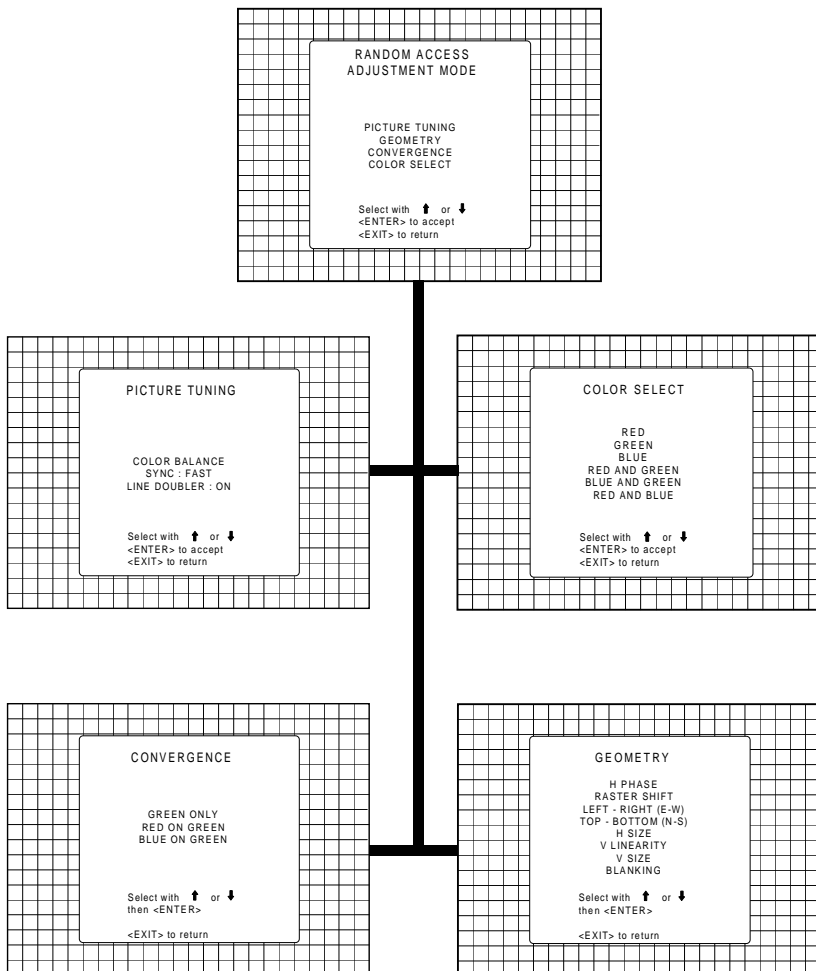

RANDOM ACCESS ADJUSTMENT MODE

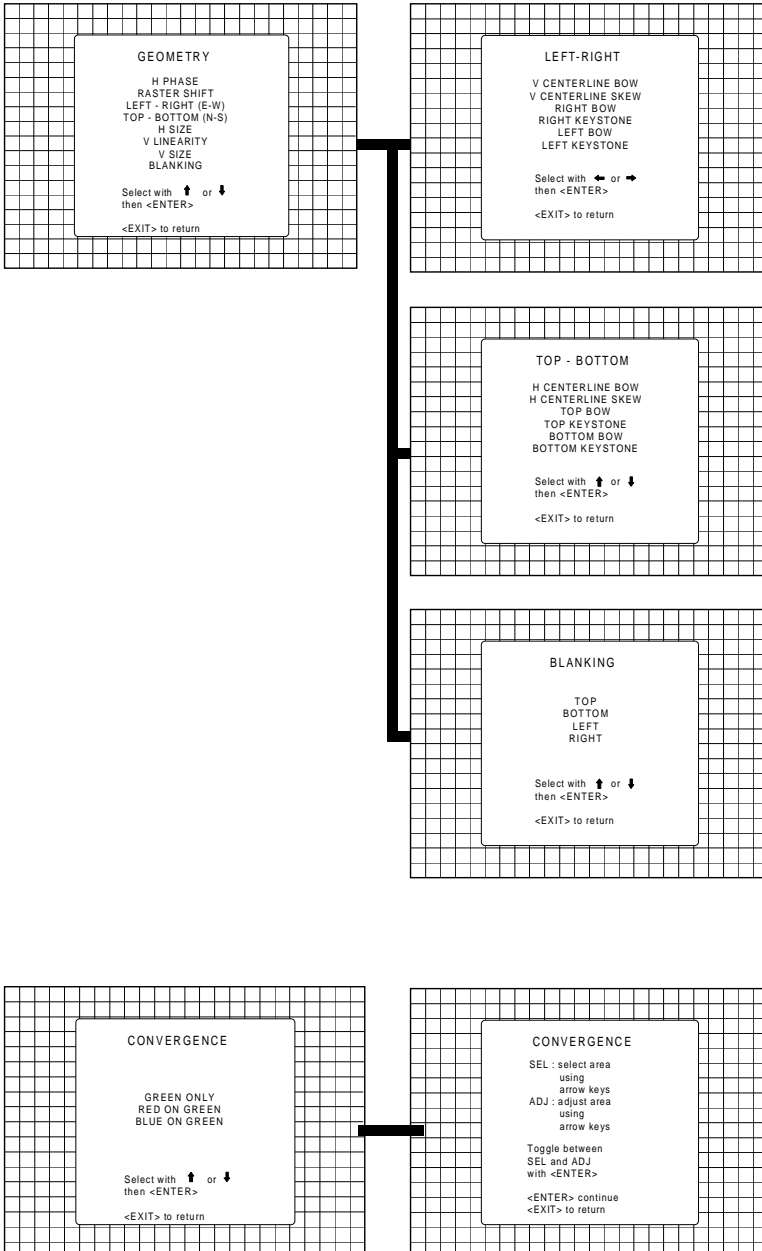

RANDOM ACCESS ADJUSTMENT MODE

Selecting Setup Pattern

If an external source is connected to the projector, the path selection menu will be displayed. Push the control disk up or down to highlight the desired setup pattern and then press **ENTER**.

Genlocked pattern : internally generated cross hatch pattern, locked on the external source.

Internal # pattern : internally generated cross hatch pattern and locked on internal generated sync signals. (No external source necessary)

If no external source is connected to the projector, the internal cross hatch pattern menu will be displayed.

The menus in this manual are created for an external source, connected to one of the inputs, and the 'Genlocked pattern' is selected.

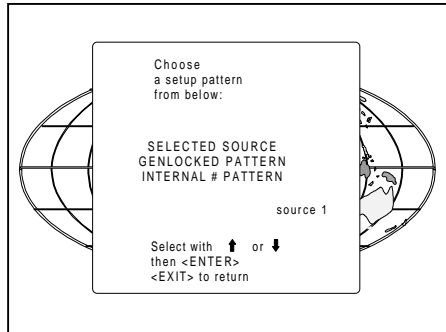

ENTER continues to Random Access Adjustment Mode or Internal # Pattern Selection
EXIT returns to Path Selection
ADJUST returns to operational mode

Internal Cross Hatch Pattern

The Internal # pattern menu will be displayed if the internal cross hatch pattern has been selected or if no source is connected to the projector.

The table below lists the factory preset frequencies available.

Push the control disk up or down to highlight the desired cross hatch frequency and then press **ENTER**.

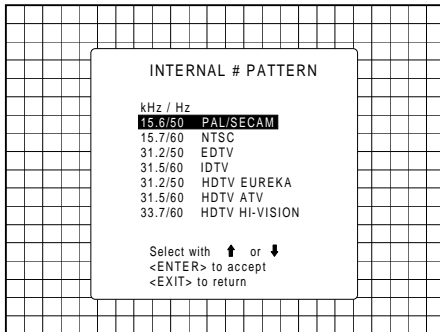

kHz/Hz

15.6/50	PAL/SECAM
15.7/60	NTSC
31.2/50	EDTV
31.5/60	IDTV
31.2/50	HDTV EUREKA
31.5/60	HDTV ATV
33.7/60	HDTV HI-VISION
15.8/60	EGA 1
21.8/60	EGA 2
31.5/70	VGA 1,2

ENTER continues to the Random Access Adjustment Mode.
EXIT returns to the Setup Pattern Selection menu.

35.8/87	VGA 4
48.5/60	SUPER VGA 1
44.2/70	SUPER VGA 2
61.0/76	SUPER VGA 3
22.2/60	MAC CLASSIC

Random access adjustment mode selection menu.

This is the main menu for the Random Access adjustment mode.

Through this menu, the following adjustments and features are accessible :

- Picture tuning enhanced blue (only for RGB)
- sync slow/fast(video/s-video)
- color balance
- Geometry
- Convergence
- Color select

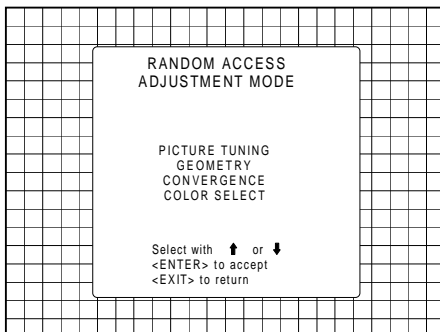

RANDOM ACCESS ADJUSTMENT MODE

Picture tuning

Highlight *Picture tuning* by pushing the control disk up or down and press **ENTER**.

The Picture tuning menu will be displayed.

Depending on the input source, the Picture tuning menu will display different items.

- Color balance
- Sync slow / fast
- Line doubling
- Enhanced blue ON/OFF

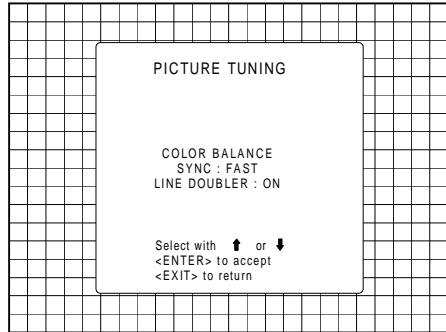

Color Balance

The Color Balance function is used to select or adjust the color temperature of white used by the projector. The Color Balance can be adjusted on two different ways :

- fixed color balance. You have the choice between 3200 K (reddish), 4900 K, 6500 K (white) or 9300 K (bluish).

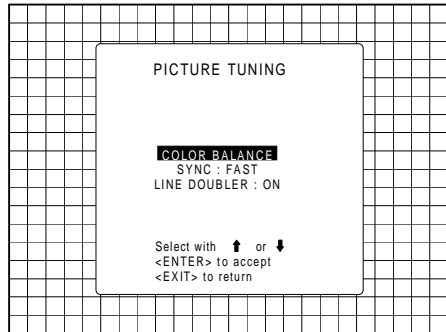

Fixed Color Balance.

Highlight one of the 4 pre-programmed color temperatures with the control disk and press **ENTER** to display the Color Balance.

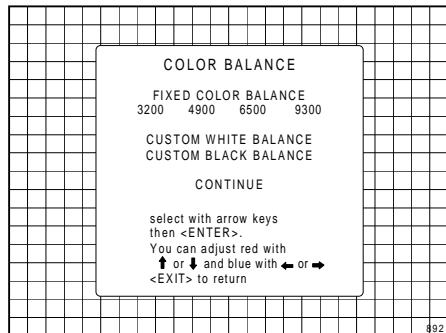

Custom Color Balance.

Select custom white balance by pushing the control disk up or down and press **ENTER** to start the adjustment.

Push the control disk up or down to adjust the red gain and push the control disk to the left or to the right to adjust the blue gain. A bar scale indicates the amount of adjustment.

Select custom black balance with the control disk and press **ENTER** to start the adjustment. Push the control disk up or down to adjust the red cut-off and push the control disk to the left or to the right to adjust the blue cut-off.

When the color balance is adjusted, select continue by pushing the control disk up or down and press **ENTER**

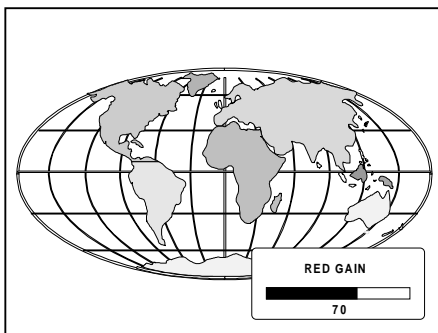

SyncFast/Slow Adjustment

The sync function is used to minimize horizontal jittering or tearing at the top to the displayed image.

Highlight **SYNC** with the control disk and press **ENTER** to toggle between **FAST** and **SLOW**.

Note: SYNC is normally used in the SLOW position. The FAST position is used to compensate for unsteady sync pulses from older video playback equipment.

Hint : when the line doubler feature is ON (active), toggle the sync to FAST.

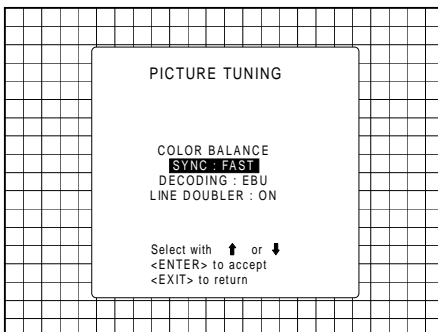

ENTER will toggle Sync between **FAST** and **SLOW**

EXIT will return to the Random Access Adjustment menu.

RANDOM ACCESS ADJUSTMENT MODE

Line Doubler

Line doubling is only possible for Video, S-Video or Component Video images on standard line frequency.

To eliminate the video line patterns and to improve the image stability, the line doubler has to be switched on. The line doubler is default set in the ON position when starting up for the first time. The setting of the line doubler will be saved together with the source number. Each time this source number is selected, the last saved version will be loaded.

Highlight *Line Doubler* with the control disk and press **ENTER** to toggle between *ON (active)* and *OFF (non active)*.

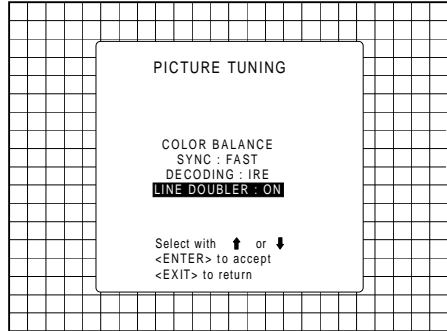

ENTER will toggle Sync between FAST and SLOW
EXIT will return to the Random Access Adjustment menu.

Enhanced Blue On/Off Adjustment

Highlight *ENHANCED BLUE* by pushing the control disk up or down and press **ENTER** to toggle between *ON* and *OFF*. (only available when RGB signals are connected)

When 'Enhanced Blue' is ON, the blue color will be displayed as cyan.

Note: Enhanced blue is only used when an RGBs or RGsB analog signal from a computer is being displayed. Enhanced blue is not recommended for non computer generated images.

For displaying graphics, this 'Enhanced Blue' function could falsify the color reproduction. In this case, put Enhanced Blue OFF.

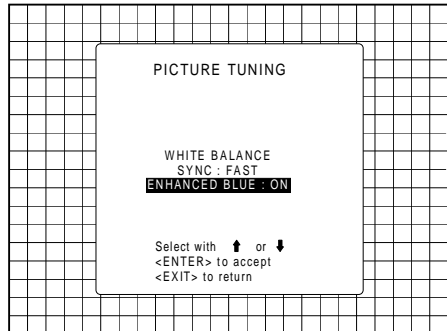

ENTER will toggle Enhanced Blue between ON and OFF
EXIT will return to the Random access main menu.
ADJUST returns to operational mode

Color Select

Highlight *COLOR SELECT* by pushing the control disk up and down and press **ENTER** to display the color select menu.



ENTER continues to the color select menu
EXIT will return to Internal Crosshatch Selection or Setup Pattern Selection Menu
ADJUST returns to operational mode

Use the control disk to highlight a color (CRT) or combination of colors to display the projected image in that specific color.

To select a new color, press **ENTER**, the color selection menu appears again on the screen. To terminate the color select procedure, press **EXIT**.

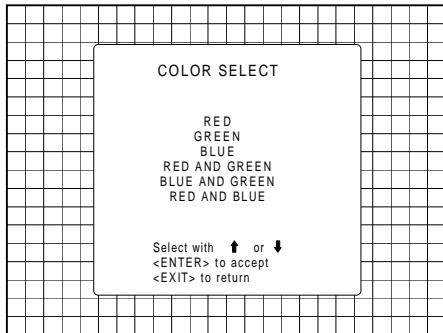

ENTER continues with the selected color or color combination.
EXIT returns to the Random access main menu.

RANDOM ACCESS ADJUSTMENT MODE

Geometry Adjustments

The geometry adjustments have to be done only on the green image. These adjustments are automatically implemented for the other color images : Left-right (EW) and Top-Bottom corrections, blanking, Horizontal amplitude, vertical amplitude, vertical linearity and Horizontal phase.

Highlight **GEOMETRY** by pushing the control disk up or down and press **ENTER** to display the geometry menu.

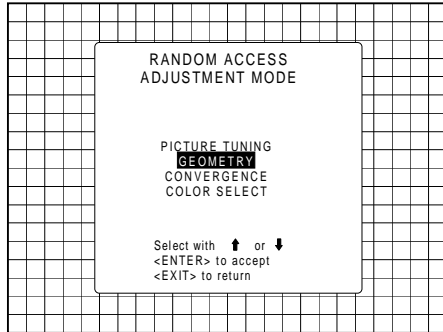

ENTER will display Geometry menu
EXIT will return to Internal Crosshatch Selection or Setup Pattern Selection Menu
ADJUST returns to operational mode

Within the geometry adjust menu, the following adjustments are available :

- horizontal phase (not for internal # pattern).
- raster shift
- left-right corrections
- top-bottom corrections
- horizontal size
- vertical linearity
- vertical size
- blanking

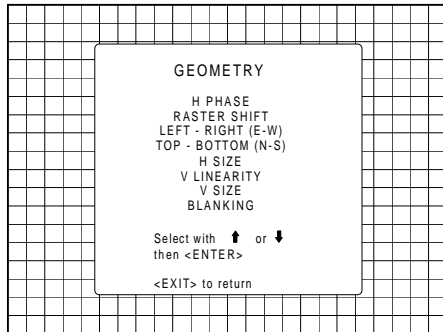

ENTER will display the selected option
EXIT will return to Random Access Adjustment Mode main menu
ADJUST returns to operational mode

The convergence corrections are disabled during geometry corrections. The blanking corrections are only enabled during the blanking adjustments.

Horizontal Phase Adjustment

Push the control disk up or down to highlight *H PHASE* on *Geometry menu* and then press **ENTER**.

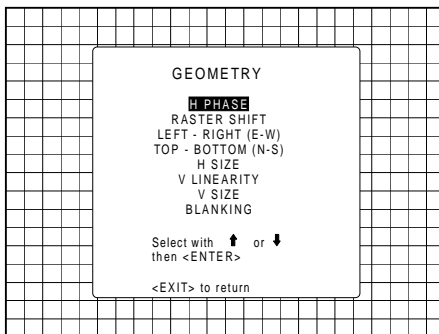

ENTER will select the horizontal phase adjustment.

EXIT returns to the Random access adjustment main menu.

ADJUST returns to operational mode.

Note : No horizontal phase adjustment is available on the internal # pattern.

For external sources :

If the raster shift is correctly adjusted, the text box H phase is projected in the middle of the raster. At that moment, the >< indicates the middle of the raster.

Adjust the hor phase control until the middle of the projected image is equal with the middle of >< .

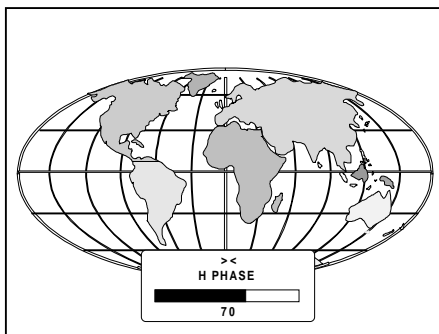

ENTER continues to geometry menu .

RANDOM ACCESS ADJUSTMENT MODE

Note :

- if the genlocked pattern was selected, the external source will be displayed.

A bar scale and a number indicator (between 0 and 100) on the screen give a visual indication of the horizontal phase adjustment.

Correct by pushing the control disk to the right.

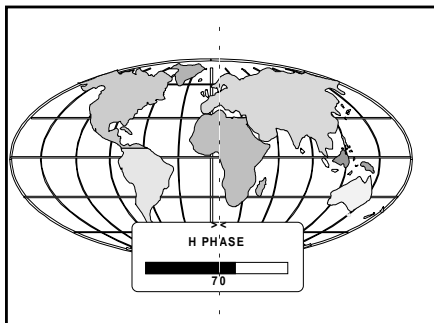

Correct by pushing the control disk to the left.

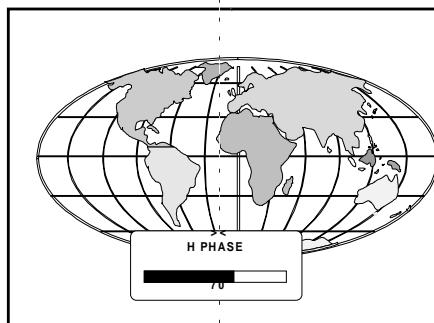

Raster Shift Adjustment

The green raster must be centered both horizontally and vertically on the center of the CRT surface. To center the green raster, look into the green lens and use the control disk to move the raster.

CAUTION

It is necessary to look into the lenses to perform these adjustments. To avoid eye discomfort while looking into the lenses, reduce the contrast and gradually increase the brightness level until the raster becomes visible on the face of the CRT.

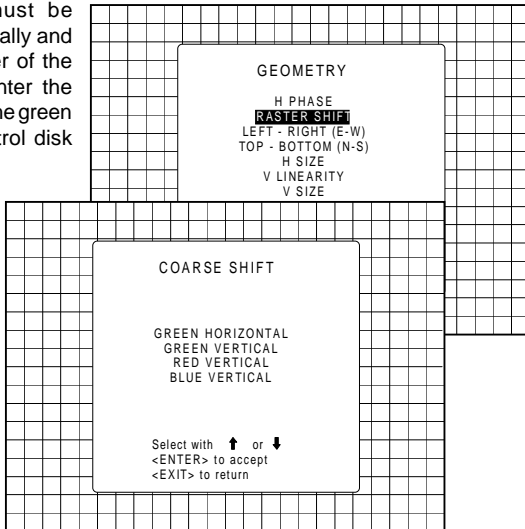

Warning : In order to ensure maximum CRT longevity and to avoid CRT damage, do not shift the raster outside the phosphor area of the CRT.

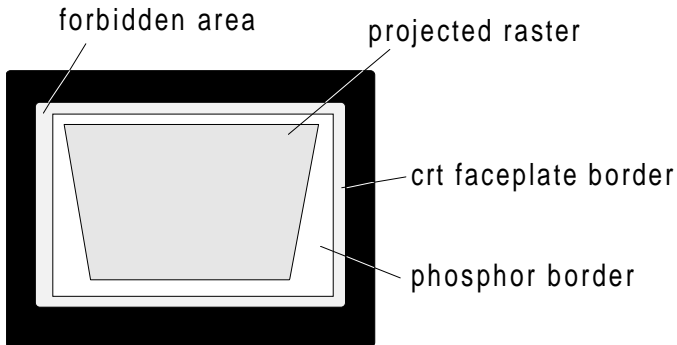

To start the adjustment, use the arrow keys to highlight Raster shift and press **ENTER** to display the coarse shift menu. Select 'Green horizontal' and adjust for correct raster position in horizontal direction on the phosphor. Continue with 'Green vertical', then with 'Red vertical' and with 'Bleu vertical' until the rasters of the 3 tubes correctly centered on the phosphor.

RANDOM ACCESS ADJUSTMENT MODE

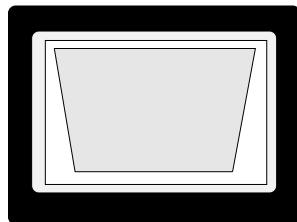

— correct raster position

— wrong raster position

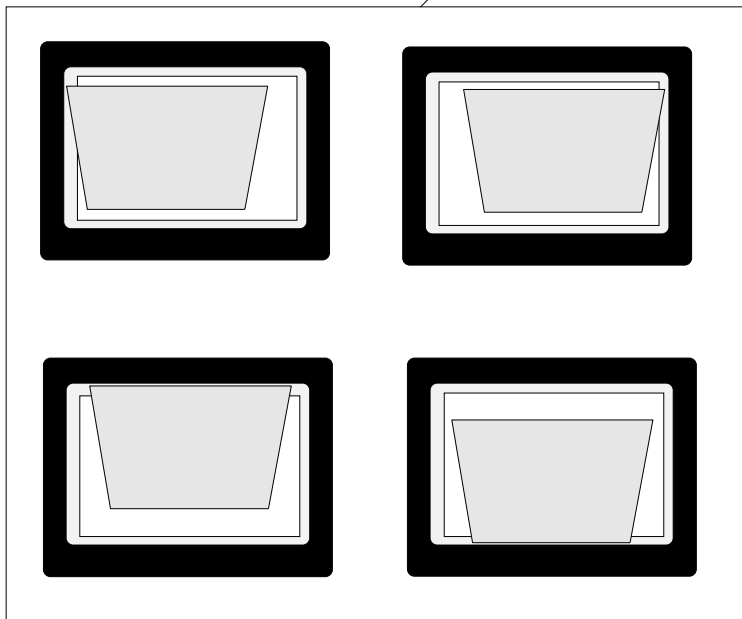

Press **EXIT** to return to the Geometry menu.

Note : Horizontal and Vertical shifts for Red and Blue should be end up with a setting close to 50%. If these settings are significantly greater or lesser than 50%, then contact a BARCO authorized service technician.

Left-Right (east-west) Adjustments

Left-right and center adjustments affect only the vertical lines of the projected image.

To start up the left-right and center adjustments, follow the next procedure :

Push the control disk up or down to highlight *LEFT-RIGHT (E/W)* on the geometry menu and then press **ENTER**.

The diagram illustrates the menu navigation process. It features a grid background with two overlapping menu boxes. The top box is titled "GEOMETRY" and lists several options: H PHASE, RASTER SHIFT, LEFT - RIGHT (E-W) (highlighted with a black background), TOP - BOTTOM (N-S), H SIZE, V LINEARITY, V SIZE, and BLANKING. Below the list, it says "Select with ↑ or ↓ then <ENTER>" and "<EXIT> to return". The bottom box is titled "LEFT-RIGHT" and lists: V CENTERLINE BOW, V CENTERLINE SKEW, RIGHT BOW, RIGHT KEystone, LEFT BOW, and LEFT KEystone. Below this list, it says "Select with ← or → then <ENTER>" and "<EXIT> to return". To the right of these boxes is a rounded rectangular callout box containing the text: "ENTER will select Left-Right adjustment menu", "EXIT returns to random access adjustment mode main menu.", and "ADJUST returns to operational mode".

Only the green image is displayed while making left-right adjustments. The red and blue images will automatically be corrected in the same manner. Convergence corrections are automatically disabled for the duration of these adjustments.

The following adjustments can be executed

- vertical centerline bow
- vertical centerline skew
- side keystone (left - right)
- side bow (left - right)

All adjustment are indicated on the screen with the function name, a bar scale and a number between 0 and 100. See next example "V Centerline Bow"

The diagram shows a grid background with a small rectangular box in the bottom right corner. The box is titled "V CENTERLINE BOW" and contains a horizontal bar scale. The bar is filled with black and has the number "70" centered below it.

RANDOM ACCESS ADJUSTMENT MODE

Adjust the next alignments until the vertical lines are straight.
 To enter an alignment, push the control disk up or down to highlight a function and press **ENTER** to activate this function.
 Press **EXIT** to return.

LEFT-RIGHT
 V CENTERLINE BOW
V CENTERLINE SKEW
 RIGHT BOW
 RIGHT KEYSTONE
 LEFT BOW
 LEFT KEYSTONE

Select with ← or →
 then <ENTER>

<EXIT> to return

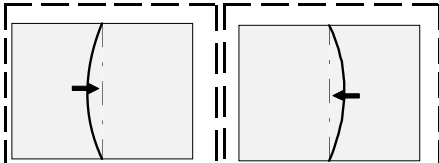

Corrects for curvature of the vertical lines in the middle of the image.

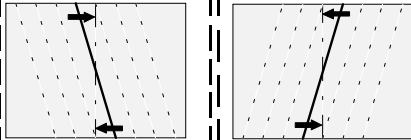

Corrects the tilting of the vertical lines in the middle of the image.

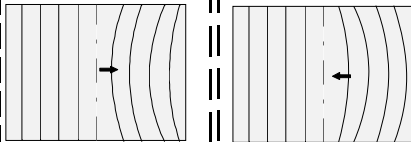

Corrects for curvature of the vertical lines on the right side

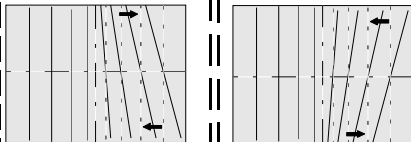

Corrects the keystone geometry correction of the vert. lines on the right side

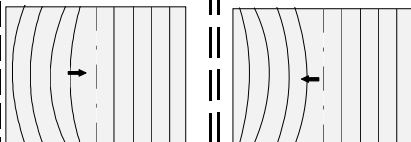

Corrects for curvature of the vertical lines on the left side

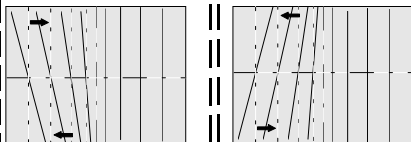

Corrects the keystone geometry correction of the vert. lines on the left side

Correct by pushing the control disk to the right

Correct by pushing the control disk to the left

Top-Bottom (north-south) Adjustments

Top-Bottom and center adjustments affect only the horizontal lines of the projected image.

To start up the Top-Bottom and center corrections, follow the next procedure :

Push the control disk up or down to highlight **TOP-BOTTOM (N/S)** on the geometry menu and then press **ENTER**.

The diagram illustrates the menu navigation process. It shows two overlapping menu boxes on a grid background. The top box is the 'GEOMETRY' menu with the following items: H PHASE, RASTER SHIFT, LEFT - RIGHT (E-W), **TOP - BOTTOM (N/S)** (highlighted), H SIZE, V LINEARITY, V SIZE, and BLANKING. Below these items, it says 'Select with ↑ or ↓ then <ENTER>' and '<EXIT> to return'. The bottom box is the 'TOP - BOTTOM' menu with the following items: H CENTERLINE BOW, H CENTERLINE SKEW, TOP BOW, TOP KEYSTONE, BOTTOM BOW, and BOTTOM KEYSTONE. Below these items, it says 'Select with ↑ or ↓ then <ENTER>' and '<EXIT> to return'. To the right of the 'TOP - BOTTOM' menu, there is a callout box containing the text: 'ENTER will select Top-Bottom adjustment menu', 'EXIT returns to random access adjustment mode menu.', and 'ADJUST returns to operational mode'.

Only the green image is displayed while making top-bottom adjustments. The red and blue images will automatically be corrected in the same manner. Convergence corrections are automatically disabled for the duration of these adjustments.

The following adjustments can be executed :

- horizontal centerline bow
- horizontal centerline skew
- top bow
- top keystone
- bottom bow
- bottom keystone

All adjustment are indicated on the screen with the function name, a bar scale and a number between 0 and 100. See next example "H Centerline Bow"

The diagram shows a grid background with a small box in the bottom right corner. The box is titled 'H CENTERLINE BOW' and contains a horizontal bar scale. The scale is a black bar that is approximately 70% full, with the number '70' centered below it.

RANDOM ACCESS ADJUSTMENT MODE

Adjust the next alignments until the vertical lines are straight.
 To enter an alignment, push the control disk up or down to highlight a function and press **ENTER** to activate this function. Press **EXIT** to return.

- TOP - BOTTOM
 - H CENTERLINE BOW
 - H CENTERLINE SKEW
 - TOP BOW
 - TOP KEYSTONE
 - BOTTOM BOW
 - BOTTOM KEYSTONE
- Select with ↑ or ↓
 then <ENTER>
- <EXIT> to return

Corrects for curvature of the horizontal lines in the middle of the image.	
Corrects the tilting of the horizontal lines in the middle of the image.	
Corrects for curvature of the horizontal lines on the upper side	
Corrects the keystone geometry correction of the hor. lines on the upper side	
Corrects for curvature of the horizontal lines on the lower side	
Corrects the keystone geometry correction of the hor. lines on the lower side	
Correct by pushing the control disk down	Correct by pushing the control disk up

RANDOM ACCESS ADJUSTMENT MODE

Horizontal Size Adjustment

Push the control disk up or down to highlight **H SIZE** on the Geometry menu and then press **ENTER**.

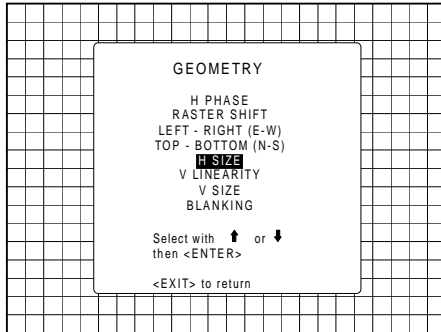

ENTER will select horizontal size adjustment
EXIT returns to random access adjustment mode menu.
ADJUST returns to operational mode

Adjust the horizontal size by pushing the control stick to the right or to the left until the exact image width is obtained.

Note :

- if the internal # pattern was selected, this pattern remains on the screen.
- if the genlocked pattern was

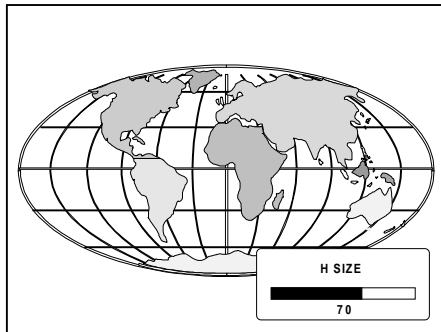

H size too large

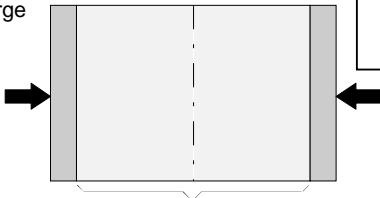

Ideal image size

H size too small

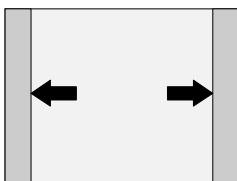

selected, the external source will be displayed.

A bar scale and a number indicator give a visual indication of the horizontal size adjustment.

Hint : In order to avoid loss of resolution in the projected image and to ensure maximum CRT longevity, do not use an excessively small horizontal size setting.

EXIT will return to Geometry

RANDOM ACCESS ADJUSTMENT MODE

Vertical Linearity Adjustment

The vertical linearity adjustment function corrects for vertical non-linearities which extend from the center of the image to the top and bottom of the image.

Push the control disk up or down to highlight *V LINEARITY* on the Geometry menu and then press **ENTER**.

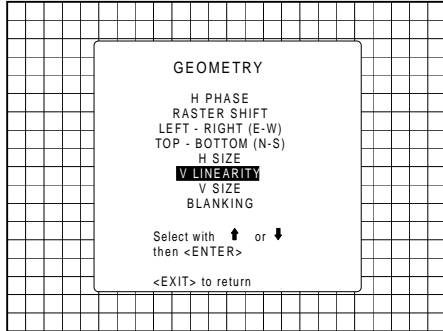

ENTER will select vertical linearity adjustment

EXIT returns to random access adjustment mode menu.

ADJUST returns to operational mode

Adjust the vertical linearity with the control disk until the distances between the horizontal lines of the set up pattern are equal.

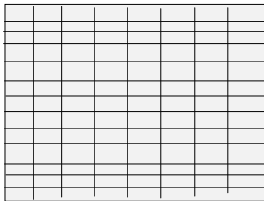
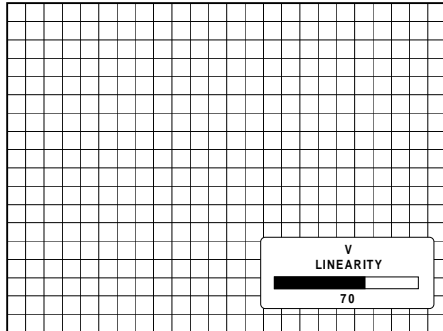

EXIT will return to the Geometry menu

Vertical Size Adjustment

Push the control disk up or down to highlight *V SIZE* on the Geometry menu and then press **ENTER**.

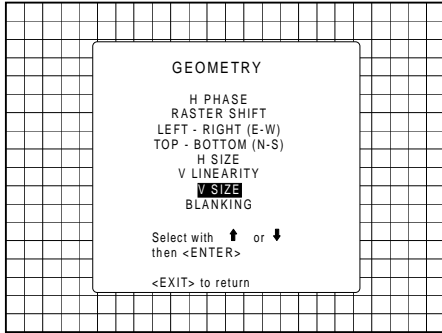

ENTER will select vertical size adjustment
EXIT returns to random access adjustment mode menu.,
ADJUST returns to operational mode

Adjust the vertical size by pushing the control disk up or down until the exact image height is obtained.

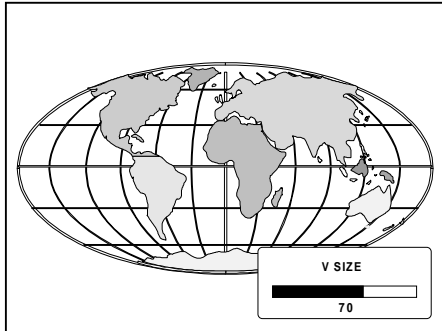
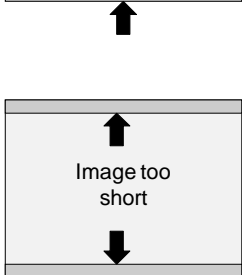
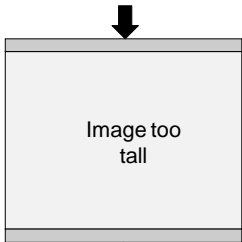

Note :

- If the internal # pattern was selected, this pattern remains on the screen.
- If the genlocked pattern was selected, the external source will be displayed.

A bar scale and a number indicator give a visual indication of the vertical size adjustment.

Hint : In order to avoid loss of resolution in the projected image and to ensure maximum CRT longevity, do not use an excessively small vertical size setting.

EXIT will return to Geometry.

RANDOM ACCESS ADJUSTMENT MODE

Blanking Adjustments

Blanking adjustments affect only the edges of the projected image and are used to frame the projected image on to the screen and to hide or black out unwanted information (or noise). A 0% on the bar scale indicates no blanking.

To start up the Blanking adjustments, follow the next procedure :

Push the control disk up or down to highlight *BLANKING* on the Geometry menu and then press **ENTER**.

GEOMETRY

H PHASE
RASTER SHIFT
LEFT - RIGHT (E-W)
TOP - BOTTOM (N-S)
H SIZE
V LINEARITY
V SIZE
BLANKING

Select with ↑ or ↓
then <ENTER>

<EXIT> to return

BLANKING

TOP
BOTTOM
LEFT
RIGHT

Select with ↑ or ↓
then <ENTER>

<EXIT> to return

ENTER will select blanking adjustment menu.
EXIT returns to random access adjustment mode menu.
ADJUST returns to operational mode

The following blanking corrections are possible :

- Top blanking
- Bottom blanking
- Left blanking
- Right blanking

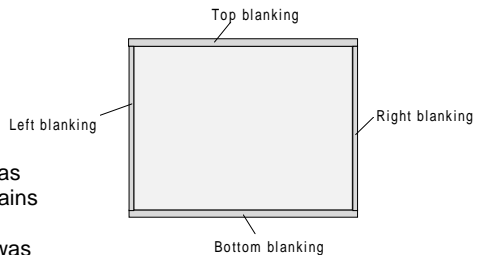

Therefore :

- If the internal # pattern was selected, this pattern remains on the screen.
- If the genlocked pattern was selected, the external source will be displayed.

RANDOM ACCESS ADJUSTMENT MODE

Adjust the next blanking alignments until the image is correctly framed or the unwanted information is blanked out.

To enter a blanking alignment, push the control disk up or down to highlight a function and press **ENTER** to activate this function.

Press **EXIT** to return.

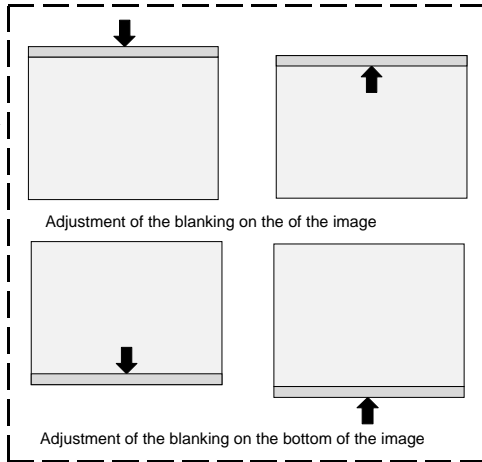
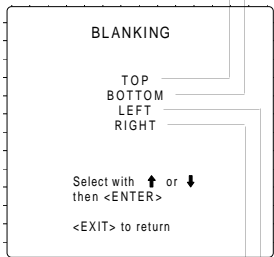

Correct by pushing the control disk up or down.

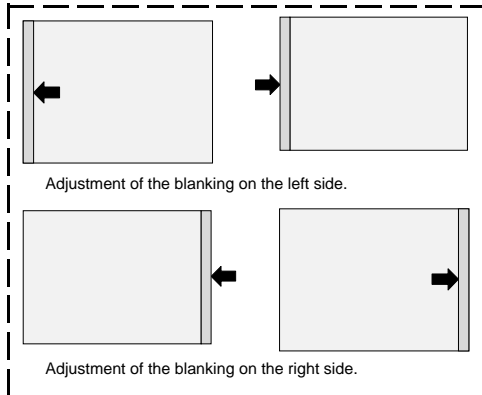

Correct by pushing the control disk to the right or to the left.

RANDOM ACCESS ADJUSTMENT MODE

Convergence Adjustment

Convergence adjustments affect both the horizontal and vertical lines of the setup pattern. These adjustments are performed on the red image while superimposed on the green image and then on the blue image while superimposed on the green image.

Note : the green convergence adjustments can be added as an option. When these are available, start always with 'green only'. This option will also be indicated on the convergence menu.

Highlight first 'Green only' when available by pushing the control disk up or down and press **ENTER** to display the convergence adjustment menu

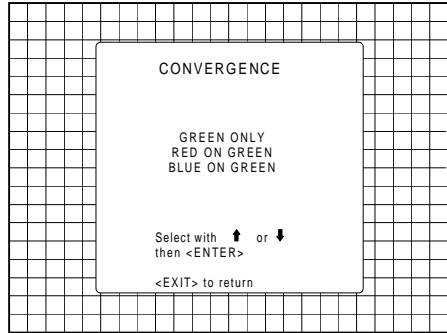

ENTER will display the Convergence menu.

EXIT will return to Random Access Adjustment Mode main menu.

ADJUST returns to operational mode.

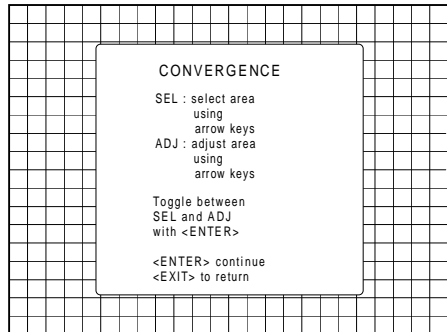

ENTER will continue to convergence adjustment

EXIT returns to convergence menu.

RANDOM ACCESS ADJUSTMENT MODE

The screen area is divided into 25 areas. Use the control disk to move the box to the desired zone and then press **ENTER** to begin the convergence adjustment. Start the convergence adjustment with zone one and continue as mentioned in the diagram hereafter.

25	23	9	15	17
24	22	8	14	16
5	4	1	2	3
20	18	6	10	12
21	19	7	11	13

397

Use the control disk to make horizontal or vertical convergence adjustments in the selected zone and then press **ENTER** to move the box to another zone or **EXIT** to return to the Convergence menu.

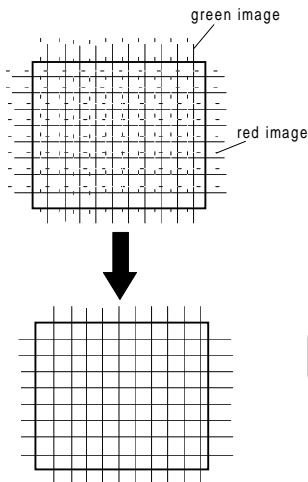
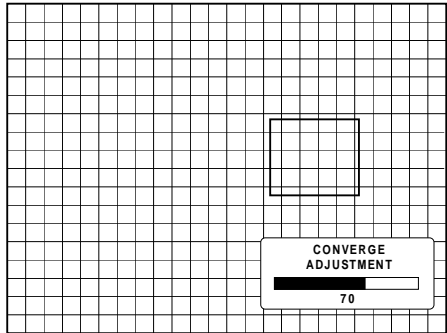

ENTER toggles the control disk between zone selection and zone adjustment .
EXIT returns to convergence menu

SERVICE MODE

Starting up the service mode

Overview flow chart Service mode

Projector Set Up

Memory Management

Common Settings

I2C Diagnostics

Starting up the Service mode.

Use the control disk to highlight 'Service' and then press **ENTER**.

Some items in the Service mode are password protected (when the password function is active). Enter your password to continue. All other password protected items are now also free available if you stay in the adjustment mode.

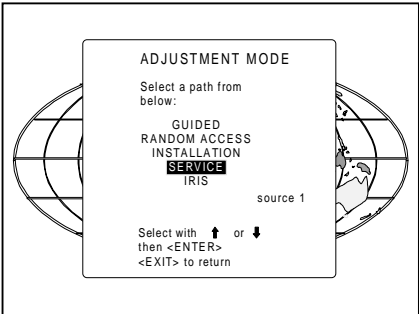

ENTER continues to the Service Mode main menu.
EXIT returns to the Operational mode.

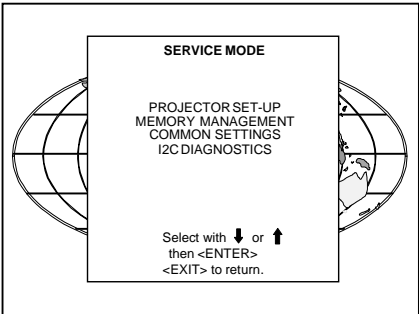

SERVICE MODE

Overview flowchart 'Service' mode.

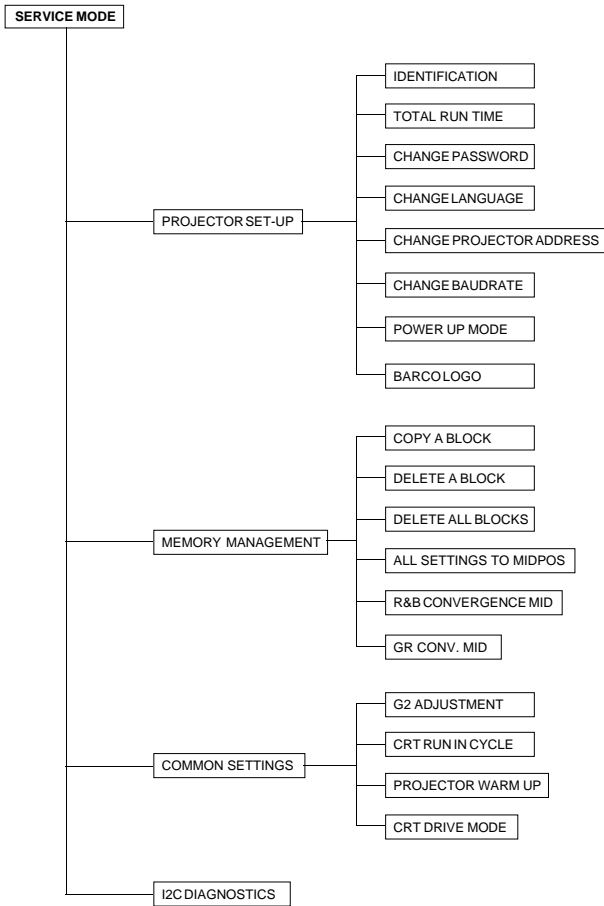

Projector Set-up

Highlight 'Projector Set-Up' by pushing the control disk up or down and press **ENTER** to display the projector set-up menu.

Within the projector set-up menu, the following items can be consulted or set to the desired setting :

- Identification
- Total run time
- Change password
- Change language
- Change projector address
- Change baudrate
- Power up mode
- BARCO logo

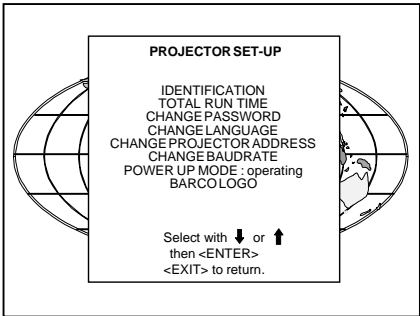
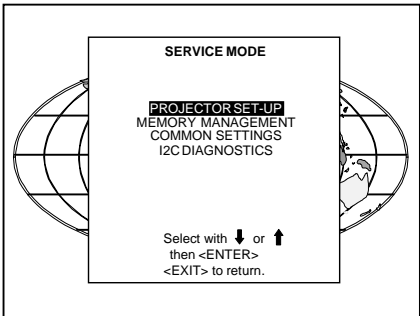

Identification

Highlight 'Identification' with the control disk and press **ENTER**.

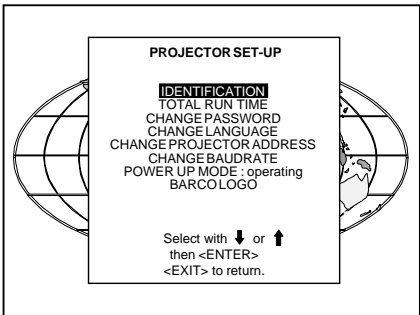

ENTER will start the selected item.
EXIT returns to the Service mode menu.

SERVICE MODE

The 'Identification' screen gives information concerning :

- Projector address. To change the address of your projector, contact a qualified service technician.
- Software version.
- Configuration.
 - Possible installations :
 - * Front-ceiling
 - * Front-table
 - * Rear-ceiling
 - * Rear-table



- Baud rate PC : transfer speed for communication with an IBM PC (or compatible) or MAC. The baud rate of the projector must be the same as the baud rate of the connected computer. When there is a difference, contact a qualified service technician to make the appropriate changes.
- Text ON/OFF
Indicates in operational mode if the bar scale and number indicator will be displayed and if warnings and failures will be displayed.
ON : displayed
OFF : not displayed

The status can be changed by pressing the 'TEXT' key once on the RCU.

- Serial no. : indicates the fabrication number of the projector. This number can be useful when calling for technical assistance.

Total Run Time

Highlight '*Total Run Time*' with the control disk and press **ENTER** to display the amount of time the projector has played since its first start up at the factory.

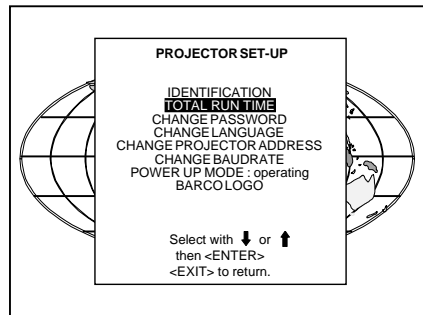

ENTER gives the selected item.
EXIT returns to the Service mode menu.
ADJUST returns to the Operational mode.

Note : all projectors leave the factory after a burn-in period of approximately 100 hours.

Change password

This item is password protected.
Highlight '*Change Password*' with the control disk and press **ENTER**.

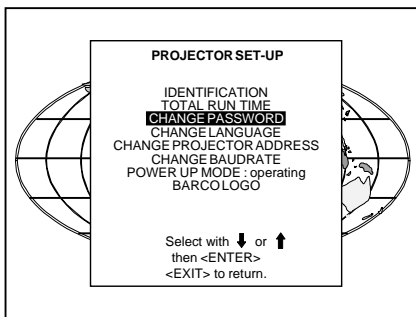

ENTER will display the selected item.
EXIT will return to the Path Selection main menu.
ADJUST will return to the Operational mode.

The current password is displayed. The new password must consist of 4 digits between 0 and 9. Push the control disk to the left or to the right to select the digits to be changed. Use the numeric keys to enter the new digits.

Press **ENTER** to save the new password. Before saving the new password, a confirmation screen will be displayed.

Press **EXIT** to return to the Projector Set-up menu without saving the new password.

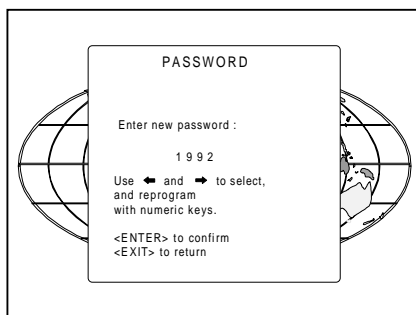

ENTER displays the Confirmation menu.
EXIT returns to the Service mode without saving the new password.

SERVICE MODE

When the displayed password is correct, press **ENTER** to save.
If not correct, press **EXIT** to cancel the saving.

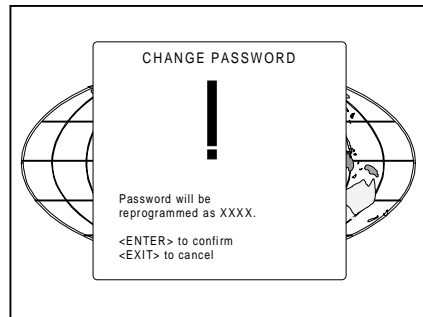

ENTER saves the entered password.
EXIT returns without saving.

Change Language

The 'Change Language' function offers the possibility to change the language of the screen menus to :

- English
- Spanish
- French
- German

Highlight 'Change Language' with the control disk and press **ENTER**.

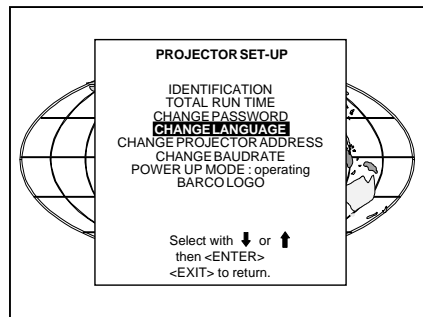

ENTER selects the Change language menu.
EXIT returns to the Service menu.

Push the control disk up or down to select the desired language and press **ENTER** to change the language.

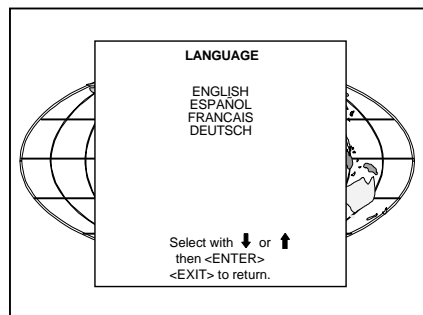

Change Projector Address

Every projector requires an individual address between 0 and 255. This address can be software installed. To change that address, push the control disk up or down to highlight 'Change Porjector Address' and press **ENTER**. The Change Projector Address menu will be displayed and the actual address will be filled in.

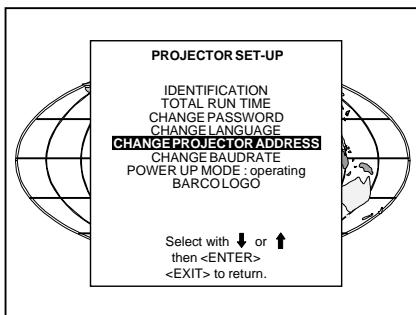

ENTER displays the 'Change Projector Address' menu.
EXIT returns to the Service mode main menu.

The first digit is highlighted. Select the individual digits by pushing the control disk to the right or to the left. Reprogram with the digit keys on the RCU.

Press **ENTER** to confirm.
 Press **EXIT** to return to the projector set up menu.

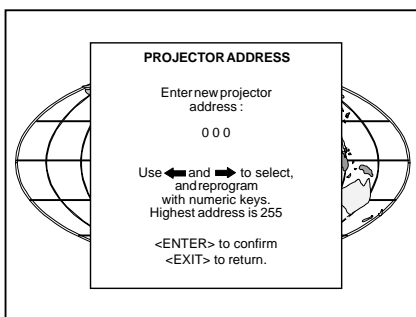

Change baudrate

The communication speed between projector and computer has 8 possible speeds. The baud rate speed can be software set up. Highlight 'Change Baudrate' by pushing the control disk up or down and press **ENTER** to display the Baud rate menu.

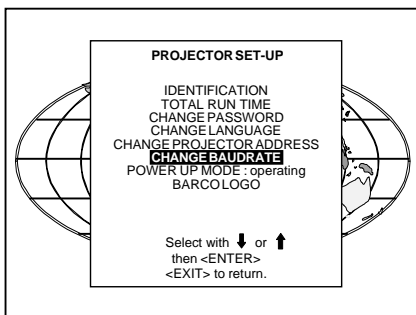

SERVICE MODE

The following baud rates are available :

- 9600
- 4800
- 2400
- 1200
- 600
- 300
- 150
- 110

The actual baud rate will be highlighted. To change the baud rate, push the control disk up or down or to the left or to the right to select the desired baud rate and press **ENTER** to accept this baud rate.

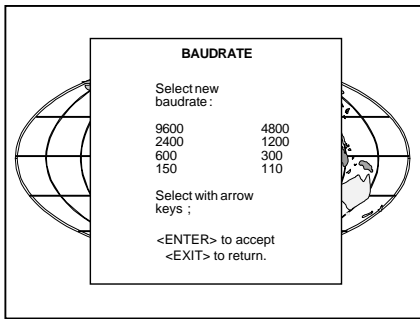

ENTER to accept the selected baud rate.

EXIT to return without changing the baud rate.

Power up mode

When pressing the power switch, the projector can start up in 'operating mode' or in 'stand-by mode'. Operating mode : the projector start up and displays image .

Stand-by mode : the projector start up in stand-by and waits until the stand-by button or a digit key is pressed.

To change the Power up mode, select Power Up mode by pushing the control disk up or down and press **ENTER** to toggle between 'Operating' and 'Standby'.

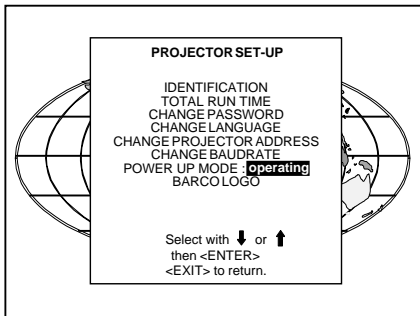

ENTER to toggle between operating and standby.

EXIT to return to the Service menu.

BARCO_logo

The BARCO logo can be added to the image, in overlay or in background, on any place on the screen.

To add the BARCO logo or to change a setting in the BARCO logo menu, highlight 'BARCO logo' by pushing the control disk up or down and press **ENTER** to select.

WARNING : Continuous use of the BARCO logo damages the RED CRT.

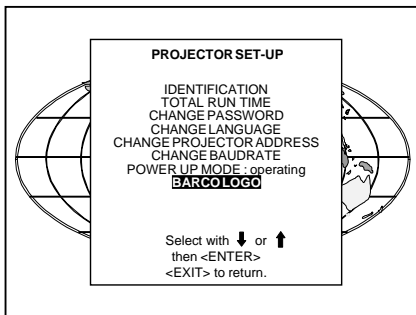

ENTER displays the BARCO logo menu.
EXIT returns to the Service menu

The BARCO logo menu will be displayed on the screen. Within this menu, four toggle settings are available.

Mode [ON/OFF] :

ON : BARCO logo will be displayed on the screen.

To position the logo on the screen, push the control disk up, down, to the left or to the right until the desired position is reached.

OFF : No BARCO logo displayed on the screen.

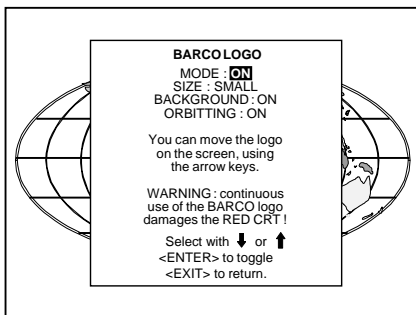

Size [SMALL/LARGE] :

SMALL : Small BARCO logo will be displayed if mode is on.

LARGE : Large (double size) BARCO logo will be displayed if mode is on.

Orbiting [ON/OFF] :

ON : on the BARCO logo will orbit around it axis.

OFF : no orbit of the BARCO logo

Background [ON/OFF] :

ON : BARCO logo will be displayed on a black background.

BARCO

OFF : BARCO logo will be displayed without any background.

BARCO

SERVICE MODE

Memory management

Highlight *'Memory management'* by pushing the control disk up or down and press **ENTER** to display the memory management menu.

Within the memory management menu, the following items can be consulted or executed :

- copy a block
- delete a block
- delete all blocks
- all settings to midposition
- R & B convergence to mid
- Gr convergence mid (only if green convergence is available)

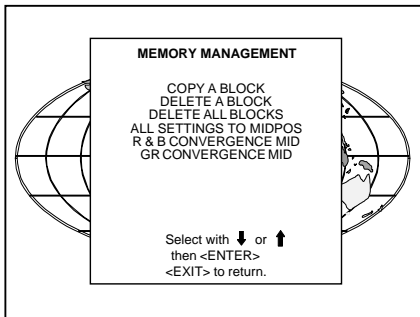
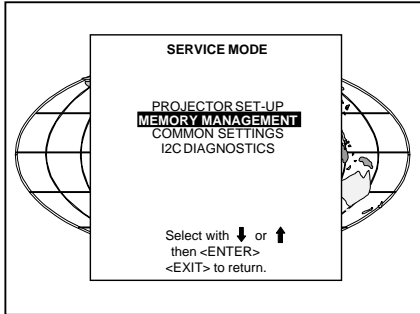

Copy a block

The copy a block function copies the settings of a selected block into the active block.

Highlight *copy a block* with the control disk and press **ENTER**.

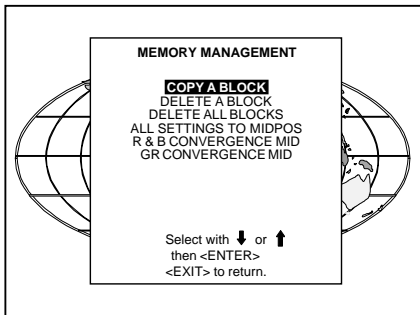

ENTER will select the highlighted item.
EXIT returns to the Path Selection main menu.
ADJUST returns to the Operational mode.

To copy the settings of a closed block to the block you are working on (active block), use the control disk to select a block.

All existing settings will be overwritten with the new settings.

Press **ENTER** to copy the selected block. A confirmation screen will be displayed.

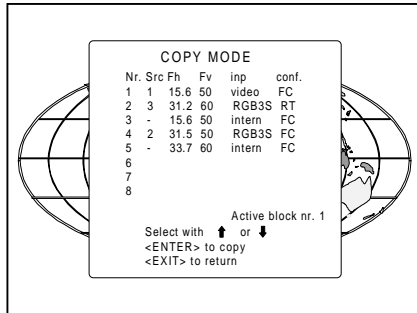

ENTER displays a confirmation screen.
EXIT returns to the Service Mode main menu.

If you are certain you wish to copy the contents of the selected block into the active block, press **ENTER**. **EXIT** cancels the copy procedure and returns without copying the block.

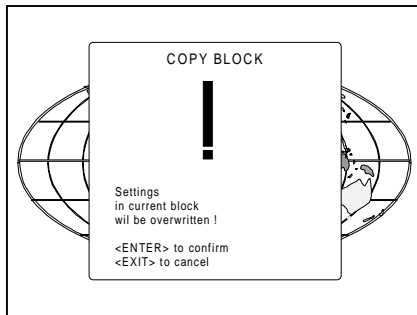

Deletion of blocks

This item is password protected. The delete function is used to clear all data (settings) from an adjustment block.

A delete can be given :

- block by block
- or
- for all blocks.

SERVICE MODE

Deleting block by block

The '*delete a block*' function deletes the settings of a selected block. Highlight '*Delete a block*' with the control disk and press **ENTER**.

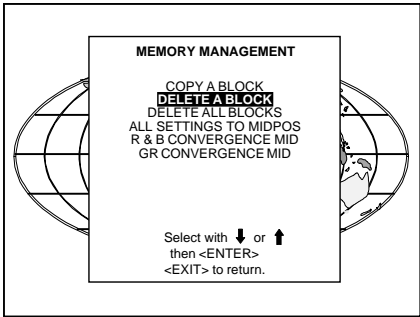

ENTER will select the pointed item.
EXIT returns to the Path Selection main menu.
ADJUST returns to the Operational mode.

Push the control disk up or down to select the desired adjustment block. Press **ENTER** to delete the selected adjustment block. A confirmation menu will be displayed.

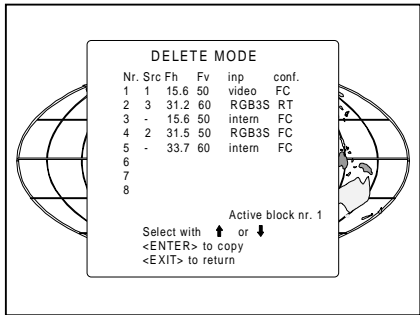

ENTER displays the confirmation menu.
EXIT returns to the Service Mode main menu.

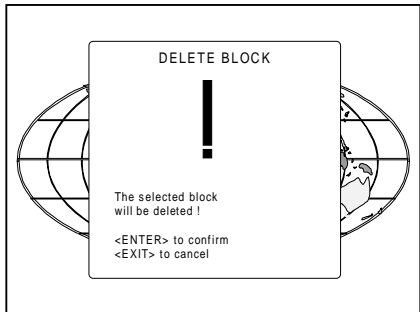

ENTER will delete the selected block.
EXIT cancels the deletion procedure and returns to the Service mode main menu

Deletion of all blocks

Highlight '*delete all blocks*' with the control disk and press **ENTER**.

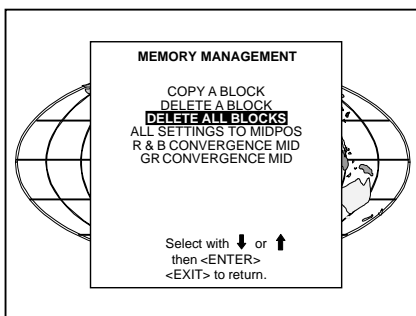

ENTER gives a confirmation message before deleting.

EXIT returns to the Path Selection main menu.

If you are certain you wish to delete all blocks, press **ENTER** to confirm, otherwise press **EXIT** to return. Once **ENTER** is pressed, all block headers and adjustment settings are permanently removed and cannot be restored.

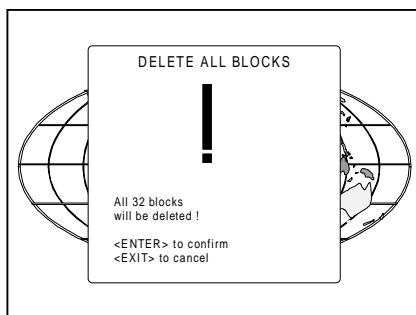

All settings to midposition

Item is password protected. Highlight '*All settings to midposition*' with the control disk and press **ENTER** to set all settings to their midposition. A confirmation menu will be displayed first.

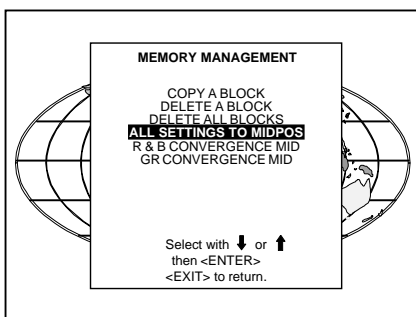

ENTER displays a Confirmation screen.
EXIT returns to the Service menu.

SERVICE MODE

ENTER will set all settings to their midposition. **EXIT** will cancel the operation to set all settings to their midposition.

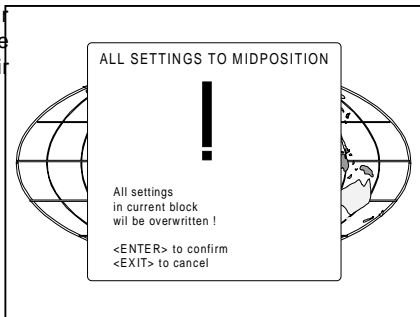

Undo all settings to midpos

When "All settings to midpos" is selected, all settings are set to their midposition. To cancel this action, select 'Undo all settings to midpos' by pushing the control disk up or down and press **ENTER**. 'Undo all settings to Midposition' is displayed in the Memory management menu in stead off 'All settings to midposition' when this latter is pressed.

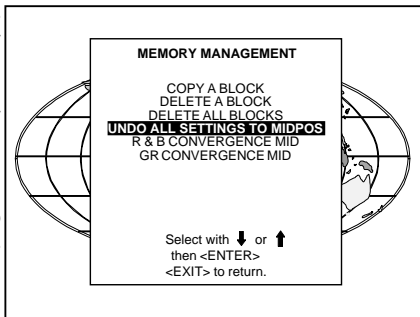

An undo is possible as long as the projector is playing on the same source (= same adjustment block) even when some adjustments as geometry or convergence are already readjusted. When undo is pressed all settings are reset to the previous settings.

R & B convergence mid

Item is password protected. Highlight '*R & B convergence mid*' with the control disk and press **ENTER** to set all convergence settings to their midposition. A confirmation screen will be displayed first.

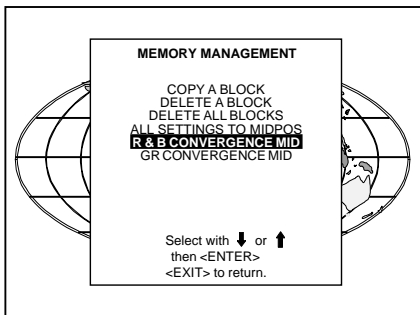

ENTER sets the convergence settings to their midposition. **EXIT** cancels the procedure to set the convergence settings to their midposition.

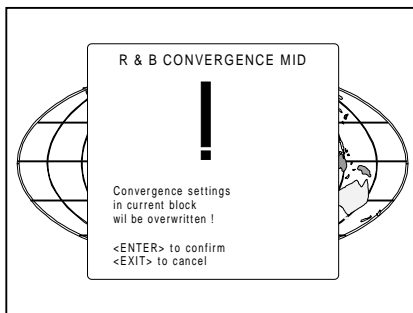

Undo R & B convergence mid

When "R & B convergence mid" is selected, all convergence settings are set to their midposition. To cancel this action, select 'Undo R & B convergence mid' by pushing the control disk up or down and press **ENTER**. 'Undo R & B convergence mid' is displayed in the Memory management menu in stead off 'R & B convergence mid' when this latter is pressed.

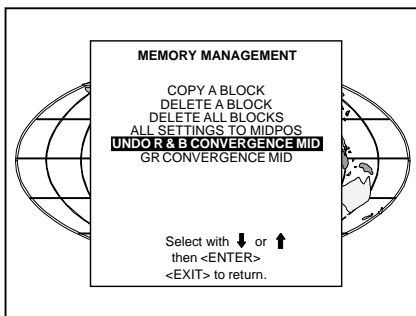

An undo is possible as long as the projector is playing on the same source (= same adjustment block) even when some adjustments are already readjusted. When undo is pressed all settings are reset to the previous settings.

Green convergence mid

Only available when the projector is equipped with green convergence adjustmentes.

Highlight 'Gr convergence mid' by pushing the control disk up or down and press **ENTER** to switch off the green convergence.

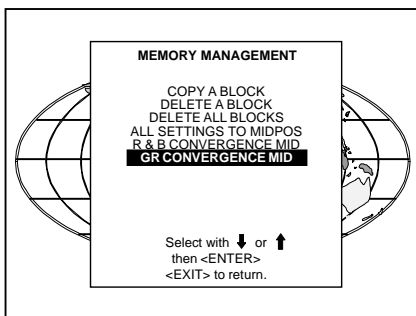

SERVICE MODE

Undo green convergence mid

Only available when the projector is equipped with green convergence adjustments.

The item 'Undo green convergence mid' will automatically be displayed when the green convergence is switched to midposition.

Press **ENTER** to switch on the green convergence.

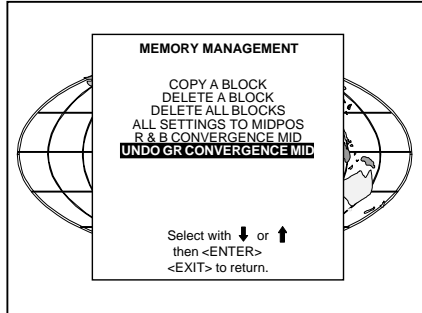

Common Settings

Highlight 'Common settings' by pushing the control disk up or down and press **ENTER** to display the common settings menu.

Within the common settings menu, the following items can be set up or executed :

- G2 adjustment
- CRT run in cycle
- Projector warm up

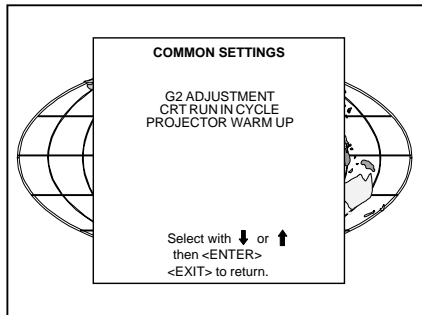
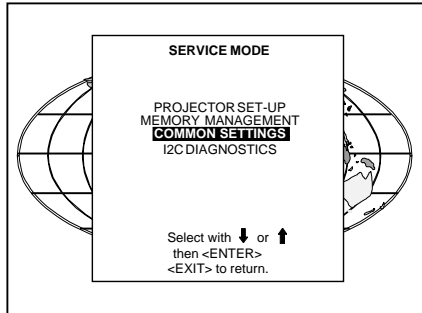

G2 Adjustment

Item is password protected.
Highlight 'G2 adjust' with the control disk and press **ENTER** to continue.

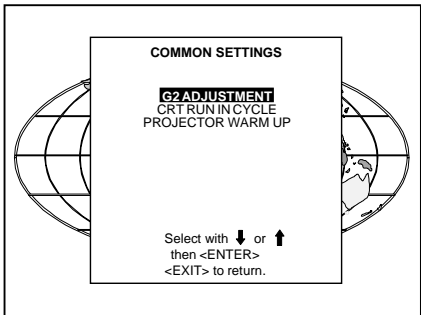

A safety notice will be displayed on the screen as it is necessary to open the top cover to adjust the G2.

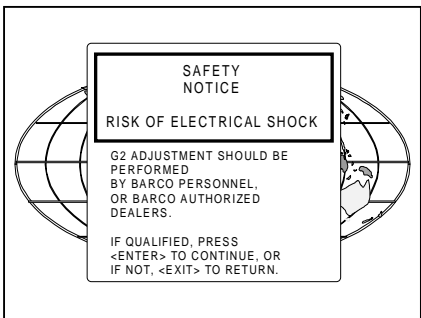

'G2 adjustment should be performed by BARCO personnel, or BARCO authorized dealers'.

If you are qualified, press **ENTER** to continue. If not qualified, press **EXIT** to return to the Common settings menu. Further description of the G2 adjustment is given in the Installation manual.

ENTER selects the G2 adjustment.
EXIT returns to the Common settings menu.
ADJUST returns to the Operational mode.

SERVICE MODE

CRT run in cycle

The CRT run in cycle option can only be activated when memory blocks on an internal # pattern are available. When one or more such blocks are available, a flashing white image (5sec on, 5 sec off) is generated and that for 5 min on the first internal block. In the next 5 min, a second internal block will be used to generate the flashing white image. The image will also be shifted in a vertical way to prevent a CRT burn in. To quit the CRT run in cycle option, press EXIT.

Highlight '*CRT run in cycle*' with the control disk and press **ENTER** to start.

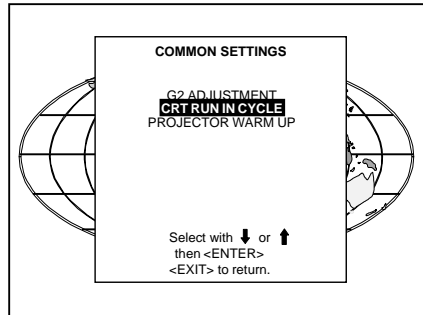

ENTER selects the CRT run in cycle option.
EXIT returns to the Path Selection main menu.

If a memory block adjusted on an internal # pattern is available, the CRT run in cycle will start when pressing ENTER. If no such a block is available, the projector cannot run the CRT run in option and leaves the adjustment mode.

If you still want to run CRT run in cycle, create first a memory block on an internal # pattern and restart the CRT run in option.

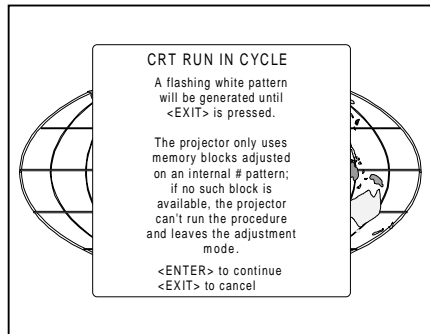

ENTER starts the 'CRT run in' when an internal generated # pattern is available.
EXIT returns to the Path Selection main menu.

Projector warm up

Highlight 'Projector warm up' by pushing the control disk up or down and press **ENTER** to select the projector warm up menu.

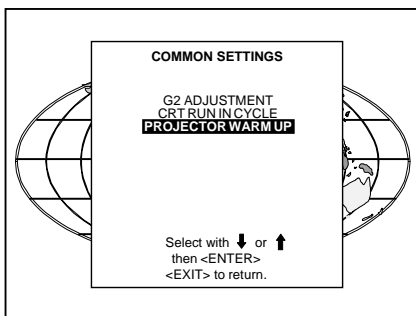

The ON/OFF option can be toggled with the **ENTER** key.

When in the ON position (and the CRT run in cycle is OFF), the projector can start up with a warm up periode of 20 minutes. During the start up a warm up menu will be displayed. This menu offers the possibility to skip the warm up periode anyway by pressing the **EXIT** key and offers the possibility to adjust the horizontal and vertical amplitude of this white image with the control disk. During this warm up periode, a full white image is shifted on the CRT faceplate to avoid a burn in.

Every 30 seconds a text box will be displayed on another place on the screen with the remaining time to go. When **EXIT** is pressed during this warm up periode, the warm up menu will be redisplayed with the remaining time indication. Press another time **EXIT** to interrupt the warm up cycle.

When the warm up option is OFF, when switching on the projector, it starts immediately with the projection of the selected source

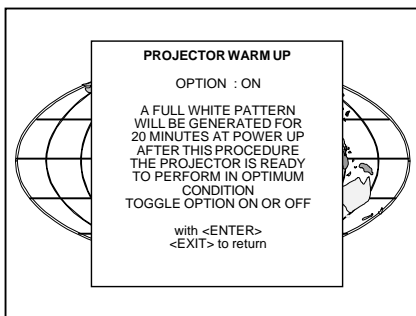

SERVICE MODE

I2C Diagnostics

Highlights 'I2C Diagnostics' by pushing the control disk up or down and press **ENTER**.

The I2C diagnostics menu gives an overview of the I2C failures inside the projector.

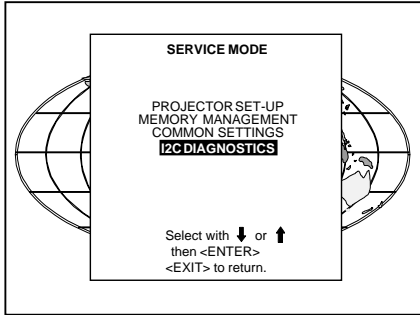

To scroll through the failure list, push the control disk up or down.

The I2C address, IC number and module name will be given in I2C diagnostic menu.

When no errors are detected, the following message will appear on the screen :

"No errors on i2c-bus detected".

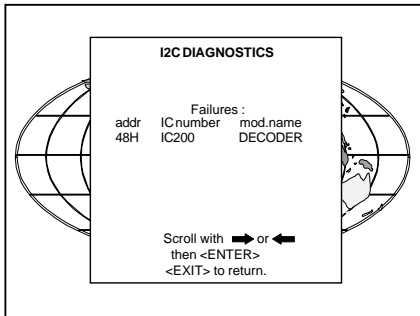

MESSAGES, WARNINGS AND FAILURES

MESSAGES, WARNINGS AND FAILURES

INPUT 01
Fh= 15.6 kHz
Fv= 050 Hz

When selecting a new source, information about this source will be displayed on the screen. Source number, horizontal and vertical frequencies of the displayed source.

SOURCE 01

Announcement of the selected source.

enter
password
x x x x

Message to enter your password. Password contains 4 digits.

text on

These messages will be displayed on the screen when pushing the TEXT key.

Text ON : the '*bar scale indication*' will be enabled during the change of an analog control in the '*operational mode*' + all warnings and failures will be displayed.

text off

Text OFF : the '*bar scale indication*' will be disabled during the change of an analog control in the '*operational mode*' + all warnings and failures will not be displayed.

PROJECTOR
ADDRESS :
003

Indication of the projector address when activating the '*ADDRESS*' button on the RCU with a pencil or other small object.

WARNING :
input not
available

When using the projector with the RCVDS, this warning will be displayed when selecting an input slot of an RCVDS where the input board is missing.

MESSAGES, WARNINGS AND FAILURES

WARNING : source not available	The input is a valid input but the source is not connected to the input terminals or the input source is switched off.
WARNING : invalid key entry	When a wrong key is pressed on the RCU.
WARNING : invalid code entry	Message when the entered password is wrong.
WARNING : end of adjustment range	End of adjustment range.
WARNING : input no longer available	Message will be displayed when the input source is no longer available. The following message then appears: <i>'check input signal or select new source'</i> .
check input signal or select new source	Message will be displayed after the message <i>'input no longer available'</i> . It asks to check the connections between the source and the projector or to check if the source is switched on.
WARNING : input selector not available	It warns you to check the power connection or the power status of the RCVDS. Next message will appear immediately on the screen: <i>'go to stand-by'</i> .

MESSAGES, WARNINGS AND FAILURES

WARNING :

**go to
stand by**

Projector will switch to 'stand-by' when the RCVDS is no longer available.

WARNING :

**invalid
frequency
input**

The entered frequency or applied frequency of the source is out of the projector's range.

**table is
deleted**

Message to inform that selected table is deleted. This message will be followed by 'confirm message', on which the user has to answer.

FAILURE

**I2C error
addr. : 7FH3**

Hardware failure. Call a qualified service technician for repair.

**FAILURE
short
circuit on
I2C bus**

Hardware failure. Call a qualified service technician for repair.

**FAILURE
RCVDS com-
munication
error**

Serial communication error between the RCVDS and the projector.

**FAILURE
IRIS commu-
nication
error**

Communication error between IRIS 800 and the projector. Call a qualified service technician.

**WAIT
starting
up
IRIS**

Message during the start up of the IRIS 800. Message will disappear when the IRIS 800 is ready to accept commands.

OPTIONS

IR receiver 800

Hardwired RCU

Projector Control software

RCVDS 05

VS05

Adapter and communication cables

Ceiling mount CM50

Soft edge matching

Contrast modulation

Picture Orbiting

IR Receiver 800

This infrared receiver unit makes it possible to control the projector from another room.

There is a communication line with cable between the IR receiver and the projector or the RCVDS05. The control information from the RCU can now be sent to this IR receiver.

The IR receiver 800 displays the selected source on a 7-segment display.

Order number : R9827515.

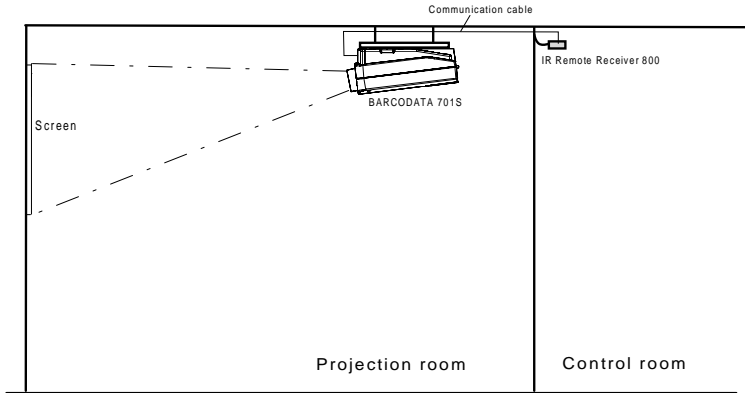

Hardwired RCU.

The control signals from the RCU can be sent to the projector via a wired connection.

Preparing your remote cable :

Use a shielded cable with a maximum length of 100 m and two mini-jack 3.5 mm connectors (order number : R313043).

- Peel back the vinyl covering of the cable on both sides and twist the wire core.
- Solder a jack plug as shown in drawing above to each end of the cable.

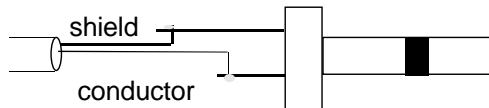

shield = ground

conductor = data information

When the cable is ready, plug one side in the remote control and the other side in the connector on the rear of the projector labelled 'remote'.

Projector Control software

Only available for projectors equipped with the optional RS232 communication port.

The software is user-friendly and makes full use of : mouse control, pull down menus and dialog boxes.

Two main applications are available with this software : remote control and transferring and receiving data of projector settings.

remote control simulation. Advantage : address range 0 to 15.

adjustment data : where can it be located when an IBM PC (or compatible) or MAC or Workstation is connected :

- hard memory device with files of settings.
- the contents of the local memory of the computer.
- the contents of the projector.

RCVDS 05

An optional RCVDS 05 source selector makes it possible to connect up to 20 sources to the projector. When RCVDS's are linked via the expansion module, even 90 inputs can be connected to the projector.

The selected source number will be displayed on a 2 digit display and the selected input module will be indicated with a LED on the rear.

VS05

The VS05 is a versatile Video and HDTV source selector for all BARCO's digitally controlled large screen projectors. It offers the possibility to connect and switch up to 5 different Video sources, 3 different S-Video sources and 1 RGB Analog source to a BARCO projector. In addition, the audio signal proper to the source, can be switched to an audio amplifier.

Adapter and communication cables

BARCO provides several cables to connect peripheral equipment to the projector.

a. D9-D9 communication cable

- To connect an IBM PC (or compatible) to the projector. (only if the optional RS232 port is installed.)
- To connect an RCVDS to the projector.
- To connect an IR receiver to the RCVDS05 or to the projector.
- To be used as extension cable for all other adapter cables.

Available length :5 m (16ft), order number R982770; 15 m(50ft), order number R9827560; and 30 m (100ft), order number R9827570

b. Din Mini8-D9 adapter cable.

- To connect a Macintosh computer to the projector.
Available length : 1 m, order number R9827640.

c. D25-D9 adapter cable

- To connect a workstation to the projector.
Available length : 1 m, order number R9827630

Ceiling mount CM50

This suspension system enables to mount any projector from the BARCO 700 series to the ceiling without using any mechanical interface, and to adapt the projector perfectly to the local mounting requirements.

Order number CM50 with pulley : R9827990

Order number CM50 without pulley : R9827991.

Orbiting Kit

Static pictures are very often shown on large screen projectors, especially in process control and presentation applications. Due to the fact that the same picture information is shown for a long period in the same place, picture tubes can be damaged by 'local burn-in'. To avoid this problem, a special Orbiting circuit is available which moves the picture very slowly around a predefined screen area. The cycle time is very long to make the movement of the projected image imperceptible. The use of the orbiting kit is described in appendix A.

Order number : R9827780

Soft edge matching kit

Multi-screens are popular for many applications. In these installations, the goal is to obtain a contiguous matched image, forming one homogenous view. The soft edge matching feature provides a solution to the annoying side effects when adjusting two or more projected images next to each other. To improve this junction, both images must be overlapping within a certain percentage of the total screen width. During the overlapping period, both video signals are modulated by appropriate waveforms so that the resulting light output equals the rest of the image.

Contrast modulation kit

The contrast modulation kit is designed to improve overall light output uniformity and to overcome the inherent color shift errors, normally associated with CRT projection. The laws of physics applied to projection optics dictate that the center of the projected image will be brighter than the corners, this phenomenon is normally referred to as 'corner fall off'. Due to the normal off-axis projection of the red and blue images, CRT projection displays a phenomenon referred to as 'color shift', whereby one side of the image is reddish and the other blueish. By modulating the amplitude of the video signal with appropriate waveforms we are able to overcome both problems.

The use of this contrast modulation kit is described in appendix C.

Order number : R9827800

APPENDIX A : BATTERY REPLACEMENT IN THE RCU

Battery replacement in the RCU.

Remove the battery cover on the backside of the remote control by pushing the indicated handle a little to the bottom of the RCU. Lift up the top side of the cover at the same time (fig. 1).

Remove the battery from the compartment and disconnect the contact plate (fig. 2).

Connect a new 9 V battery (type E-block, e.g. 6F22S or equivalent) to the contact plate.

Insert the battery back into the compartment and put the cover back.

Attention : when a new battery is installed, the projector address must be reprogrammed before using the RCU.

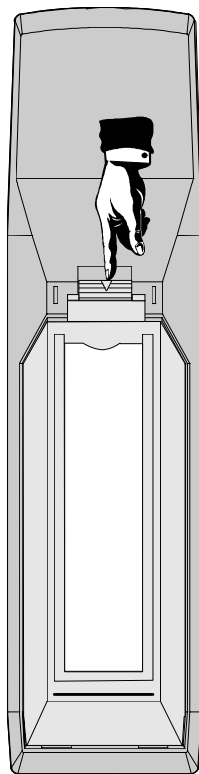

fig.1

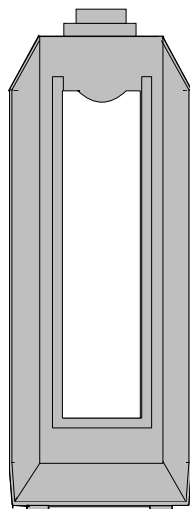
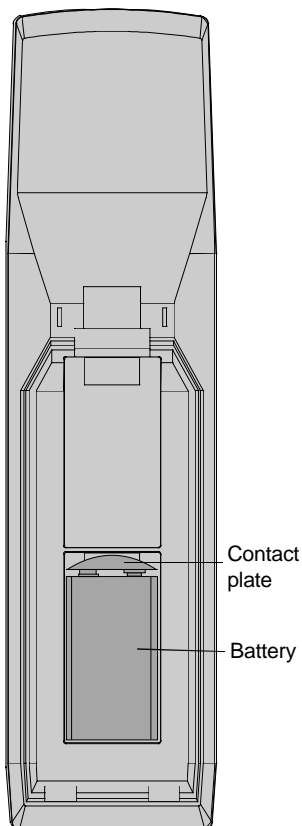

fig.2

310a.DRW

APPENDIX B : ORBITING

Orbiting (option)

Static pictures are very often shown on large screen projectors, especially in process control and presentation applications. Due to the fact that the same picture information is shown for a long period on the same place, picture tubes can be damaged by 'local burn-in'. To avoid this problem, BARCO has designed special Orbiting circuitry which moves the picture very slowly around a predefined screen area. The orbiting circuitry has been designed using a very long cycle time to make the movement of the projected image imperceptible.

Adjustment procedure :

The orbiting path is automatically added to the Random Access Adjustment mode menu when installed.

Press **ADJUST** to enter the Adjustment mode and select Random.

The Random Access Adjustment Mode menu will be displayed. Highlight *ORBITING* with the control disk and press **ENTER**.

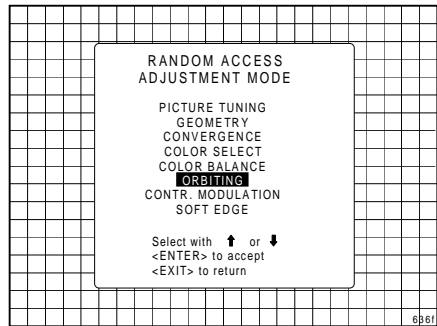

ENTER continues to the Master Orbiting menu.

EXIT returns to the Operational mode.

ADJUST returns to the Operational mode.

Orbiting mode toggle switches

The orbiting module is provided with a three pin connector for connection with the BARCO's BCI link option module, used in multiple projector installations. For Orbiting, one projector operates as master whereas the others operate as slave.

Master/slave toggle

Highlight '*CHANGE TO SLAVE*' with the control disk and press **ENTER** to set the projector as Slave.

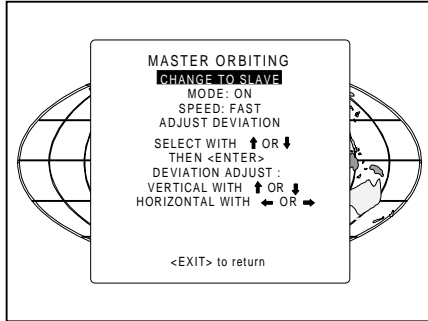

Highlight '*CHANGE TO MASTER*' with the control disk and press **ENTER** to set the projector as Master.

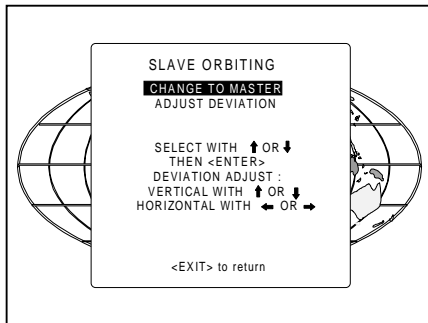

Orbiting ON/OFF toggle (only in Master Orbiting)

Highlight '*MODE : ON*' with the control disk and press **ENTER** to set the ORBITING OFF.
 Highlight '*MODE : OFF*' with the control disk and press **ENTER** to set the ORBITING ON.

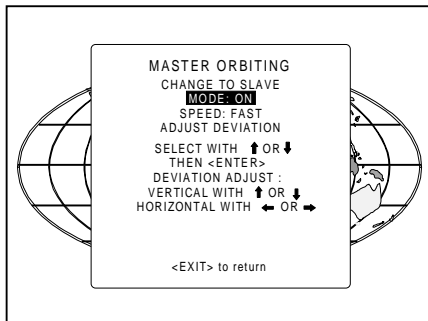

ENTER toggles between mode on and off.
EXIT returns to the Path Selection menu.

APPENDIX B : ORBITING

Orbiting speed toggle (only in MASTER Orbiting)

Highlight '*SPEED : SLOW*' with the control disk and press **ENTER** to set the ORBITING SPEED to Fast.

Highlight '*SPEED : FAST*' with the control disk and press **ENTER** to set the ORBITING SPEED to Slow

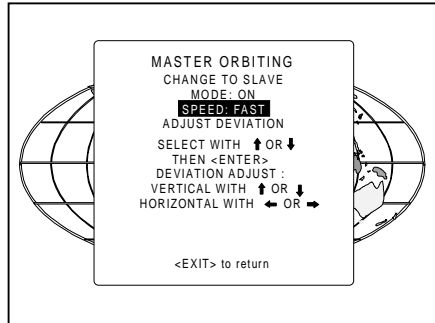

ENTER continues to Set up Orbiting.
EXIT returns to the Path Selection menu.
ADJUST returns to the Operational mode.

Orbiting alignment

Preparation :

Before proceeding to the alignment of the Orbiting default settings, be sure that the Horizontal Phase and the Raster shift are correctly aligned with the Orbiting mode set to OFF.

This alignment must be performed in case of a multiple projector installation with Master and Slave projectors in order to ensure a correct operation of the Orbiting for all projectors.

Adjustment procedure stand alone projector :

Highlight '*ADJUST DEVIATION*' with the control disk and press **ENTER**.

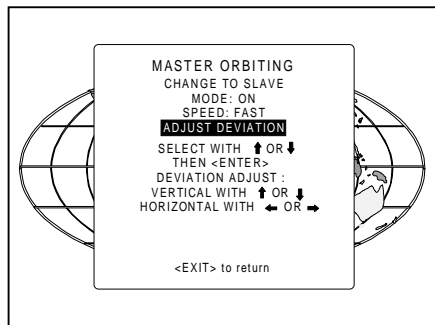

When adjusting the horizontal and the vertical deviation, the picture moves in the corresponding direction, allowing the set up of the deviation without orbiting operation.

Push the control disk to the left (right) or up (down) to toggle between Hor. and Vert. deviation adjustment.

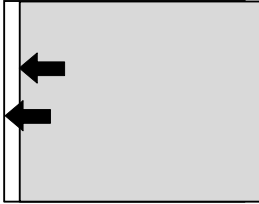

Adjust horizontal deviation by pushing the control disk to the left or to the right

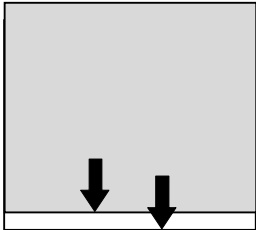

Adjust vertical deviation by pushing the control disk up or down

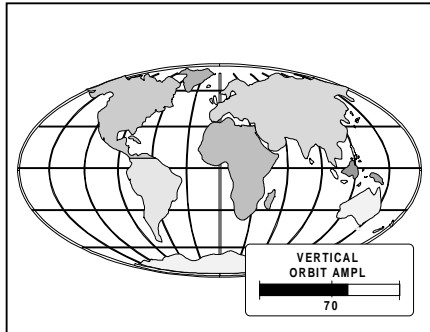
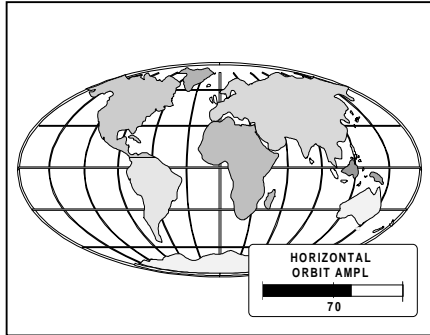

ENTER will select the Orbiting adjustment menu.
EXIT returns to the Path Selection menu.

APPENDIX B : ORBITING

Adjustment procedure multiple projector installations :

Important : to allow corrections in the deviation alignments of the slave projectors, never adjust the deviations of the master projector to its maximum.

Default setting of the Master projector see 'Stand alone projector'.

Highlight '*ADJUST DEVIATION*' with the control disk and press **ENTER**.

When adjusting the horizontal and the vertical deviation, the picture moves in the corresponding direction, allowing the set up of the deviation without orbiting operation.

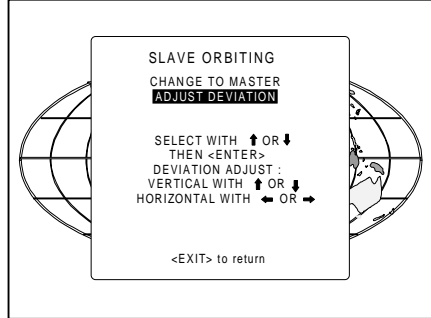

Push the control disk to the left (right) or up (down) to toggle between Hor. and Vert. deviation adjustment.

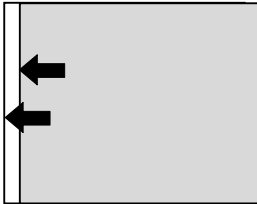

Adjust horizontal deviation by pushing the control disk to the left or to the right

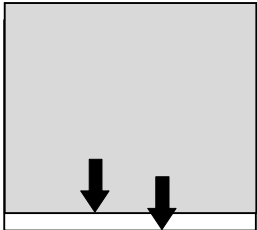

Adjust vertical deviation by pushing the control disk up or down

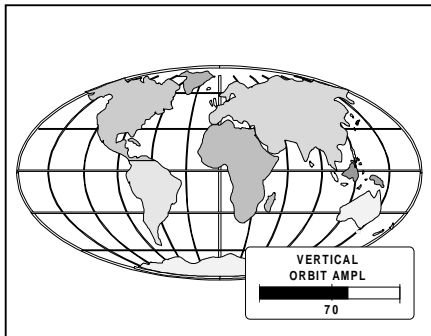
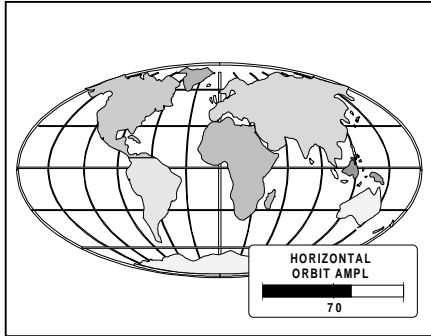

ENTER will select the Orbiting Adjustment menu.

EXIT returns to the Path Selection menu.

APPENDIX C : SOFT EDGE MATCHING

Soft edge matching (option)

Multi-screens are popular for many applications. In these installations, the goal is to obtain a contiguous matched image, forming one homogenous view. The soft edge matching feature provides a solution to the annoying side effects when adjusting two or more projected images next to each other. To improve this junction, both images must be overlapping within a certain percentage of the total screen width. During the overlapping period, both video signals are modulated by appropriate waveforms so that the resulting light output equals the rest of the image.

Picture with hard edging

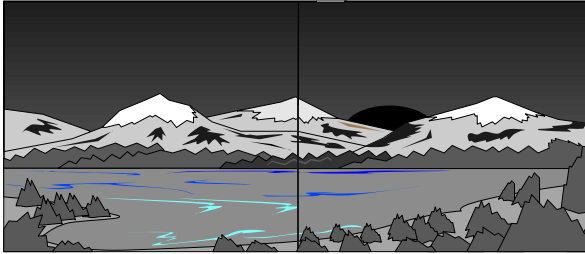

Picture with overlapping

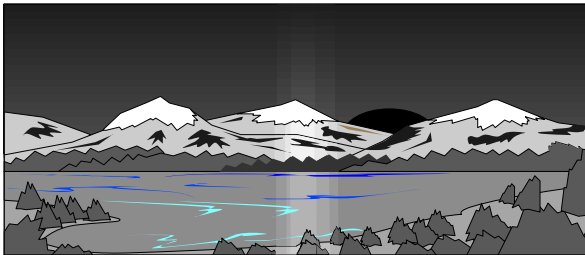

Picture with soft edging

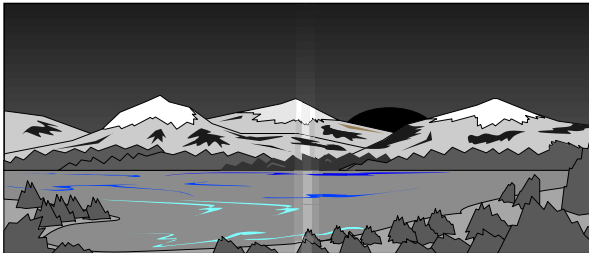

Basic concept

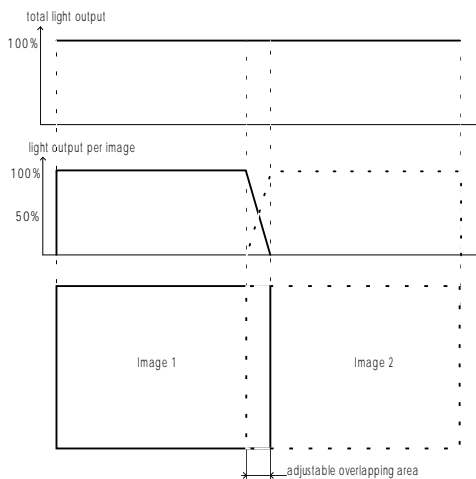

Adjustment procedure :

Start up the adjustment mode by pressing **ADJUST** (see also chapter 'Start up of the adjustment mode')

Highlight *Random access* with the control disk and press **ENTER** to start up the Random Access Adjustment mode (see also chapter Random Access Adjustment mode). The *Random Access Adjustment Mode main menu* will be displayed.

When the *Soft edge matching option* is installed, the projector automatically detects this option and displays the selection (activation) line in the Random Access Adjustment Mode main menu.

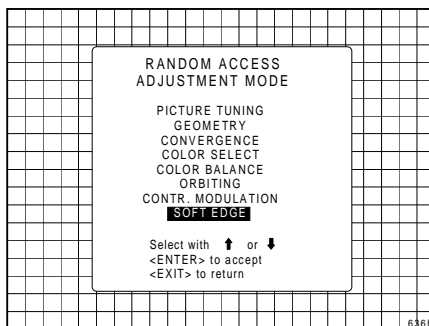

Highlight **SOFT EDGE** with the control disk and press **ENTER** to select.

The Soft Edge Correction menu offers the possibility to display a horizontal test pattern and a vertical test pattern. When the test patterns are ON, the 'real' soft edge is disabled, marking lines for the start and stop position of soft edging and the overlapping area are displayed. When the test patterns are OFF, the 'real' soft edge is enabled again.

Note : blanking corrections must be set to display a normal video image.

ENTER displays the Soft Edge Matching menu.
EXIT returns to the Path Selection menu.
ADJUST returns to the Operational mode.

APPENDIX C : SOFT EDGE MATCHING

Each overlap area (left and right) is determined by a start (stop) position and an area width.

The start (stop) position for the top (bottom) overlap area is determined by the blanking adjustment.

Highlight *H TEST MODE* and press **ENTER**.

The test image is enabled to adjust the start (stop) position and the area width.

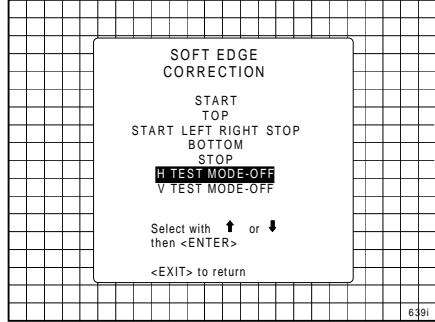

ENTER toggles between H test mode OFF and ON.

EXIT returns to the Random Access Adjustment Mode main menu.

ADJUST returns to the Operational mode.

The test image is projected on the normal image

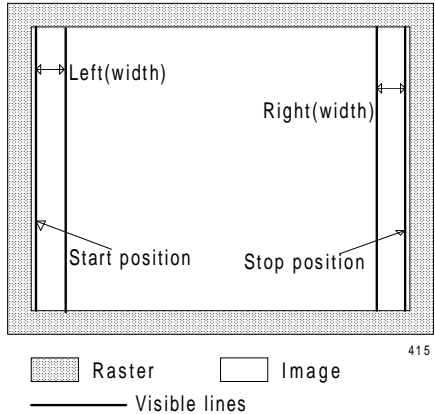

Start position

Highlight *START POSITION* with the control disk and press **ENTER**.

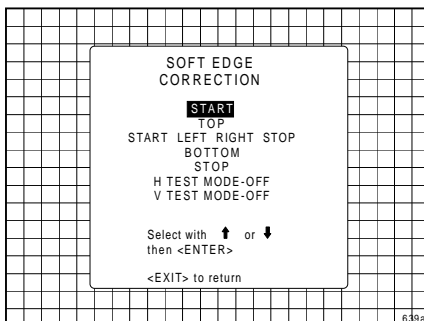

ENTER displays the normal image superimposed with the internal generated test signal.
EXIT returns to the Random Access Adjustment Mode main menu.
ADJUST returns to the Operational mode.

Adjust the first left line of the generated test image to determine the image border. This image border is the start position of the soft edge area.

Note : when the start position is not visible by the first image display, adjust with the control disk until the line becomes visible. Adjust then until the start position is correct.

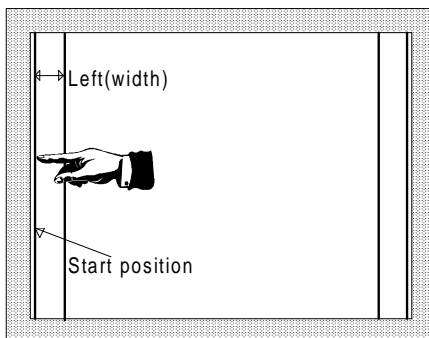

ENTER displays the Soft Edge menu.

APPENDIX C : SOFT EDGE MATCHING

Left image area

Highlight **LEFT** with the control disk and press **ENTER**.
The normal image superimposed with the test pattern will be displayed.

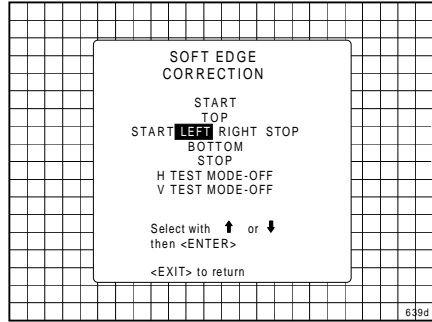

ENTER displays the normal image superimposed with the internal generated test signal.

EXIT returns to the Random Access Adjustment Mode main menu.

ADJUST returns to the Operational mode.

Adjust the left soft edge area width by moving with the control disk the second test pattern line towards its desired position.

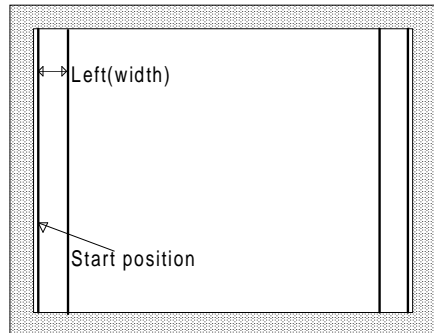

ENTER returns to the Soft Edge Correction menu.

Stop position

Highlight *STOP POSITION* with the control disk and press **ENTER**.

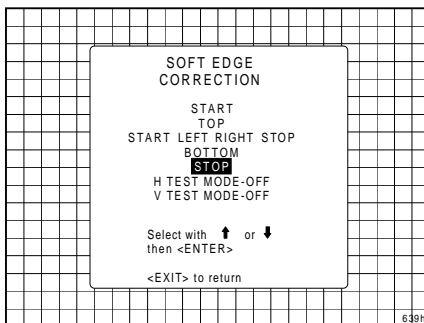

ENTER displays the normal image superimposed with the internal generated test signal.

EXIT returns to the Random Access Adjustment Mode main menu.

ADJUST returns to the Operational mode.

Adjust the last right line of the generated test image to determine the image border. This image border is the end position of the right soft edge area.

Note : when the stop position is not visible by the first image display, push the control disk until the line becomes visible. Adjust then until the stop position is correct.

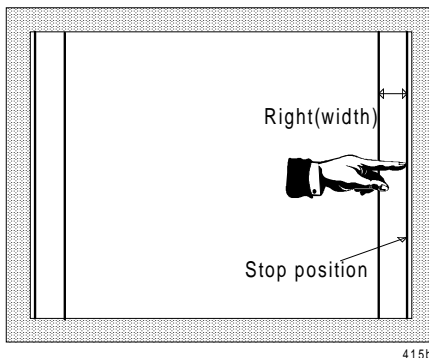

ENTER displays the Soft Edge menu.

APPENDIX C : SOFT EDGE MATCHING

Right image area

Highlight **LEFT** with the control disk and press **ENTER**.

The normal image, superimposed with the test pattern will be displayed.

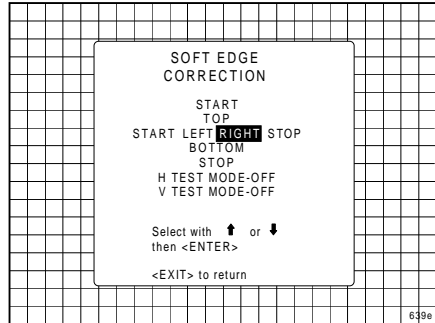

ENTER displays the normal image superimposed with the internal generated test signal.

EXIT returns to the Random Access Adjustment Mode main menu.

ADJUST returns to the Operational mode.

Use the control disk to adjust the right soft edge area width by moving the second test pattern line towards its desired position.

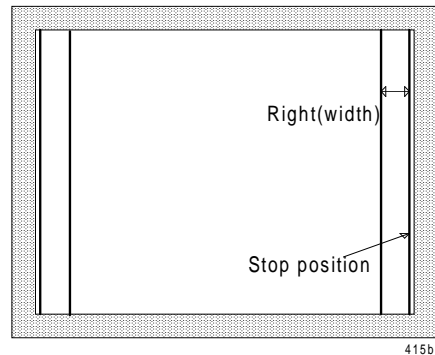

ENTER returns to the Soft Edge Correction menu.

Vertical test mode

Highlight 'V TEST MODE' and press **ENTER**.

The test image is enabled to adjust the start (stop) position and the area width.

When switching the V test mode to On, the H test mode will switch to OFF.

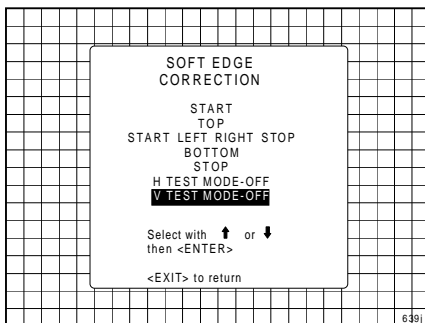

ENTER toggles between V test mode OFF and ON.
EXIT returns to the Random Access Adjustment Mode main menu.
ADJUST returns to the Operational mode.

The test image is projected on the normal image. The start (stop) position is determined by the blanking controls. The blanking adjustment is also the image border for the begin (end) position of the soft edge area. Adjust the blanking for a normal video image.

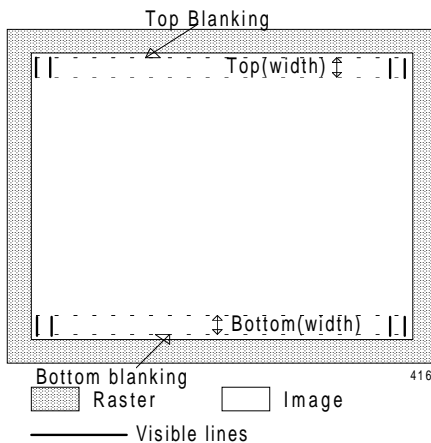

APPENDIX C : SOFT EDGE MATCHING

Top soft edge area adjustment

Highlight *TOP* with the control disk and press **ENTER**.

The normal image, superimposed with the test pattern will be displayed.

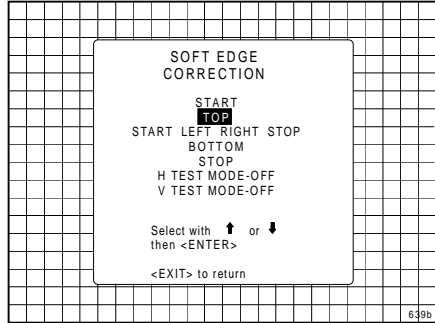

ENTER displays the normal image superimposed with the internal generated test signal.

EXIT returns to the Random Access Adjustment Mode main menu.

ADJUST returns to the Operational mode.

Adjust the top soft edge area width by changing the length of the internal generated lines with the control disk.

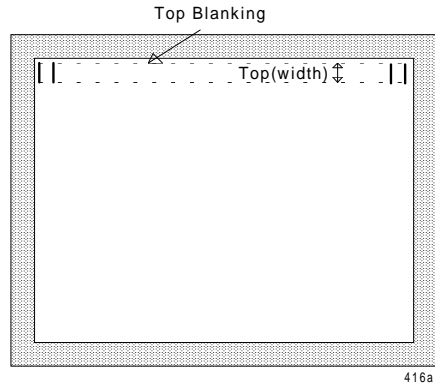

ENTER returns to the Soft Edge Correction menu.

Bottom soft edge area adjustment

Highlight *BOTTOM* with the control disk and press **ENTER**.

The normal image, superimposed with the test pattern will be displayed.

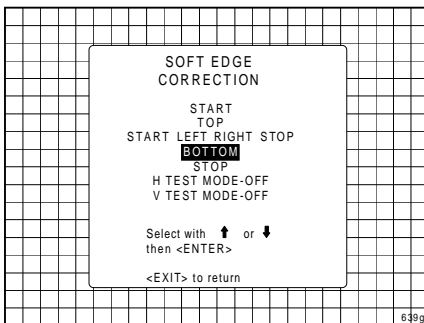

ENTER displays the normal image superimposed with the internal generated test signal.
EXIT returns to the Random Access Adjustment Mode main menu.
ADJUST returns to the Operational mode.

Adjust the bottom soft edge area width by changing the length of the internal generated lines with the control disk.

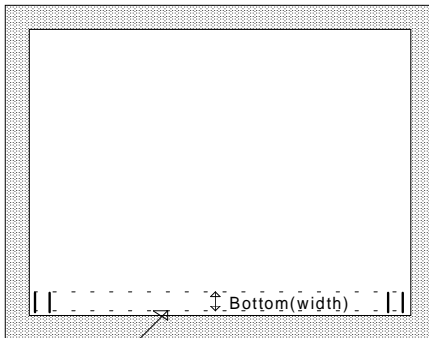

Bottom blanking

ENTER returns to the Soft Edge Correction menu.

APPENDIX D : CONTRAST MODULATION

Contrast modulation (option)

Today multi-screens are very popular for many applications e.g. simulation business. In these installations, the goal is to obtain a continuous matched image, forming one homogeneous view. The viewer wants to see an overall light output uniformity.

The laws of physics applied to projection optics dictate that the center of the projected image will be brighter than the corners; this phenomenon is normally referred to as 'corner fall off'. Secondly, due to the normal off-axis projection of the red and blue images, CRT projection displays a phenomenon referred to as 'color shift', whereby one side of the screen is reddish and the other blueish.

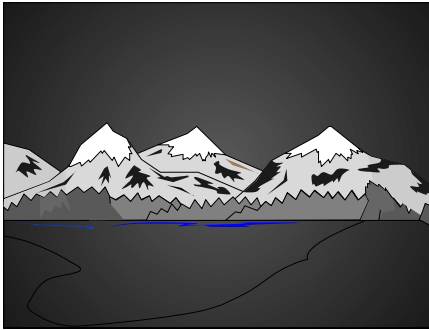

Picture without
contrast modulation

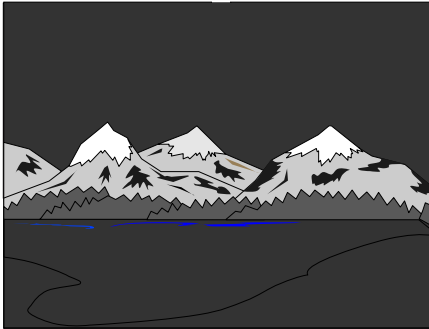

Picture with
contrast modulation

APPENDIX D : CONTRAST MODULATION

Basic concept

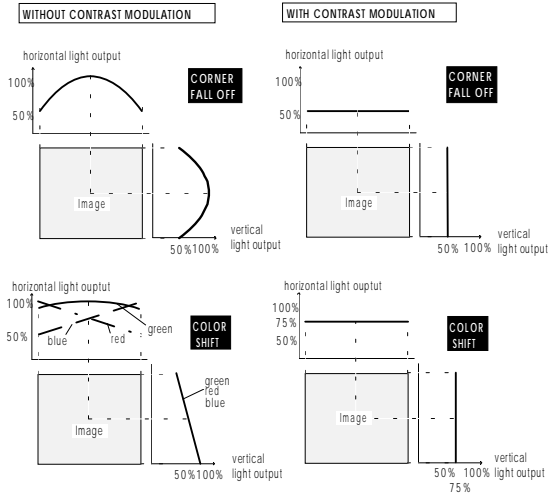

Adjustment procedure :

Start up the adjustment mode by pressing **ADJUST** (see also chapter 'Start up of the adjustment mode')

Highlight *Random Access* with the control disk and press **ENTER** to start up the Random Access Adjustment mode (see also chapter Random Access Adjustment mode). The *Random Access Adjustment Mode main menu* will be displayed.

When the *Contrast Modulation option* is installed, the projector automatically detects this option and displays the selection (activation) line in the Random Access Adjustment Mode main menu.

Highlight **CONTR. MODULATION** with the control disk and press **ENTER** to select.

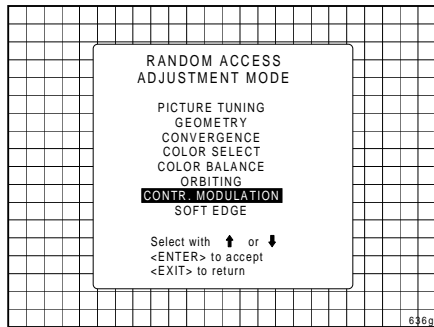

Note : An external generated white image will be useful during the adjustment.

Note : be sure the horizontal phase is correctly adjusted. The image must be centered on the raster with the horizontal phase adjustment, otherwise it is not possible to adjust the contrast modulation correctly.

ENTER selects the Contrast Modulation menu.
EXIT returns to the Path Selection menu.
ADJUST returns to the Operational mode.

APPENDIX D : CONTRAST MODULATION

The first 3 adjustments (horizontal red, green and blue) are used for horizontal light equalisation for the three specific colors separately. This compensates the error due to the different horizontal position of the picture tubes. One side of the image is reddish and the other side is blueish. This phenomenon is called *Color shift*.

The *VERTICAL* adjustment affects the three colors at the same time and corrects the vertical error in light output due to the projection angle (10.5 degrees).

Left-right (horizontally) and top-bottom (vertically) adjustments improve the '*hot spot*' in the center of the screen.

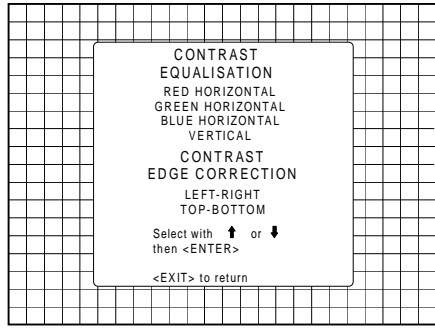

Contrast equalisation ('Color Shift')

Highlight *RED HORIZONTAL* with the control disk and press **ENTER**. Only a red image is displayed. Use the control disk to equalise the light output on the left and right side of the image. The best result is obtained on a white image by looking on the left and the right side until both or equal, or by using a very sensitive light meter.

ENTER returns to the Contrast Modulation menu.

Repeat this adjustment for green and blue by selecting first Green horizontal and then Blue horizontal.

Remark : When the end of adjustment range is reached for red and blue, the green image will be displayed too, to give you the message 'end of adjustment range'. The green image remains active until a new selection is made.

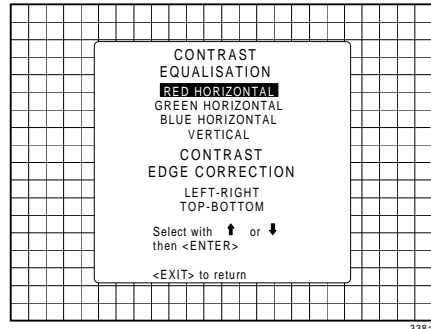

ENTER displays the red image.
EXIT returns to the Random Access Adjustment Mode main menu
ADJUST returns to the Operational mode.

Highlight **VERTICAL** with the control disk and press **ENTER**. This adjustment is done for all three colors at the same time.

Use the control disk to equalise the vertical light output and press **ENTER** to continue.

The best result is obtained on a white image by looking on the top and the bottom side until both are equal, or by using a very sensitive light meter.

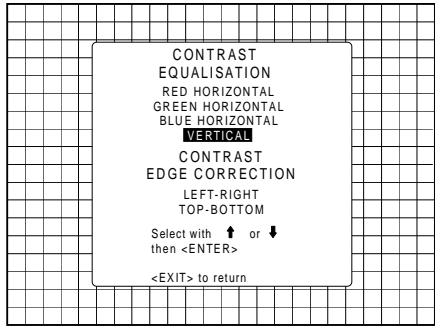

338d

ENTER selects the Vertical Contrast Equalisation option.

EXIT returns to the Random Access Adjustment Mode main menu.

ADJUST returns to the Operational mode.

Contrast edge correction ('hot spot')

Highlight **LEFT-RIGHT** with the control disk and press **ENTER** to start the horizontal 'hot spot' correction in the center of the screen. Adjust with the control disk for the same light output in the corners as in the center of the image.

This left-right adjustment must be done in combination with the top-bottom adjustment as both adjustments influence each other.

Note : these adjustments will reduce the total light output, so do not over adjust.

Hint : A bar scale of 10 - 15 for both adjustments gives a good result.

Press **ENTER** to return to the Contrast Modulation menu.

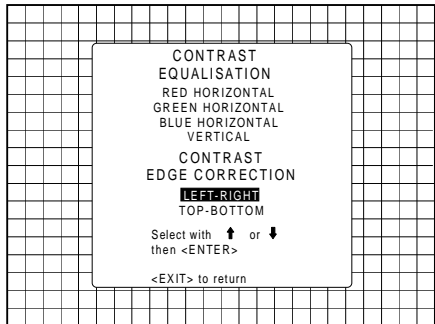

338a

ENTER starts the Left-Right Contrast Edge Correction.

EXIT returns to the Random Access Adjustment main menu.

ADJUST returns to the Operational mode.

APPENDIX D : CONTRAST MODULATION

Highlight *TOP-BOTTOM* with the control disk and press **ENTER** to start the vertical '*hot spot*' correction in the center of the screen. Adjust with the control disk for the same light output in the corners as in the center of the image.

This top-bottom adjustment must be done in combination with the left-right adjustments as both adjustments influence each other.

Note : these adjustments will reduce the total light output, so do not over adjust.

Hint : A bar scale of 10 - 15 for both adjustments gives a good result.

Press **ENTER** to return to the Contrast Modulation menu.

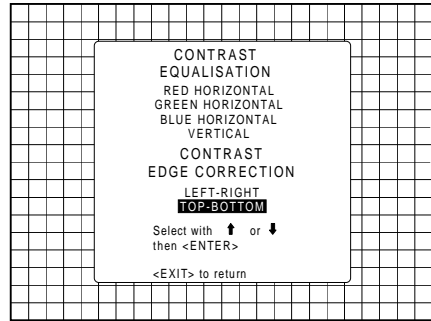

3387

ENTER starts the Top-Bottom Contrast Edge Correction.

EXIT returns to the Random Access Adjustment Mode main menu.

ADJUST returns to the Operational mode.



Adjustment Blocks (memory blocks)

As the BARCOVISION 701 MULTIMEDIA is digitally controlled, all geometry and convergence adjustments are stored in the projector's memory as numeric values. These numeric values are used to control digital potentiometers which in turn, control the projector. Each source connected to the projector has a unique set of adjustment data which is automatically downloaded into the projector's digital potentiometers as the source is selected. This set of adjustment data is referred to as an "adjustment block".

An adjustment table is automatically created for a source when the source is first connected to the projector and the adjust mode is entered. If other sources have already been connected to the projector and geometry and convergence adjustments have been performed on these sources, the projector will use Linear Digital Interpolation to create a new block for the new source. This block will provide an initial set of adjustments for the new source that have been calculated by the projector from "previous experience".

The projector's memory has the capacity to store 32 adjustment blocks. The adjustment block consists of two parts, the block header and the data representing the convergence and geometry adjustments of the source the block corresponds to. The block header contains the basic characteristics of the source and the projector configuration used to display the source.

<i>Block Header</i>	<i>example of block header</i>
Block number	01
Source number	01
Horizontal frequency	15.6 kHz
Vertical frequency	50 Hz
Input type	video
Scan inversion switch configuration	front/ceiling

The data representing the geometry and convergence adjustments for the source follows the block header.

The 32 adjustment blocks are in use. What to do?

A. Projector without any peripheral connected to the 'peripheral 800 port'

Connect a new source to the projector. Due to the fact that there are no adjustment

blocks available, the projector displays a warning.

Press **ENTER** to continue and start up the adjustment mode to delete a block.

It will be necessary to delete an existing block to create adjustment space for the new source.

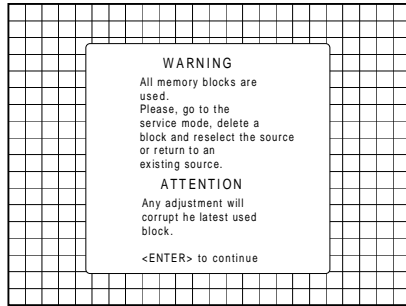

When **ENTER** is pressed, the warning disappears. Press **ADJUST** to start up the 'adjustment mode' and select 'Service' with the arrow keys. Follow the procedure as described in 'Deletion of blocks'.

Reselect the new source with the numeric keys on the RCU or the local keypad even when the new source is already displayed on the screen.

By reselecting this new source, you force the projector to write the source header in the free space created by the previous deletion action. The new source can now be adjusted, the settings will be stored for future use.

Attention :

When the warning is displayed by pressing **ENTER**, you will see the normal image. Do not forget to start the 'deletion of a block' procedure, otherwise the image settings of the last selected source will be overwritten with the new adjustments.

B. projector equipped with RCVDS or VS05.

When a new source is connected :

- a) the projector looks for the most corresponding adjustment block. If such a block is present, the settings will be used to display the connected source.
- b) the projector does not find a matching block. The warning is displayed. Follow the procedure as in A.

APPENDIX F : SOURCE NUMBERS 90 - 99

Source numbers 90 - 99

Source numbers 90 - 99 do not correspond to physical inputs to the projector or RCVDS05. They are used to assign an additional adjustment block to a source. This additional adjustment block may contain different geometry and convergence settings, sync fast/slow positions and enhanced blue on/off settings. The relationship between source numbers 0 - 9 and 90 - 99 (projector with RCVDS) or 1 - 5 and 91 - 95 (stand-alone projector) is shown in the diagram below.

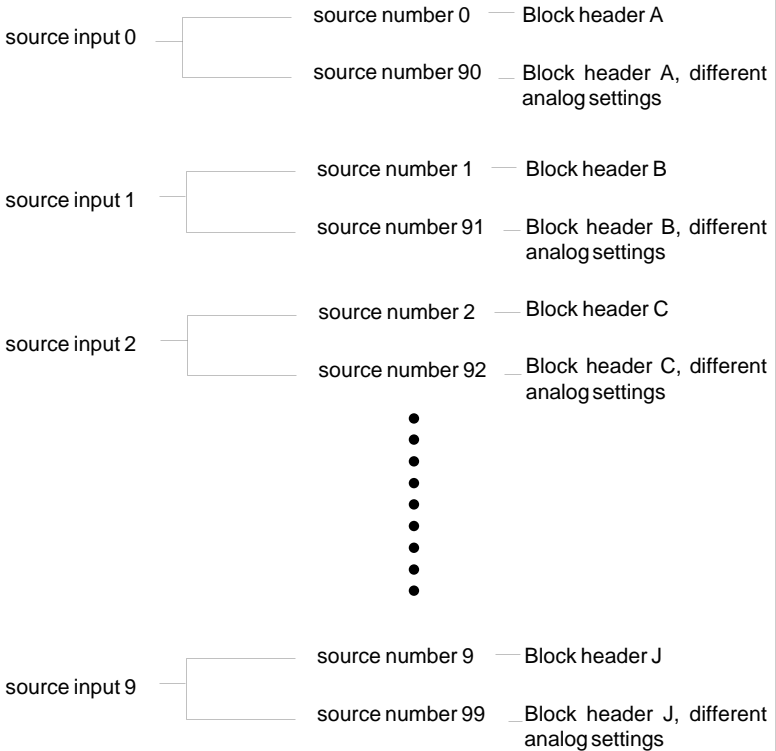

The alternate adjustment block for sources 0 - 9 (projector with RCVDS) or 1 - 5 (stand-alone projector) is activated by selecting the corresponding source number 0 - 9 (projector with RCVDS) or 1 - 5 (stand-alone projector). Once this source number is selected, the alternate block of adjustment data is in use and may be modified via the adjust mode of the projector. The alternate adjustment block is automatically stored.

Follow the steps below to create a second adjustment block for a source between 0 and 9.

1. Select the source between 0 and 9 that the second adjustment block is to be created for.
2. Select the corresponding source number between 90 and 99. The adjustment block for the source number between 0 and 9 is copied to the corresponding source number between 90 and 99.
3. Enter the adjust mode and make any desired changes (geometry, convergence, sync fast/slow, enhanced blue on/off) to the second adjustment block.
4. Exit the adjust mode.

Note : the above also applies to source number 1 - 5 and 91 - 95 of a stand alone projector (no RCVDS).

RCU	
INPUT SOURCES	
PROJECTOR	
1	
2	
3	
4	
5	
6	
7	

RCU	
INPUT SOURCES	
PROJECTOR	
1	
2	
3	
4	
5	
6	
7	

INPUT SOURCES	
RCVDS	
1	
2	
3	
5	
6	
7	
8	
9	
10	

INPUT SOURCES	
RCVDS	
1	
2	
3	
5	
6	
7	
8	
9	
10	