

# BARCO

BARCO PROJECTION SYSTEMS

**BARCO**

**GRAPHICS**  
**6300**

**R9001440**

**OWNER'S MANUAL**

Date :  
21112000

Rev. :  
06

Art. No. :  
R5975879

## Federal communication commission (FCC statement)

This equipment has been tested and found to comply with the limits for a class B digital device, pursuant to Part 15 of the FCC Rules. These limits are designed to provide reasonable protection against harmful interference when the equipment is operated in a commercial environment. This equipment generates, uses, and can radiate radio frequency energy and, if not installed and used in accordance with the instruction manual, may cause harmful interference to radio communications. Operation of this equipment in a residential area is likely to cause harmful interference in which case the user will be required to correct the interference at his own expense.

Instructions to the user :

if this equipment does cause interference to radio or television reception, the user may try to correct the interference by one or more of the following measures :

- Re-orientation of the receiving antenna for the radio or television.
- Relocate the equipment with respect to the receiver.
- Plug the equipment into a different outlet so that the equipment and receiver are on different branch circuits.
- Fasten cables connectors to the equipment by mounting screws.

Note :

*The use of shielded cables is required to comply within the limits of Part15 of FCC rules and EN55022.*

Due to constant research, the information in this manual is subject to change without notice.

Produced by BARCO NV, December 1998.  
All rights reserved.

Trademarks are the rights of their respective owners.

### **BARCO n.v./Projection Systems**

Noordlaan 5

B-8520 Kuurne

Belgium

Tel : +32/56/368211

Fax : +32/56/351651

E-mail : [sales.bps@barco.com](mailto:sales.bps@barco.com)

Visite Barco at the web : <http://www.barco.com>

Printed in Belgium

## Table of Contents

<b>UNPACKING AND DIMENSIONS</b> .....	<b>1-1</b>	Color Temperature .....	9-7
Unpacking .....	1-1	Gamma .....	9-7
Projector dimensions .....	1-1	Decoding EBU/IRE .....	9-7
Battery installation in the RCU .....	1-2	Input Balance .....	9-8
<b>INSTALLATION GUIDELINES</b> .....	<b>2-1</b>	Dynamic Color Depth .....	9-8
Environment .....	2-1	Noise Reduction .....	9-8
Environmental condition check .....	2-1	Audio Tuning .....	9-9
What about ambient light ? .....	2-2	Volume, Balance, Bass and Treble .....	9-9
Which screen type? .....	2-2	Mute .....	9-9
What image size? How big should the image be? .....	2-2	Fade .....	9-9
Where to install the projector? .....	2-3	Mode [stereo]/[mono] .....	9-10
How to install a projection lens? .....	2-4	Video - Audio lock .....	9-10
<b>LOCATION AND FUNCTIONS OF CONTROL</b> .....	<b>3-1</b>	Geometry .....	9-10
Front Panel Terminology .....	3-1	Shift .....	9-11
Source & Power Connections .....	3-1	Side Keystone .....	9-11
Communication Connections .....	3-2	Blanking .....	9-12
Control Panel Terminology .....	3-2	Aspect Ratio [4:3]/[16:9] .....	9-13
a. Local keypad .....	3-2	Options .....	9-13
b. Remote control .....	3-3	<b>INSTALLATION MODE</b> .....	<b>10-1</b>
<b>INSTALLATION SET UP</b> .....	<b>4-1</b>	Starting up the Installation Mode .....	10-1
Configuration .....	4-1	Input Slots .....	10-1
<b>CONNECTIONS</b> .....	<b>5-1</b>	No Signal .....	10-2
Power connection .....	5-1	Lens Adjustments .....	10-2
AC Power (mains) cord connection .....	5-1	Zoom/Focus/Shift .....	10-2
Fuses .....	5-1	Text Box Position .....	10-3
Switching on .....	5-1	Quick Access Keys .....	10-3
Lamp Run Time .....	5-2	Start Up Mode .....	10-3
Lamp Run Time Warning .....	5-2	800 Peripheral .....	10-4
Switching to Stand-by .....	5-2	Output module selection .....	10-4
Switching Off .....	5-2	Infrared Communication .....	10-4
Input Connections .....	5-2	Configuration .....	10-4
5-cable Input Slot (slot 1) .....	5-3	OSD color (On-Screen Display) .....	10-4
Computer input/Monitor output .....	5-4	Internal Patterns .....	10-5
Video Input .....	5-4	Switching Mode .....	10-5
S-Video Input .....	5-5	<b>SERVICE MODE</b> .....	<b>11-1</b>
Serial Digital Input / Serial Digital Output .....	5-5	Starting up the Service Mode .....	11-1
IEEE 1394 Input .....	5-6	Identification .....	11-2
Communication Connections .....	5-6	Change Password .....	11-3
RS232 in / RS232 out .....	5-6	How to enable or disable the password function ? .....	11-3
Communication port for communication with peripherals .....	5-7	How to change the password ? .....	11-3
Audio Connections .....	5-7	Change Language .....	11-3
<b>CONTROLLING</b> .....	<b>6-1</b>	Change Projector Address .....	11-3
How to use the RCU? .....	6-1	Projector Address .....	11-3
Projector address .....	6-2	Common Address .....	11-4
Common Address .....	6-2	Change Baudrate PC .....	11-4
Displaying a Projector Address .....	6-2	Reset Lamp Runtime .....	11-4
How to Program an Address into the RCU? .....	6-2	Lamp Run Time History .....	11-4
Picture controls with direct access .....	6-2	Dimming .....	11-5
Sound controls with direct access .....	6-3	BARCO logo .....	11-5
The Pause key .....	6-3	Panel Adjustments .....	11-5
The Selection key .....	6-4	Uniformity .....	11-6
<b>START UP OF THE ADJUSTMENT MODE</b> .....	<b>7-1</b>	Preset Input Balance .....	11-6
Adjustment Mode .....	7-1	I2C diagnosis .....	11-6
<b>AUTO IMAGE ADJUSTMENT</b> .....	<b>8-1</b>	<b>STANDARD SOURCE SET UP FILES</b> .....	<b>A-1</b>
Auto Image Adjustment .....	8-1	<b>LENSES</b> .....	<b>B-1</b>
Adjust .....	8-1	Lens Cleaning Procedure .....	B-1
<b>RANDOM ACCESS ADJUSTMENT MODE</b> .....	<b>9-1</b>	Lenses .....	B-2
Starting up the Random Access Adjustment Mode .....	9-1	<b>SOURCE NUMBERS 81 - 86 AND 91 - 96</b> .....	<b>C-1</b>
File Service .....	9-2	Projector without any 800 peripheral connected .....	C-1
Load File .....	9-2	Projector with a 800 peripheral connected .....	C-1
Edit File .....	9-3	Source numbers 91 - 99 .....	C-1
Delete .....	9-5	Source numbers 81 - 86 .....	C-2
Rename .....	9-5		
Copy .....	9-5		
File Options .....	9-6		
Picture Tuning .....	9-6		
CTI ON/OFF .....	9-6		

# 1

## UNPACKING AND DIMENSIONS

### Unpacking

To open the banding, pull on the clip as shown in the first drawing.

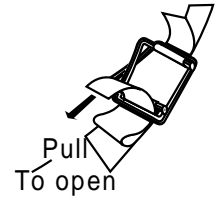

Take the projector out of its shipping carton and place it on a table.

Save the original shipping carton and packing material, they will be necessary if you ever have to ship your projector. For maximum protection, repack your projector as it was originally packed at the factory.

Contents of the complete unit (box) :

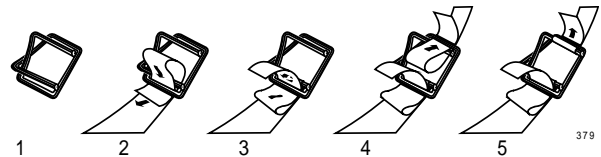

- 1 BARCOGRAPHICS 6300 (weight  $\pm$  17 kg)
- 1 remote control unit RCU + 2 batteries.
- 1 power cable with outlet plug type CEE7.
- 1 owner's manual
- 1 safety manual

### Projector dimensions

(units : mm)  
25.4 mm = 1"

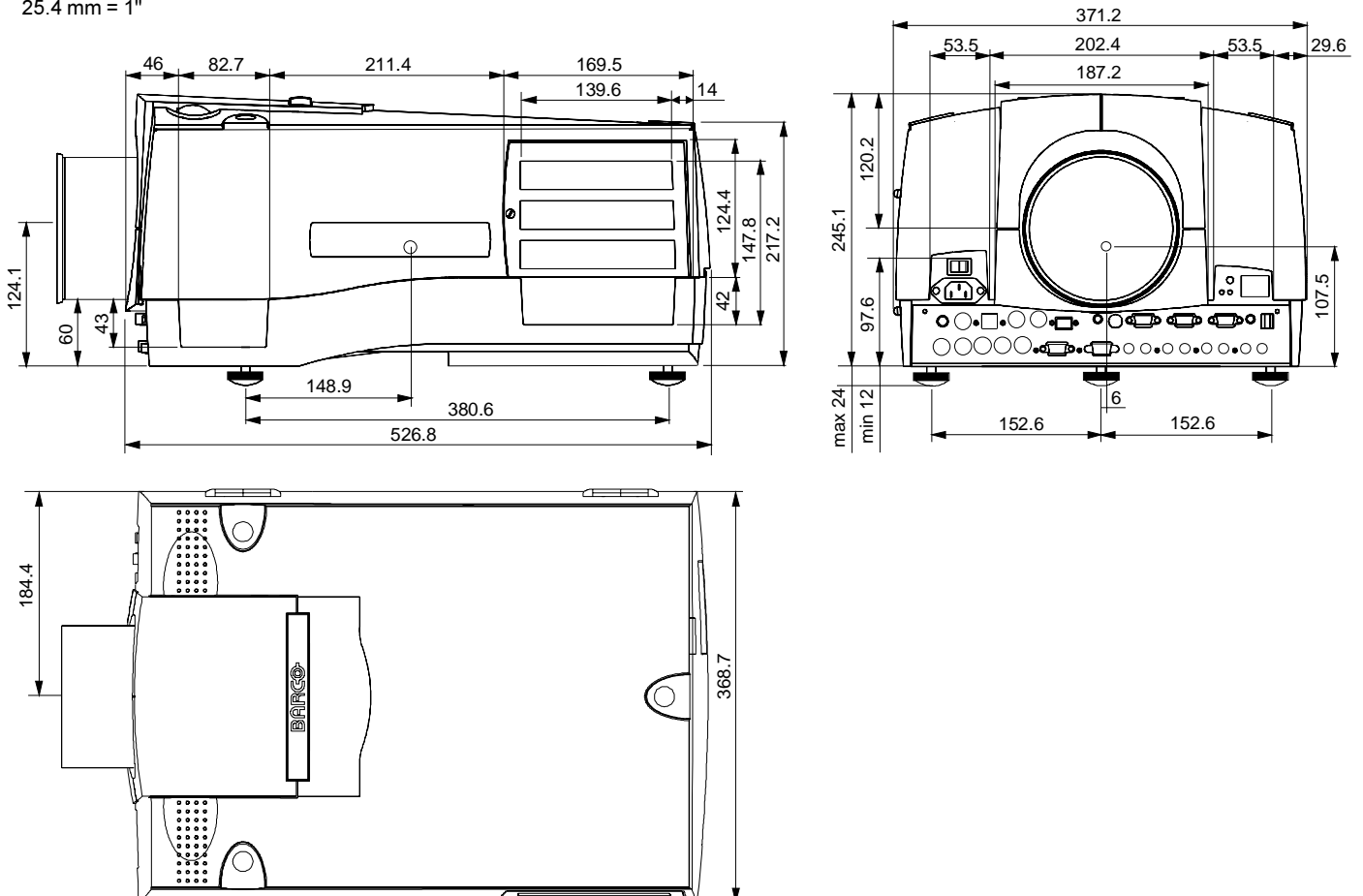

### Battery installation in the RCU.

Two batteries are packed together with the RCU. Before using your RCU, install first these batteries.

- 1 Remove the battery cover on the backside by pushing the handle a little towards the bottom of the RCU.
- 2 Lift up the top side of the cover at the same time.
- 3 Insert the batteries as indicated in the RCU.
- 4 Put the battery cover on its place.

How to replace the batteries in the RCU ?

To replace the batteries :

- 1 Remove the battery cover on the backside by pushing the handle a little towards the bottom of the RCU.
- 2 Lift up the top side of the cover at the same time.
- 3 Push on the + side of the battery towards the - side
- 4 Lift up the battery at the same time.
- 5 Repeat for the second battery.
- 6 Insert the batteries as indicated in the RCU (battery type AA or LR6 or equivalent).
- 7 Put the battery cover on its place.

*Note, only important if more than one projector is installed in the room :*

1. the common address can be zero (0) or one (1). The standard RCU are setup for common address zero. To change the common address of the RCU, contact a BARCO service center. If it is necessary to program the projector address into the RCU, see chapter 'Controlling'.
2. projector address has to be reprogrammed everytime the battery is changed, the RCU will always switch to the common address.

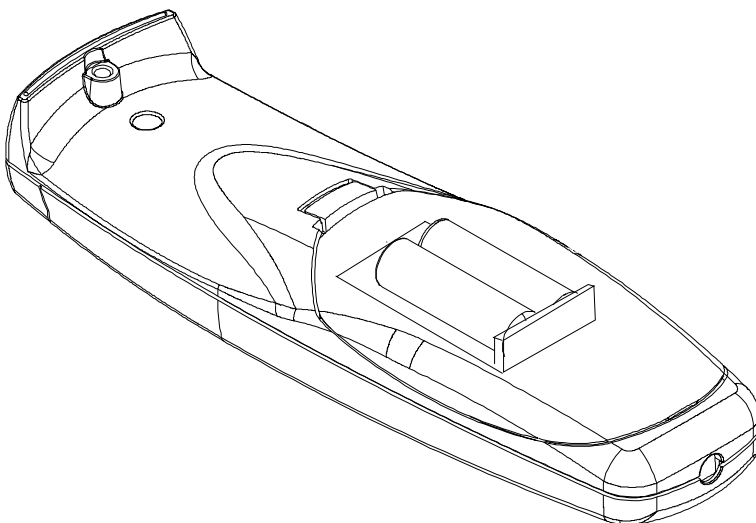
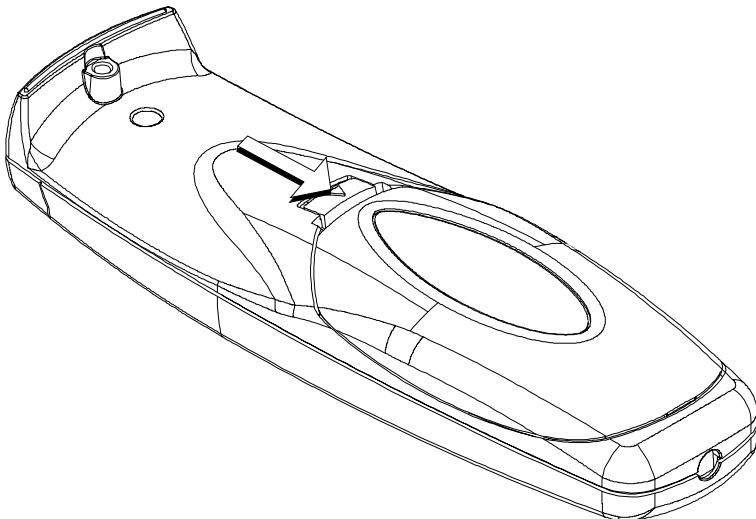

# 2

## INSTALLATION GUIDELINES

Read safety instruction before starting the installation.

### Installation Guidelines

Careful consideration of things such as image size, ambient light level, projector placement and type of screen to use are critical to the optimum use of the projection system.

#### \* Environment

Max. ambient temperature : 40 °C.

Min. ambient temperature : 0 °C.

The projector will not operate if ambient air temperature falls outside this range (0°C- 40°C).

Do not install the projection system in a site near heat sources such as radiators or air ducts, or in a place subject to direct sunlight, excessive dust or humidity. Be aware that room heat rises to the ceiling; check that temperature near the installation site is not excessive.

#### \* Environment condition check

##### Warning: Harmful Environmental Contamination Precaution

A projector must always be mounted in a manner which ensures the free flow of *clean air* into the projectors ventilation inlets. For installations in environments where the projector is subject to airborne contaminants such as that produced by smoke machines or similar (these deposit a thin layer of greasy residue upon the projectors internal optics and imaging electronic surfaces, degrading performance), then it is highly advisable and desirable to have this contamination removed prior to it reaching the projectors clean air supply. Devices or structures to extract or shield contaminated air *well* away from the projector are a prerequisite, if this is not a feasible solution then measures to relocate the projector to a clean air environment should be considered.

Only ever use the manufactures recommended cleaning kit which has been specifically designed for cleaning optical parts, never use industrial strength cleaners on a projectors optics as these will degrade optical coatings and damage sensitive optoelectronic components. Failure to take suitable precautions to protect the projector from the effects of persistent and prolonged air contaminants will culminate in extensive and irreversible ingrained optical damage. At this stage cleaning of the internal optical units will be non-effective and impracticable. Damage of this nature is under no circumstances covered under the manufactures warranty and may deem the warranty null and void. In such a case the client shall be held solely responsible for all costs incurred during any repair. It is the clients responsibility to ensure at all times that the projector is protected from the harmful effects of hostile airborne particles in the environment of the projector. The manufacture reserves the right to refuse repair if a projector has been subject to wantful neglect, abandon or improper use.

#### \* What about ambient light ?

The ambient light level of any room is made up of direct or indirect sunlight and the light fixtures in the room. The amount of ambient light will determine how bright the image will appear. So, avoid direct light on the screen.

Windows that face the screen should be covered by opaque drapery while the set is being viewed. It is desirable to install the projection system in a room whose walls and floor are of non-reflecting material. The use of recessed ceiling lights and a method of dimming those lights to an acceptable level is also important. Too much ambient light will 'wash out' of the projected image. This appears as less contrast between the darkest and lightest parts of the image. With bigger screens, the 'wash out' becomes more important. As a general rule, darken the room to the point where there is just sufficient light to read or write comfortably. Spot lighting is desirable for illuminating small areas so that interference with the screen is minimal.

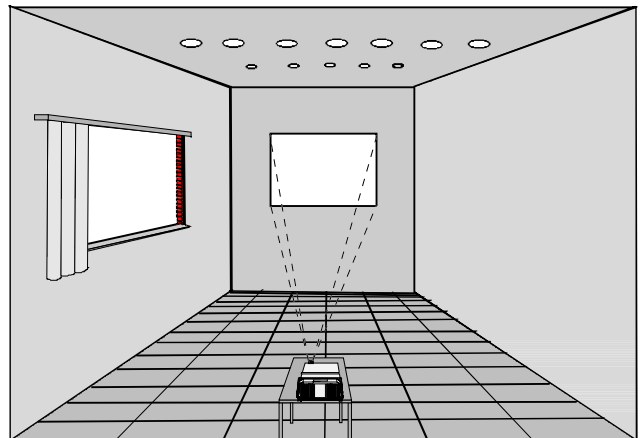

**\* Which screen type?**

There are two major categories of screens used for projection equipment. Those used for front projected images and those for rear projection applications.

Screens are rated by how much light they reflect (or transmit in the case of rear projection systems) given a determined amount of light projected toward them. The 'GAIN' of a screen is the term used. Front and rear screens are both rated in terms of gain. The gain of screens range from a white matte screen with a gain of 1 (x1) to a brushed aluminized screen with a gain of 10 (x10) or more. The choice between higher and lower gain screens is largely a matter of personal preference and another consideration called the Viewing angle.

In considering the type of screen to choose, determine where the viewers will be located and go for the highest gain screen possible. A high gain screen will provide a brighter picture but reduce the viewing angle.

*For more information about screens, contact your local screen supplier.*

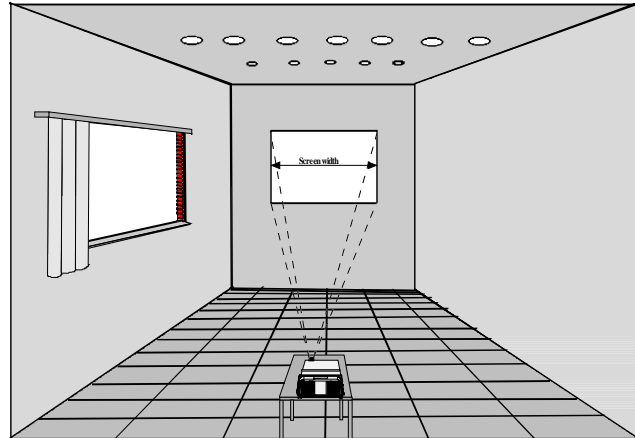

**\* What image size? How big should the image be?**

The projector is designed for projecting an image size (video) from 1.00m (3.3ft) to 6.00m (19.7ft) with a aspect ratio of 4 to 3.

**\* Where to install the projector?**

Only when the lens shift is in it's nominal position.

**Definitions of the Abbreviation on drawings**

B = Distance between ceiling and top of the screen or between floor and bottom of the screen.

A = Correction value, distance between bottom side of projector (without feet) and middle of the lens. Value to be subtracted from B to obtain the correct installation position. (A value is a constant value for all screen widths and type of lenses, A = 124.1 mm or 4.89 inch)

CD = Total distance between projector and ceiling or projector and floor.

SW = Screen width.

SH = Screen height (image height).

PD = Projector Distance, distance between screen and projector.

**Inputs and computer video format input compatibility :**

Some examples :

- VIDEO and S-VIDEO
- COMPONENT VIDEO
- RGB ANALOG with STANDARD SYNC (SYNC ON GREEN or SEPARATE SYNC)
- RGB ANALOG with TRI-LEVEL SYNC (SYNC ON GREEN or SEPARATE SYNC)
- VGA : 640 x 480 pixels
- MAC : 640 x 480 pixels
- Super VGA : 800 x 600 pixels
- XGA : 1024 x 768 pixels
- sources up to 1280 x 1024 pixels
- Sources with pixel clock < 135 MHz

**Lens type selection.**

- a) Determine the required screen width.
  - b) Determine the approximate position of the projector in the projection room with regard to the screen and measure the projector-screen distance (PD).
  - c) Use the lens formulas in appendix B to find the best corresponding PD with regard to the measured projector-screen distance for the required screen width.
- The desired lens is determined (the order number is given in the tabel in the same appendix B). Start the installation procedure for the projector as described in the manual.

OFF-Axis installation

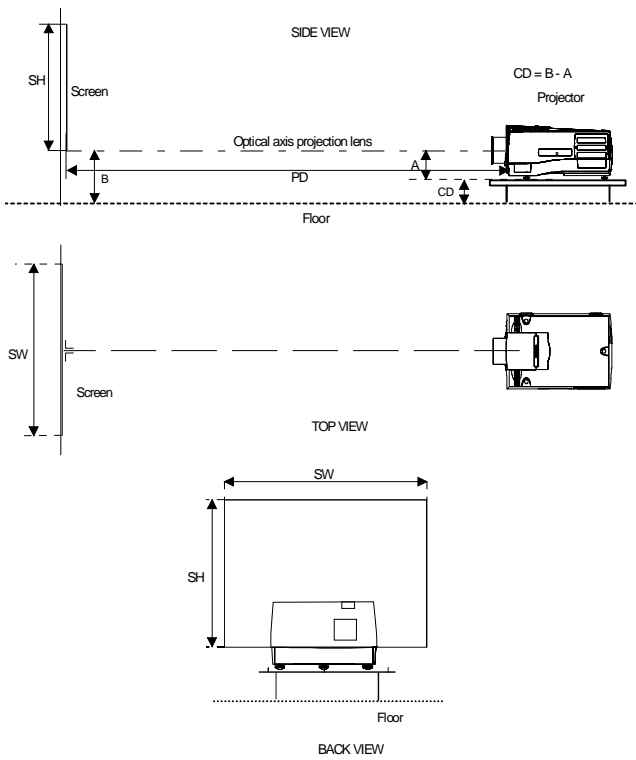

ON-Axis installation

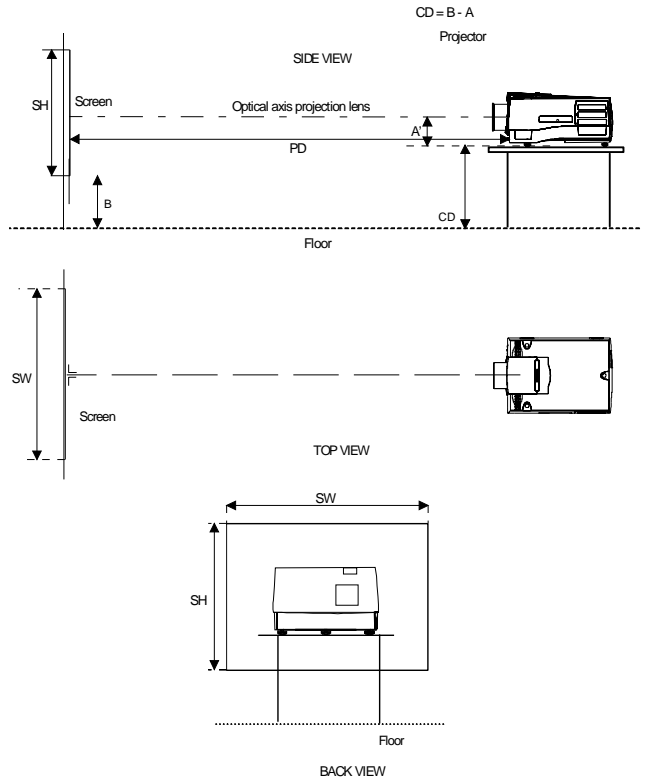

\* How to install a projection lens?

The projector is supplied without any lens.

The following lenses are available, or will become available (contact a Barco service center) as an option :

QFD(1.27:1)	R9840400
QFD(2.5:1)	R9840290
QFD(1.4-2.1:1)	R9840380
QFD(2.1-3.0:1)	R9840390
QGD(3.5-4.5:1)	R9840060
QFD(4.5-6.0:1)	R9840100
QFD(7:1)	R9840410



## Installation Guidelines

---

### How to install the lens?

1. Take the lens out of its packing material.
2. Open the lens cover of the projector by pivoting it up and take it off.
3. Open both lens locks (B) by pulling them backwards. Unlock first by pulling clip (A) forwards.
4. Put the lens on the lens holder.
5. Fix the lens by closing both locks (B) until they are secured.
6. Plug the wires of motor unit into the connector (C).
7. Re-install the lens cover.

image 1  
image 2

image 3  
image 3  
image 4

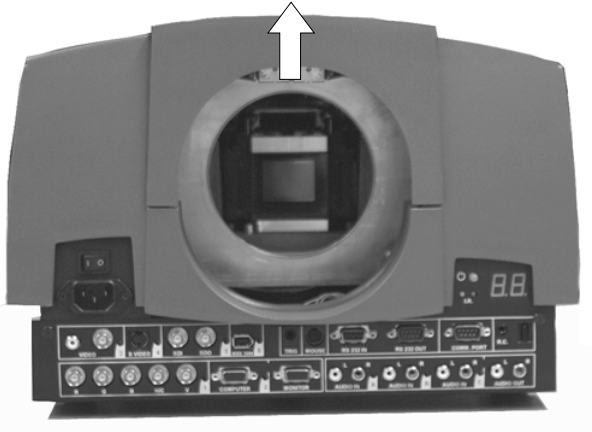

Image 1

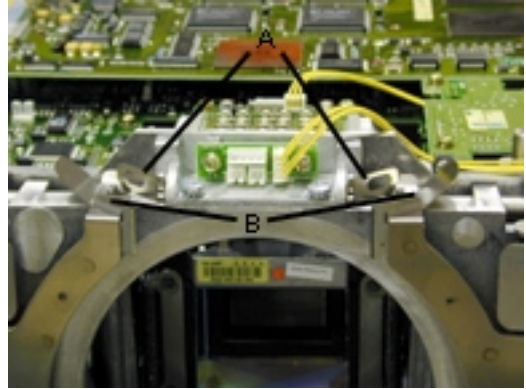

Image 2

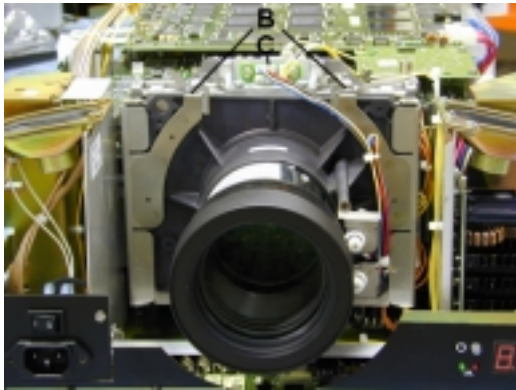

Image 3



Image 4

# 3

## LOCATION AND FUNCTIONS OF CONTROL

### Front Panel Terminology

The front panel terminology can be divided into 'Source & power connections' and 'Communication connections'.

#### Source & Power Connections

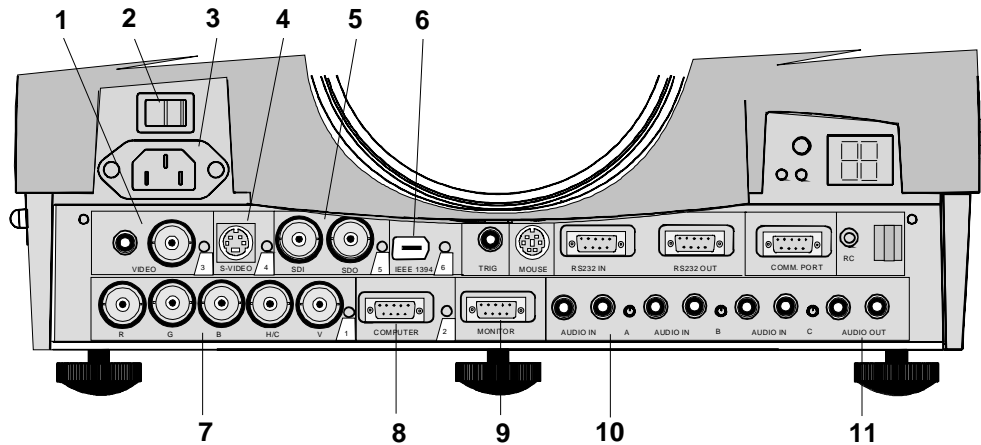

- 1 **Video input:** 1inch or 1 BNC connector, no loop through.
- 2 **Power switch :** '1' = on, '0' = off
- 3 **Power input :** autoranging from 90 to 240 Vac.
- 4 **S-Video**
- 5 **SDI and SDO :** serial digital input and loop trough output. 2 x BNC terminals.
- 6 **IEEE 1394 :** not yet implemented.
- 7 **5-cable input :** can be software switched between Video, S-Video, RGB analog or Component Video.
- 8 **Computer input**
- 9 **Monitor output :** the monitor of your computer can be connected to this output if your computer is connected to the computer input.
- 10 **Audio inputs :** 3 audio inputs. Each audio input can be associated with arbitrary input.
- 11 **Audio output**

Communication Connections

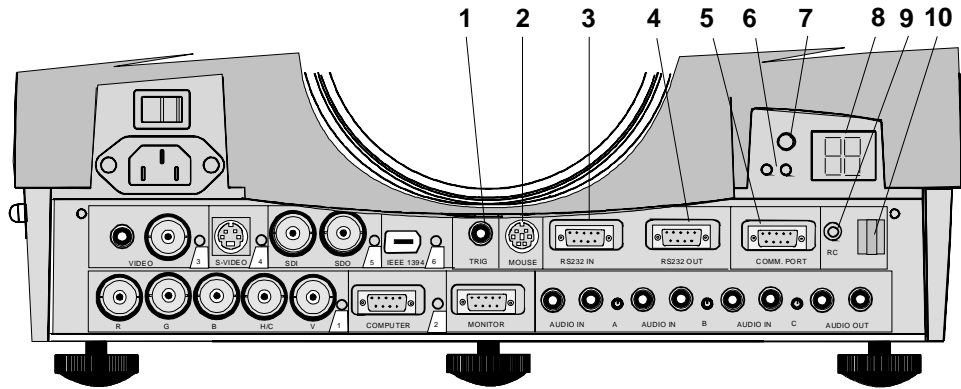

- 1 **TRIG** : output voltage of 5 V when projector is on.
- 2 **MOUSE** : mouse output to be connect to the mouse input of a computer. The computer can now be controlled via the Executive Remote Control Unit.
- 3 **RS232 IN** : to allow communication with external computer, e.g. IBM PC or compatible, Macintosh ...
- 4 **RS232 OUT** : used to connect to next projector, RS232IN plug (communication link for PC or MAC to the next projector).
- 5 **Communication port** : allows communication with the 800 peripherals.
- 6 **IR-Acknowledged** : IR signals are recognized.  
**IR-Received** : IR signals are received but not recognized by the projector.
- 7 **Projector mode indication** : indicates the status of the projector.  
  - Light off : power switch is not pressed.
  - Red light : power switch is pressed, projector in stand by mode.
  - Green light : projector in operational mode.
- 8 **Diagnostics code** :  
  - a) source number
  - b) error code : a two digit error code is displayed when something goes wrong inside the projector.
- 9 **Remote** : remote input for wired remote control.
- 10 **IR receiver** : receiver for control signals transmitted from the RCU.

**Control Panel Terminology**

The projector can be controlled by the local keypad or by the remote control unit.

a. Local keypad

The local keypad is located on the backside of the projector.



b. Remote control

This remote control includes a battery powered infrared (IR) transmitter that allows the user to control the projector remotely. This remote control is used for source selection, control, adaptation and set up. It includes automatic storing of :

- picture controls (Brightness, Sharpness...)
- settings

Other functions of the remote control are :

- switching between standby and operational mode.
- switching to "pause" (blanked picture, full power for immediate restarting)
- direct access to all connected sources.

Remote Control (RCU)

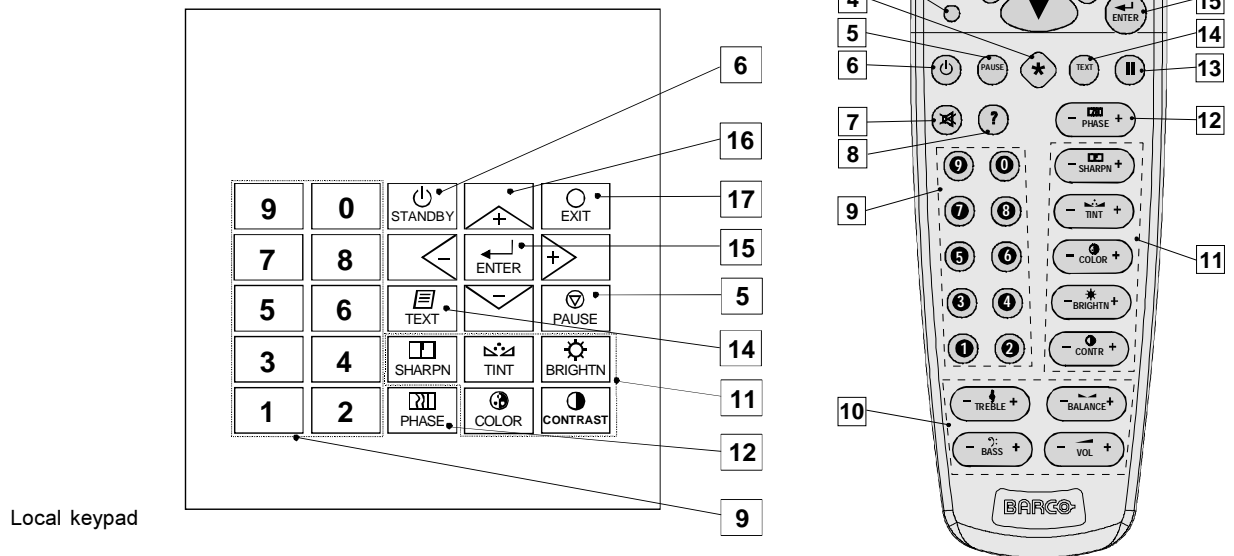

Terminology

- 1 **Function keys** : user programmable keys with functions for direct access.
- 2 **ADJ.** : to escape the adjustment mode.
- 3 **Address key** (recessed key), to enter the address of the projector (between 0 and 9). Press the recessed address key with a pencil, followed by pressing one digit button between 0 and 9.
- 4 **Selection key** : to direct access the zoom/focus/shift functions.
- 5 **PAUSE** : to stop projection for a short time, press 'PAUSE'. The image disappears but full power is retained for immediate restarting.
- 6 **STBY** : stand-by button, to start projector when the power switch is switched on and to switch off the projector without switching off the power switch.  
  
*Attention : Switching to Stand-by.*  
  
*When the projector is running and you want to go to stand-by, press the stand-by key for 2 seconds until the message 'Saving data, please wait' is displayed. Do not press any longer on the stand-by key otherwise the projector will restart.*
- 7 **Mute** : to interrupt the sound reproduction.
- 8 **?** : Auto image, to center the image on the active LCD surface.
- 9 **Digit buttons** : direct input selection.
- 10 **Audio controls** : use these buttons to obtain the desired sound level (see also 'Controlling').
- 11 **Picture controls** : use these buttons to obtain the desired picture analog level (see also 'Controlling').
- 12 **PHASE** : used to remove the instability of the image.

- 13 **FREEZ** : press to freeze the projected image.
- 14 **TEXT** : when adjusting one of the image, e.g. controls during a meeting, the displayed bar scale can be removed by pressing 'TEXT' key first. To re-display the bar scale on the screen, press 'TEXT' key again.
- 15 **ENTER** : to start up the adjustment mode or to confirm an adjustment or selection in the adjustment mode.
- 16 **Cursor Keys** (on RCU) or **'+' and '-' keys** (cursor keys) on the local keypad : to make menu selections when in the adjustment mode or to zoom/focus when the direct access is active.

Comparison between the cursor keys and the use of the '+' and '-' keys on the local keypad :

RCU	=	local keypad
cursor key up	=	'+' key up
cursor key down	=	'-' key down
cursor key right	=	'+' key right
cursor key left	=	'-' key left

Use the **'+' and '-' keys** (cursor keys) : to increase or decrease the analog level of the image controls when they are first selected.

- 17 **EXIT** : to leave the adjustment mode or to scroll upwards when in the adjustment mode.
- 18 **RC operating indication** : lights up when a button on the remote control is pressed. (This is a visual indicator to check the operation of the remote control)

# 4

## INSTALLATION SET UP

### Configuration

The projector can be installed to project images in four different configurations : front/table, front/ceiling, rear/table and rear/ceiling.

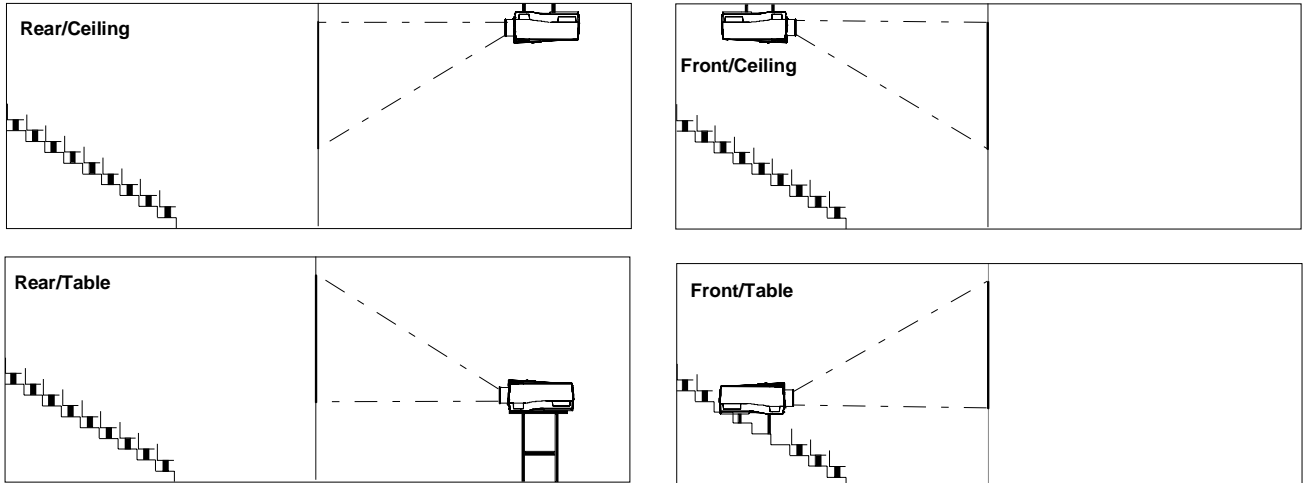

Changing the configuration :

To change the configuration of the projector, proceed as follow :

- 1 Press ENTER to start up the adjustment mode.
- 2 Press the cursor key  $\uparrow$  or  $\downarrow$  to select 'Installation'.
- 3 Press ENTER to display the Installation menu.
- 4 Press the cursor key  $\uparrow$  or  $\downarrow$  to select 'Configuration'.
- 5 Press ENTER to display the Configuration menu. The actual installed configuration will be highlighted.
- 6 Press the cursor key  $\uparrow$  or  $\downarrow$  to select the corresponding configuration.
- 7 Press Adjust to leave the adjustment mode.

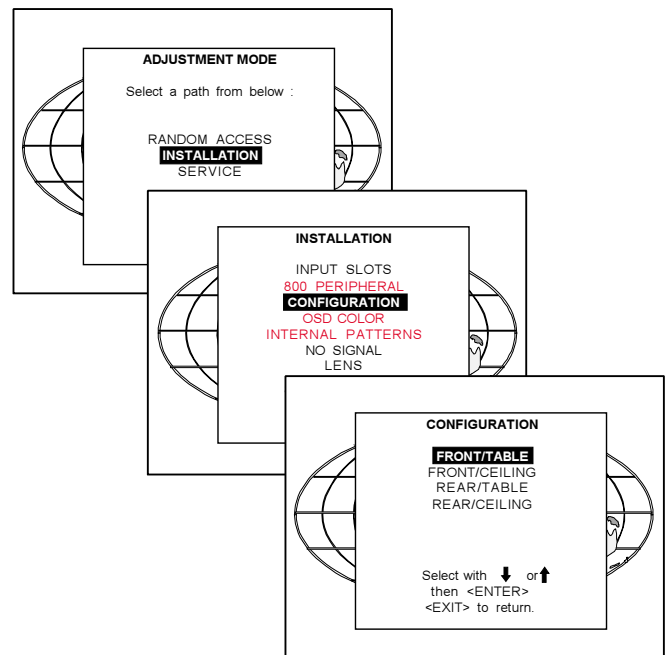

# 5

## CONNECTIONS

### Power connection

#### AC Power (mains) cord connection

Use the supplied power cord to connect your projector to the wall outlet. Plug the female power connector into the male connector at the front of the projector.

The power input is auto-ranging from **90 to 240 VAC**.

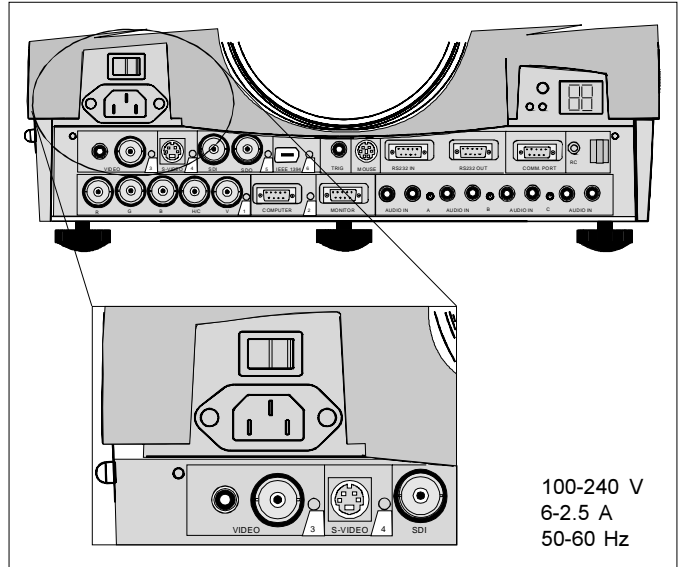

### Fuses

#### Warning

- For continued protection against fire hazard :
- refer replacement to qualified service personnel
  - ask to replace with the same type of fuse.
- Fuse type : T10 AH/250V

### Switching on

Use the power switch to switch on.

When '0' is visible, the projector is switched off.

When '1' is visible, the projector is switched on.

When switching on with the power switch, the projector starts in the stand by mode. The projector mode indication lamp is red.

To start image projection :

- press the 'Stand by' button once on the local keypad or on the remote control. The projector mode indication lamp will be green.
- press a digit button to select an input source. The projector mode indication lamp will be green.

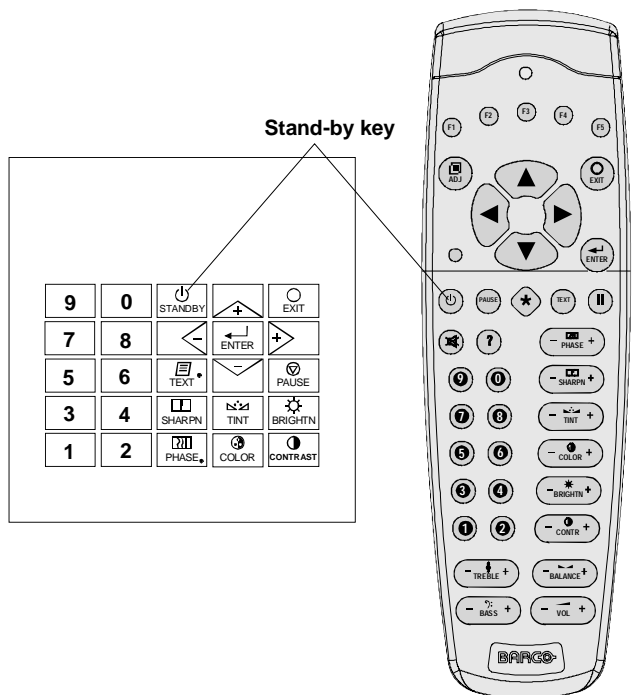
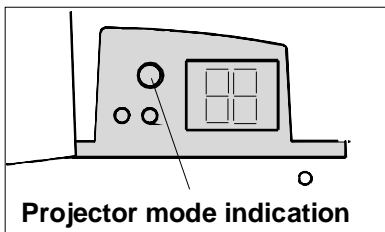

## Lamp Run Time

When the total run time of the lamp is 720 hours or more, the following warning message will be displayed for 1 minute. This warning message will be repeated every 30 minutes. Press EXIT to remove the message before the minute is over.

When the total run time of the lamp is 750 hours or more, the following warning message, with the exact run time is displayed on the screen.

*Lamp run time is 750 hours. Operating the lamp longer than 750 hours may damage the projector. Please replace the lamp.*

When OK (ENTER) is pressed to go on, the warning will be repeated every 30 min.

The total lifetime of the lamp for a safe operation is 750 hours max. Do not use it longer. Always replace with a same type of lamp. Call a BARCO authorized service technician for lamp replacement.

## Lamp Run Time Warning

**Using a lamp for more than 750 hours is dangerous as the lamp could explode.**

## Switching to Stand-by.

When the projector is running and you want to go to stand-by, press the stand-by key for 2 seconds until the message 'Saving data, please wait' is displayed. Do not press any longer on the standby key otherwise the projector will restart.

## Switching Off

To switch off:

- First press **STANDBY** key for 2 seconds. When the message 'Saving data, please wait' is displayed, do not press any longer on the standby key otherwise the projector will restart. Let cool down the projector at least 10 min.
- Switch off the projector with the power switch.

## Switching to Stand-by Warning

**When switching to standby, it is possible to restart within the first 5sec.. When not restarted within these first 5 sec., the projector waits for 1 min. to restart again. During this period the LED display will show a jumping square with a dash. After one minute, two dashes will be displayed and the projector can restart.**

## Input Connections

- Input facilities :
- Video
  - S-Video
  - 5-cable input
  - Computer
  - Serial digital input
  - IEEE 1394 (not yet active)

Input Selection :

This can be manually or automatically.

When 'automatic' is selected in the Input slots menu, by starting up the projector, it searches for an input source by scanning the inputs one by one. If only one source is found, this source will be projected. If different sources are found, the priority is as follow :

1. Video
2. S-Video
3. 5 Cable input
4. Computer input

SDI input and IEEE input are never automatically selected.

Note : When a RCVDs is connected to the projector, the 'Automatic' selection is disabled.

Set up of the input selection :

- 1 Press **ENTER** to start up the adjustment mode.
- 2 Press the cursor key **↑** or **↓** to select 'Installation'.
- 3 Press **ENTER** to display the Installation menu.
- 4 Press the cursor key **↑** or **↓** to select 'Input Slots'.
- 5 Press **ENTER** to display the Input slots menu.
- 6 Press the cursor key **↑** or **↓** to select 'Input Slots'.
- 7 Press **ENTER** to toggle between [Manual] or [Automatic].
- 8 Press **EXIT** several times to leave the adjustment mode.

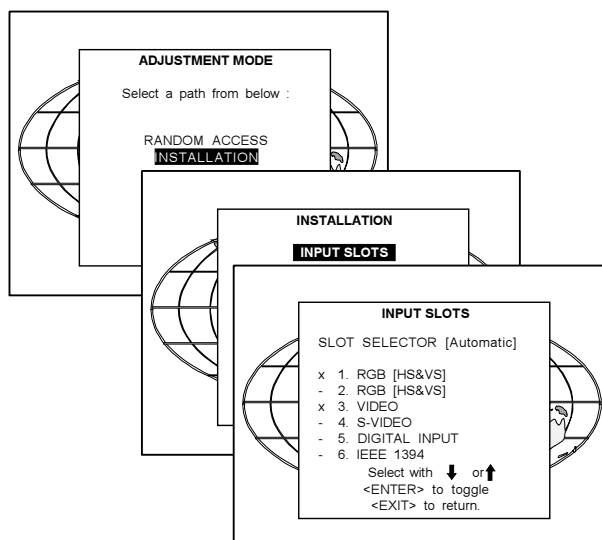
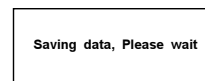
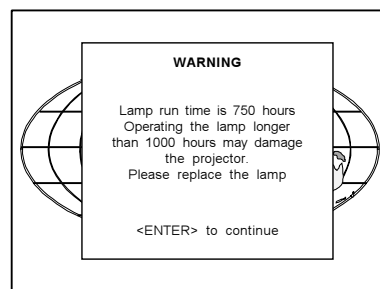
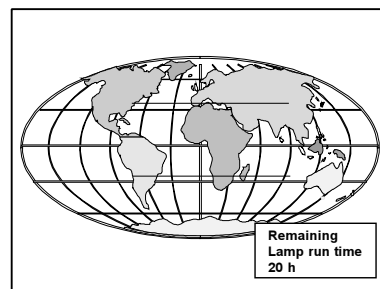



**Connections**

Use of a RCVDS05 or VS05 :

When using a RCVDS05, it is recommended to use a 5-cable output module in the RCVDS. The outputs of this module have to be connected to the 5 cable input (slot 1) of the projector.

To switch the projector in the 5-cable mode see chapter 'Installation mode'.

**5-cable Input Slot (slot 1)**

Slot 1 has 5 BNC input terminals.

The following signals can be connected to these BNC connectors :

Connector name	R	G	B	H	V
Input signal					
RGBHV	R	G	B	H	V
RGBS	R	G	B	S	-
RGsB	R	Gs	B	-	-
Composite Video	-	Video	-	-	-
Super Video	-	Y	-	-	C
Component Video - SS	R-Y	Y	B-Y	S	-
Component Video - SOY	R-Y	Ys	B-Y	-	-

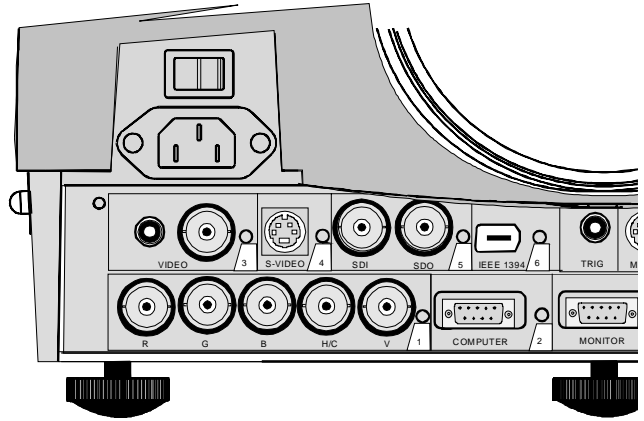

**Slot 1 selection :**

Key in 1 on the RCU or the local keypad.

**Configuration of the 5-cable input :**

The configuration has to be done on the 'Input slot' menu.

To change the signal format :

- 1 Press **ADJUST** or **ENTER** key to start up the Adjustment mode.
- 2 Push the cursor key **↑** or **↓** to select *Installation*
- 3 Press **ENTER**.
- 4 Press the cursor key **↑** or **↓** to select 'Input Slots'
- 5 Press **ENTER**. The internal system will scan the inputs and displays the result in the 'Input Slots' menu.
- 6 Push the cursor key **↑** or **↓** to select the first slot.
- 7 Press **ENTER** key to toggle the input signal priority.

**Possible indication :**

- RGB [HS&VS]** = RGB analog signals, separate sync is horizontal and vertical sync.
- RGB CS** = RGB analog signals, separate sync is composite sync.
- RGB CV** = RGB analog signals, separate sync is composite video or tri-level sync.
- RGB-SOG** = RGB analog signals, sync on green is composite sync.
- COMPONENT VIDEO - CS** = separate sync is composite sync.
- COMPONENT VIDEO** = component video with composite sync on Y or composite tri-level sync on Y.
- VIDEO**
- S-VIDEO**

When using an RCVDS 05 with a 5 cable output module, connect these 5 cables to this 5-cable input slot (slot1) of the projector. All sources of the RCVDS can now be accepted by the projector.

**Audio connection :**

Connect the audio input to one of the 3 audio inputs. See 'audio configuration' in this chapter for more explanation.

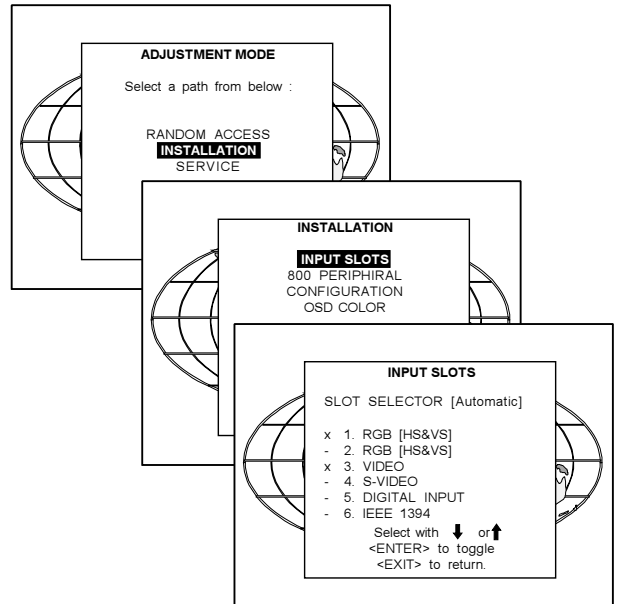

### Computer input/Monitor output

Connect the output of the graphical card of the computer to the Computer input of the projector (connection < 60 cm) or insert an interface between the output of the computer and the input of the projector.

Connect the monitor of the computer to the monitor output of the projector.  
This monitor output is only available when the computer input is used as input.

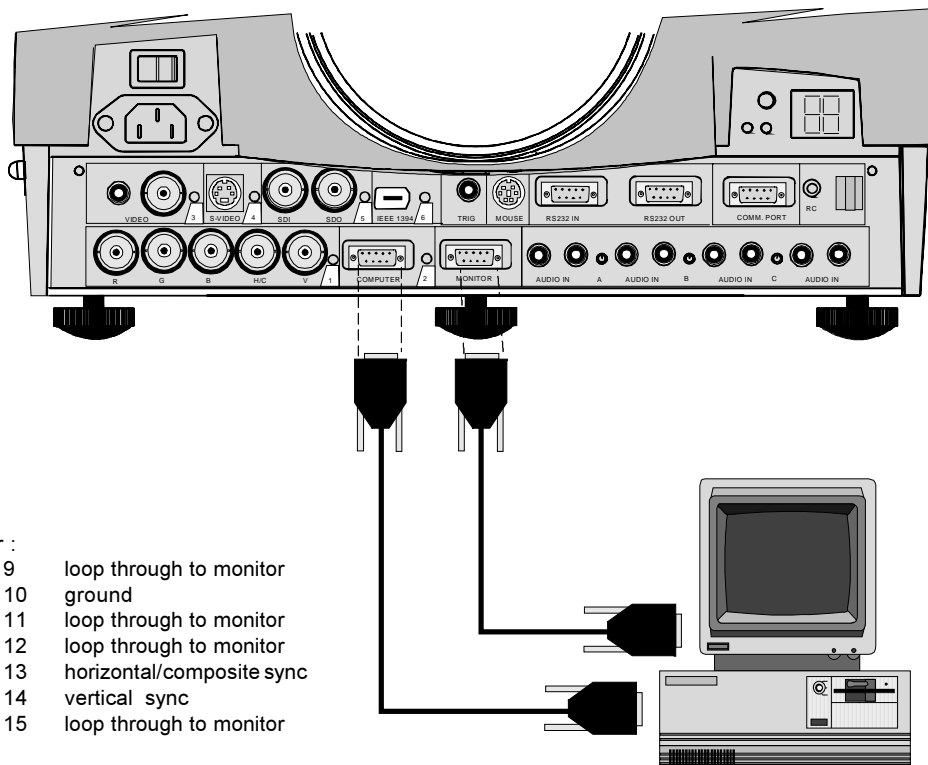

Pin configuration of the D15 connector :

- |   |        |    |                           |
|---|--------|----|---------------------------|
| 1 | RED    | 9  | loop through to monitor   |
| 2 | GREEN  | 10 | ground                    |
| 3 | BLUE   | 11 | loop through to monitor   |
| 4 | GREEN  | 12 | loop through to monitor   |
| 5 | ground | 13 | horizontal/composite sync |
| 6 | ground | 14 | vertical sync             |
| 7 | ground | 15 | loop through to monitor   |
| 8 | ground |    |                           |

### Slot 2 selection :

Key in 2 on the RCU or the local keypad.

### Video Input

#### Input signal :

Composite video signals from a VCR, OFF air signal decoder, etc...

1 x BNC or cinch 1.0Vpp ± 3 dB

No loop through.

### Slot 3 Selection :

Key in 3 on the RCU or the local keypad.

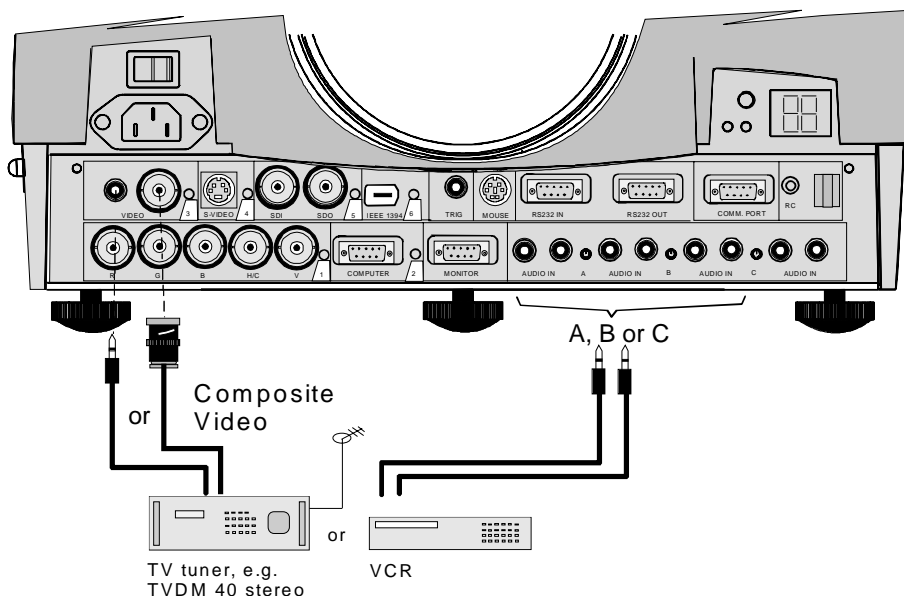

S-Video Input

Input signal :

Separate Y-luma/C-chroma signals for higher quality playback of Super VHS-signals.

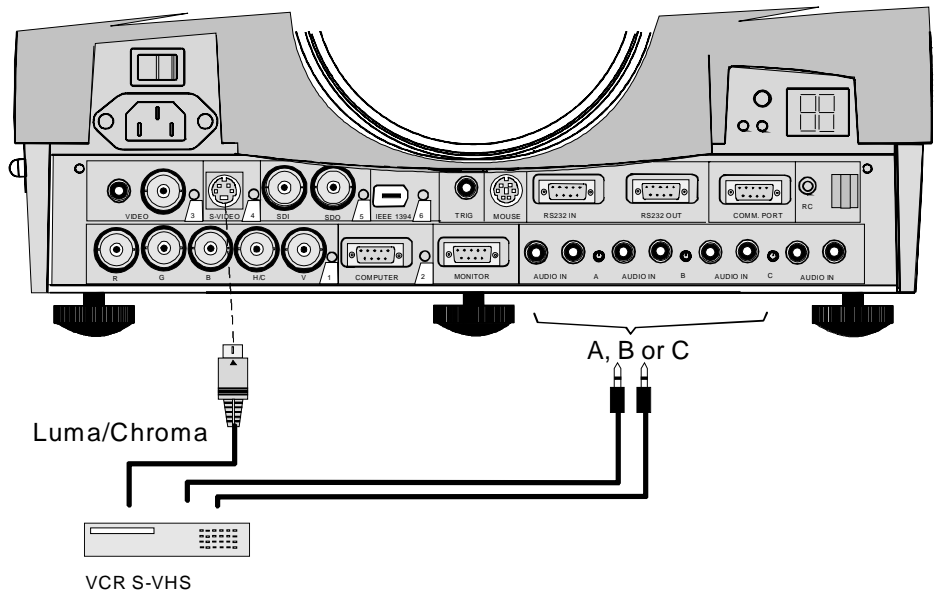

Pin configuration mini DIN plug :

- 1 ground luminance
- 2 ground chrominance
- 3 luminance 1.0Vpp ± 3 dB
- 4 chrominance 282 mVpp ± 3 dB

Slot 4 Selection :

Key in 4 on the RCU or the local keypad.

Serial Digital Input / Serial Digital Output

Optional input/output

Full compatibility with digital Betacam, or digital video sources.

This avoids the need for analog processing anywhere in the video production chain and guarantees the ultimate image quality.

An active loop through of the SDI input signal is provided for monitoring or for double or triple stacking applications.

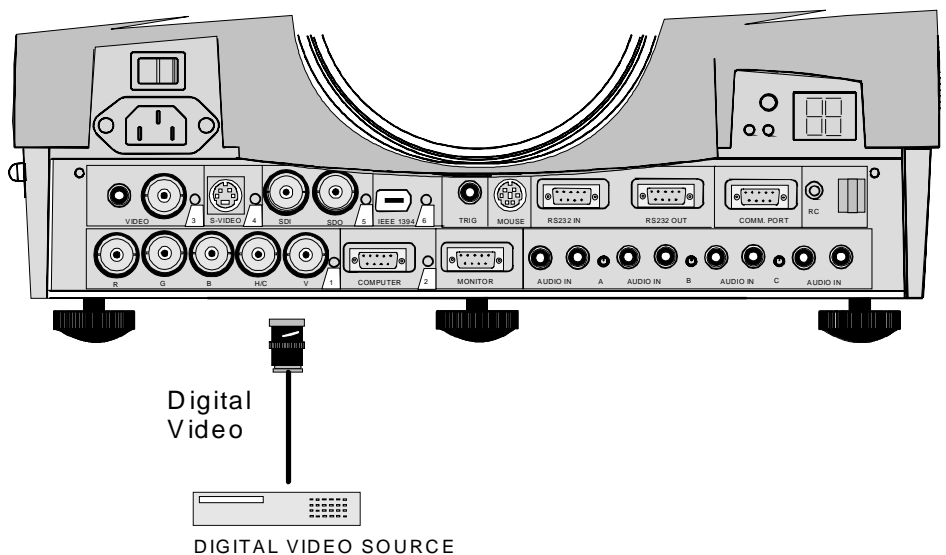

**connections :**

1 x BNC input and 1 x BNC output.  
The input is always 75  $\Omega$  terminated. The output impedance of the SDO is 75  $\Omega$ .

**Slot 5 Selection :**

Key in 5 on the RCU or the local keypad.

**Note :** *When a RCVDS05 is connected to the projector, the SDI input is available by keying in 85 on the RCU.*

**IEEE 1394 Input**

Input not yet implemented.

**Communication Connections**

The following communication connections are available :

- RS232 in / RS232 out.
- Comm port for communication with peripheral.
- RC for remote cable connection with the RCU.
- MOUSE to control a PC with the projector remote control.
- TRIG : output voltage to control another device.

**RS232 in / RS232 out**

To connect a Computer, e.g. IBM PC (or compatible), Apple Macintosh to the RS 232 input of the projector to allow communicate between the computer and the projector.

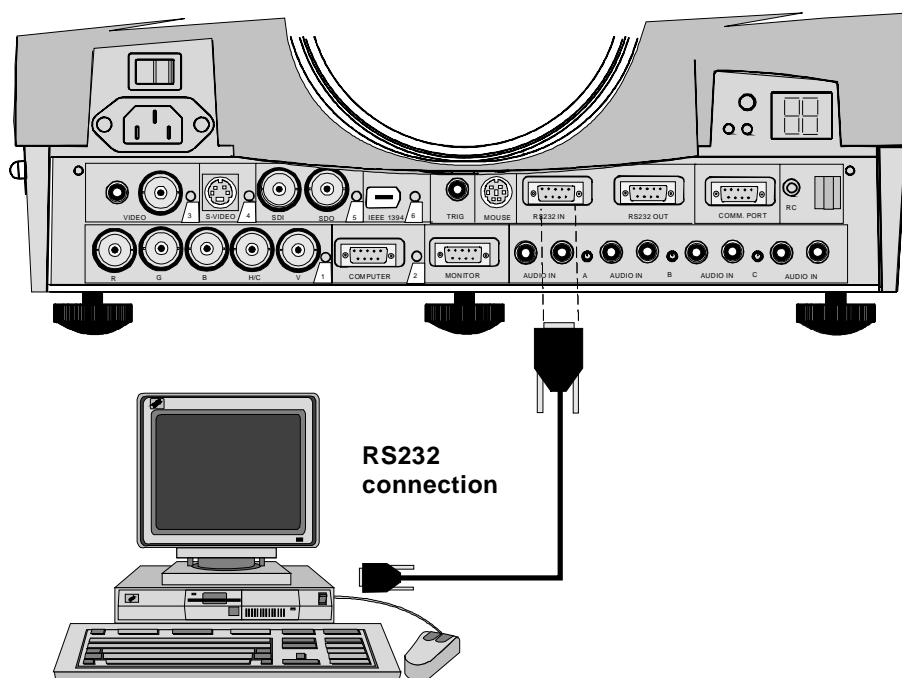
**Applications :**

- a) remote control :
  - easy adjustment of projector via IBM PC (or compatible) or MAC connection.
  - allow storage of multiple projector configurations and set ups.
  - wide range of control possibilities.
  - address range from 0 to 255.
- b) data communications :
  - sending data to the projector or copying the data from the projector to a hard memory device (hard disc, floppy, etc.).

**Set up of the Baud Rate for Communication with a Computer :**

See 'Change Baudrate PC' in chapter 'Service mode'.

### Communication port for communication with peripherals

This port can be configured to accept PPM or RC5 coded signals.  
To change the port configuration see 800 Peripherals in Chapter Installation.

#### Connecting a RCVDS 05 to the projector.

- Up to 20 inputs with the RCVDS 05 and 90 inputs when RCVDS's are linked via the expansion module.
- Serial communication with the projector.
- Remote control buttons on the RCVDS to control the projector (source selection and analog settings).
- The selected source number will be displayed on a 2 digit display and the selected input module will be indicated with a LED on the rear.

For more information about the use of the RCVDS 05, consult the owner's manual of the RCVDS05, order number : R5975765.

#### Connecting a VS05 to the projector

The VS05 can switch up to 5 Composite Video sources, 3 Super Video sources and 1 RGB analog or component video source to the projector.  
In addition, the audio signal proper to the source, can be switched to an audio amplifier or the audio input of the projector.  
Order number : R9827890

For more information about the use of the VS05, consult the VS05 owner's manual, order number : R5975245.

#### TRIG Output

5 V output voltage to trigger an external device (max. 10mA).  
This voltage is available when the projector is on.

#### MOUSE

Mouse function is only available with the Executive Remote Control (Order number : R9829960). The computer can then be controlled via the projector.

To activate this mouse function, handle as follow :

- 1 Start up your computer with the computer mouse plugged in. The mouse driver should be loaded.
- 2 Unplug the computer mouse without switching off the computer.
- 3 Plug the delivered cable between the mouse input of the computer and the mouse output of the projector.
- 4 Computer can now be controlled with the executive remote control.

For more information about the mouse buttons or functions, consult the owner's manual of the Executive Remote Control.

Warning : before swithing off, disconnect first the mouse cable.

Mouse functions :

Left click, right click or double click are the same as for a traditional mouse.

For Click and drag : push for 2 seconds on the left (right) mouse button, the move the mouse arrow with the mouse navigator and click again very short on the left (right) mouse button to interrupt the drag function.

### Audio Connections

Three audio inputs and one audio output are available. Each audio input can be associated with an input source using the control software of the projector. e.g. source 1 can be locked with audio input B.

Locking an audio input to a source input :

- 1 Press **ENTER** to start up the adjustment mode.
- 2 Press the cursor key **↑** or **↓** to select 'Random Access'.
- 3 Press **ENTER** to display the Random Access menu.
- 4 Press the cursor key **↑** or **↓** to select 'Audio Tuning'.
- 5 Press **ENTER** to display the Audio Tuning menu.
- 6 Press the cursor key **↑** or **↓** to select 'Video-Audio lock'.
- 7 Press the cursor key **←** or **→** to select the desired source input.
- 8 Press **ENTER** to toggle between [A], [B] or [C].
- 9 Press several times **EXIT** or **ADJUST** to return to the operational mode.

See also 'Video - Audio lock' in chapter 'Random Access Adjustment Mode'.

# 6

## CONTROLLING

The projector can be controlled with

- a. The RCU
- b. The hardwired RCU (cable is not included)
- c. The local keypad.

Controlling the projector with the RCU and the hardwired RCU is equal.

### How to use the RCU?

a) Point the front of the RCU to the reflective screen surface.

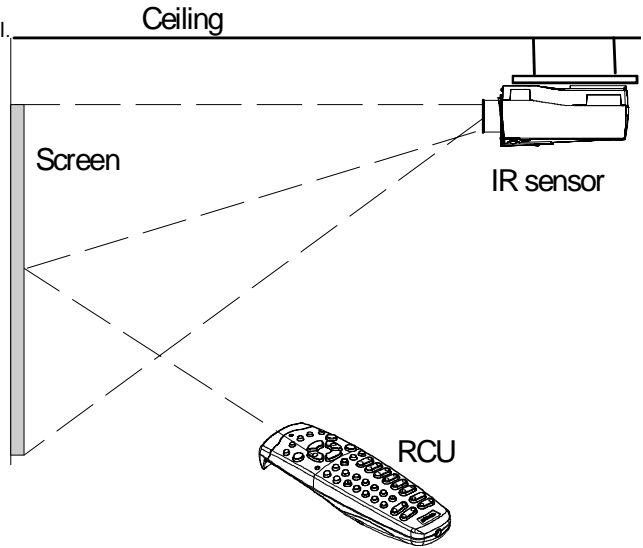

b) RCU used in a hardwired configuration.

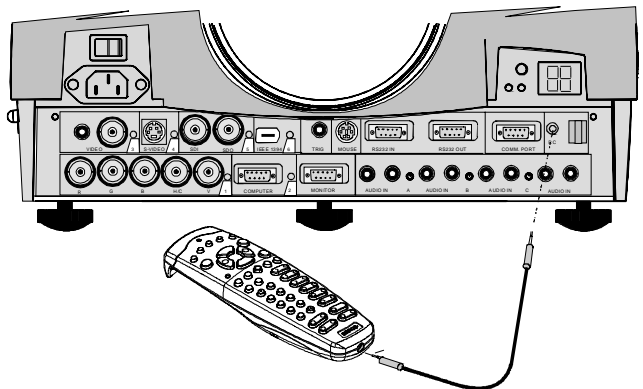

Plug one end of the remote cable in the connector on the bottom of the RCU and the second side in the connector in the front panel of the projector labelled 'RC'.

c) Point the front of the RCU directly at one of the IR sensors of the projector.

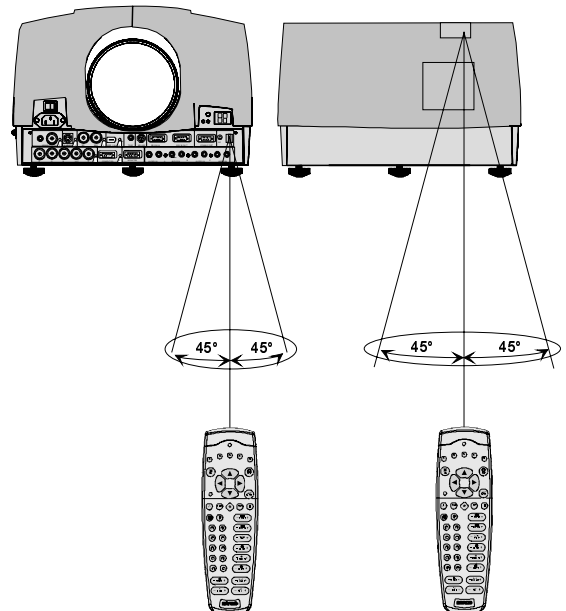

When using the wireless remote control, make sure you are within the effective operating distance (30m, 100ft in a straight line). The remote control unit will not function properly if strong light strikes the sensor window or if there are obstacles between the remote control unit and the projector IR sensor.

## Projector address

### a. Software set up of the projector address.

See 'Change projector address' in chapter 'Service mode'.

### b. How to control the projector or projectors.

The projector's address may be set to any value between 0 and 255. When the address is set, the projector can be controlled now :

- RCU for addresses between 0 and 9.
- computer, e.g. IBM PC (or compatible), Apple MAC, etc. for addresses between 0 and 255.

Note : a projector will respond to a RCU set to the common address ('0' or '1') regardless of what address is set in the projector itself.

### c. Using the RCU.

The RCU is default programmed with address 0 or 1, 'common address'. With that 'common address' programmed into the RCU, every projector, without exception will listen to the commands given by this RCU. If it is necessary to control a specific projector, than enter the projector address into the RCU (only when that address is between 0 and 9). The projector with the corresponding address will listen to that specific RCU.

## Common Address

Every projector has a common address '0' or '1'. The choice between '0' and '1' can be selected in the Service mode.

## Displaying a Projector Address.

Press the **ADDRESS** key (recessed key on the RCU) with a pencil. The projector's address will be displayed in a 'Text box'. This text box disappears after a few seconds.

To continue using the RCU with that specific address, it is necessary to enter the same address with the digit buttons (address between 0 and 9) within 5 seconds after pushing the address key. For example : if the Address key displays projector address 003, then press "3" digit button on the RCU to set the RCU's address to match the projector's address. Do not press 003 digits. This will address the remote control to '0' and control all projectors in the room.

If the address is not entered within 5 seconds, the RCU returns to its default address (zero address) and control all projectors in the room.

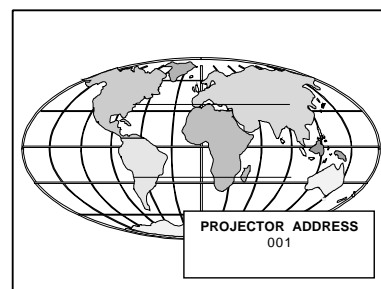

## How to Program an Address into the RCU?

Press the **ADDRESS** key (recessed key on the RCU) with a pencil and enter the address with the digit buttons within 5 seconds after pushing the address key. That address can be any digit between 0 and 9.

## Picture controls with direct access.

When an image control is pressed, a text box with a bar scale, icon and function name of the control, e.g. 'brightness...' appears on the screen (only if text is ON). See example screen. The length of the bar scale and the value of the numeric indication indicate the current memorized setting for this source. The bar scale changes as the control stick on the RCU is pressed or the + or - buttons on the local keypad.

### Brightness Control

A correct '*brightness*' setting is important for good image reproduction.  
Use the + button for a higher brightness.  
Use the - button for a lower brightness.

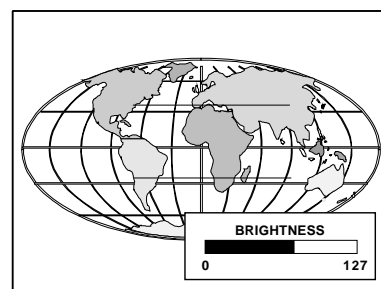

### Contrast Control

A correct '*contrast*' setting is important for good image reproduction.  
Adjust the contrast to the level you prefer, according to room lighting conditions.  
Use the + button for a higher contrast.  
Use the - button for lower contrast.

### Color Saturation

Color saturation is only active for Video and S-Video. Adjust the color intensity of the picture.  
Use the + button for richer colors.  
Use the - button for lighter colors.

### **Tint Control**

Tint is only active for Video and S-Video when using the NTSC 4.43 or NTSC 3.58 system.

Use the + button

Use the - button.

### **Sharpness Control.**

Use the + button for a sharper picture.

Use the - button for a softer picture.

### **Phase Control**

Use the control disc to adjust the phase.

### **Freez key**

Press Freez to freeze the displayed image.

### **Sound controls with direct access.**

When a sound control is pressed, a text box with a bar scale, icon and function name of the control, e.g. 'volume...' appears on the screen (only if text is ON). See example screen. The length of the bar scale indicates the current memorized setting for this source. The bar scale changes as the + or - buttons of the control are pressed.

The picture controls can only be adjusted with the RCU.

### **Volume Control**

Volume control adjusts the volume.

Use the + button for a higher volume.

Use the - button for a lower volume.

### **Bass Control**

Bass control adjusts the bass level (low tones).

Use the + button for more low tones.

Use the - button for less low tones.

### **Treble Control**

Treble control adjusts the treble level (high tones).

Use the + button for more high tones.

Use the - button for less high tones.

### **Balance Control**

Is only effective if a external amplifier with loudspeakers is connected to the audio output.

The balance control adjust the sound level between the left and the right box.

Use the + button for a higher sound level on the right box than on the left one.

Use the - button for a higher sound level on the left box than on the right one.

### **The Pause key.**

When the Pause key is pressed, the image projection is stopped, a blue screen will be displayed and the projector remains with full power for immediate restart. The sound is not interrupted.

The display on front of the projector will show a "P".

To restart the image :

- 1 press pause key,
- 2 press exit key or
- 3 select a source number.



## The Selection key.

When the Selection key is pressed, the zoom/focus/shift menu will be displayed immediately.  
To focus or zoom the image :

- 1 Push the **↑** or **↓** key to zoom and **←** or **→** key to focus the image.
- 2 When finished, press **EXIT** to return.

To shift the image :

- 1 Press **ENTER** to switch to the shift menu
- 2 Push the **↑** or **↓** key to shift the image up or down and **←** or **→** key to shift the image left or right.
- 3 When finished, press **EXIT** to return

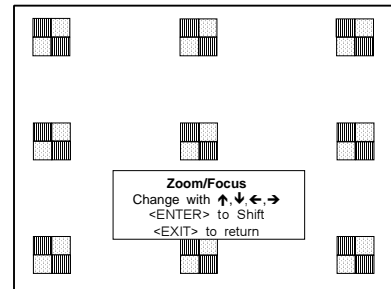

## 7

## START UP OF THE ADJUSTMENT MODE

### Adjustment Mode

All source parameters, picture and audio tuning, and geometry are made while in the 'Adjustment Mode'. Press the **ADJUST** or **ENTER** key to enter the 'Adjustment mode'.

You are now in the 'Adjustment Mode'.

- 1 The cursor key (RCU) or '+' or '-' keys (local keypad) are used to make menu selections and also for adjustments.
- 2 The **ENTER** and **EXIT** keys are used to move forward and backward through the menu structure.
- 3 The **ADJUST** key can be used to terminate the adjustment mode while any path selection menu is displayed.

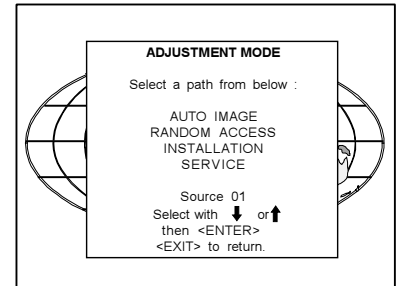

There are 4 possible paths to follow once in the Adjustment Mode. They are :

**Auto Image** - Auto image will center the image on the LCD panel when a file is loaded.

**Installation** - Installation should be selected if a new input module is installed or a new source is connected to an existing input module. Also when the projector is relocated in a new configuration.

**Random Access** - Random Access should be selected to set up a new source.

**Service** - Service should be selected if the user intends to change general settings such as password, language, address, etc. or some service actions as reset lamp run time, panel adjustments, etc. or get set-up information.

Some items in the Adjustment mode are password protected. While selecting such an item, the projector asks to enter your password (Password protection is only available when the password strap on the controller module is ON, call an authorised service center to change the position of the password strap).

#### Password :

The password contains 4 digits.

Enter the digits with the numeric keys.

Example : 2 3 1 9

The first digit position is highlighted. Enter with the numeric keys. The highlighted square jumps to the next position. Continue until all 4 digits are filled in.

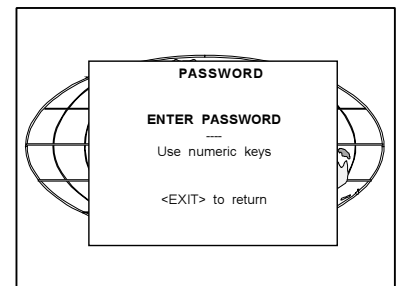

When your password is correct, you gain access to the selected item.

When your password is wrong. The error message "Invalid password" is displayed on the screen. Press **EXIT** to continue and to return to the Service menu.

Factory programmed password : **0 0 0 0**

Once the password is correctly entered, all other password protected items are accessible without re-entering the password.

When re-entering the Adjustment mode, it will be necessary to enter the password again when selecting a password protected item.

Setting up your own password :

See 'Changing password' in the Service mode.

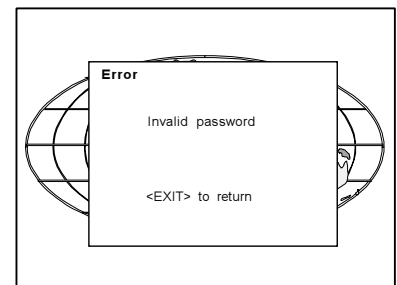

# 8

## AUTO IMAGE ADJUSTMENT

### Auto Image Adjustment

Push the cursor key **↑** or **↓** to highlight 'Auto Image' and press **ENTER**.

With auto image, it is possible to switch the auto image function 'on' or 'off' and to adjust an existing image when the auto image function is off.

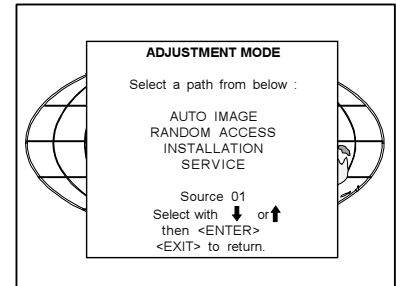

### Adjust

By selecting Adjust the image will be centered on the active area of the LCD surface. The centering will be done by adapting the values for 'pixel start', 'pixel end', 'line start' and 'line end'.

To center the image :

- 1 Push the cursor key **↑** or **↓** to highlight 'Adjust'.
- 2 Press **ENTER** to activate. The image will be centered on the LCD surface. This is the same function as the '?' key on the remote control when in operational mode. The menu is automatically exited. The adjustment values will be saved when switching to another source.

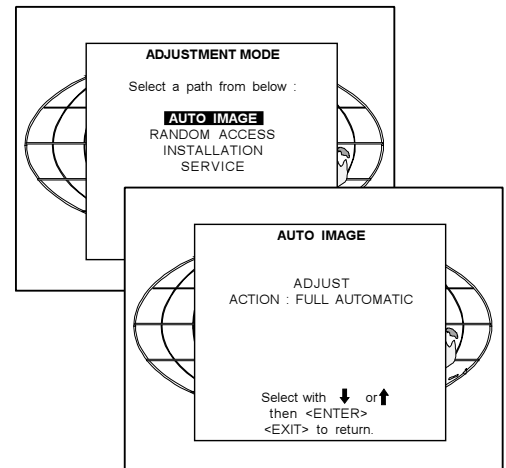

### Action

The action function can be toggled between :

- full automatic
- on new file
- manual

[full automatic] : the best fitting file will be loaded automatically when a source is selected. At the same time the image will be automatically centered on the active surface of the LCD.

The centering of the image will be disabled when :

- 1 The black edges of the image take more than 25% of the complete image.
- 2 The connected source is video, s-video, digital video or HDTV.
- 3 Custom file already exists.

[on new file] : only on a new file, the image will be centered on the active surface of the LCD.

[manual] : the auto image function is switched OFF, no centering, no file load.

To setup the Action function :

- 1 Push the cursor key **↑** or **↓** to highlight 'ACTION'.
- 2 Press **ENTER** to toggle between FULL AUTOMATIC, ON NEW FILE and MANUAL.

The values of automatically adjusted sources will not be saved.

# 9

## RANDOM ACCESS ADJUSTMENT MODE

### Starting up the Random Access Adjustment Mode

Push the cursor key  $\uparrow$  or  $\downarrow$  to highlight 'Random Access' and then press ENTER.

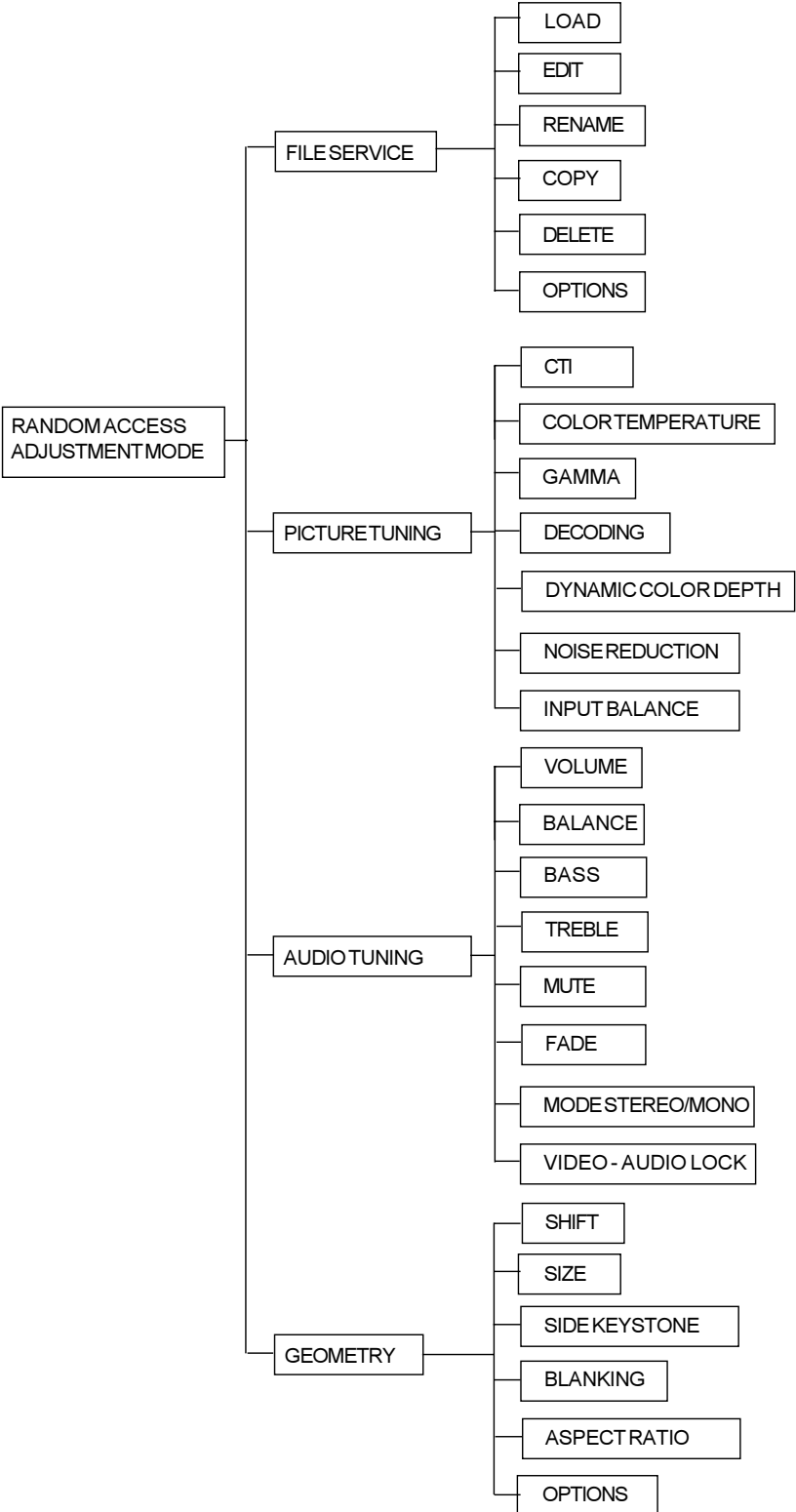
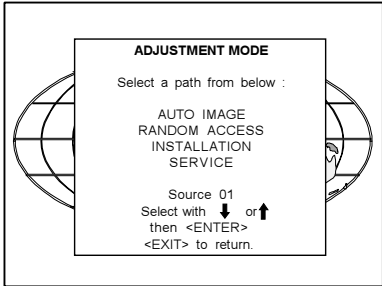

## File Service

Before using a new source, a correct file has to be installed. The projector's memory contains a list of files corresponding to the most used sources. When the new source corresponds with one of these files, the file can be loaded and saved for future use. When there is a little difference, the file can also be loaded and then edited until the source specs are reached.

Note : file loading can be done automatically (see Auto Image, in chapter Auto Image Adjustment).

Files with a ~ in front of the file name are temporary files. These files will be deleted when switching to another source.

File annotation :

xxxxxxxx.xxx x xxxxXxxxxi

i or blank : i = interlaced, blank = not interlaced

xxxxXxxxx : active pixel rating

x : source number

xxx : file extension, first character is C (for custom made files) or S (for standard files).

The second and third character is used for a following number (=file index)

file index for custom files : 00 to 63.

xxxxxxxx : base name, 8 characters.

To enter the File Service, handle as follow :

- 1 Pushing the cursor key  $\uparrow$  or  $\downarrow$  to highlight 'File Service'.
- 2 Press **ENTER** to select.

The File service menu will be displayed.

Note : **EXIT** returns to the Path selection menu.  
**ADJUST** returns to operational mode.

The following file manipulations are possible :

- Load : installation of a file for a new source.
- Edit : editing a loaded file to the source specs.
- Rename : renaming a file.
- Copy : copying a file to a new file.
- Delete : deleting an existing file.
- Options : way of sorting the files & automatic file loading.

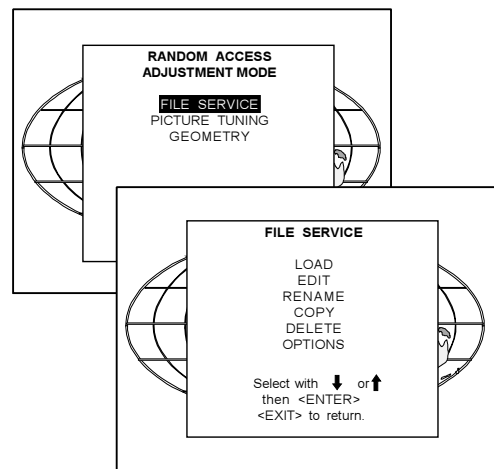

## Load File

- 1 Push the cursor key  $\uparrow$  or  $\downarrow$  to highlight 'Load'.
  - 2 Press **ENTER** to select.
- The Load menu displays the corresponding files depending on the installed filter.

This filter can be "Fit" or "All". To change the filter :

- 1 Push the cursor key  $\rightarrow$  or  $\leftarrow$  highlight 'filter list'.
- 2 Press **ENTER** to toggle the annotation between brackets.

"All" : all files that can be loaded will be displayed.

"Fit" : only the best fitting files will be displayed (with a distinction of  $\pm 2$  lines and line duration distinction of  $\pm 300$  ns, if nothing is found within this small area, the projector continues searching until it finds something.)

To load a file :

- 1 Push the cursor key  $\uparrow$  or  $\downarrow$  to select the best fitting file.
  - 2 Press **ENTER** to select.
- A confirm Load file menu will be displayed with the newly created file and the one on which the new file is based on.
- 3 Press **ENTER** to confirm the new creation or **EXIT** to return to the load file menu.

Note:

When scrolling through the files, the image will be adapted according to the settings of the selected file (on line adaptation).

If the displayed image is not correct after selecting the best fitting file, go to the Edit menu, select the active file and change the File settings.

During a load file, the actual active file is displayed next to the indication 'Active file'.

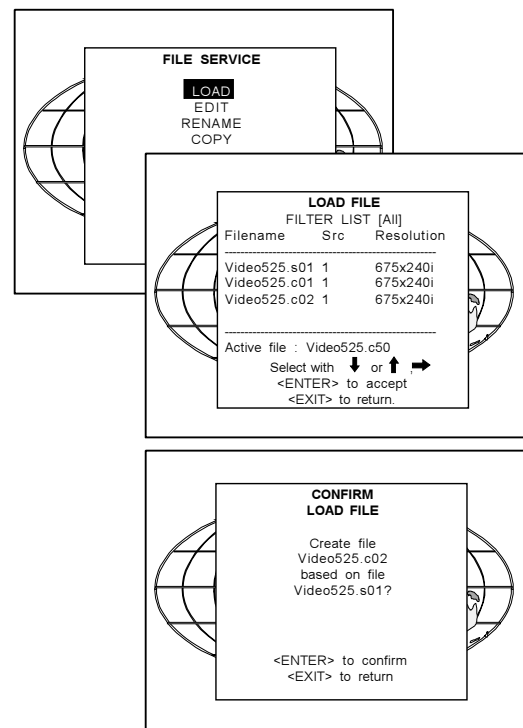

## Edit File

The Edit file menu makes it possible to change the settings of the file according to the real settings of the connected source. Consult the source specification before entering the data.

To start up the EDIT menu:

- 1 Push the cursor key  $\uparrow$  or  $\downarrow$  to highlight 'Edit'.
- 2 Press **ENTER** to select.  
The Edit file adaptation menu will be displayed.
- 3 Select the file which must be edited (mostly the active file).
- 4 Press **ENTER**.

The file name will be displayed in the upper right corner.

The following items can be adjusted :

- Total quantity horizontal pixels
- Active quantity horizontal pixels
- Horizontal start in pixels
- Horizontal period in  $\mu\text{s}$  (is automatically adapted during the installation of a file with LOAD)
- Total vertical lines (is automatically adapted during the installation of a file with LOAD)
- Active vertical lines
- Vertical start in lines
- Interlaced : toggle on/off (is automatically set to its correct position during the installation of a file with LOAD)

All settings can individually be changed.

- 1 Push the cursor key  $\uparrow$  or  $\downarrow$  to select an item.  
The color of the selected item will change and follow one of the three methods to change the value.

a. method 1:

- 1 press **ENTER** to activate the digits
- 2 enter directly with the numeric keys on the RCU or local keypad the new value or

b. method 2:

- 1 Press **ENTER** to activate the digits
- 2 Push the cursor key  $\rightarrow$  or  $\leftarrow$  to select the changing digit.
- 3 Push the cursor key  $\uparrow$  or  $\downarrow$  to scroll to desired digit.
- 4 When finished press **ENTER** to confirm.

c. method 3

- 1 Counting up or down by pushing the cursor key  $\rightarrow$  or  $\leftarrow$ .

*How to find the correct values for the displayed item?*

During the installation of a file with LOAD, the horizontal period, the total number of vertical lines and the interlaced mode are automatically measured and filled in in the menu table. These values will be available when starting up the EDIT procedure of an active file.

**(Caution : Do not adjust these settings on an active file, they are used to identify the input source file.)**

If the value for "Horizontal Total Pixels" is wrong, sampling mistakes (small vertical bars in the projected image) will be seen in the image. Select "Total" and adjust the pixel quantity. Adjust for zero bars (hint: if the number of bars increase, adjust in the other direction).

The "Active Pixels" : determine the width of the window on the screen. This value is normally given in the source specifications. If not, adjust until full image is displayed (no missing pixels).

"Horizontal Start" : number of pixels between the beginning of the input signal and the start of the video information in the signal.

"Horizontal Period" : already filled in with the correct value when active file. (see caution above).

The "Vertical Total Lines" are already filled when an active file is selected to be edited (see caution above).

The "Active Lines" : number of horizontal lines determining the height of the projected image. This value is normally given in the specification of the source. If not, adjust until full image height is displayed (no missing lines)

Vertical start : number of lines between the start of the input signal and start of the image on the screen.

Interlaced [On] or [Off] : this selection is automatically filled when active file has to be edited. If the image is wrong due to mismeasurement, use the ENTER key to toggle between [On] and [Off]. (for interlaced images, 1 frame contains 2 fields).

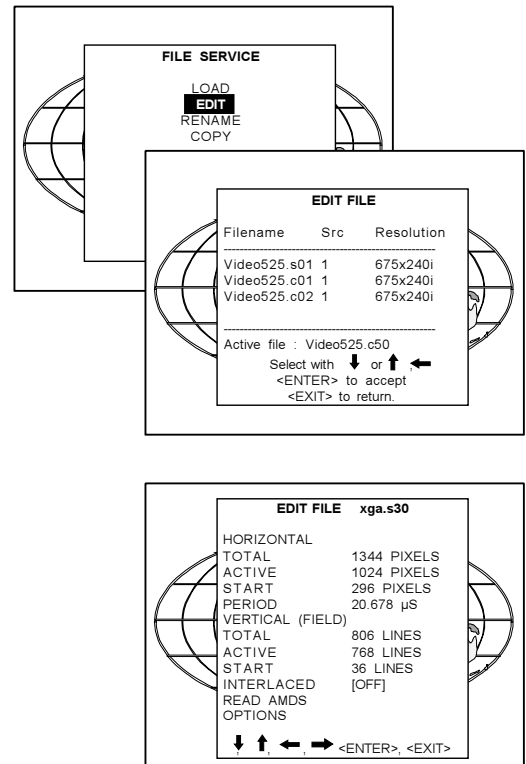

**Read AMDS**

AMDS = automatic mode detection & synchronisation

During the installation of a file with LOAD, the system automatically measured the horizontal period, the total vertical lines and the interlaced mode.

When selecting Read AMDS, the system remeasures the above indicated items.

**Options**

**Source Number** : The source number of a non-active source can be changed to any other source number. This makes it possible to create a file for future source numbers.

**Clamp Position** : Clamping determines the black level of the signal. The clamp pulse can be related to the leading or the trailing edge of the sync pulse. Use the **ENTER** key to toggle between [leading] and [trailing].

**Clamp Delay** : The time between the leading edge of the clamp pulse and the locked edge of the sync pulse. Can be any value between 0 and 255. Change the value by pushing the cursor key **→** or **←**.

**Clamp Width** : The width of the clamp pulse. Can be any value between 0 and 255. Change the value by pushing the cursor key **→** or **←**.

**Field Polarity** : The field polarity function is used for interlaced images. Both rasters of the image could be shifted in a wrong way (double lines are visible in the image). This can be corrected by forcing the field polarity to [neg] or [pos]. Use the **ENTER** key to toggle between [pos] and [neg].

**Field Select** : Default [both]  
The field select is only used for interlaced images. One frame of an interlaced image contains two fields, an even and an odd field. The choice exists to project [both] fields on the screen or only the [even] or [odd] field. This can be useful for 3D projection. Use the **ENTER** key to toggle between [both], [even] and [odd].

**Vertical Refresh [sync/async]** : The way of updating the image information on the LCD panels. Not available for PAL-NTSC-SECAM sources. This option will be displayed in gray.

\* For sources with a vertical frequency up to 60 Hz : the vertical refresh rate is the same as the vertical frequency of the incoming source. This is a necessity to project moving images without 'motion artifacts'. For stationary images with a vertical frequency up to 60 Hz it is still possible to use asynchronous refresh. When loading Pal, Secam, NTSC-files the synchronous mode is default, for all other sources below 60 Hz asynchronous mode is default.

\* For sources with a vertical frequency higher than 60 Hz : the vertical refresh is different than the vertical frequency of the incoming source. Synchronous refresh cannot be used.

**Vertical Sync Polarity** : [leading] or [trailing]  
The vertical refresh can be synchronised with the leading sync edge or trailing sync edge. Default on [leading].  
Toggling to [trailing] is only necessary for special applications where the trailing edge of the sync signal has to be taken as a reference. Use the **ENTER** key to toggle between [leading] or [trailing]

Press **EXIT** to leave the Edit File Option menu.  
A 'Confirm Edit File' menu will be displayed.  
Press **ENTER** to confirm and to save the new settings or **EXIT** to return without saving the new entered settings.

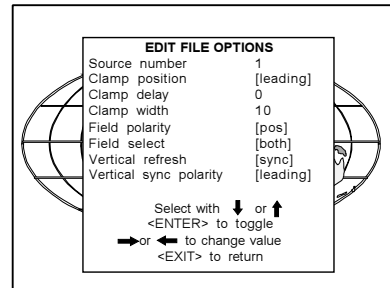

Example for clamp position [trailing]

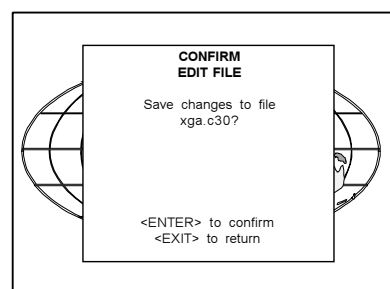
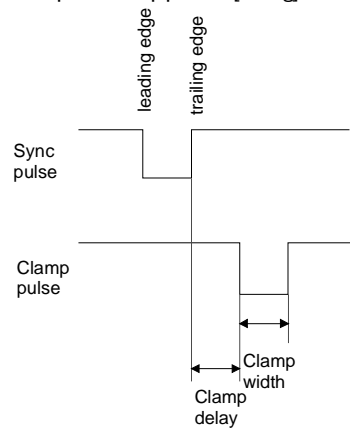

## Rename

To change the name of a selected file:

- 1 Push the cursor key  $\uparrow$  or  $\downarrow$  to highlight 'Rename'.
- 2 Press **ENTER**.  
The Rename selection menu will be displayed.
- 3 Push the cursor key  $\uparrow$  or  $\downarrow$  to select a file name.
- 4 Press **ENTER** to select.

The Rename menu will be displayed with the selected file name already filled in, leave in the 'From file name :' area and in the 'To file name :' area.

The first character is highlighted.

- 1 Push the cursor key  $\leftarrow$  or  $\rightarrow$  to select the desired character.
- 2 Change that character by pushing the cursor key  $\uparrow$  or  $\downarrow$ .  
Numeric characters can be entered directly with numeric keys on the RCU.
- 3 Press **ENTER** to confirm. The renamed file is entered in the list of files.
- 4 Press **EXIT** to return to the Rename menu selection. No changes are made.

## Copy

To copy a selected file into a new file :

- 1 Push the cursor key  $\uparrow$  or  $\downarrow$  to highlight 'Copy'.
- 2 Press **ENTER**.  
The Copy selection menu will be displayed.
- 3 Push the cursor key  $\uparrow$  or  $\downarrow$  to select a file name.
- 4 Press **ENTER** to select.

The Copy menu will be displayed with the selected file name already filled in, in the 'From file name :' area and in the 'To file name :' area.

The first character is highlighted.

- 1 Push the cursor key  $\leftarrow$  or  $\rightarrow$  to select the desired character.
- 2 Change that character by pushing the cursor key  $\uparrow$  or  $\downarrow$ .  
Numeric characters can be entered directly with numeric keys on the RCU.
- 3 Press **ENTER** to confirm. The renamed file is entered in the list of files.
- 4 Press **EXIT** to return to the Copy menu selection. No changes are made.

## Delete

To delete a selected file out of the list of files :

- 1 Push the cursor key  $\uparrow$  or  $\downarrow$  to highlight 'Delete'.
- 2 Press **ENTER**.  
The delete selection menu will be displayed.
- 3 Push the cursor key  $\uparrow$  or  $\downarrow$  to select a file name.
- 4 Press **ENTER** to select.  
If [All] is selected, your password has to be entered before all files will be deleted.

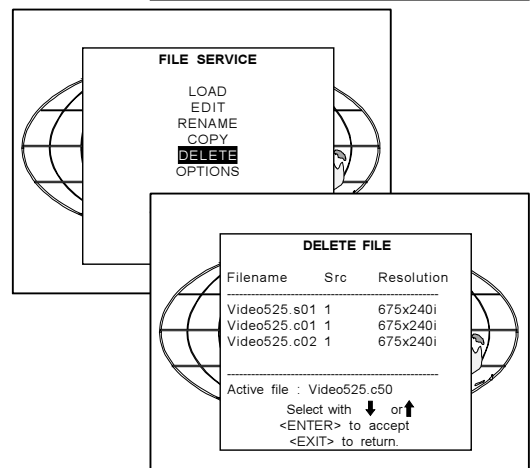
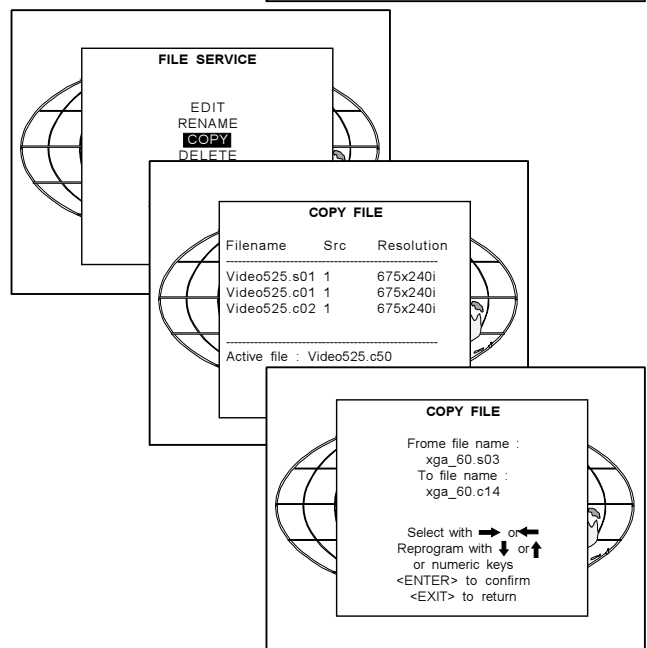
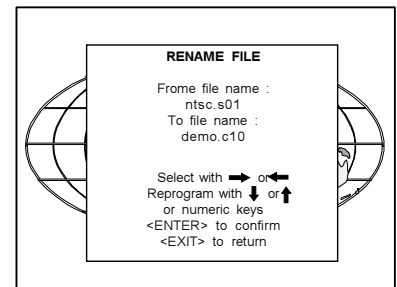
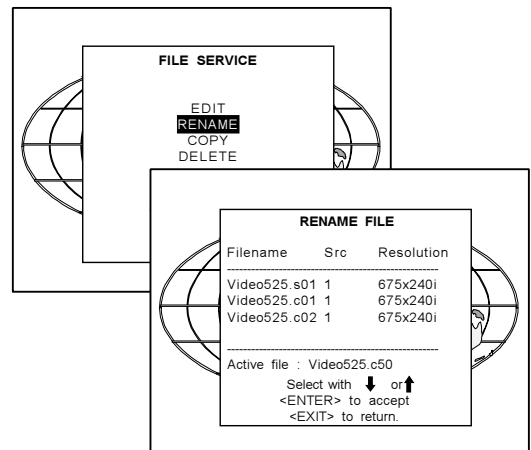



## Random Access Adjustment Mode

A confirmation menu "Delete file 'file name'?" is displayed. When you want to delete the file, press **ENTER**. If you do not want to delete the file, press **EXIT**.

Note : the active file cannot be deleted.

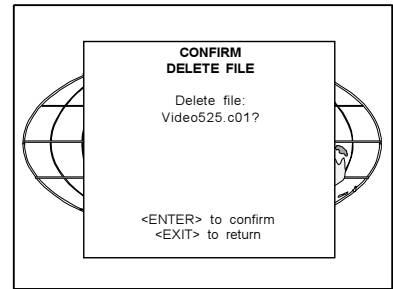

## File Options

- 1 Push the cursor key **↑** or **↓** to highlight 'File Options'.
- 2 Press **ENTER**.  
The option selection menu will be displayed.

*File Sort*

Press **ENTER** to toggle between [name] and [index]

[name] : The files in the file list will be sorted on the file name.

[index] : The files in the file list will be sorted on the file extension.

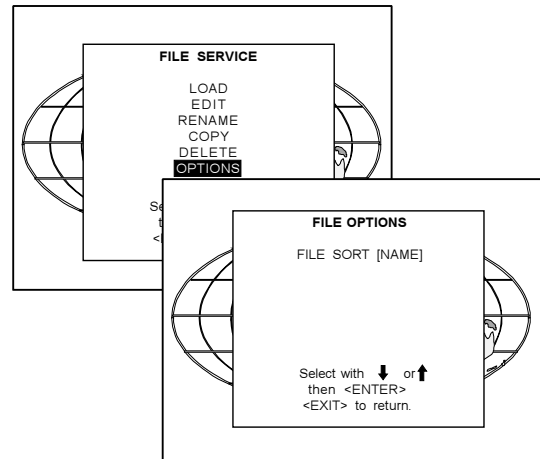

## Picture Tuning

- 1 Push the cursor key **↑** or **↓** to highlight 'Picture Tuning'.
- 2 Press **ENTER** to select.  
The Picture Tuning menu will be displayed.

The next items are available :

- CTI ON/OFF
- color temperature
- gamma
- decoding EBU/IRE
- dynamic color depth
- noise reduction
- input balance

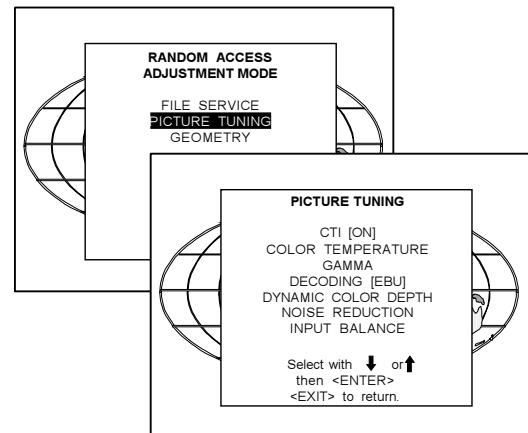

## CTI ON/OFF

CTI : Color Transient Improvement.  
To improve the transition from one color to another.

- 1 Push the cursor key **↑** or **↓** to highlight 'CTI'.
- 2 Press **ENTER** to toggle between ON and OFF.

This function applies to PAL and NTSC video or S-video inputs only.

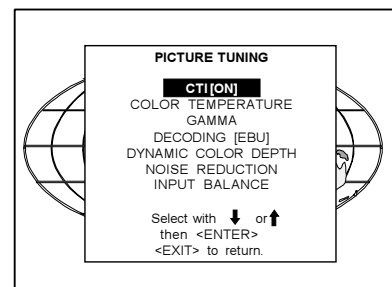

## Color Temperature

- 1 Push the cursor key **↑** or **↓** to highlight 'Color Temperature'.
- 2 Press **ENTER** to select.  
The color temperature selection menu will be displayed.

The next choices are possible :

- Projector white
- Broadcast 3200 K
- Film 5400 K
- Video 6500 K
- Computer 9300 K
- Custom balance.

Push the cursor key up or down to select a fixed color temperature or custom balance.

Projector white will provide maximum projector light output.  
The calibrated 'Broadcast', 'Film', 'Video' and 'Computer' presets will provide optimum color tracking.  
Custom balance allows the user to set his own preferred color temperature.

To adjust Custom Balance, handle as follow :

- 1 Push the cursor key **↑** or **↓** to highlight 'Custom Balance'.
- 2 Press **ENTER** to select.
- 3 Push the cursor key **↑** or **↓** to adjust red and push the cursor key **←** or **→** to adjust blue (range 0 to 2.5) in comparison with the green color (value 1).

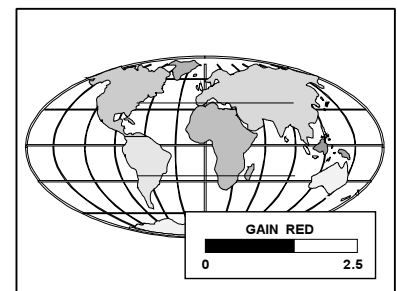
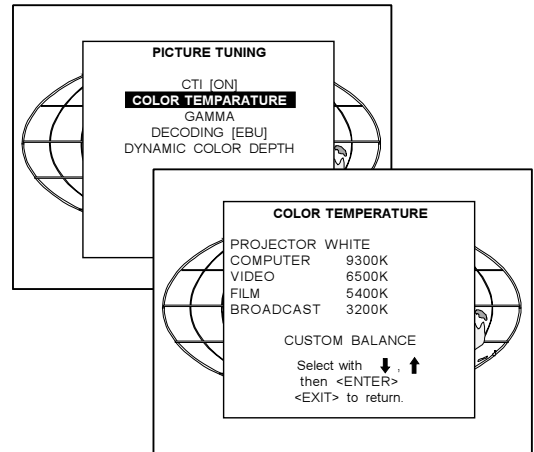

## Gamma

With the gamma correction adjustment, it is possible to accurately set the gamma of the projector image.

To change the gamma value :

- 1 Push the cursor key **↑** or **↓** to highlight 'Gamma'.
- 2 Press **ENTER** to select.
- 3 Change the gamma value by pushing the cursor key **←** or **→** until the desired value is reached.
- 4 Press **EXIT** to return to the Picture Tuning menu.

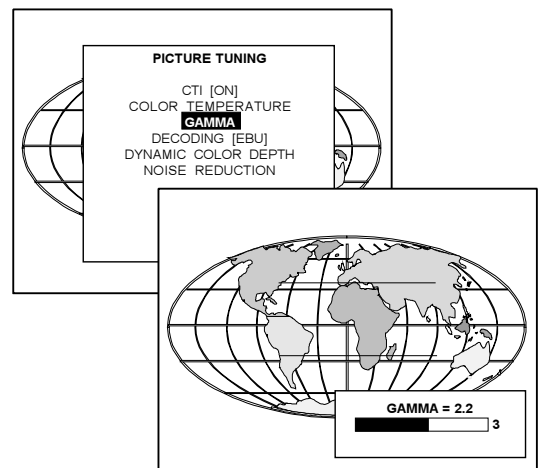

## Decoding EBU/IRE

Only for NTSC signals.

The possibility is offered to decode the NTSC video signals via the default American IRE standard or via the European EBU standard.  
Decoding a NTSC signal using the European EBU standard may result in a greenish tint.

- 1 Push the cursor key **↑** or **↓** to highlight 'Decoding'.
- 2 Press **ENTER** to toggle between EBU or IRE.
- 3 Press **EXIT** to return.

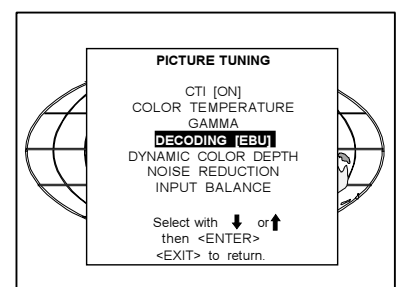

## Dynamic Color Depth

Increases color contrast for all video and data sources.

To change the dynamic color depth value :

- 1 Push the cursor key **↑** or **↓** to highlight 'Dynamic Color Depth'.
- 2 Press **ENTER** to select.
- 3 Change the value by pushing the cursor key **←** or **→** until the desired color contrast is reached.  
Adjustment range : 0 ... 8  
Default : 4
- 4 Press **EXIT** to return to the Picture Tuning menu.

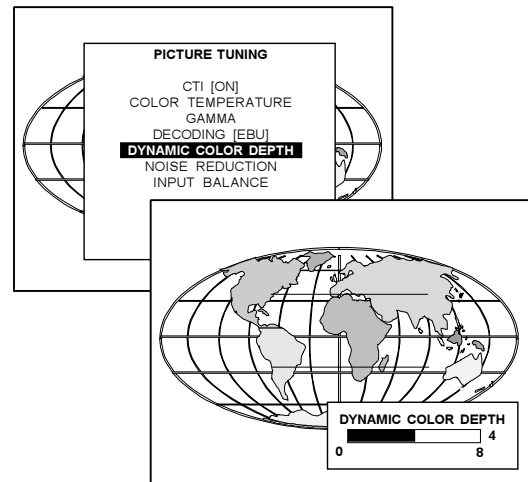

## Noise Reduction

Reduces noise and pixel jitter in all video and data sources.

To change the noise reduction value :

- 1 Push the cursor key **↑** or **↓** to highlight 'Noise Reduction'.
- 2 Press **ENTER** to select.
- 3 Change the value by pushing the cursor key **←** or **→** until the desired noise level is reached.  
Adjustment range : 0 ... 8
- 4 Press **EXIT** to return to the Picture Tuning menu.

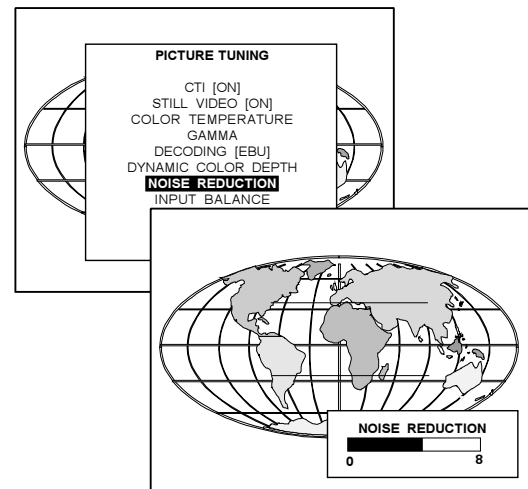

## Input Balance

*Attention : Before starting the Input Balance function, generate a signal with dominant black and white areas.*

The default values are normally loaded when selecting a source. If the image is not as desired, adjust for this source as follow :

Start with the Black Balance :

- 1 Push the cursor key **↑** or **↓** to highlight 'Black Balance'.
- 2 Press **ENTER** to select.
- 3 Adjust the Brightness to a maximum value until there is just no green noise visible in the black areas.
- 4 Adjust with the cursor key **↑** or **↓** or **←** or **→** until there is no red or blue noise visible in the black areas.

Continue with the White Balance :

- 1 Push the cursor key **↑** or **↓** to highlight 'White Balance'.
- 2 Press **ENTER** to select.
- 3 Adjust the Contrast to a maximum value until the white areas are just white (without green noise) and return one step.
- 4 Adjust with the cursor key **↑** or **↓** or **←** or **→** until there is no red or blue noise visible in the white areas.

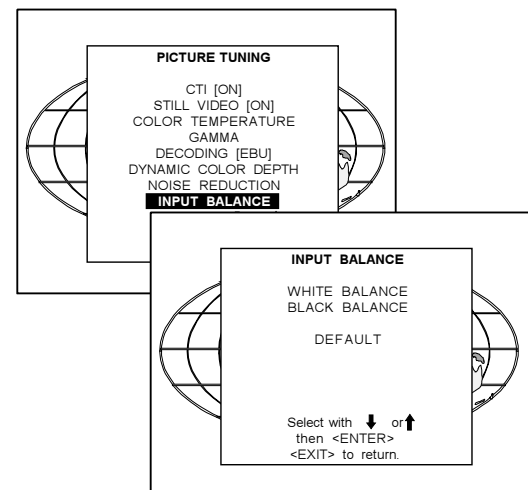

## Audio Tuning

- 1 Push the cursor key **↑** or **↓** to highlight 'Audio Tuning'.
- 2 Press **ENTER** to select.  
The Audio Tuning menu will be displayed.

The following items are available :

- Volume
- Balance
- Bass
- Treble
- Mute
- Fade
- Mode
- Video - Audio lock

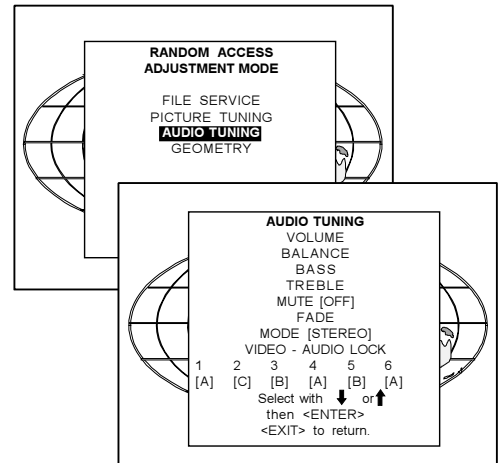

## Volume, Balance, Bass and Treble

When a sound control is selected by highlighting the item with the cursor key, a text box with a bar scale, icon and function name of the control, e.g. 'Volume' appears on the screen (only when text is ON). The length of the bar scale indicates the current memory setting for this source. For more information about the sound controls, see 'Sound controls with direct access' in the Chapter 'Controlling'.

## Mute

To stop the sound reproduction.

- 1 Push the cursor key **↑** or **↓** to highlight 'Mute'.
- 2 Press **ENTER** to toggle between [on] or [off]

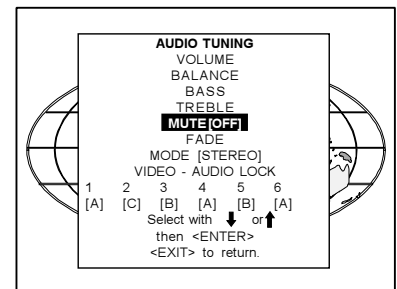

## Fade

Determine where the sound signals will be reproduced. Adjust the fade as follow :

- 1 Push the cursor key **↑** or **↓** to highlight 'Fade'.
- 2 Press **ENTER** to select.
- 3 Adjust the desired fade level.  
The fade can be adjusted between -15 and 15.

Fade on -15 : no sound reproduction on the external loudspeakers, max on the internal loudspeaker with the same volume level as adjusted with the volume control.

Fade on 15 : no sound reproduction on the internal loudspeakers but max on the external loudspeakers with the same volume level as adjusted with the volume control.

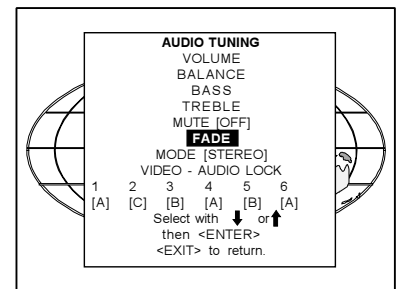

## Mode [stereo]/[mono]

The sound reproduction can be done in mono or stereo. To install the mode :

- 1 Push the cursor key  $\uparrow$  or  $\downarrow$  to highlight 'Mode'.
- 2 Press **ENTER** to toggle between [stereo] or [mono].

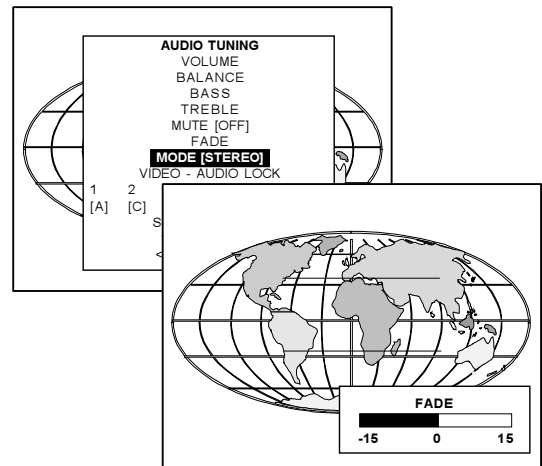

## Video - Audio lock

To lock an input source to an audio input, follow the next steps :

- 1 Push the cursor key  $\uparrow$  or  $\downarrow$  to highlight the first input source.
- 2 Press **ENTER** to toggle the associated audio input between [A], [B] or [C].
- 3 Push the cursor key  $\leftarrow$  or  $\rightarrow$  to highlight another input source.
- 4 Press **ENTER** to toggle between [A], [B] or [C].
- 5 Continue for the other inputs in the same way.

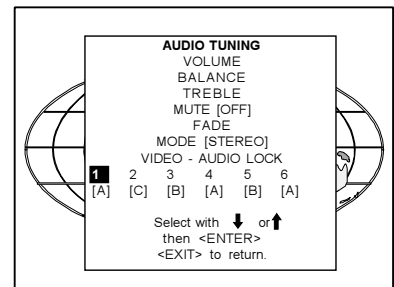

## Geometry

To start up the Geometry functions :

- 1 Push the cursor key  $\uparrow$  or  $\downarrow$  to highlight 'Geometry'.
- 2 Press **ENTER** to select.  
The geometry menu will be displayed.

The following adjustments are possible :

- horizontal and vertical image shift.
- horizontal and vertical image size
- side keystone (only necessary if the projector is mounted at a non standard projection angle).
- blanking
- aspect ratio
- options

The following ways are possible to adjust a geometry function :

- using the cursor key to adjust or
- entering the value with the digit keys. Therefore, press **ENTER** to select the indicated value and enter the desired value with the digit keys. Press **ENTER** to confirm the entered value.

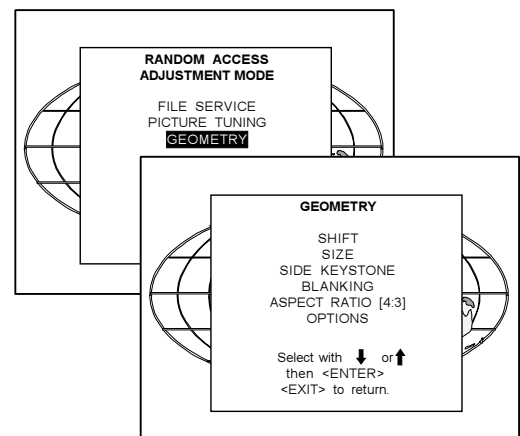

## Shift

The image can be shifted in a horizontal or vertical direction.

To start up the shift action :

- 1 Push the cursor key  $\uparrow$  or  $\downarrow$  to highlight 'Shift'.
- 2 Press **ENTER** to select.
- 3 Push the cursor key  $\uparrow$  or  $\downarrow$  to shift the image in a vertical direction. Push the cursor key  $\leftarrow$  or  $\rightarrow$  to shift the image in a horizontal direction.

The default value for the shift is 0.

Shifting in a vertical direction : when the shift value is positive, the image is shifted upwards, when the value is negative, the image is shifted downwards.

Shifting in a horizontal direction : when the shift value is positive, the image is shifted to the right, when the value is negative, the image is shifted to the left.

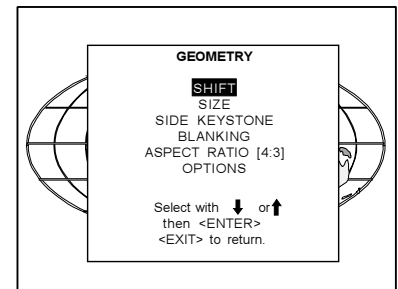

## Size

The size can be adjusted in a vertical or horizontal way.

When adjusting the vertical size,

The upper side of the image is fixed (table and ceiling mounted configurations) and only the lower side can be moved to its exact position.

When adjusting the horizontal size, the left side of the image is fixed and only the right side can be moved to its exact position.

To start up the size adjustment :

- 1 Push the cursor key  $\uparrow$  or  $\downarrow$  to highlight 'Size'.
- 2 Press **ENTER** to select.
- 3 Push the cursor key  $\uparrow$  or  $\downarrow$  to size the image in a vertical direction. Push the cursor key  $\leftarrow$  or  $\rightarrow$  to size the image in a horizontal direction.

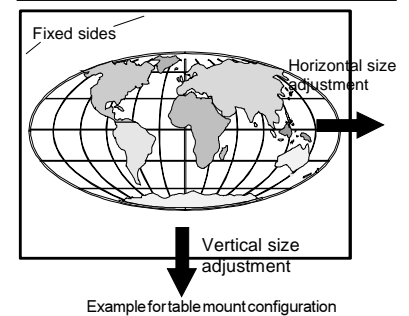
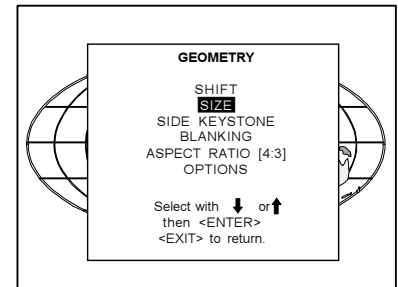

## Side Keystone

The side keystone adjustment is used to align the image if the projector is mounted at a nonstandard projection angle.

To align the keystone :

- 1 Push the cursor key  $\uparrow$  or  $\downarrow$  to highlight 'Side Keystone'.
- 2 Press **ENTER** to select.
- 3 Push the cursor key  $\leftarrow$  or  $\rightarrow$  to adjust the keystone of the image.

When the upper part of the image is wider than the lower part of the image, push the cursor key  $\leftarrow$ . The number indication below the bar scale will be negative.

When the upper part of the image is smaller than the lower part of the image, push the cursor key  $\rightarrow$ . The number indication below the bar scale will be positive.

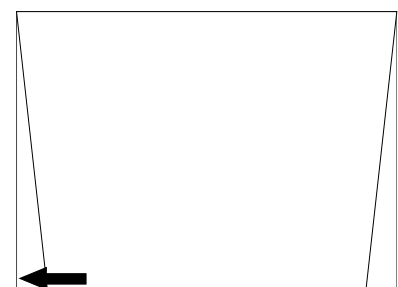
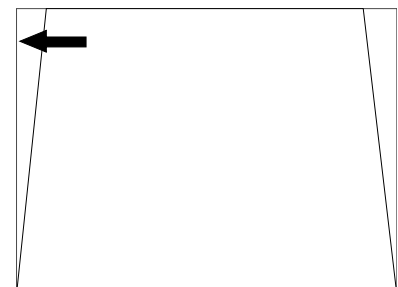
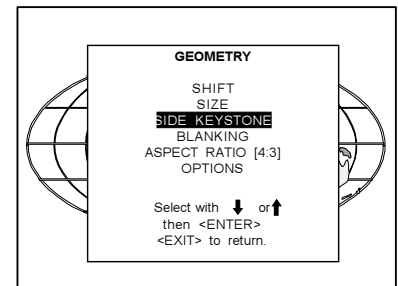

## Blanking

Blanking adjustments affect only the edges of the projected image and are used to frame the projected image on to the screen and to hide or black out unwanted information (or noise). A '0' on the bar scale indicates no blanking.

To adjust the blanking :

- 1 Push the cursor key **↑** or **↓** to highlight 'Blanking'.
- 2 Press **ENTER** to display the blanking menu.

The following blanking corrections are possible :

- top blanking
- bottom blanking
- left blanking
- right blanking

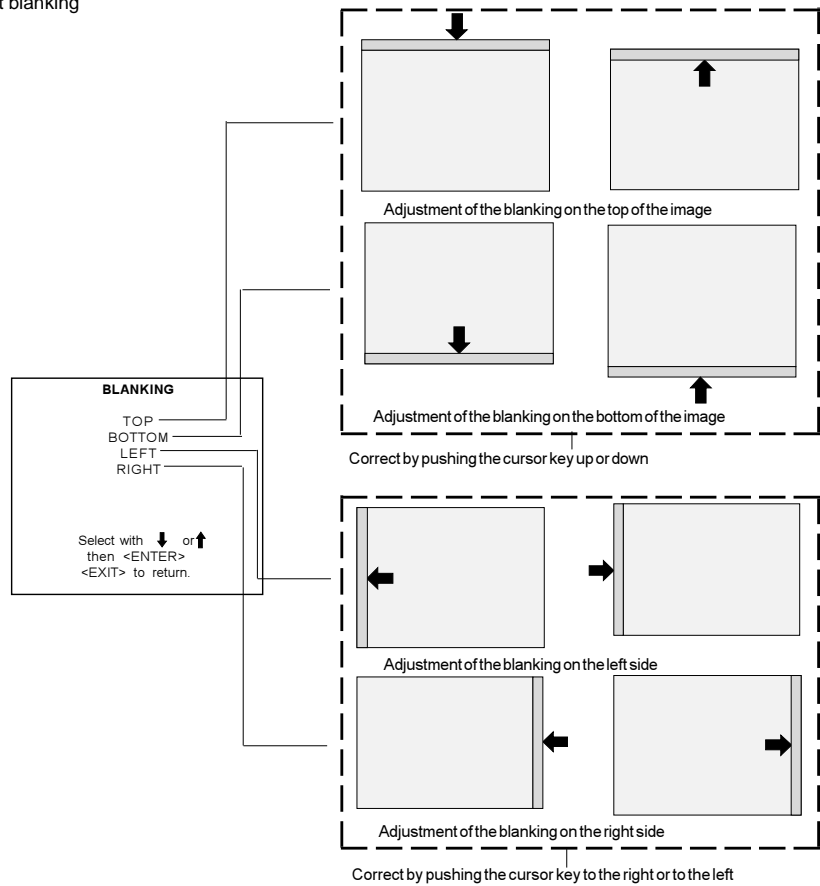
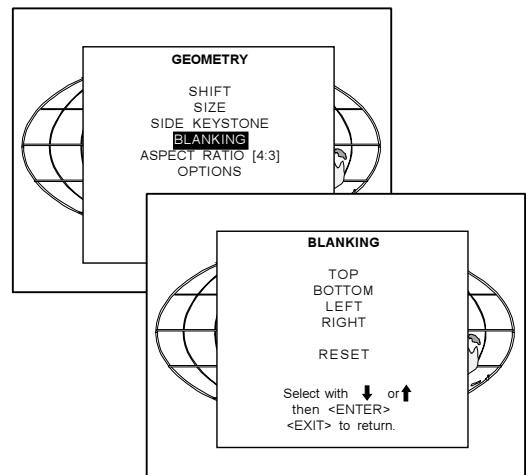
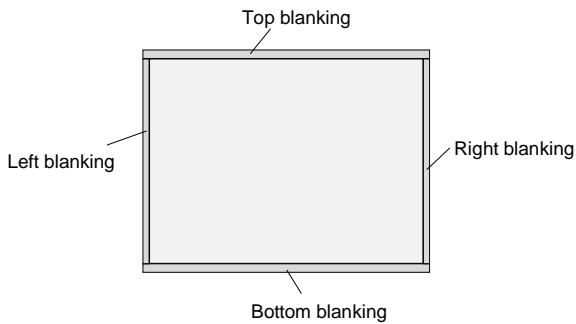

## Aspect Ratio [4:3]/[16:9]

To force the projector in a typical aspect ratio. E.g. projecting a 4:3 image in a 16:9 aspect ratio.

To install the desired aspect ratio :

- 1 Push the cursor key  $\uparrow$  or  $\downarrow$  to highlight 'Aspect Ratio'.
- 2 Press **ENTER** to toggle between [4:3] or [16:9].

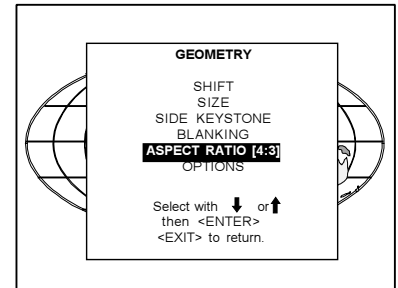

## Options

To change the geometry options :

- 1 Push the cursor key  $\uparrow$  or  $\downarrow$  to highlight 'Options'.
- 2 Press **ENTER** to display the Geometry options menu.

The next question will be asked by the projector :

'Use the same side keystone correction for all files ? [YES] or [NO].

[YES] : the same keystone correction will be used for all installed files.

[NO] : the keystone has to be adjusted file per file.

- 1 Push the **ENTER** key to toggle between [YES] or [NO].
- 2 Press **EXIT** to return to the Geometry menu.

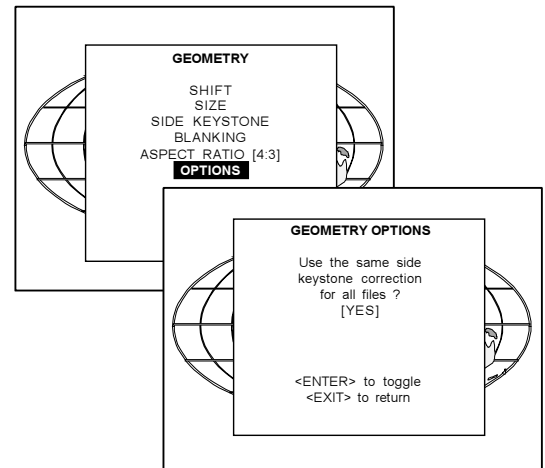



# 10

## INSTALLATION MODE

### Starting up the Installation Mode

Push the cursor key **↑** or **↓** to highlight 'Installation Mode' and then press **ENTER**.

The following item can be selected in the Installation mode :

- Input slots : to set up the input priority.
- 800 Peripheral : to select the type of output module used in the RCVDS05 and the type of communication code, PPM or RC05.
- Configuration : to set up the projector position.
- OSD color : to change the color of the highlighted item.
- Internal Patterns
- No signal : background color when no signal is available.
- Quick Access keys
- Lens : lens adjustments

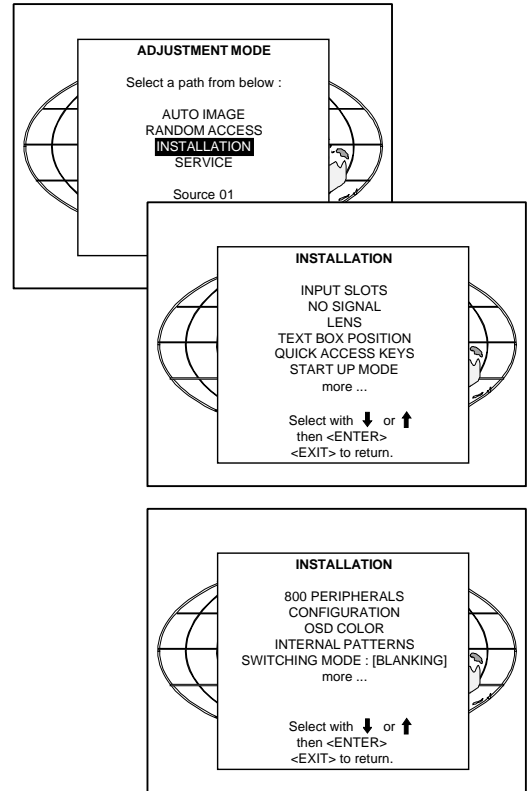

### Input Slots

The input configuration of the variable inputs is shown in the input slots menu. To view or to change the input configuration :

- 1 Push the cursor key **↑** or **↓** to highlight 'Input Slots'.
- 2 Press **ENTER** to select.  
The internal system will scan the input slots and displays the result in the Input slots menu.

The black indicated inputs are selectable and changeable.  
The gray indicated inputs are fix inputs and are not changeable.

The indication in front of the digit means :  
x : valid signal connected to the input.  
- : no valid signal connected to the input.

The indication in the source description can be :

Source	indication
Video or S-Video	Video S-Video
RGB analog	RGB-CV : separate sync is composite video signal on H/C input RGB-HS&VS : separate sync is horizontal and vertical sync RGB-CS : separate sync is composite sync RGB-SOG : sync on green
Component video	Component Video

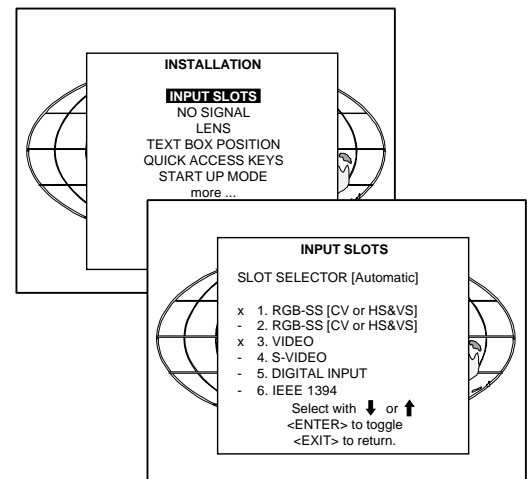

If a RCVDS (switched on) or VS05 is connected to the projector, it will be also indicated on the menu by adding *+800 peripheral*. If no 800 peripheral indication is made on the menu, there are still two possibilities :

- no RCVDS or VS05 connected or
- RCVDS is switched off.

When a 800 peripheral is connected to the projector, the input slots are not accessible with the cursor key to toggle their function.

### No Signal

If there is no signal connect to the projector, the background color can be black or blue and the projector can shutdown after a certain time.

To change the background color handle as follow :

- 1 Push the cursor key **↑** or **↓** to highlight 'No signal'.
- 2 Press **ENTER** to select.  
The 'No Signal' menu will be displayed.
- 3 Push the cursor key **↑** or **↓** to highlight 'Color'.
- 4 Press **ENTER** to toggle between [blue] or [black].

To change the shutdown setting, handle as follow :

- 1 Push the cursor key **↑** or **↓** to highlight 'No signal'.
- 2 Press **ENTER** to select.  
The 'No Signal' menu will be displayed.
- 3 Push the cursor key **↑** or **↓** to highlight 'Shutdown'.
- 4 Press **ENTER** to toggle between [On] or [Off].

The shutdown time can be set between 5 min and 60 min.

To set up the shutdown time, handle as follow :

- 1 Push the cursor key **↑** or **↓** to highlight 'No signal'.
- 2 Press **ENTER** to select.
- 3 Push the cursor key **↑** or **↓** to highlight 'Shutdown time'.
- 4 Push the cursor key **↑** or **↓** to change the digits or  
Enter the digits directly with the digits keys on the RCU.

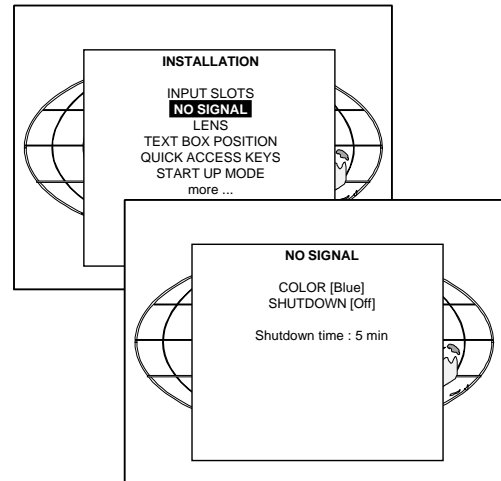

### Lens Adjustments

All lens adjustments are motorized and can be adjusted with the RCU.

To adjust all lens functions such as zoom, focus and shift, handle as follow :

- 1 Push the cursor key **↑** or **↓** to highlight 'Lens'.
- 2 Press **ENTER** to select.  
The Adjustment pattern will be displayed.  
With the **TEXT** key it is possible to toggle between the internal adjustment pattern or the connected source.

The following items can be adjusted:

- Zoom/Focus
- Shift

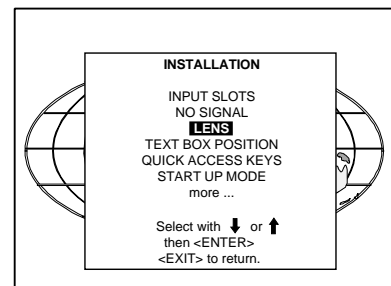

### Zoom/Focus/Shift

The Zoom/Focus function is only applied when a motorised zoom lens is mounted.

To focus or zoom the image :

- 1 Push the cursor key **↑** or **↓** to zoom and **←** or **→** to focus the image.
- 2 When finished, press **EXIT** to return to the installation menu or press **ENTER** to go to the shift function.

To shift the image :

- 1 Press **ENTER** to switch to the shift menu
- 2 Push the cursor key **↑** or **↓** to shift the image up or down and **←** or **→** to shift the image left or right.
- 3 When finished, press **EXIT** to return to the shift menu or press **ENTER** to go to the zoom/focus function.

The lens can be shifted in a range of :

- vertical direction : - 2 mm to + 20 mm
- horizontal direction : - 5 mm to + 5 mm

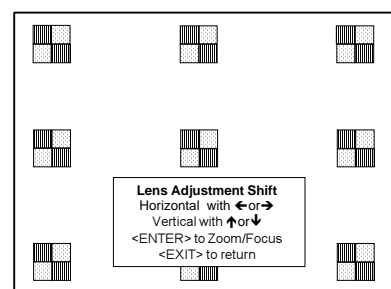
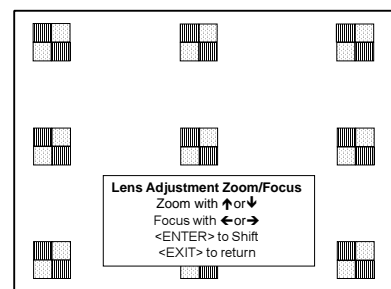

## Text Box Position

With the align function, the text box position can be changed from bottom right to automatic or center.

- 1 Push the cursor key  $\uparrow$  or  $\downarrow$  to highlight 'Text Box Position'.
- 2 Press **ENTER** to select. The 'Text Box Position' menu will be displayed.
- 3 Align will be selected. Press **ENTER** to toggle between [Bottom Right], [Automatic] or [Center].

[Bottom Right] : text box will always be displayed in the bottom right corner.

[Automatic] : the text box position depends on the aspect ratio.

[Center] : the text box position will always be in the middle of the image.

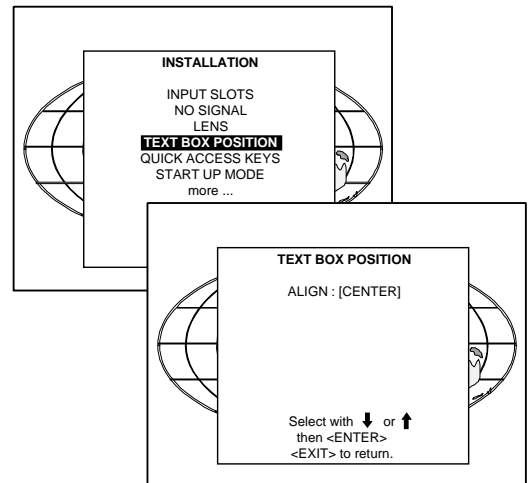

## Quick Access Keys

The function keys on top of the RCU can be associated with an adjustment item in one of the adjustment menus.

Each item which is not password protected or does not have a key on the RCU can be associated to a function key.

The menu Quick Access keys gives an overview of the actual programmed functions.

To get an overview, handle as follow :

- 1 Push the cursor key  $\uparrow$  or  $\downarrow$  to highlight 'Quick Access Keys'.
- 2 Press **ENTER** to select. The Quick Access Keys menu will be displayed.

The following functions are factory preprogrammed :

- F1 : dynamic color depth
- F2 : noise reduction
- F3 : configuration
- F4 : Lens adjust zoom/focus
- F5 : Lens adjust shift

How to program the quick access keys (function keys) :

- 1 Scroll through the menus until the desired menu is active
- 2 Push the desired function key for 3 seconds. The message 'Quick access to this menu with Fx', where x is the digit of the selected function key. If the selected menu is not a valid menu for the quick access keys the next message will be displayed : "Quick access to this menu impossible".

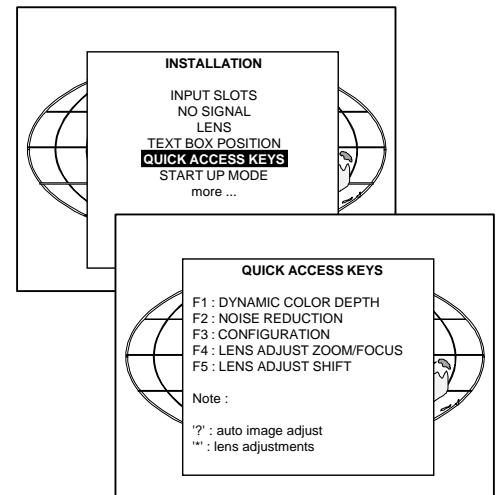

## Start Up Mode

During the start up, the projector can show first the identification screen or the projector starts with a blank screen.

To change the start up mode, handle as follow :

- 1 Push the cursor key  $\uparrow$  or  $\downarrow$  to highlight 'Start Up Mode'.
- 2 Press **ENTER** to select. The start up mode menu will be displayed.
- 3 Select 'Identification' with the cursor keys and press **ENTER** to toggle between [ON] and [OFF]. Identification [ON] : projector identification will be displayed during start up. Identification [OFF] : projector identification will not be displayed during start up.

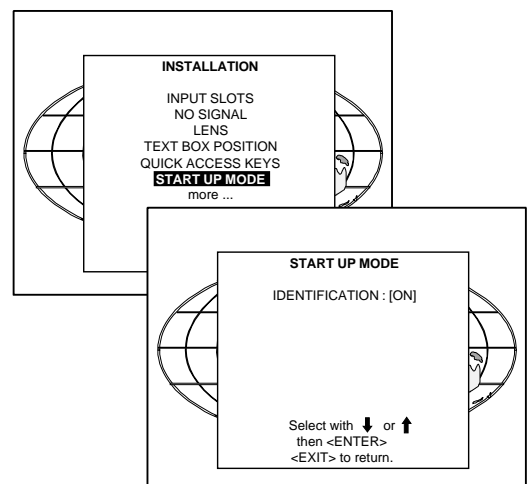

## 800 Peripheral

### Output module selection.

When a RCVDS05 is connected to the projector, the type of output module of this RCVDS05 has to be defined in the 800 peripheral menu.

The type of output module can be :

- standard output module or
- 5 cable output module.

To define the output module :

- 1 Push the cursor key **↑** or **↓** to highlight '800 Peripheral'.
- 2 Press **ENTER** to select.
- 3 Push the cursor key **↑** or **↓** to highlight 'Output module'.
- 4 Press **ENTER** to toggle between 'Standard' or '5-cable'.

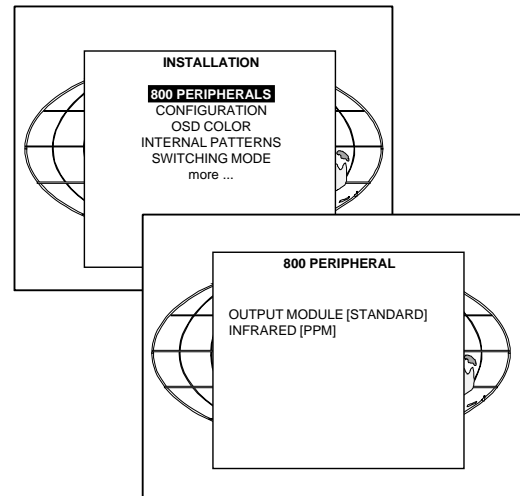

### Infrared Communication.

When a peripheral is connected to the 'Comm Port', the communication can be in PPM or RC5.

The type of communication can be set to :

- PPM
- RC5

To define the communication :

- 1 Push the cursor key **↑** or **↓** to highlight 'Infrared'.
- 2 Press **ENTER** to toggle between [PPM] or [RC5].

## Configuration

The configuration of the projector can be set up as follow :

- 1 Push the cursor key **↑** or **↓** to highlight 'Configuration'.
- 2 Press **ENTER** to select.  
The Configuration menu will be displayed.  
For more information, see Projector configuration in chapter 4 : 'Installation Set Up'.

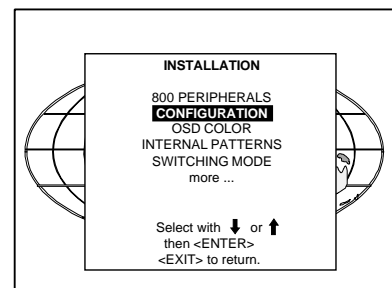

## OSD color (On-Screen Display)

The highlighted items on the menus can be displayed in red, green or yellow.

To change this color setting:

- 1 Push the cursor key **↑** or **↓** to highlight 'OSD color'.
- 2 Press **ENTER** to select.  
The OSD color menu will be displayed.
- 3 Push the cursor key **↑** or **↓** to highlight a color.
- 4 Press **ENTER** to select.

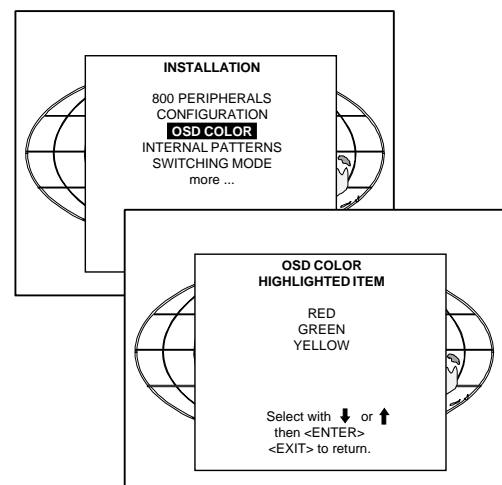

## Internal Patterns

The projector is equipped with different internal patterns which can be used for measurement purposes.

To select an internal pattern, handle as follow :

- 1 Push the cursor key **↑** or **↓** to highlight 'Internal Patterns'.
- 2 Press **ENTER** to select.  
The internal pattern menu will be displayed.
- 3 Push the cursor key **↑** or **↓** to highlight the Internal Patterns.
- 4 Press **ENTER** to display the select internal pattern.

The following patterns are available :

- Outline
- Hatch
- Color Bars
- Multiburst
- Checker Board
- Page Characters
- Alpha-numeric characters
- Character Sets

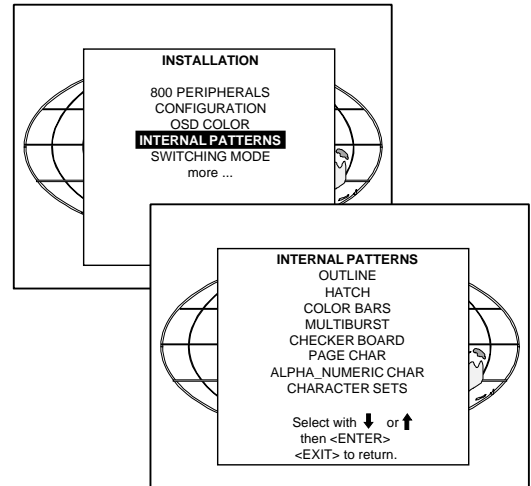

## Switching Mode

When switching from one source to another, the time between the switch off of the first source and the upcoming new source can be filled up with a blank image or with a freeze of the last projected image.

To install the switching mode, follow the next procedure :

- 1 Push the cursor key **↑** or **↓** to highlight 'Switching mode'.
- 2 Press **ENTER** to select.  
The switching mode menu will be displayed.
- 3 Select 'Switching' and press **ENTER** to toggle between [blanking] or [freeze].

[blanking] : by switching from one source to another the image will be blanked out and the installed color in the item 'No Signal' will be displayed.

[freeze] : by switching from one source to another the last projected image will be frozen until the new source is displayed.

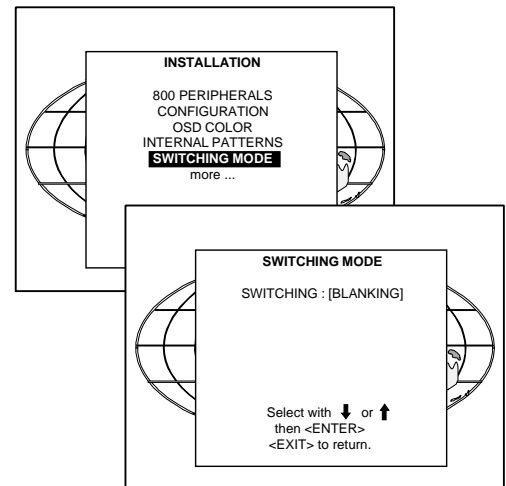

# 11

## SERVICE MODE

### Starting up the Service Mode

Push the cursor key **↑** or **↓** to highlight 'Service' and then press **ENTER**.

Some items in the Service mode are password protected (when the password function is active). Enter the password to continue. All other password protected items are now available if you stay in the adjustment mode.

The service menu is built-up in two parts which are connected together with the 'more' item.

If the desired item is not in the list of the displayed menu, select 'more' with the cursor key and push **ENTER** to display the other items in the service menu.

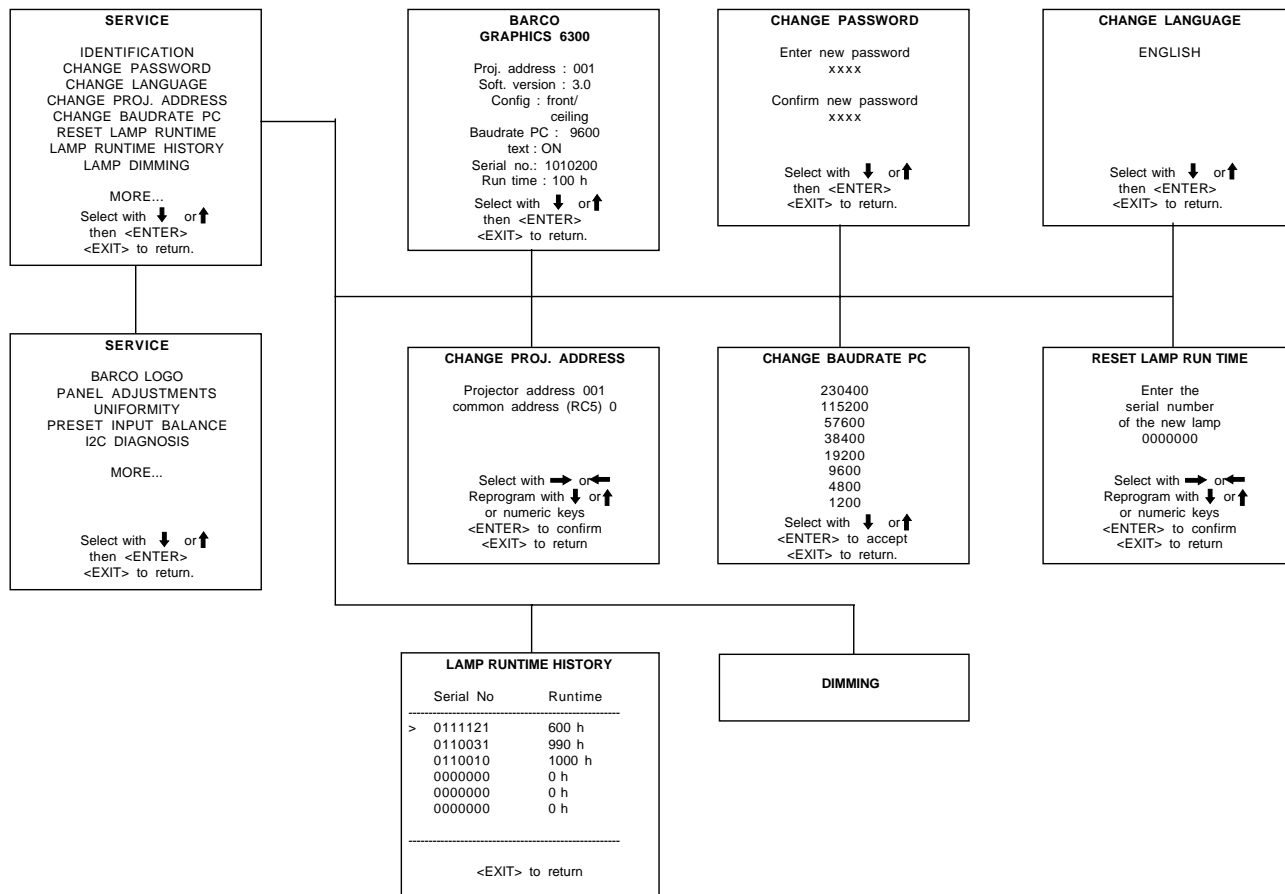
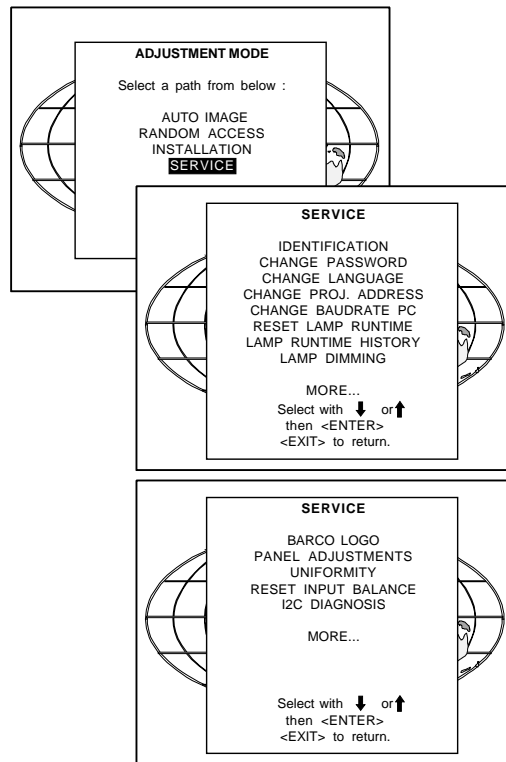

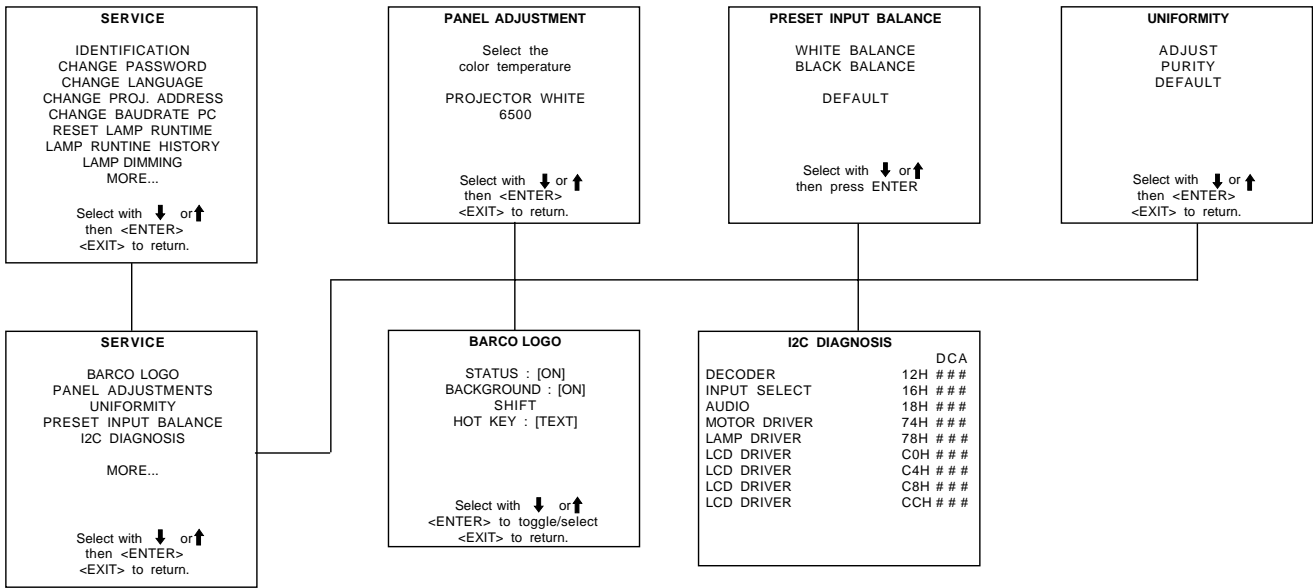

**Identification**

To display the Identification screen:

- 1 Push the cursor key **↑** or **↓** to highlight 'Identification'.
- 2 Press **ENTER** to display the *Identification* screen.

The Identification screen gives an overview of :

- type of projector
- projector address
- software version
- installation configuration
- baud rate
- text ON
- projector serial number
- projector run time

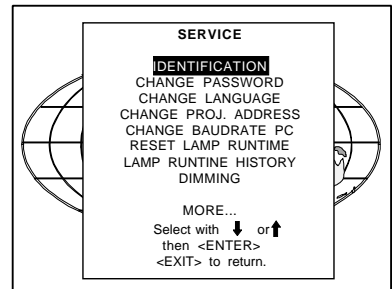

- *type of projector* : BARCOGRAPHICS 6300

- *software version*

- *Proj. Address* : to change the address of the projector, see Change Projector Address in this chapter.

- *Installation* : possible installations :

- \* Front/Ceiling
- \* Front/Table
- \* Rear/Ceiling
- \* Rear/Table

To change the installation configuration follow the instructions in chapter Installation Set Up.

- *Baud rate* : transfer speed for communication with an IBM PC (or compatible) or MAC. The baud rate of the projector must be the same as the baud rate of the connected computer. When there is a difference, consult 'Change Baudrate PC' in this chapter.

- *Projector Run Time* : gives the total run time since the first start up. All projectors leave the factory with a run time of approximately 24 hours.

- *Projector Serial number* : indicates the fabrication number of the projector. This number can be useful when calling for technical assistance.

## Change Password

This item is password protected when the password strap is installed.

### How to enable or disable the password function ?

The password function is enabled when the password strap on the controller module is installed. Consult an authorised Barco service technician to change the strap position.

### How to change the password ?

- 1 Push the cursor key  $\uparrow$  or  $\downarrow$  to highlight 'Change password'.
- 2 Press **ENTER** to display the *Change Password* menu.  
4 '\_' characters are displayed. A new password can be entered with the digit keys of the RCU or local keypad. Everytime a digit is entered, a 'X' appears on the screen. The confirm new password is still grayed out.
- 3 Press **ENTER**, the confirm new password item becomes active.  
Press **EXIT** if no changes have to be made.
- 4 4 'x' characters are displayed in the confirm new password area. Key in your password again with the digit keys of the RCU or local keypad.
- 5 Press **ENTER**.  
If the confirm new password entry is the same as the entered new password, the password is changed.

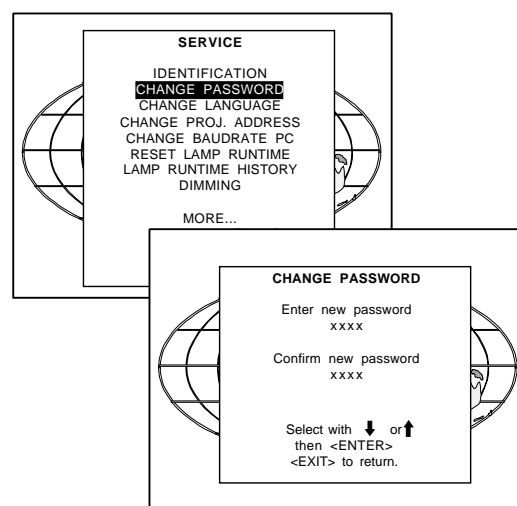

## Change Language

To change the language of the control software:

- 1 Push the cursor key  $\uparrow$  or  $\downarrow$  to highlight 'Change Language'.
- 2 Press **ENTER** to display the *Change Language* menu.
- 3 Push the cursor key  $\uparrow$  or  $\downarrow$  to highlight the desired language.
- 4 Press **ENTER** to change the language.  
Available languages : English

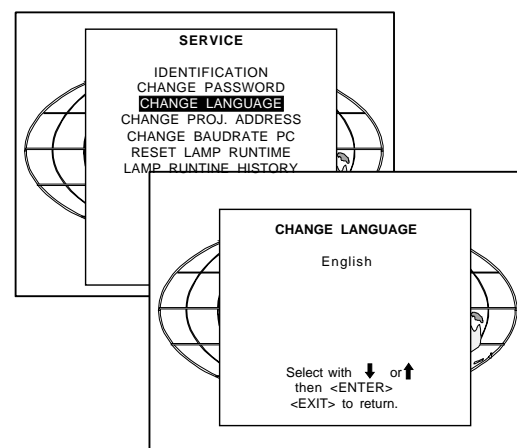

## Change Projector Address

### Projector Address

Every projector requires an individual address between 0 and 255. This address can be software installed.

To change that address:

- 1 Push the cursor key  $\uparrow$  or  $\downarrow$  to highlight 'Change Projector Address'.
- 2 Press **ENTER** to display the *Change Projector Address* menu. The actual address will be filled in.
- 3 Push the cursor key  $\uparrow$  or  $\downarrow$  to highlight 'Projector Address'. The actual address will be filled in. The first digit is highlighted. Enter the new projector address with :  
- the digit keys on the RCU or the local keypad or  
- push the cursor key  $\leftarrow$  or  $\rightarrow$  to select a digit and change the value by pushing the cursor key  $\uparrow$  or  $\downarrow$  until the new value is reached. Continue with the other digits on the same way.

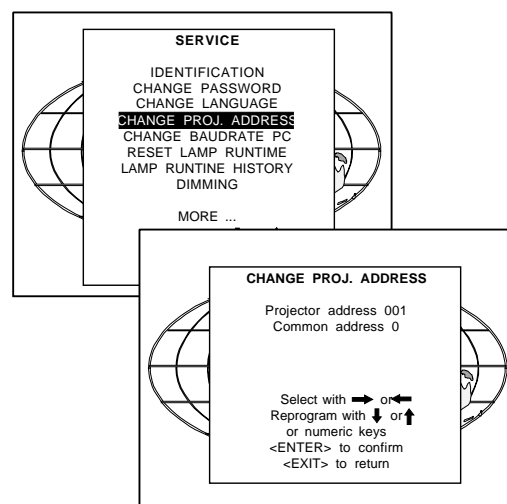



### Common Address

Every projector listens to a common address. This common address can be set to '0' or '1'. When the RCU is programmed with that common address, every projector with that same common address will follow up the commands given by that RCU.

To change the common address :

- 1 Push the cursor key **↑** or **↓** to highlight 'Common Address'.
- 2 Press **ENTER** to toggle between '0' and '1'.

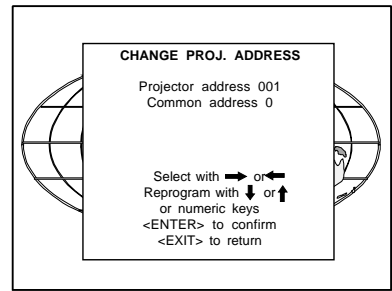

### Change Baudrate PC

The communication speed between projector and computer, e.g. PC or MAC, has 8 possible speeds. The baud rate speed can be software set. Handle as follow:

- 1 Push the cursor key **↑** or **↓** to highlight 'Change Baudrate PC'.
- 2 Press **ENTER** to display the *Change Baudrate PC* menu. The actual baudrate will be highlighted. The following baud rates are available :  
230400/115200/57600/38400/19200/9600/4800/1200
- 3 Push the cursor key **↑** or **↓** to highlight the desired baudrate.
- 4 Press **ENTER** to select.

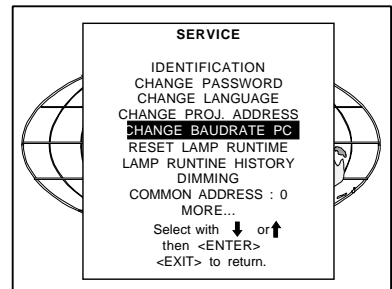

### Reset Lamp Runtime

Reset lamp run time is only allowed when a new lamp is installed.

When Reset Lamp Run Time is selected in the Service Mode selection menu, the following warning will be displayed :

Risk of electrical shock. Reset lamp run time is reserved to qualified service personnel.

If you are not qualified, press **EXIT** to cancel the reset operation.

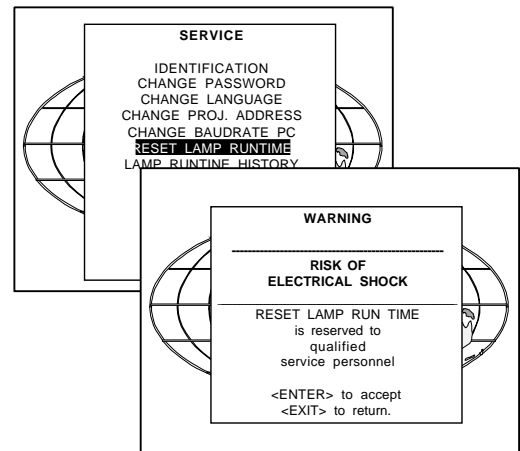

### Lamp Run Time History

To get an overview of the different lamp run times:

- 1 Push the cursor key **↑** or **↓** to highlight 'Lamp Run Time History'.
- 2 Press **ENTER** to display the *Lamp Run Time* overview. A listing with the lamp serial number and the corresponding run time will be displayed. The actual installed lamp will be marked.
- 3 Press **EXIT** to return to the service mode selection menu.

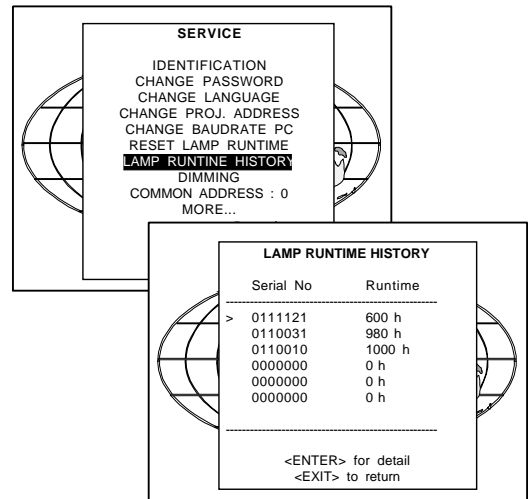

## Dimming

The lamp can be dimmed. Therefore:

- 1 Push the cursor key **↑** or **↓** to highlight 'Lamp Dimming'.
- 2 Press **ENTER** to select.
- 3 Push the cursor key **←** or **→** to dim the lamp.

Remark : The projector starts always with full lamp power.

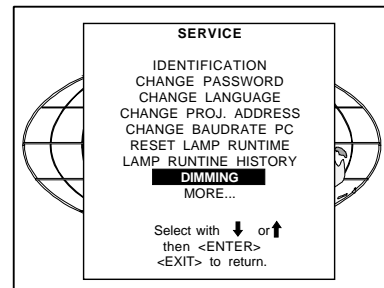

## BARCO logo

The BARCO logo can be added to the image, in overlay or on a background, on any place on the screen.

To add the BARCO logo or to change a setting in the BARCO logo menu:

- 1 Push the cursor key **↑** or **↓** to highlight 'BARCO logo'.
- 2 Press **ENTER** to display the *BARCO logo* menu. The actual settings will be displayed. Within this menu, three toggle settings and a shift control are available.

### STATUS[ON/OFF]

- ON : BARCO logo will be displayed on the screen.
- OFF : No BARCO logo displayed on the screen.

### BACKGROUND[ON/OFF]

- ON : BARCO logo will be displayed on a black background.
- OFF : BARCO logo will be displayed without any background.

### SHIFT

By pushing the cursor key **↑**, **↓**, **←** or **→**, the BARCO logo can be positioned anywhere on the screen.

### HOTKEY[TEXT/OFF]

- OFF : no key on the RCU is used to display the BARCO logo.
- TEXT : the TEXT key on the RCU is used to display or to remove the BARCO logo with one single push on this key (only in operational mode).

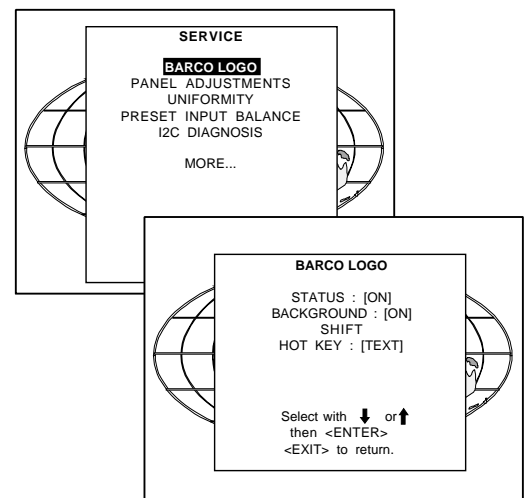

## Panel Adjustments

**Changing these settings may seriously affect the performance of the projector.**

All panel adjustments are factory adjusted. If not really necessary, do not touch any of these adjustments. They are useful when a new panel is installed.

When Panel Adjustments is selected in the Service Mode selection menu, the following warning will be displayed :

Panel Adjustments is reserved to qualified service personnel. If you are not qualified, press EXIT to cancel the panel adjustments.

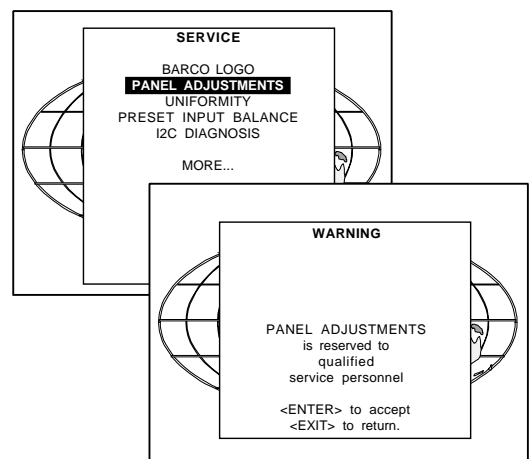

## Uniformity

**Changing these settings may seriously affect the performance of the projector.**

When Uniformity is selected in the Service Mode selection menu, the following warning will be displayed :

Uniformity is reserved to qualified service personnel.  
If you are not qualified, press EXIT to cancel the uniformity.

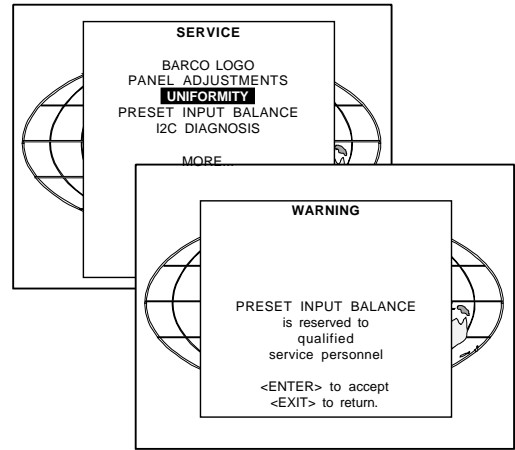

## Preset Input Balance

**Changing these settings may seriously affect the performance of the projector.**

When Preset Input Balance is selected in the Service Mode selection menu, the following warning will be displayed :

Preset Input Balance is reserved to qualified service personnel.  
If you are not qualified, press EXIT to cancel the preset input balance.

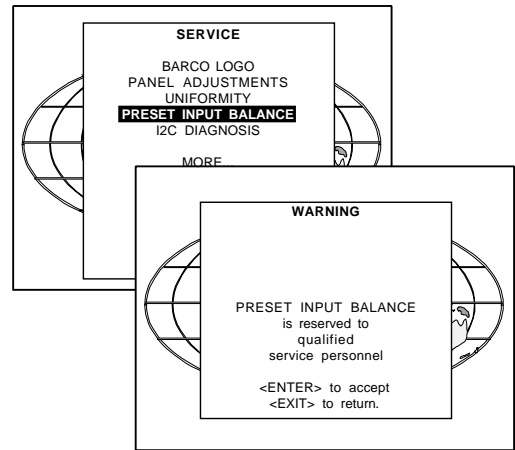

## I2C diagnosis.

Gives an overview of the correct working of the I<sup>2</sup>C controlled IC's. Highlight I2C diagnosis by pushing the cursor key up or down and press ENTER to display the overview.

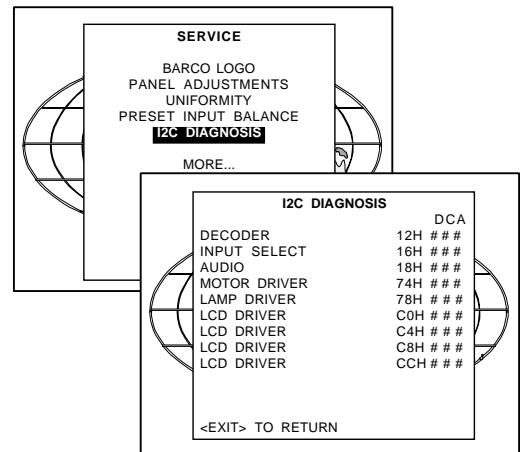

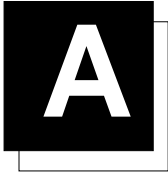

# STANDARD SOURCE SET UP FILES

NAME	RESOLUTION	FVERT Hz	FHOR kHz	FPIX MHz	PTOT	PACT	LTOT	LACT
8514_A	1024 X 384I	43,479	35,522	44,900	1264	1024	409	384
CGA	640 X 200	59,924	15,700	14,318	912	640	262	200
COMPUSC4	1024 X 480I	29,945	30,694	39,779	1296	1024	512	480
ED	735 X 480	59,943	31,470	28,638	910	735	525	480
EGA	640 X 350	59,702	21,851	16,257	744	640	366	350
EWS_50	1280 X 1024	50,000	52,350	87,948	1680	1280	1047	1024
EWS_60	1280 X 1024	60,000	63,900	107,352	1680	1280	1065	1024
EWS_60V	1280 X 1024	60,282	63,657	110,000	1728	1280	1056	1024
EWS_72	1280 X 1024	72,000	76,968	130,076	1690	1280	1069	1024
EWS_75	1280 X 1024	75,025	79,976	135,000	1688	1280	1066	1024
FMR	640 X 400I	42,323	36,440	28,570	784	640	431	400
FMTO_2	640 X 400	55,370	24,370	21,056	864	640	440	400
HDMAC	1252 X 570I	25,020	31,250	39,125	1252	1024	625	570
INTER_GR	1184 X 886	67,170	61,796	92,941	1504	1184	920	886
MAC_2	640 X 480	66,667	35,000	30,240	864	640	525	480
MAC_3	512 X 384	60,147	24,480	15,667	640	512	407	384
MAC_4	560 X 384	60,147	24,480	17,234	704	560	407	384
MAC_5	512 X 342	60,158	22,259	15,670	704	512	370	342
MAC_6	832 X 624	74,546	49,722	57,280	1152	832	667	624
MAC_7	1024 X 768	74,907	60,150	80,000	1330	1024	803	768
MAC_LC	640 X 480	66,619	34,975	31,338	896	640	525	480
MAC_POR	640 X 870	74,996	68,846	57,280	832	640	918	870
MUSE	1172 X 518I	30,000	33,750	37,125	1172	1024	563	518
MXGA_60	1152 X 864	60,000	54,540	60,000	1456	1152	909	864
MXGA_70	1152 X 864	70,000	63,630	94,500	1480	1152	909	864
MXGA_75	1152 X 864	75,000	67,500	75,000	1600	1152	900	864
MXGA_80	1152 X 864	80,000	76,640	80,000	1440	1152	958	864
MXGA_85	1152 X 864	85,000	77,055	121,5	1576	1152	907	864
VIDEO525	1302 X 239I	29,970	15,734	32,207	1302	1024	263	239
VIDEO625	1024 X 278I	25,000	15,625	31,984	1310	1024	313	278
PAM500	640 X 400	60,000	26,400	22,810	864	640	440	400
PAM800	1120 X 375I	44,936	36,443	50,000	1372	1120	406	375

*Name* : name of file, contains the settings  
*Resolution* : image resolution, when followed by ...I means interlaced.

*FVERT Hz* : vertical frame frequency of the source

*FHOR kHz* : horizontal frequency of the source.

*FPIX MHz* : pixel frequency

*PTOT* : total pixels on one horizontal line

*PACT* : active pixels on one horizontal line

*LTOT* : total lines in one field

*LACT* : active lines in one field

Appendix A : Standard Source Set Up Files

NAME	RESOLUTION	FVERT Hz	FHOR kHz	FPIX MHz	PTOT	PACT	LTOT	LACT
PC98_1	640 X 400	56,416	24,823	21,050	848	640	440	400
PC98_2	1120 X 375I	39,994	32,835	47,840	1457	1120	411	375
PC98_3	1120 X 750	60,000	50,000	78,569	1571	1120	833	750
S1152_66	1152 X 900	66,004	61,846	94,500	1528	1152	937	900
S1152_76	1152 X 900	76,637	71,809	108,000	1504	1152	937	900
SDI_625	675 X 2781	25,000	15,625	13,500	864	720	313	278
SDI_525	675 X 2401	29,970	15,734	13,500	858	720	263	240
SG_60_1	1280 X 1024	60,000	63,900	107,352	1680	1280	1065	1024
SG_60_2	1024 X 768	60,000	48,780	64,390	1320	1024	813	768
SG_60_3	960 X 680	60,000	43,200	54,432	1260	960	720	680
SUNNEWS67	1280 X 1024	67,189	71,691	117,000	1632	1280	1067	1024
SUNNEWS76	1280 X 1024	76,107	81,130	135,000	1664	1280	1066	1024
SUNXGA60	1024 X 768	59,984	48,287	64,125	1328	1024	805	768
SUNXGA70	1024 X 768	70,041	56,596	74,250	1312	1024	808	768
SUNXGA77	1024 X 768	77,069	62,040	84,375	1360	1024	805	768
SUP_MAC	1024 X 768	60,000	48,780	63,999	1312	1024	813	768
SVGA_56V	800 X 600	56,250	35,156	36,000	1024	800	625	600
SVGA_60V	800 X 600	60,317	37,879	40,000	1056	800	628	600
SVGA_72V	800 X 600	72,084	48,080	50,003	1040	800	667	600
SVGA_75	800 X 600	75,000	46,875	75,000	1056	800	625	600
SVGA_85	800 X 600	85,000	53,635	56,250	1048	800	631	600
SVGA_100	800 X 600	100,000	62,800	100,000	1056	800	628	600
VGA_72V	640 X 480	72,800	37,856	31,496	832	640	520	480
VGA_GR	640 X 480	59,941	31,469	25,175	800	640	525	480
VGA_TXT	720 X 400	70,087	31,469	28,322	900	720	449	400
VGA75ISO	640 X 480	75,000	39,375	31,500	800	640	525	480
XGA_60	1024 X 768	60,000	48,360	64,996	1344	1024	806	768
XGA_70	1024 X 768	70,000	57,050	78,044	1368	1024	815	768
XGA_70V	1024 X 768	69,705	56,182	74,610	1328	1024	806	768
XGA_72	1024 X 768	71,955	58,140	80,000	1376	1024	808	768
XGA_75	1024 X 768	75,781	61,080	86,000	1408	1024	806	768
XGA75_GS	1024 X 768	74,534	59,701	79,284	1328	1024	801	768
XGA_85	1024X768	85,000	68,680	94,500	1376	1024	808	768
XGA_100	1024X768	100,000	80,800	100,000	1368	1024	808	768



## LENSES

### Lens Cleaning Procedure

To minimize the possibility of damaging the optical coating or scratching exposed lens surface, we have developed recommendations for cleaning the lens. FIRST, we recommend you try to remove any material from the lens by blowing it off with clean, dry deionized air. DO NOT use any liquid to clean the lenses.

A Toraysee™ cloth is included with the lens kit.

Proceed as follows :

1. Always wipe lenses with a CLEAN Toraysee™ cloth.
2. Always wipe lenses in a single direction. Do not wipe back and forwards across the lens surface as this tends to grind dirt into the coating.
3. Do not leave cleaning cloth in either an open room or lab coat pocket, as doing so can contaminate the cloth.
4. If smears occur when cleaning lenses, replace the cloth. Smears are the first indication of a dirty cloth.
5. Do not use fabric softener when washing the cleaning cloth or softener sheets when drying the cloth.
6. Do not use liquid cleaners on the cloth as doing so will contaminate the cloth.

Order number for a new Toraysee™ cloth : R379058.

Other lenses can also be cleaned safely with this Toraysee™ cloth.

**Lenses**

QFD(1.27:1)	R9840400
QFD(2.5:1)	R9840290
QFD(1.4-2.1:1)	R9840380
QFD(2.1-3.0:1)	R9840390
QFD(3.5-4.5:1)	R9840060
QFD(4.5-6.0:1)	R9840100
QFD(7:1)	R9840410

**Lens formulas to calculate the projector distance.**

QFG(1.27:1)	Metric	$PD = 1.29 \times SW - 0.0195 + 0.00276/SW$
	Inch	$PD = 1.29 \times SW - 0.77 + 42.78/SW$
QFG(2.5:1)	Metric	$PD = 1.324 \times SW - 0.065 + 0.0297/SW$
	Inch	$PD = 1.324 \times SW - 0.77 + 46.03/SW$
QFD(1.4-2.1:1)	Metric	$PD_{min} = 1.44 \times SW + 0.0287 - 0.022/SW$
		$PD_{max} = 2.20 \times SW - 0.01 + 0.02/SW$
	Inch	$PD_{min} = 1.44 \times SW + 1.3 - 34.10/SW$
		$PD_{max} = 2.20 \times SW - 0.39 + 31.0/SW$
QFD(2.1-3.0:1)	Metric	$PD_{min} = 2.13 \times SW - 0.10 + 0.056/SW$
		$PD_{max} = 2.90 \times SW + 0.10 - 0.0745/SW$
	Inch	$PD_{min} = 2.13 \times SW - 0.39 + 86.80/SW$
		$PD_{max} = 2.90 \times SW + 0.39 - 115.47/SW$
QFD(3.5-4.5:1)	Metric	$PD_{min} = 3.374 \times SW - 0.115 + 0.0575/SW$
		$PD_{max} = 4.433 \times SW - 0.133 + 0.0556/SW$
	Inch	$PD_{min} = 3.374 \times SW - 4.53 + 89.12/SW$
		$PD_{max} = 4.433 \times SW - 5.24 + 86.18/SW$
QFD(4.5-6.0:1)	Metric	$PD_{min} = 4.29 \times SW - 0.02 + 0.0009/SW$
		$PD_{max} = 5.86 \times SW + 0.15 + 0.0121/SW$
	Inch	$PD_{min} = 4.29 \times SW - 0.79 + 1.395/SW$
		$PD_{max} = 5.86 \times SW + 5.91 + 18.755/SW$

**Lens program to calculate the projector distance is available on the BARCO website :**  
<http://www.barco.com/project/cusserv/index.htm>

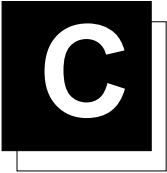

## SOURCE NUMBERS 81 - 86 AND 91 - 96

### Projector without any 800 peripheral connected.

The source numbers 81 - 86 and 91 - 96 do not correspond to physical inputs. An additional adjustment file can be created for these source numbers. This file can contain different settings. The relationship between sources 1 - 6 and 91 - 96 or between 1 - 6 and 81 - 86 is shown in the diagram below.

source input 1	source number 1	file A
	source number 81	file A'
	source number 91	file A''
source input 2	source number 2	file B
	source number 82	file B'
	source number 92	file B''
source input 3	source number 3	file C
	source number 83	file C'
	source number 93	file C''
	•	
	•	
source input 6	source number 6	file F
	source number 86	file F'
	source number 96	file F''

Follow the steps below to create a second or a third file for sources 1 to 6 :

1. Select the source between 1 and 6.
2. Select the corresponding source number between 81 and 86 or 91 and 96 with the digit keys on the RCU.
3. Enter the adjustment mode and load a corresponding file. Edit this file if necessary.
4. Save the file and exit the adjustment mode.

### Projector with a 800 peripheral connected.

#### Source numbers 91 - 99.

The source numbers 91 - 99 do not correspond to physical inputs. An additional adjustment file can be created for these source numbers (source numbers of the 800 peripheral). This file can contain different settings. The relationship between sources 1 - 9 of the 800 peripheral and 91 - 99 is shown in the diagram below.

source input 1	source number 1	file A
	source number 91	file A'
source input 2	source number 2	file B
	source number 92	file B'
source input 3	source number 3	file C
	source number 93	file C'
	•	
	•	
source input 9	source number 9	file I
	source number 99	file I'

Follow the same procedure as for a projector without a 800 peripheral connected.



### Source numbers 81 - 86

Only valid if no input module is connected to slot 81 - 86 of a RCVDS05.

The source numbers 81 - 86 correspond to the physical inputs 1 - 6 of the projector.

e.g. When slot 1 of the projector has to be selected, key in source number 81.

The relationship between the sources of slot 1 - 6 of the projector with 800 peripheral is shown in the table below.

source of slot 1	source number 81
source of slot 2	source number 82
source of slot 3	source number 83
source of slot 4	source number 84
source of slot 5	source number 85
source of slot 6	source number 86