

# SHARP®

MODEL

# UX-300

**FACSIMILE**

OPERATION MANUAL

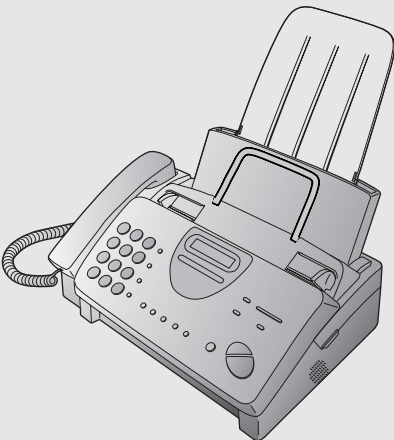

1. Installation
2. Sending Documents
3. Receiving Documents
4. Making Copies
5. Making Telephone Calls
6. Answering Machine Hookup
7. Special Functions
8. Option Settings
9. Printing Reports and Lists
10. Maintenance
11. Troubleshooting

**WARNING** — FCC Regulations state that any unauthorized changes or modifications to this equipment not expressly approved by the manufacturer could void the user's authority to operate this equipment.

**Note:** This equipment has been tested and found to comply with the limits for a Class B digital device, pursuant to Part 15 of the FCC Rules.

These limits are designed to provide reasonable protection against harmful interference in a residential installation.

This equipment generates, uses and can radiate radio frequency energy and, if not installed and used in accordance with the instructions, may cause harmful interference to radio communications. However, there is no guarantee that interference will not occur in a particular installation. If this equipment does cause harmful interference to radio or television reception, which can be determined by turning the equipment off and on, the user is encouraged to try to correct the interference by one or more of the following measures:

- Reorient or relocate the receiving antenna.
- Increase the separation between the equipment and the receiver.
- Connect the equipment into an outlet on a circuit different from that to which the receiver is connected.
- Consult the dealer or an experienced radio/TV technician for help.

## ABOUT THE TELEPHONE CONSUMER PROTECTION ACT OF 1991

"The Telephone Consumer Protection Act of 1991 makes it unlawful for any person to use a computer or other electronic device to send any message via a telephone facsimile machine unless such message clearly contains in a margin at the top or bottom of each transmitted page or on the first page of the transmission the following information:

- (1) The date and time of transmission.
- (2) Identification of either the business, business entity or individual sending the message.
- (3) Telephone number of either the sending machine, business, business entity or individual.

In order to program this information into your facsimile machine, please refer to the appropriate instructions in the operation manual."



As an ENERGY STAR<sup>®</sup> partner, SHARP has determined that this product meets the ENERGY STAR<sup>®</sup> guidelines for energy efficiency.

### FOR YOUR RECORDS

Please record the model number and serial number below, for easy reference, in case of loss or theft. These numbers are located on the rear side of the unit. Space is also provided for other relevant information.

Model Number \_\_\_\_\_

Serial Number \_\_\_\_\_

Date of Purchase \_\_\_\_\_

Place of Purchase \_\_\_\_\_

---

# Introduction

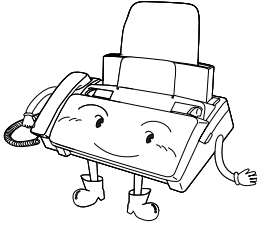

Welcome, and thank you for choosing a Sharp facsimile! The features and specifications of your new Sharp fax are shown below.

## **Automatic dialing**

Rapid Key Dialing: 5 numbers  
Speed Dialing: 40 numbers

## **Imaging film**

**Initial starter roll** (included with fax machine):  
32 ft. (10 m) roll (approx. 30 letter-size pages)

### **Replacement roll:**

**UX-3CR** 98 ft. (30 m) roll (two rolls in package, one roll yields approx. 100 letter-size pages)

## **Automatic document feeder**

10 sheets max.

## **Memory size\*:**

512 KB (approx. 30 average pages)

## **Modem speed**

9600 bps with automatic fallback to 7200, 4800, or 2400 bps

## **Transmission time\***

Approx. 15 seconds (Sharp special mode)

## **Reception modes**

TEL/FAX/A.M. (Note: A.M. mode is for connecting an answering machine)

## **Resolution**

### **Horizontal:**

203 pels/inch (8 pels/mm)

### **Vertical:**

Standard: 98 lines/inch (3.85 lines/mm)

Fine /Halftone:

196 lines/inch (7.7 lines/mm)

Super fine: 391 lines/inch (15.4 lines/mm)

**Note:** The facsimile machine is Year 2000 compliant.

\* Based on ITU-T Test Chart #1 at standard resolution in Sharp special mode, excluding time for protocol signals (i.e., ITU-T phase C time only).

<b>Display</b>	16-digit LCD display
<b>Recording system</b>	Thermal transfer recording
<b>Paper tray capacity (16- to 20-lb. paper)</b>	Letter: 60 sheets Legal: 30 sheets
<b>Halftone (grayscale)</b>	64 levels
<b>Applicable telephone line</b>	Public switched telephone network
<b>Compatibility</b>	ITU-T (CCITT) G3 mode
<b>Compression scheme</b>	MH, MR, Sharp
<b>Scanning method</b>	Sheet-feeder CIS (Contact Image Sensor)
<b>Effective printing width</b>	8.3" (208 mm) max.
<b>Input document size</b>	<b>Automatic feeding:</b> Width: 5.8 to 8.5" (148 to 216 mm) Length: 5.5 to 11" (140 to 279 mm) <b>Manual feeding:</b> Width: 5.8 to 8.5" (148 to 216 mm) Length: 5.5 to 23.6" (140 to 600 mm)
<b>Effective scanning width</b>	8.3" (210 mm) max.
<b>Contrast control</b>	Automatic/Dark selectable
<b>Copy function</b>	Standard
<b>Telephone function</b>	Standard (cannot be used if power fails)
<b>Power requirements</b>	120 V AC, 60 Hz
<b>Operating temperature</b>	41 to 95°F (5 to 35°C)
<b>Humidity</b>	Maximum: 85 %
<b>Power consumption</b>	Stand-by: 4.2 W Maximum: 100 W
<b>Dimensions</b>	Width: 13.5" (343 mm) Depth: 10.1" (256 mm) Height: 7.2" (182 mm)
<b>Weight</b>	Approx. 7.3 lbs. (3.3 kg)

As a part of our policy of continuous improvement, SHARP reserves the right to make design and specification changes for product improvement without prior notice. The performance specification figures indicated are nominal values of production units. There may be some deviations from these values in individual units.

## ***Important safety information***

- Do not disassemble this machine or attempt any procedures not described in this manual. Refer all servicing to qualified service personnel.
- This machine must only be connected to a 120 V, 60 Hz, grounded (3-prong) outlet. Connecting it to any other kind of outlet will damage the machine and invalidate the warranty.
- Do not install or use the machine near water, or when you are wet. Take care not to spill any liquids on the machine.
- Unplug the machine from the power outlet and telephone jack and consult a qualified service representative if any of the following situations occur:
  - Liquid has been spilled into the machine or the machine has been exposed to rain or water.
  - The machine produces odors, smoke, or unusual noises.
  - The power cord is frayed or damaged.
  - The machine has been dropped or the housing damaged.
- Do not allow anything to rest on the power cord, and do not install the machine where people may walk on the power cord.
- Never insert objects of any kind into slots or openings on the machine. This could create a risk of fire or electric shock. If an object falls into the machine that you cannot remove, unplug the machine and consult a qualified service representative.
- Do not place this machine on an unstable cart, stand or table. The machine could be seriously damaged if it falls.
- Never install telephone wiring during a lightning storm.
- Never install telephone jacks in wet locations unless the jack is specifically designed for wet locations.
- Never touch bare telephone wires or terminals unless the telephone line has been disconnected at the network interface.

- Use caution when installing or modifying telephone lines.
- Avoid using a telephone (other than a cordless type) during an electrical storm. There may be a remote risk of electric shock from lightning.
- Do not use a telephone to report a gas leak in the vicinity of the leak.
- The power outlet must be installed near the equipment and must be easily accessible.

**Important:**

- This facsimile machine is not designed for use on a line which has call waiting, call forwarding, or certain other special services offered by your telephone company. If you attempt to use the fax machine in conjunction with any of these services, you may experience errors during transmission and reception of facsimile messages.
- This facsimile machine is not compatible with digital telephone systems.

---

# Table of Contents

<b>1</b>	<b>Installation</b>	<b>7</b>
	Unpacking Checklist . . . . .	7
	A Look at the Operation Panel . . . . .	8
	Connections . . . . .	10
	Loading the Imaging Film . . . . .	16
	Loading Printing Paper . . . . .	21
	Entering Your Name and Fax Number . . . . .	24
	Setting the Date and Time . . . . .	27
	Selecting the Reception Mode . . . . .	30
	Volume Adjustment . . . . .	31
<b>2</b>	<b>Sending Documents</b>	<b>33</b>
	Transmittable Documents . . . . .	33
	Loading the Document . . . . .	35
	Resolution and Contrast . . . . .	37
	Sending a Fax by Normal Dialing . . . . .	39
	Sending a Fax by Automatic Dialing . . . . .	41
<b>3</b>	<b>Receiving Documents</b>	<b>50</b>
	Using FAX Mode . . . . .	50
	Using TEL Mode . . . . .	51
<b>4</b>	<b>Making Copies</b>	<b>56</b>
<b>5</b>	<b>Making Telephone Calls</b>	<b>59</b>
<b>6</b>	<b>Answering Machine Hookup</b>	<b>62</b>
	Connecting an Answering Machine . . . . .	62
	Activating the Answering Machine Hookup . . . . .	63

<b>7</b>	<b>Special Functions</b>	<b>65</b>
	Caller ID . . . . .	65
	Distinctive Ring . . . . .	70
	Broadcasting . . . . .	72
	Cover Sheet . . . . .	74
	Batch Page Numbering . . . . .	77
	Blocking Reception of Unwanted Faxes . . . . .	79
	Sending Documents From Memory . . . . .	81
	Polling (Requesting a Fax Transmission) . . . . .	83
	Timer Operations . . . . .	86
<b>8</b>	<b>Option Settings</b>	<b>88</b>
<b>9</b>	<b>Printing Reports and Lists</b>	<b>96</b>
<b>10</b>	<b>Maintenance</b>	<b>102</b>
<b>11</b>	<b>Troubleshooting</b>	<b>106</b>
	Problems and Solutions . . . . .	106
	Messages and Signals . . . . .	111
	Clearing Paper Jams . . . . .	114
	<b>Ordering parts</b>	<b>117</b>
	<b>FCC Regulatory Information</b>	<b>118</b>
	<b>Quick Reference Guide</b>	<b>119</b>
	<b>Guia de Consulta Rapida</b>	<b>121</b>
	<b>Index</b>	<b>123</b>



**Unpacking Checklist**

Before setting up, make sure you have all of the following items.



If any are missing, contact your dealer or retailer.

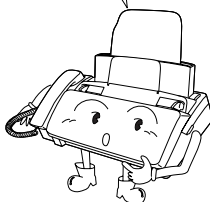

Original document support



Paper tray extension

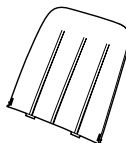

Handset



Rapid key labels



Handset cord

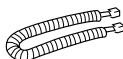

Operation manual

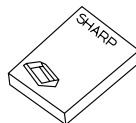

Gears (4)

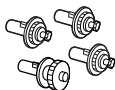

Telephone line cord



Imaging film (initial starter roll)

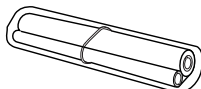

Imaging film cartridge

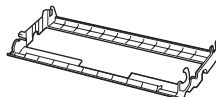

## A Look at the Operation Panel

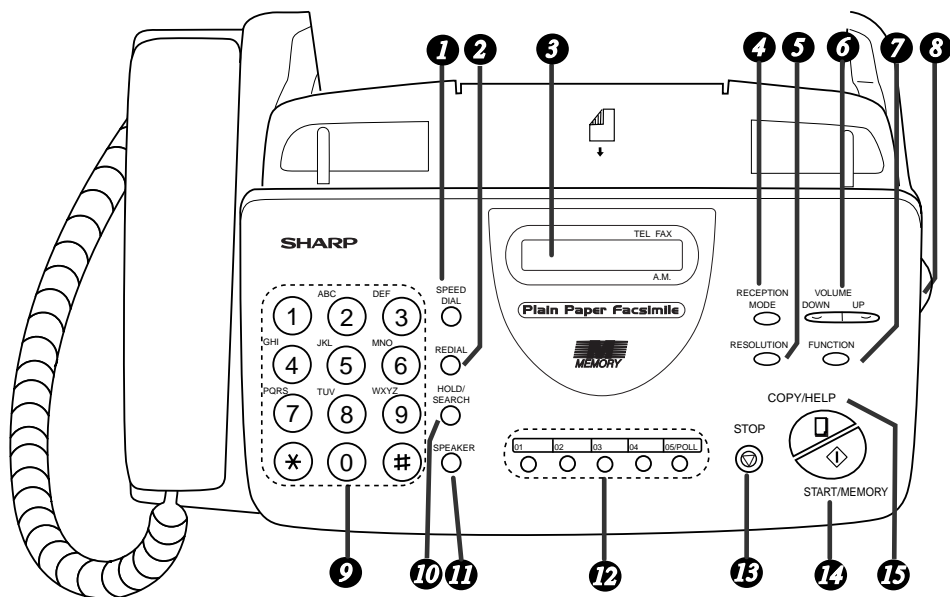

- 1 SPEED DIAL key**  
Press this key to dial a 2-digit Speed Dial number.
- 2 REDIAL key**  
Press this key to automatically redial the last number dialed.
- 3 Display**  
This displays messages and prompts during operation and programming.
- 4 RECEPTION MODE key**  
Press this key to select the reception mode. An arrow in the display will point to the currently selected reception mode.
- 5 RESOLUTION key**  
Press this key to adjust the resolution and contrast before sending or copying a document.

**6 VOLUME keys**

Press these keys to adjust the volume of the handset when the handset is lifted, the volume of the speaker when the **SPEAKER** key has been pressed, or the volume of the ringer at all other times.

**7 FUNCTION key**

Press this key to select various special functions.

**8 Panel release**

Grasp this finger hold and pull toward you to open the operation panel.

**9 Number keys**

Use these keys to dial numbers, and enter numbers and letters during number/name storing procedures.

**10 HOLD/SEARCH key**

Press this key to search for an automatic dialing number, or, during a phone conversation, press this key to put the other party on hold.

**11 SPEAKER key**

Press this key to hear the line and fax tones through the speaker when sending a document.

Note: **This is not a speakerphone.** You must pick up the handset to talk with the other party.

**12 Rapid Dial keys**

Press one of these keys to dial a fax or voice number automatically. (Note that you must attach the Rapid Key labels.)

**13 STOP key**

Press this key to cancel operations before they are completed.

**14 START/MEMORY key**

Press this key to send or receive a document, or to scan a document into memory before sending it.

**15 COPY/HELP key**

When a document is in the feeder, press this key to make a copy. At any other time, press this key to print out the Help List, a quick reference guide to the operation of your fax.

## Connections

### Points to keep in mind when setting up

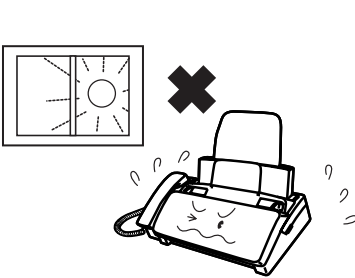

Do not place the machine in direct sunlight.

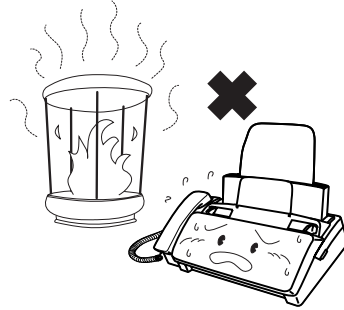

Do not place the machine near heaters or air conditioners.

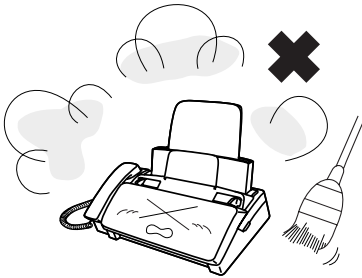

Keep dust away from the machine.

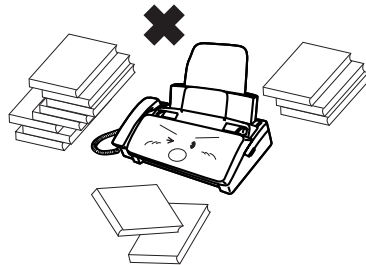

Keep the area around the machine clear.

### About condensation

If the machine is moved from a cold to a warm place, it is possible that condensation may form on the scanning glass, preventing proper scanning of documents for transmission. To remove the condensation, turn on the power and wait approximately two hours before using the machine.

## Handset

Connect the handset as shown and place it on the handset rest.

- ◆ The ends of the handset cord are identical, so they will go into either jack.

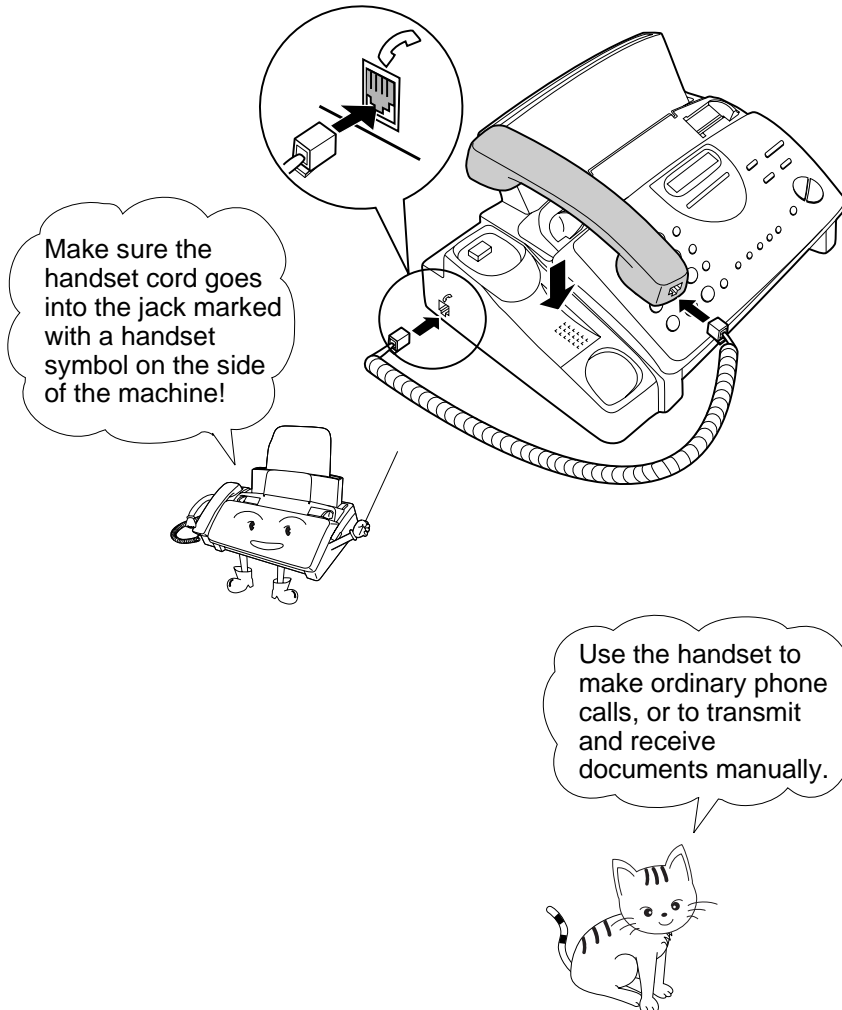

**Power cord**

Plug the power cord into a 120 V, 60 Hz, grounded (3-prong) AC outlet.

**Caution!**

Do not plug the power cord into any other kind of outlet. This will damage the machine and is not covered under the warranty.

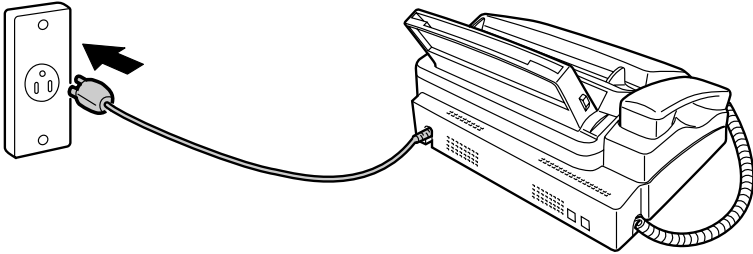

The machine does not have a power on/off switch, so the power is turned on and off by simply plugging in or unplugging the power cord.

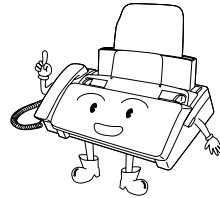

**Note:** If your area experiences a high incidence of lightning or power surges, we recommend that you install surge protectors for the power and telephone lines. Surge protectors can be purchased at most telephone specialty stores.

## Telephone line cord

Insert one end of the line cord into the jack on the back of the machine marked **TEL. LINE**. Insert the other end into a standard (RJ11C) single-line wall telephone jack.

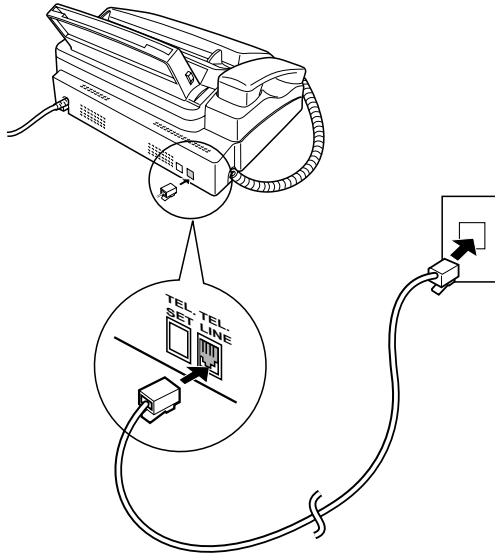

Be sure to insert the telephone line cord into the **TEL. LINE** jack. **Do not** insert it into the **TEL. SET** jack!

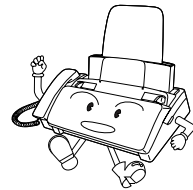

### Comments:

- Your fax is set for touch-tone dialing. If you are on a pulse dial (rotary) line, you must set the fax for pulse dialing by changing Option Setting 8. This procedure is described in Chapter 8, *Option Settings*.
- If you intend to use a computer fax modem on the same phone line, you must reset Option Setting 12 (Fax Signal Receive) to NO in order to prevent transmission and reception errors. This procedure is described in Chapter 8, *Option Settings*.

## Trays

Attach the paper tray extension.

- ◆ Pull the paper release plate forward. Insert the paper tray extension horizontally into the notches in the paper tray. Rotate the paper tray extension up until it snaps into place.

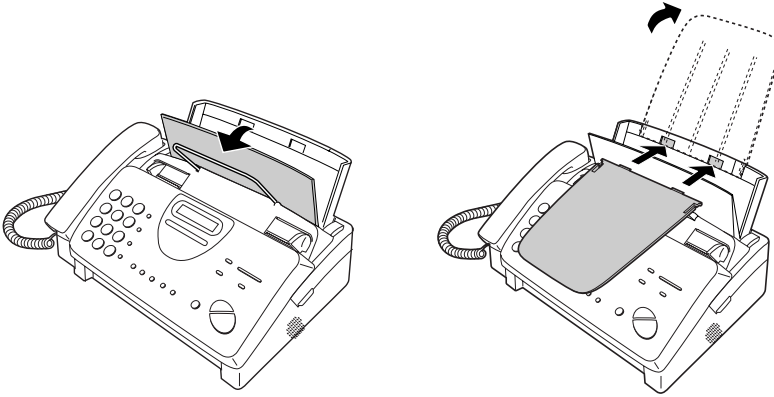

Attach the original document support.

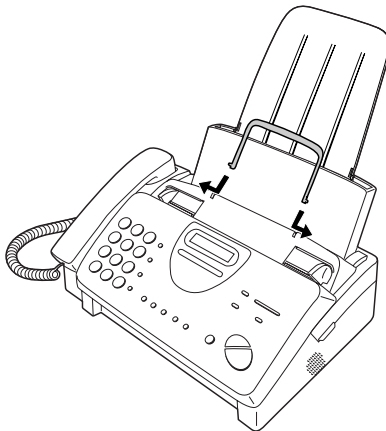

Note: The original document support has a top side and a bottom side. If you cannot insert the tabs on the support into the holes, turn the support over.



### **Extension phone (optional)**

If desired, you can connect an extension phone to the **TEL. SET** jack on the fax.

- ◆ To connect an answering machine to your fax, see Chapter 6, *Answering Machine Hookup*.

- 1** Remove the seal covering the **TEL. SET** jack.

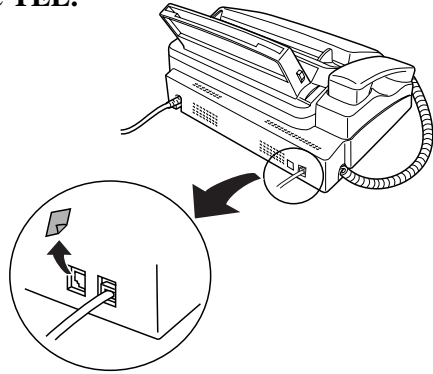

- 2** Connect the extension phone line to the **TEL. SET** jack.

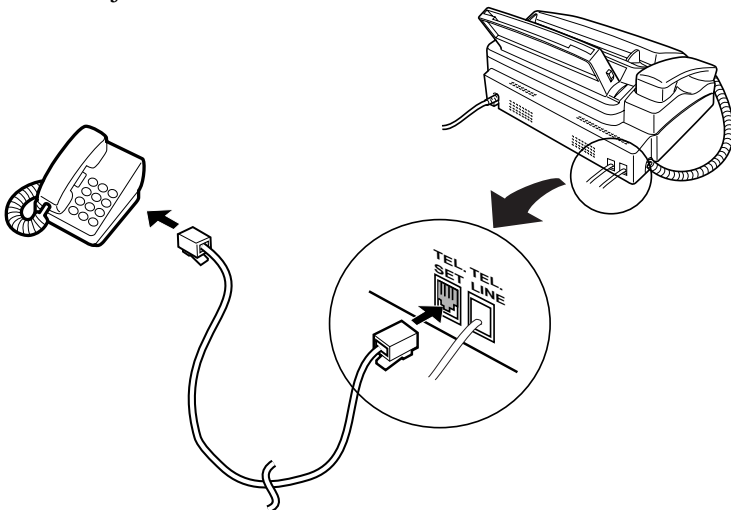

## Loading the Imaging Film

Your fax uses a roll of imaging film to create printed text and images. The print head in the fax applies heat to the imaging film to transfer ink to the paper. Follow the steps below to load or replace the film.

The initial starter roll of imaging film included with your fax can print about 30 letter-size pages.



When replacing the film, use a roll of Sharp UX-3CR imaging film. One roll can print about 100 letter-size pages.



**Note:** If there is paper in the paper tray, pull the paper release plate forward and remove the paper before loading the imaging film.

- 1 Open the operation panel by grasping the finger hold and pulling up.

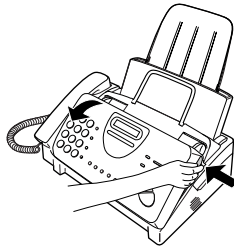

- 2 Pull the green release on the right side of the machine forward, and open the print compartment cover.

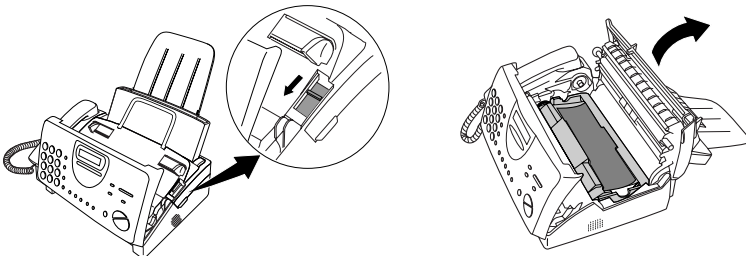

If you are installing the imaging film for the first time, go to Step 6.

- 3** Remove the imaging film cartridge from the print compartment (grasp the handle at the front of the cartridge) and turn it over.

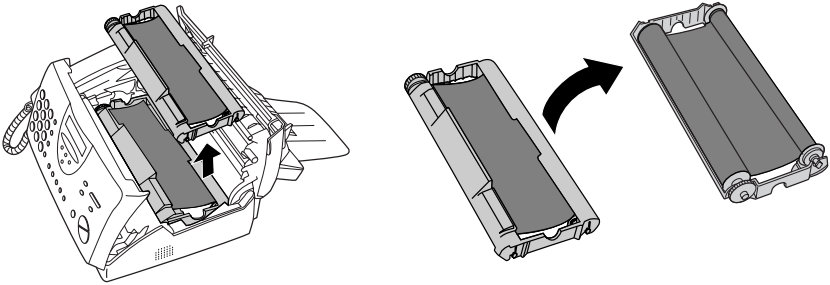

- 4** Remove the used film from the cartridge.

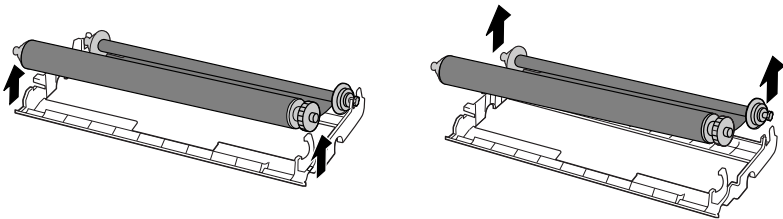

- 5** Remove the four green gears from the used film.  
**DO NOT DISCARD THE FOUR GREEN GEARS!**

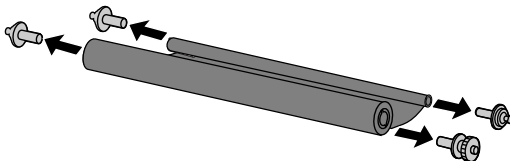

- 6** Remove the new roll of imaging film from its packaging.
  - Do not yet remove the band that holds the rolls together.

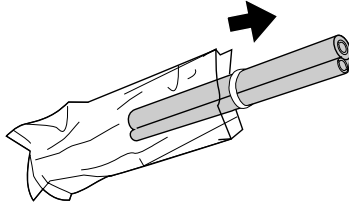

- 7** Insert the large gear into the green end of the empty spool. Make sure the two protrusions on the large gear fit firmly into the slots in the end of the spool.

Insert the remaining three gears into the spools, making sure the protrusion on each gear fits firmly into one of the slots in the end of each spool.

- If needed, pull the spools apart slightly to allow the gears to fit (the band will stretch).

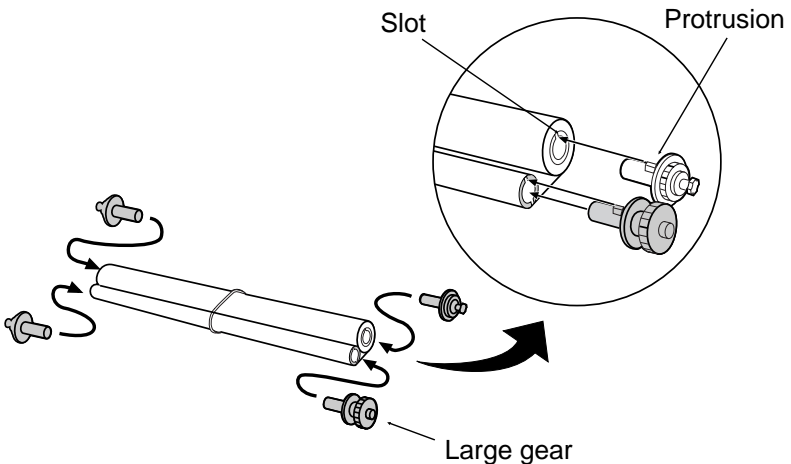

- 
- 8** Insert the large gear into the large holder on the imaging film cartridge (make sure it clicks into place), and then insert the small gear on the other end of the spool into its holder.

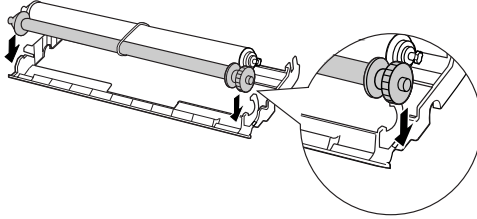

- 
- 9** Cut the band that holds the two spools together. Unroll the film slightly and insert the small gears into their holders.

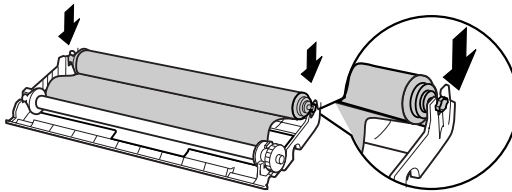

- 
- 10** Turn the cartridge over, grasp the handle, and insert the cartridge into the print compartment.

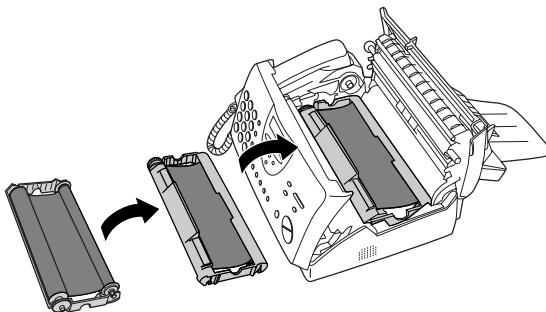

**11** Rotate the large gear toward you until the film is taut.

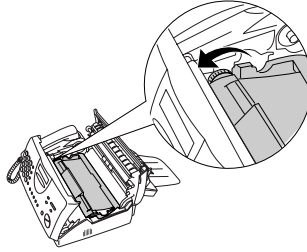

**12** Close the print compartment cover (press down on both sides to make sure it clicks into place), and then close the operation panel.

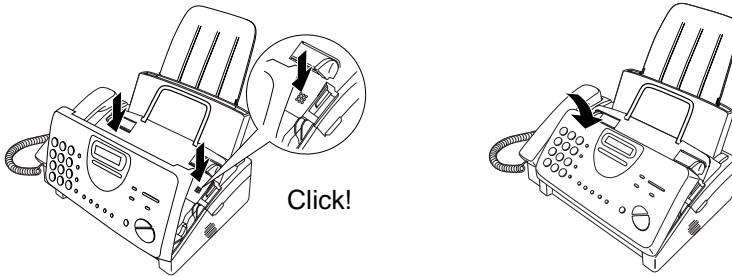

**13** Load paper in the paper tray and then press the following keys to initialize the film.

**Note:** Paper must be loaded before the film can be initialized. To load paper, see the following section, *Loading the Printing Paper*.

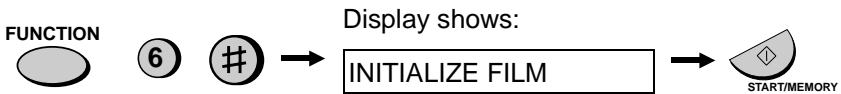

### ***When to replace the imaging film***

Replace the imaging film when the display shows:

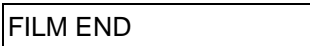

Use the following imaging film, which is available from your dealer or retailer:

**Sharp UX-3CR Imaging Film**

## Loading Printing Paper

You can load letter or legal size paper in the paper tray. The maximum number of sheets depends on the weight and size of the paper you are loading.

- ◆ Paper from 16 to 20 lbs. (60 to 75 g/m<sup>2</sup>):  
Letter size: 60 sheets      Legal size: 30 sheets
- ◆ Paper from 20 to 24 lbs. (75 to 90 g/m<sup>2</sup>):  
Letter size: 50 sheets      Legal size: 25 sheets

- 
- 1** Fan the paper, and then tap the edge against a flat surface to even the stack.

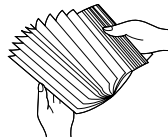

- 
- 2** Pull the paper release plate toward you.



- 
- 3** Insert the stack of paper into the tray, **print side down**.

- If paper remains in the tray, take it out and combine it into a single stack with the new paper before adding the new paper.

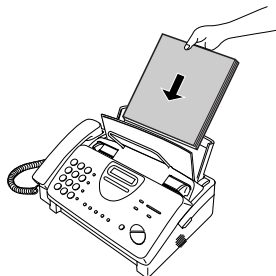

Be sure to load the paper so that printing takes place on the **print** side of the paper. Printing on the reverse side may result in poor print quality.

- 4** Push the paper release plate back down.

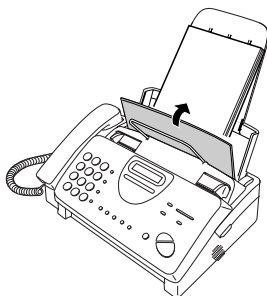

If the paper release plate is not pushed down, paper feed errors will result.

**Note:** When receiving faxes or copying documents, do not allow a large number of pages to accumulate in the output tray. This may obstruct the outlet and cause paper jams.

- 5** The fax has been set at the factory to scale the size of received faxes to letter size paper. If you have loaded legal paper, you must change the paper size setting to legal. Press these keys:



The display will show: PAPER SIZE SET

Press **1** to select LETTER or **2** to select LEGAL.

LETTER    LEGAL  
**1**    or    **2**

The display will show: COPY CUT-OFF

Press the **STOP** key to return to the date and time display.





- 6** Your fax has been set at the factory to print at normal contrast. Depending on the type of paper you have loaded, you may find that you obtain better print quality by changing the setting to LIGHT. Press these keys:

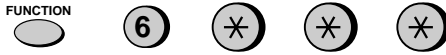

The display will show:

Press **1** to select NORMAL or **2** to select LIGHT.

NORMAL    LIGHT  
 **1**    or     **2**

The display will show:

Press the **STOP** key to return to the date and time display.



## Entering Your Name and Fax Number

Before you can begin using your fax, you need to enter your name and the telephone number of your fax. You also need to set the date and time.



Once you enter this information, it will automatically appear at the top of each fax page you send.

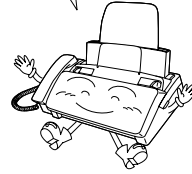

### Important!

The law requires that your name, telephone/fax number, and the date and time appear on each fax message you send. Enter your name and fax number here and set the date and time as explained in the following section to have your fax include this information automatically at the top of your fax messages.

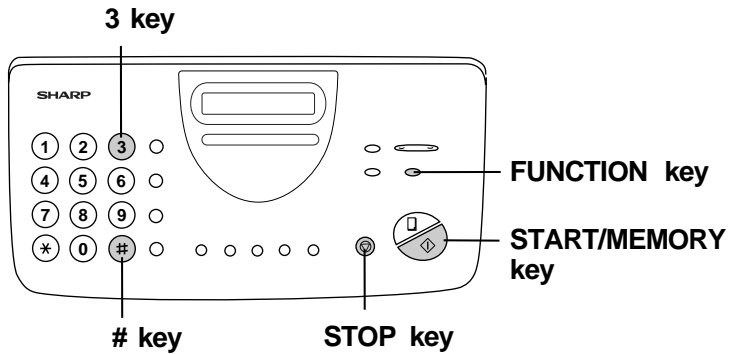

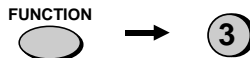

**Note:** The imaging film and printing paper must be loaded before your name and fax number can be entered.

**1** Press these keys:



The display will show: ENTRY MODE

- 2** Press the # key twice:  

The display will show:

- 3** Press the **START/MEMORY** key.



The display will show:

- 4** Enter your fax number by pressing the number keys. Up to 20 digits can be entered.

- To insert a space between digits, press the # key.
- If you make a mistake, press the **HOLD/SEARCH** key to move the cursor back to the mistake and then enter the correct number. The new number will replace the old number.

Example:        

- 5** Press the **START/MEMORY** key to enter the fax number in memory.























































































The display will show:













**Cursor:** A dark square mark in the display that indicates where a number or letter will be entered.

**6** Enter your name by pressing the number keys as shown in the chart below. Up to 24 characters can be entered.

- To enter two letters in succession that require the same key, press the **SPEAKER** key after entering the first letter.

Example: SHARP = 7 7 7 7 7 4 4 4 2 2 7 7 7 7  7 7

A =  	J =  	S =     
B =   	K =   	T =  
C =    	L =    	U =   
D =  	M =  	V =    
E =   	N =   	W =  
F =    	O =    	X =   
G =  	P =  	Y =    
H =   	Q =   	Z =     
I =    	R =    	SPACE =  

 ABC	 DEF		Press this key to delete the letter highlighted by the cursor.
 GHI	 JKL		Press this key to change case.
 PQRS	 TUV		Press this key to move the cursor to the left.
 OPER			Press this key to move the cursor to the right.

Press either key repeatedly to select one of the following symbols:  
 ./!"#\$\$%&'()\*+,-.:;<=>?@[ \ ] ^ \_ { | } → ←

**7** Press the **START/MEMORY** key to save your name in memory.



The display will show: SECURITY SELECT

**8** Press the **STOP** key to return to the date and time display.



## Setting the Date and Time

The date and time appear in the display and reports, and are printed at the top of every page you fax.

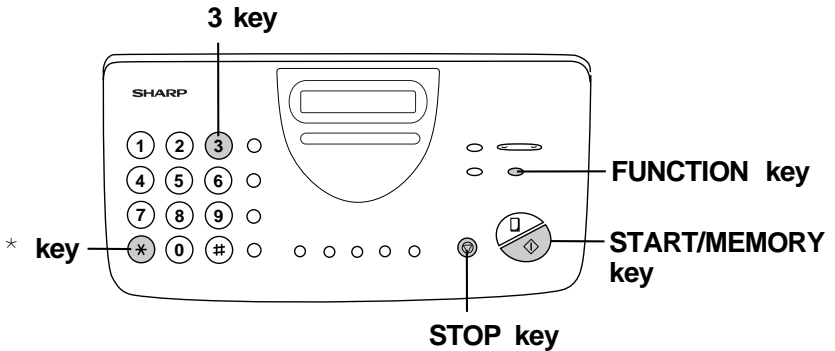
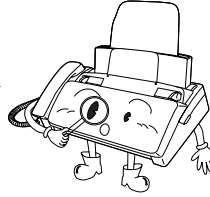

**Note:** The imaging film and printing paper must be loaded before the date and time can be set.

- 1** Press these keys:

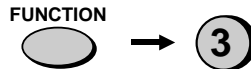

The display will show: ENTRY MODE

- 2** Press the \* key four times.



The display will show: DATE & TIME SET

**Note:** The fax is Year 2000 compliant.

**3** Press the **START/MEMORY** key.



- The currently set date will appear in the display.
- 

**4** Enter a two-digit number for the month ("01" for January, "02" for February, "12" for December, etc.).

- To correct a mistake, press the **SPEED DIAL** key to move the cursor back to the mistake, and then enter the correct number.

Example: January    **0**    **1**

---

**5** Enter a two-digit number for the day ("01" to "31").

Example: the 5th    **0**    **5**

---

**6** Enter the year (four digits).

Example: 1999    **1**    **9**    **9**    **9**

---

**7** Enter a two-digit number for the hour ("01" to "12") and a two-digit number for the minute ("00" to "59").

Example: 9:25    **0**    **9**    **2**    **5**

---

**8** Press the \* key to select A.M. or the # key to select P.M.

A.M.                  P.M.  
**\***    or    **#**

- 9** Press the **START/MEMORY** key to start the clock.



The display will show: DAY LIGHT SAVING

- 10** Press the **STOP** key to return to the date and time display.



### Daylight Saving Time

If desired, you can have the clock move forward and backward automatically at the beginning and end of Daylight Saving Time. To turn on this function, press the panel keys as follows:

- 1** Press these keys:



The display will show: ENTRY MODE

- 2** Press the \* key three times.



The display will show: DAY LIGHT SAVING

- 3** Press **1** to turn on the Daylight Saving Time function, or **2** to turn it off.

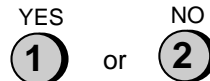

The display will show: STORE JUNK #

- 4** Press the **STOP** key to return to the date and time display.



## Selecting the Reception Mode

Your fax has three modes for receiving incoming calls and faxes:

### TEL mode:

Select this mode when you want to receive both phone calls and faxes on the line connected to the fax machine. **All calls, including faxes, must be answered by picking up the fax machine's handset** or an extension phone connected to the same line.

### FAX mode:

Select this mode when you only want to receive faxes on your line. The fax machine will automatically answer all calls on four rings and receive incoming faxes.

### A.M. mode:

Use this mode only if you have connected an answering machine to the fax (see Chapter 6). Select this mode when you go out to receive voice messages in your answering machine and faxes on your fax machine.

## Setting the reception mode

Press the **RECEPTION MODE** key until the arrow in the display points to the desired mode.

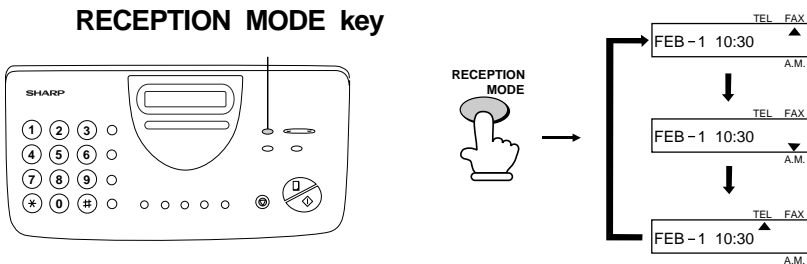

For more information on receiving faxes in TEL and FAX modes, see Chapter 3, *Receiving Documents*. For more information on using A.M. mode, see Chapter 6, *Answering Machine Hookup*.



## Volume Adjustment

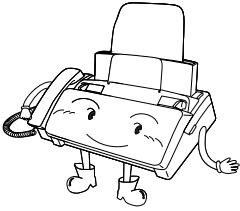

You can adjust the volume of the speaker, handset, and ringer using the **UP** and **DOWN** keys.

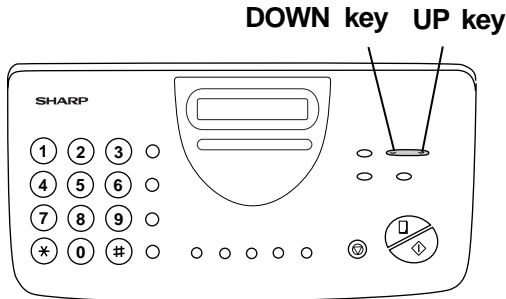

### Speaker

- 1 Press the **SPEAKER** key.

SPEAKER



- 2 Press the **UP** or **DOWN** key.

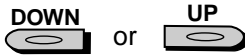

Display:

SPEAKER: HIGH



SPEAKER: MIDDLE



SPEAKER: LOW

- 3 When the display shows the desired volume level, press the **SPEAKER** key to turn off the speaker.

SPEAKER



## Handset

**1** Lift the handset.

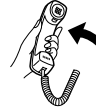

**2** Press the **UP** or **DOWN** key.

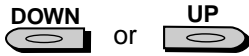

Display:

RECEIVER: HIGH



RECEIVER: MIDDLE

**3** When the display shows the desired volume level, replace the handset.

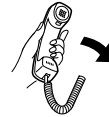

## Ringer

**1** Press the **UP** or **DOWN** key. (Make sure the **SPEAKER** key has not been pressed and the handset is not lifted.)

- The ringer will ring once at the selected level, then the date and time will reappear in the display.

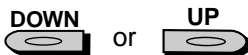

Display:

RINGER: HIGH



RINGER: MIDDLE



RINGER: LOW



RINGER OFF: OK?

**2** If you selected RINGER OFF: OK?, press the **START/MEMORY** key.



# Sending Documents

## Transmittable Documents

### Size and weight

The size and weight of documents that you can load in the document feeder depend on whether you load one page at a time or several pages at once.

#### Loading one page at a time:

Minimum size

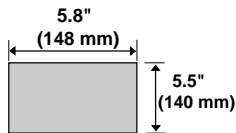

Maximum size

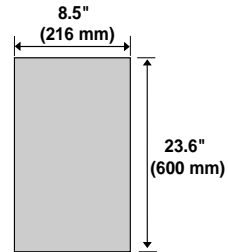

Minimum weight

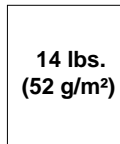

Maximum weight

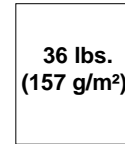

#### Loading several pages at once:

Minimum size

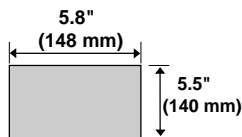

Maximum size

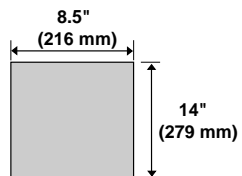

Minimum weight

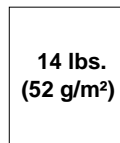

Maximum weight

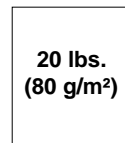

**Note:** Letters or graphics on the edges of a document will not be scanned.

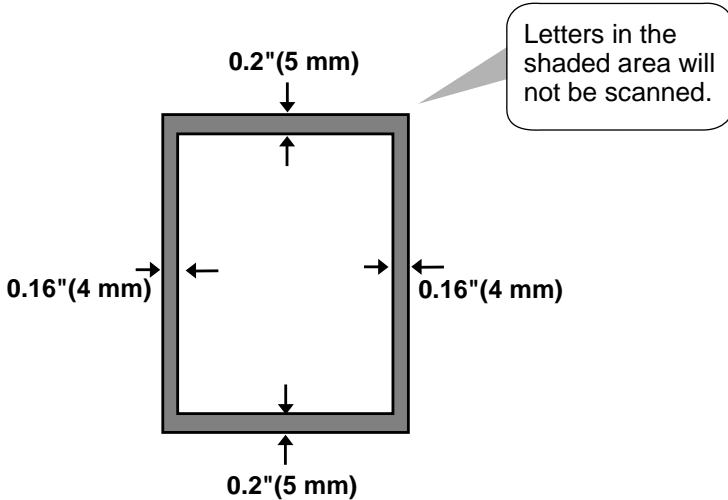

### ***Other restrictions***

- ◆ The scanner cannot recognize yellow, greenish yellow, or light blue ink.
- ◆ Ink, glue, and correcting fluid on documents must be dry before they pass through the document feeder.
- ◆ All clips, staples, and pins must be removed from documents before loading in the feeder. If these are not removed, they may damage the machine.
- ◆ Documents which are patched, taped, torn, smaller than the minimum size, carbon backed, easily smudged, or have a slippery coated surface should be photocopied, and the copy loaded in the feeder.

## Loading the Document

Up to 10 pages can be placed in the feeder at one time. The pages will automatically feed into the machine starting from the bottom page.

- ◆ If you need to send or copy more than 10 pages, place the additional pages gently and carefully in the feeder just before the last page is scanned. Do not try to force them in, as this may cause double-feeding or jamming.
- ◆ If your document consists of several large or thick pages which must be loaded one at a time, insert each page into the feeder as the previous page is being scanned. Insert gently to prevent double-feeding.

- 
- 1** Adjust the document guides to the width of your document.



- 
- 2** Place the document face down and push it gently into the document feeder. The top edge of the document should enter the machine first.

- The feeder will draw the leading edge of the document into the machine. The display will show:

READY TO SEND

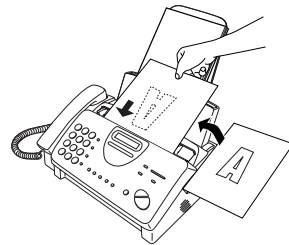

- 
- 3** Adjust the resolution and/or contrast setting (if desired) as explained in the section *Resolution and Contrast*, then dial the receiving machine as explained in *Sending a Fax by Normal Dialing*.



## ***Removing a document from the feeder***

If you need to remove a document from the feeder, open the operation panel.

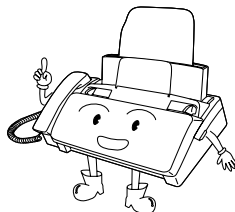

### **Important:**

Do not try to remove a document without opening the operation panel. This may damage the feeder mechanism.

- 
- 1** Open the operation panel by grasping the finger hold and pulling up.

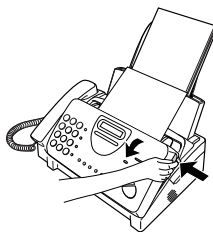

- 
- 2** Remove the document.

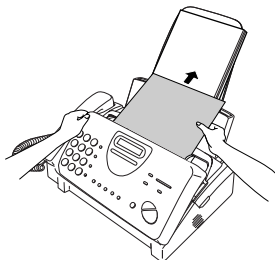

- 
- 3** Close the operation panel, making sure it clicks into place.

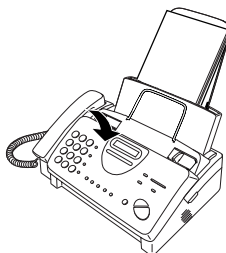

Click!

## Resolution and Contrast

If desired, you can adjust the resolution and contrast before sending a document.

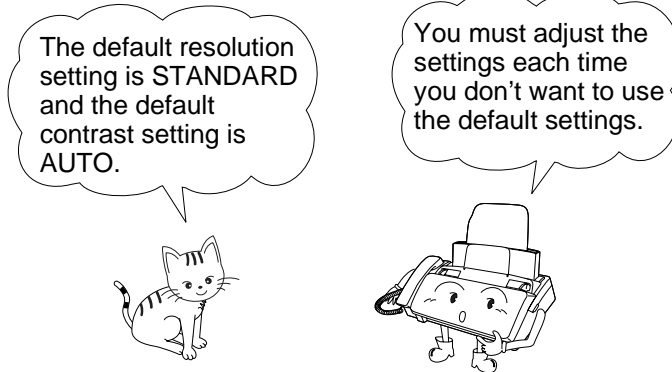

**Note:** The resolution and contrast settings are only effective for transmitting a document. They are not effective for receiving a document.

### Resolution settings

- STANDARD:** Use STANDARD for ordinary documents. This setting gives you the fastest and most economical transmission.
- FINE:** Use FINE for documents containing small letters or fine drawings.
- SUPER FINE:** Use SUPER FINE for documents containing very small letters or very fine drawings.
- HALF TONE:** Use HALF TONE for photographs and illustrations. The original will be reproduced in 64 shades of gray.

### Contrast settings

- AUTO** Use AUTO for normal documents.
- DARK** Use DARK for faint documents.

**1** Load the document(s).

- The document must be loaded before the resolution and contrast can be adjusted.

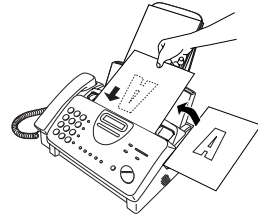

**2** Press the **RESOLUTION** key one or more times until the desired resolution and contrast settings appear in the display.

- The first time you move through the list of resolution settings, the contrast setting **AUTO** will appear next to each resolution setting. The second time you move through the list, the contrast setting **DARK** will appear.

RESOLUTION



Display:

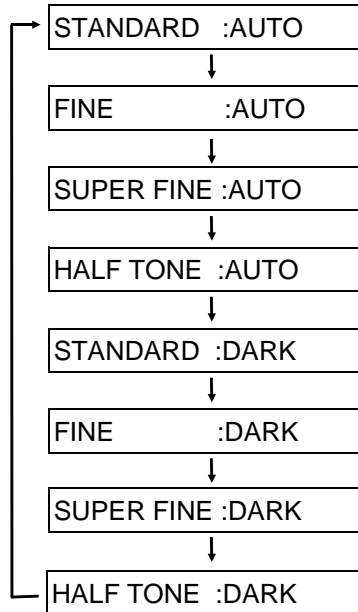

**Note:** In order to transmit in SUPER FINE resolution, the receiving fax machine must also have that resolution. If it doesn't, your machine will automatically step down to the next best available setting.



## Sending a Fax by Normal Dialing

With Normal Dialing, you pick up the handset (or press the **SPEAKER** key) and dial by pressing the number keys.

- ◆ If a person answers, you can talk with them through the handset before sending the fax. (If you pressed the **SPEAKER** key, you must pick up the handset to talk.)
- ◆ Normal Dialing allows you to listen to the line and make sure the other fax machine is responding.

### 1 Load the document(s).

The display will show:

READY TO SEND

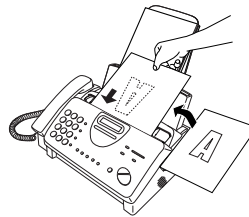

- Set the resolution and/or contrast if desired.

RESOLUTION



### 2 Pick up the handset or press the **SPEAKER** key. Listen for the dial tone.

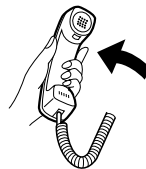

or

**SPEAKER**



### 3 Dial the number of the receiving machine by pressing the number keys.

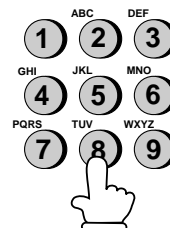

**4** Wait for the connection. Depending on the setting of the receiving machine, you will either hear a facsimile reception tone or the other person will answer.

- If the other party answers, ask them to press their Start key (if you pressed the **SPEAKER** key, pick up the handset to speak with them). This causes the receiving machine to issue a reception tone.

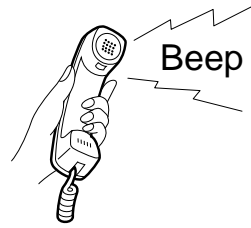

---

**5** When you hear the reception tone, press the **START/MEMORY** key. Replace the handset if you used it.

- When transmission is completed, the fax will beep once.



### ***Using the REDIAL key***

You can press the **REDIAL** key to redial the last number dialed. To send a document, proceed from Step 4 of Normal Dialing. Note that the speaker will be automatically activated when you press the **REDIAL** key.

**Facsimile reception tone:** This is a pronounced, high-pitched tone that the receiving machine sends to the transmitting machine to indicate that it is ready to receive.

## Sending a Fax by Automatic Dialing

You can dial a fax or telephone number by simply pressing a Rapid Key, or by pressing the **SPEED DIAL** key and entering a two-digit number.

- ◆ To use Automatic Dialing, you must first store the full fax or telephone number in your fax machine.
- ◆ When you store a fax or telephone number, you select a two-digit Speed Dial number for it. 45 Speed Dial numbers are available.

Speed Dial numbers 01 through 05 are for Rapid Key (one-touch) Dialing.



Speed Dial numbers 06 through 45 are for dialing with the **SPEED DIAL** key.

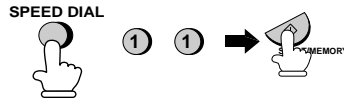

SPEED DIAL key

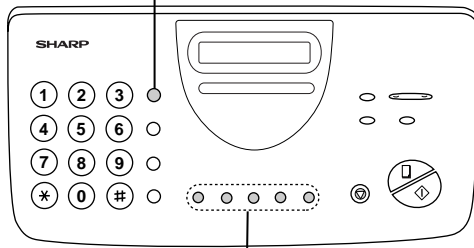

Attach the strip of Rapid Key labels above the Rapid Keys.

Rapid keys

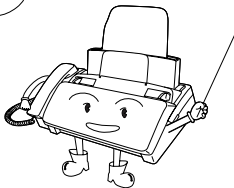

When you store a number in a Rapid Key, write the name of the party on the label.

## Storing fax and telephone numbers for Automatic Dialing

---

**1** Press these keys:



The display will show: FAX/TEL. # MODE

---

**2** Press **1** to select SET.



The display will show: FAX/TEL. # SET



ENTER SPEED #

---

**3** Enter a two-digit Speed Dial number by pressing the number keys (01 to 05 for Rapid Key Dialing, 06 to 45 for Speed Dialing).



(Example)

---

**4** Enter the fax or voice number by pressing the number keys (max. of 32 digits including pauses). (Note: A space cannot be entered.)

- Press the **SPEED DIAL** key to clear a mistake.
- If a pause is required between any of the digits to access a special service or an outside line, press the **REDIAL** key (two seconds per pause). The pause will appear as a hyphen. Several pauses can be entered in a row.



(Example)

---





















































































**5** Press the **START/MEMORY** key.



**6** Enter the name of the party by pressing the number keys as shown in the chart below. Up to 20 characters can be entered.

- If you don't want to enter a name, skip this step.
- To enter two letters in succession that require the same key, press the **SPEAKER** key after entering the first letter.

Example: SHARP = 7 7 7 7 7 4 4 4 2 2 7 7 7 7  7 7

A =  	J =  	S =     
B =   	K =   	T =  
C =    	L =    	U =   
D =  	M =  	V =    
E =   	N =   	W =  
F =    	O =    	X =   
G =  	P =  	Y =    
H =   	Q =   	Z =     
I =    	R =    	SPACE =  

**7** Press the **START/MEMORY** key.



**8** Return to Step 3 to store another number, or press **STOP** to exit. If the number will be used for Rapid Key Dialing, you can write the name on the appropriate Rapid Key label.

Step 3 or



### **Storing area codes and access codes**

You can also store an area code or access code in a Rapid Key or Speed Dial number. To use this number to dial, see *Chain Dialing* in Chapter 5, *Making Telephone Calls*.

**Note:** An area code or access code stored in a Rapid Key or Speed Dial number can only be used if the handset is lifted or the **SPEAKER** key pressed before dialing.

## Clearing numbers

---

**1** Press these keys:

FUNCTION



The display will show: FAX/TEL. # MODE

---

**2** Press **2** to select CLEAR.



**3** Enter the Speed Dial number that you want to clear by pressing the number keys.



(Example)

---

**4** Press the **START/MEMORY** key.



**5** Return to Step 3 to clear another number, or press **STOP** to exit.

Step 3 or



## Making changes

To make changes in a number previously stored, repeat the storing procedure. Select the Speed Dial number for which you want to make changes in Step 3, and then change the number and/or name when they appear in the display (Steps 4 and 6, respectively).

- ◆ A lithium battery keeps automatic dialing numbers in memory  
The machine uses a lithium battery to keep automatic dialing numbers and other programmed data in memory when the power is turned off. Battery power is consumed primarily when the power is off. With the power kept continuously off, the life of the battery is about 5 years. If the battery dies, have your dealer or retailer replace it. Do not try to replace it yourself.

## Rapid Key Dialing

If the number you want to dial has been stored for Automatic Dialing as a Speed Dial number from 01 to 05, you can dial it by pressing the corresponding Rapid Key.

### 1 Load the document(s).

The display will show:

READY TO SEND

- Set the resolution and/or contrast if desired.

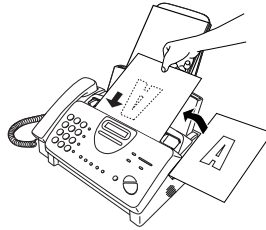

RESOLUTION



### 2 Press the Rapid Key corresponding to the desired Speed Dial number.

- The name of the receiving party will appear in the display. If no name was stored, the fax number will appear. (If the name or number is incorrect, press the **STOP** key.)
- The document will be automatically transmitted once the connection is made.

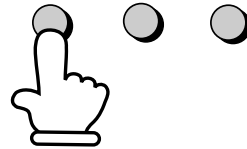
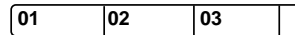

**Example:** To dial Speed Dial number 01, press Rapid Key 01.

## Speed Dialing

Speed Dialing can be used to dial any number that has been stored for Automatic Dialing.

---

### 1 Load the document(s).

The display will show:

READY TO SEND

- Set the resolution and/or contrast if desired.

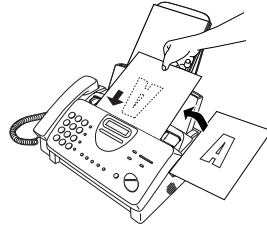

### 2 Press the **SPEED DIAL** key and then enter the two digits of the Speed Dial number by pressing the number keys.

- To enter numbers 1 through 9, first enter 0 and then the number.

SPEED DIAL



2

0

(Example)

### 3 Check the display. If the name or number shown is correct, press the **START/MEMORY** key. (If not, press the **STOP** key and then repeat Step 2.)





## Direct Keypad Dialing

You can also enter a full number with the number keys and then press the **START/MEMORY** key to begin dialing. You can use this method to dial a full number when you don't need to speak to the other party before faxing.

### 1 Load the document(s).

The display will show:

READY TO SEND

- Set the resolution and/or contrast if desired.

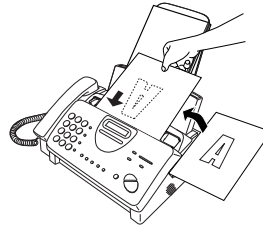

### 2 Enter the number of the receiving machine by pressing the number keys.

- If a pause is required between any of the digits to access a special service or an outside line, press the **REDIAL** key (two seconds per pause). The pause will appear as a hyphen. Several pauses can be entered in a row.

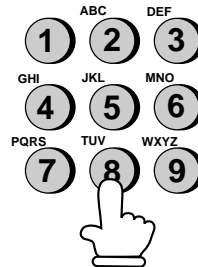

### 3 Check the display. If the number of the receiving machine shown is correct, press the **START/MEMORY** key.

- If it is not correct, press the **STOP** key to backspace and clear one digit at a time, and then re-enter the correct digit(s).



## Using the HOLD/SEARCH key

If you don't remember the Rapid Key or Speed Dial number in which you have stored a particular fax number, you can search for the number by following the steps below. Once you have found the number, you can dial it and transmit the loaded document by simply pressing the **START/MEMORY** key.

### 1 Load the document(s).

The display will show:

READY TO SEND

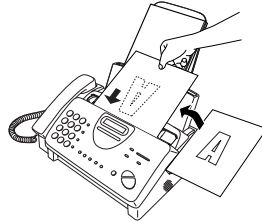

- Set the resolution and/or contrast if desired.



### 2 Press the **HOLD/SEARCH** key and then the **1** key.

HOLD/SEARCH



### 3 Enter the first letter of the stored name by pressing the appropriate number key (the key below the marked letter) one or more times until the letter appears in the display. If the name begins with a special character or number, press **1**.

- If you don't remember the first letter, go to Step 4 (you will scroll through the list from the beginning).
- If a name wasn't stored for the number, press **0**. This will cause numbers, not names, to appear when you scroll.

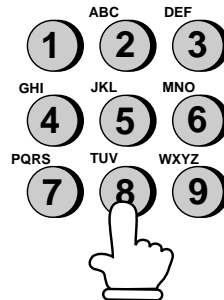

**4** Press the # key or the \* key to scroll through the names (numbers if you pressed 0). Stop when the desired name appears in the display.

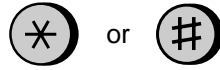

- If no names have been stored that begin with the entered letter, you will scroll from the next name, in alphabetical order, in the list. If no names/numbers have been stored at all, NO DATA will appear.

**5** Press the **START/MEMORY** key. The document will be automatically transmitted once the connection is made.

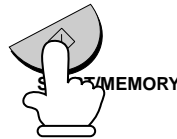

### ***Automatic redialing***

If you use automatic dialing (including Direct Keypad Dialing) and the line is busy, the machine will automatically redial the number. The machine has been set at the factory to make 2 redialing attempts at intervals of 5 minutes.

- ◆ To stop automatic redialing, press the **STOP** key.
- ◆ If desired, you can change the number of times the machine redials with Option Setting 4, and the interval at which redialing takes place with Option Setting 3. See Chapter 8, *Option Settings*.

## Receiving Documents

### Using FAX Mode

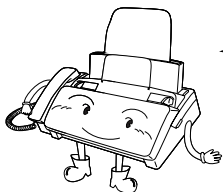

Press the **RECEPTION MODE** key until the arrow in the display points to FAX.

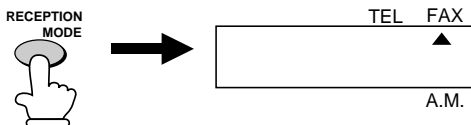

When the reception mode is set to FAX, the machine will automatically answer all calls on four rings and receive incoming faxes.

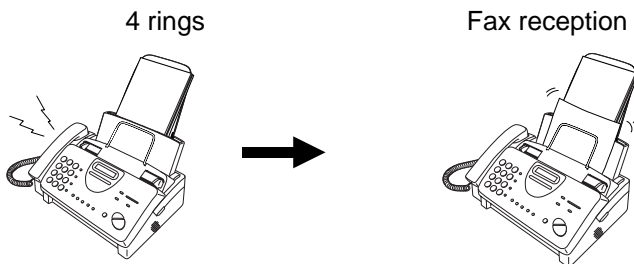

- ◆ You can change the number of rings on which the machine answers calls by changing Option Setting 2. (See Chapter 8, *Option Settings*.)
- ◆ If you pick up the handset before the machine answers, you can talk to the other party and/or receive a document as described in *Using TEL mode*.

**Note:** If you are using distinctive ring, the machine will answer incoming calls after two rings regardless of the setting of Option Setting 2.

## Using TEL Mode

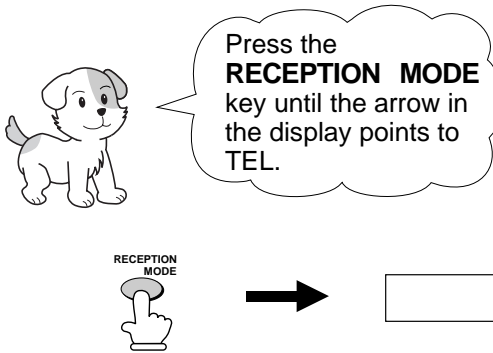

When the reception mode is set to TEL, you must answer all calls using the fax machine's handset or an extension phone connected to the same line.

### Answering with the fax's handset

- 1 Pick up the handset when the machine rings.

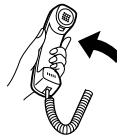

- 2 If you hear a fax tone, wait until the display shows RECEIVING and then replace the handset.

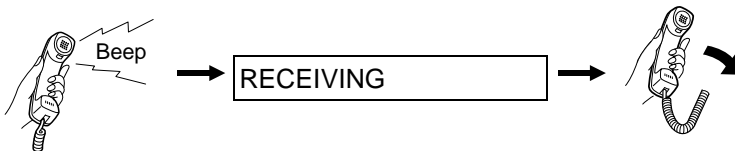

**Note:** If you have set Option Setting 12 (Fax signal receive) to NO, press the **START/MEMORY** key to begin reception.

- 
- 3** If the other party first talks and then wants to send a fax, press the **START/MEMORY** key after speaking (press your **START/MEMORY** key before the sender presses their Start key).
- Make sure that the display shows **RECEIVING**, then replace the handset.

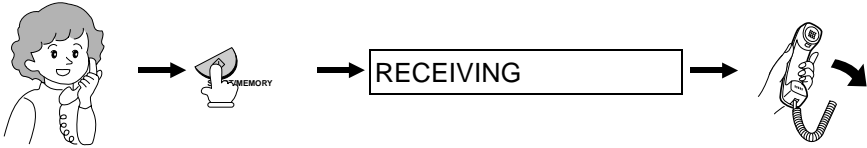

---

### Answering with an extension phone

- 1** Answer the extension phone when it rings.

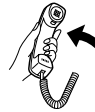

- 
- 2** If you hear a soft fax tone, wait until your fax responds (the extension phone will go dead if it is connected to your fax, or you will hear pronounced, high-pitched tones if the phone is connected to a separate wall jack), then hang up.

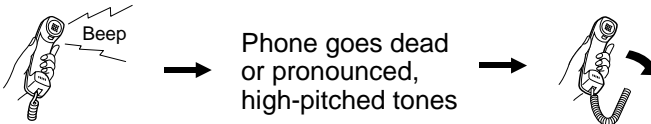

- 
- 3** If the fax doesn't respond, or if the other party first talks to you and then wants to send a fax, press **5**, **\***, and **\*** on the extension phone (only on a tone dial phone). This signals the fax to begin reception. Hang up.

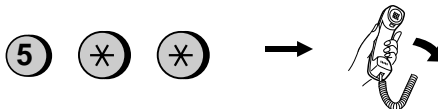

**Comments:**

- Your fax will not accept the signal to begin reception (5\* \*) if a document is loaded in its feeder.
- If you have set Option Setting 12 to NO and hear a fax tone when you answer the extension phone, you must press 5, \*, and \* if you are on a touch-tone phone, or walk over to the fax, pick up the handset, and press the **START/MEMORY** key if you are on a pulse dial phone.
- The code used to activate fax reception from a touch-tone extension phone (5\* \*) can be changed if desired. See Option Setting 5 (Tel/Fax Remote Number) in Chapter 8, *Option Settings*.

**2 in 1 Print**

To save paper, you can have the size of your incoming faxes reduced by 55%. This will allow you to receive, for example, a 2-page document on one page (note that this may not be possible if the document pages are longer than your printing paper). To turn on this function, follow the steps below.

**1** Press these keys:



The display will show:

**2** Press **1** to turn on the function, or **2** to turn it off.

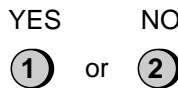

The display will show:

**3** Press the **STOP** key.



## Reception Ratio

The fax has been set at the factory to automatically reduce the size of received documents to fit the size of the printing paper. This ensures that data on the edges of the document are not cut off. If desired, you can turn this function off and have received documents printed at full size.

**Note:** If a document is too long to fit on the printing paper, the remainder will be printed on a second page. In this case, the cut-off point may occur in the middle of a line.

**Note:** Automatic reduction may not be possible if the received document is too large, contains too many fine graphics or images, or is sent at high resolution. In this case, the remainder of the document will be printed on a second page.

---

**1** Press these keys:



The display will show: RECEPTION RATIO

---

**2** Press **1** to turn automatic reduction on, or **2** to turn it off.

AUTO      100%

**1**   or   **2**

If you selected AUTO, go to Step 3. If you selected 100%, go to Step 4.

---

**3** If you selected AUTO, select the reception ratio to be used in the event that the memory becomes full (automatic reduction is not possible when the memory is full). Press **1** for 93% or **2** for 100%.

93%      100%

**1**   or   **2**



**4** Press the **STOP** key.



## ***Substitute Reception to Memory***

In situations where printing is not possible, such as when your fax runs out of paper, the imaging film needs replacement, or the paper jams, incoming faxes will be received to memory.

When you have received a document in memory, FAX RX IN MEMORY will appear in the display, alternating with OUT OF PAPER, FILM END, or PAPER JAM. When you add paper, replace the imaging film, or clear the jam, the stored documents will automatically print out.

- ◆ If you received documents in memory because the fax ran out of paper, be sure to add paper which is the same size as the paper previously used. If not, the document print-out size may not match the size of the printing paper.

### **Caution!**

- When documents are stored in memory, do not turn the power off. This will erase all of the contents.
- If documents received in memory are lost due to a power failure or other interruption in the power supply, a CLEAR REPORT will be printed out when the power is restored. This gives information about the receptions lost, including the fax numbers of the transmitting machines if they are available.

# Making Copies

Your fax can also be used to make copies. Single and multiple copies (up to 99 per original) can be made, enabling your fax to double as a convenience office copier.

- 1 Load the document(s) face down.  
(Maximum of 10 pages.)

The display will show:

READY TO SEND

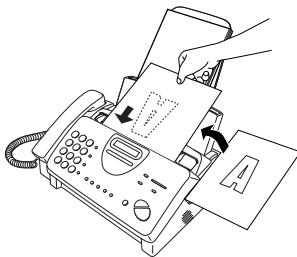

- Set the resolution and/or contrast if desired. (The default setting for copying is SUPER FINE.)

RESOLUTION



- 2 Press the **COPY/HELP** key.

The display will show:

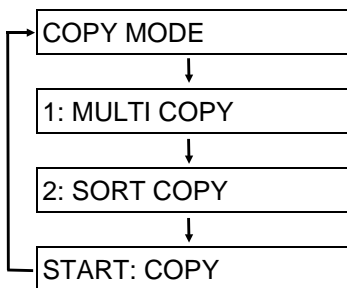

COPY/HELP

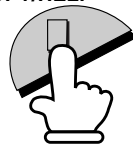

- ◆ If you are only making one copy of the original (or of each original) and don't want to make a reduction or enlargement setting, press the **START/MEMORY** key twice. Copying will begin.
- ◆ If you are only making one copy of the original (or of each original) and want to make an enlargement or reduction setting, press the **START/MEMORY** key and go to Step 5.

- 3** Press **1** (MULTI COPY) if you do not want the copies sorted. Press **2** (SORT COPY) if you want the copies sorted.

MULTI **1** or SORT **2**

Example of three copies each of three originals

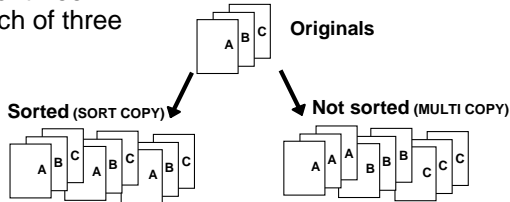

The display will show:

- 4** If you are making one copy per original, press the **START/MEMORY** key. If you are making multiple copies per original, enter the number of copies per original (if the number is less than 10, enter a "0" before the number).

**0** **9**

Example: Nine copies per original

The display will show:

- 5** Set the amount of reduction or enlargement by entering a number from **1** to **5** as shown below (or press the **START/MEMORY** key to automatically select 100%). Copying will begin.
- 1:** AUTO (automatic size adjustment to match the size of the printing paper)
  - 2:** 50%
  - 3:** 100% (no reduction or enlargement)
  - 4:** 125%
  - 5:** 135%

**2**

Example: 50%

**Note:** If you place a large number of originals in the feeder, the memory may become full before all of them can be scanned (MEMORY IS FULL will appear in the display). If this happens, press the **START/MEMORY** key to copy the originals which have been scanned, and then repeat the copy procedure for the remaining originals, including the original which was being scanned when the memory became full.

### **Copy Cut-off**

When making a copy of a document that is longer than the printing paper, use the copy cut-off setting to select whether the remaining part of the document will be cut off or printed on a second page. The initial setting is YES (cut off the remainder). To change the setting, follow the steps below.

- 
- 1** Press these keys:

FUNCTION



The display will show:

COPY CUT-OFF

- 
- 2** Press **1** to set copy cut-off to YES (the remaining part of the document will not be printed), or **2** to set copy cut-off to NO (the remaining part will be printed on a second page).

YES



or

NO



The display will show:

INITIALIZE FILM

- 
- 3** Press the **STOP** key to return to the date and time display.

STOP



## Making Telephone Calls

Your fax can be used like a regular telephone to make and receive voice calls.

- ◆ To make or receive a phone call, the power must be on.

- 1** Pick up the handset or press the **SPEAKER** key. Listen for the dial tone.

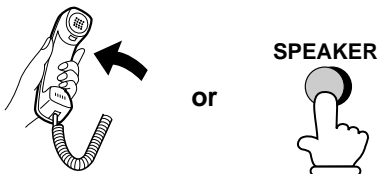

- 2** Dial the number using one of the following methods:

- **Normal Dialing:** Enter the full telephone number with the numeric keys.
- **Rapid Key Dialing:** Press the appropriate Rapid Key.
- **Speed Dialing:** Press the **SPEED DIAL** key, and enter the 2-digit Speed Dial number with the numeric keys.

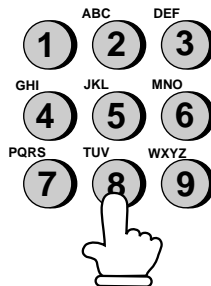

- 3** Speak with the other party when they answer.
  - If you pressed the **SPEAKER** key, pick up the handset to talk.

### Comments:

- While the handset of the fax is lifted (off hook), an extension phone connected directly to the fax cannot be used to speak with the other party.
- The fax may interrupt a voice call received on an extension phone if the reception mode is set to A.M. and there is a period of silence during the conversation. If you are on a touch-tone phone, you can prevent this by pressing any three keys on the phone immediately after you answer. (Note: Do not enter the code to activate fax reception: 5, \* , \* .)

### **Chain Dialing**

After lifting the handset, you can dial any combination of Normal Dialing, Rapid Key Dialing and Speed Dialing numbers. For example, if you have stored an area code or an access code for a special service in a Rapid Key, you can press the Rapid Key for that area code or access code, then dial the remainder of the number by pressing a Rapid Key, pressing number keys, or pressing the **SPEED DIAL** key and entering a two-digit Speed Dial number.

### **Using the HOLD/SEARCH key**

You can use the **HOLD/SEARCH** key to search for a Rapid Key or Speed Dial number. First search for the number as described in *Using the HOLD/SEARCH key in Sending a Fax by Automatic Dialing* in Chapter 2, then pick up the handset or press the **SPEAKER** key. The number will be dialed automatically (do not press the **START/MEMORY** key).

### **Redial**

The last number called can be redialed by pressing the **REDIAL** key (it is not necessary to pick up the handset or press the **SPEAKER** key). When the other party answers, pick up the handset to talk.

## ***Hold***

You can put the other party on hold during a conversation by pressing the **HOLD/SEARCH** key. When this is done, they cannot hear you. You can put the handset back in the cradle without breaking the connection. When you are ready to speak with them again, pick up the handset. If you did not put the handset back in the cradle, press the **HOLD/SEARCH** key again to resume conversation.

# Answering Machine Hookup

## Connecting an Answering Machine

If desired, you can connect an answering machine to your fax machine's **TEL. SET** jack. This will allow you to receive both voice messages and faxes when you are out.

- 1 Remove the seal covering the **TEL. SET** jack.

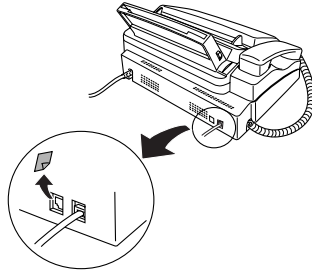

- 2 Connect the answering machine's telephone line jack to the **TEL. SET** jack.

- If desired, you can connect an extension phone to your answering machine's extension phone jack.

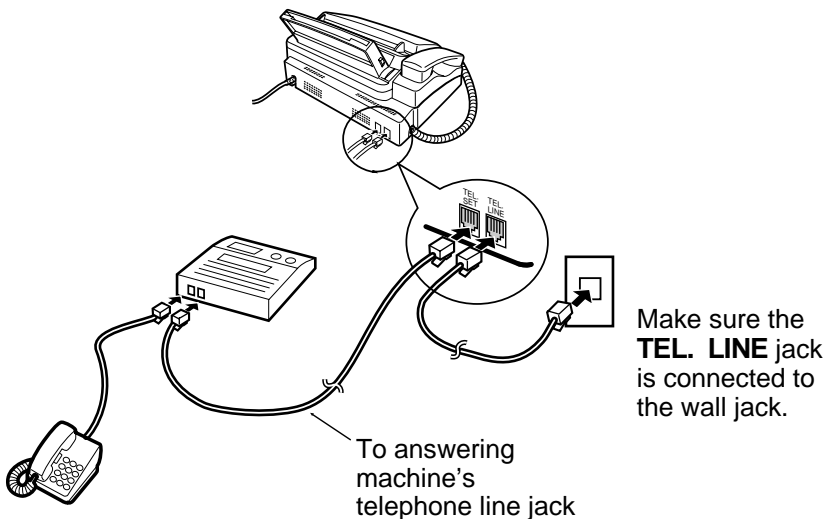



## Changing the outgoing message

The outgoing message (OGM) of your answering machine should be changed to inform callers who want to send a fax to press their Start key. For example, your message might go as follows:

"Hello. You've reached the ABC company. No one is available to take your call right now. Please leave a message after the beep or press your facsimile Start key to send a fax. Thank you for calling."

### Comments:

- Try to keep the length of the message under 10 seconds. If it is too long, you may have difficulty receiving faxes sent by automatic dialing.
- If your outgoing message must be longer than 10 seconds, leave a pause of about four seconds at the beginning of the message. This will give your fax a chance to detect fax tones sent when automatic dialing is used.

## Activating the Answering Machine Hookup

Before you go out, activate the answering machine hookup as follows:

- 1 Set the reception mode to A.M.

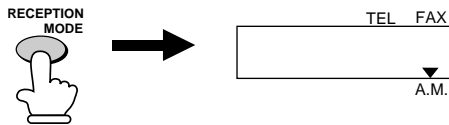

- 2 Set your answering machine to auto answer.

- Your answering machine must be set to answer on a maximum of two rings. If not, you may not be able to receive faxes sent by automatic dialing.
- If your answering machine has a toll saver function, make sure that it will answer by the fourth ring.

### ***How the hookup operates***

While you are out, all of your incoming calls will be answered by your answering machine and its outgoing message will play. Voice callers can leave a message. During this time, your fax will quietly monitor the line. If your fax detects a fax tone or a duration of silence greater than four seconds, it will take over the line and begin reception.

When you return and turn off your answering machine, be sure to change the reception mode back to FAX or TEL!

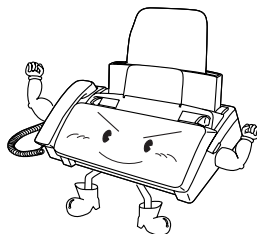

## Caller ID

If you subscribe to a caller identification service from your telephone company, you can set your fax to display the name and number of the caller while the fax rings.

### Important:

- To use this function, you must subscribe to a caller identification service from your telephone company.
- Your fax may not be compatible with some caller identification services.

**1** Press these keys:

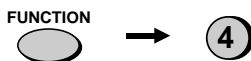

The display will show:

**2** Press the \* key three times.



The display will show:

**3** Press **1** to turn on Caller ID, or **2** to turn it off. (If you selected **2** (NO), go to Step 7.)

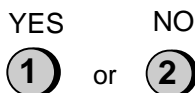

If you selected **1** (YES), the display will show:

- 4** Press **1** to select SET. (To clear a previously programmed area code, press **2** and go to Step 7.)

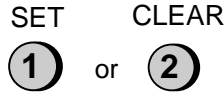

The display will show:

- 5** Enter the three digits of your area code.



(Example)

- 6** Press the **START/MEMORY** key to store your area code.



The display will show:

- 7** Press the **STOP** key to return to the date and time display.



- Set Option Setting 2 (Number of Rings to Answer) to 2 or more rings (see Chapter 8).

### ***How Caller ID operates***

When you receive a call, the name and phone number of the caller will alternately appear in the display, beginning just before the second ring. The information will continue to be displayed until you pick up the handset, or until the fax answers automatically if it is in FAX mode.

**Note:** Some caller ID services may not provide the name of the caller. In this case, only the phone number will appear.

Display example:

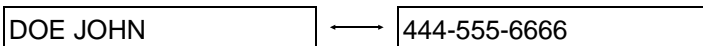

Caller's name

Caller's number

## Display messages

One of the following messages will appear while the fax rings if caller information is not available.

- NO SERVICE** No caller information was received from your telephone company. Make sure that the telephone company has activated your service.
- CALLER-ID ERROR** Noise on the telephone line prevented reception of caller information.
- OUT OF AREA** The call was made from an area which does not have a caller identification service, or the caller's service is not compatible with that of your local phone company.
- PRIVATE CALL** Caller information was not provided by the telephone company at the caller's request.

## Viewing the Caller ID list

If you subscribe to a Caller ID service and have turned on the Caller ID function, your fax machine will keep information on the most recent 20 calls and faxes you have received. You can view this information, which consists of the name and number of each caller, in the Caller ID List.

- ◆ After you have received 20 calls, each new call will delete the oldest call.

Follow the steps below to view the Caller ID List in the display. If desired, you can immediately dial a number when it appears.

To print out the list, see Chapter 9, *Printing Reports and Lists*.

**1** Press these keys:

HOLD/SEARCH



**2**

The display will show: REVIEWING CALLS

- 2** Press the \* key to scroll through the list from the most recent call, or the # key to scroll through the list from the oldest call.



- 3** If you want to dial one of the numbers in the list, scroll through the list until the number appears in the display.



- If you want to send a fax, load the document and then press the **START/MEMORY** key.
- If you want to make a voice call, pick up the handset or press the **SPEAKER** key. Dialing will begin automatically. (If you pressed the **SPEAKER** key, pick up the handset when the other party answers.)

- 4** Press the **STOP** key when you have finished viewing the list.



### ***To delete calls from the Caller ID list***

If you want to delete a single call from the caller list, press the **0** key while the call appears in the display. If you want to delete all calls from the list, hold the **0** key down for at least 3 seconds while you are viewing any number in the list.

### ***Priority Call***

If desired, you can set your fax to make a special ringing sound when you receive a call from a designated phone number. This lets you know immediately who is calling without having to look at the display. To use this function, enter the desired phone number by following the steps below (only one phone number can be entered).

- 1** Press the keys shown at right. PRIORITY CALL # will appear in the display.



- 2** Press **1** to enter a number, or **2** to clear a number. (If you pressed **2**, go to Step 4.)

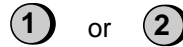

- 3** Enter the phone number, including the area code, by pressing the number keys (max. of 20 digits).



(Example)

- 4** Press the **START/MEMORY** key and then the **STOP** key.



## Blocking voice calls

With Caller ID turned on, you can use the Anti Junk Fax function described in *Blocking Reception of Unwanted Faxes* in this chapter to block voice calls as well as fax receptions (the Anti Junk Fax function normally only blocks faxes).

In this case, when a voice call or a fax transmission comes in from a number you have specified as a "Junk Number", your fax will break the connection as soon as it receives the calling phone number from the caller ID service (before the second ring).

To use this function, set Option Setting 13 to YES as described in Chapter 8, *Option Settings*, and then enter the number in the Anti Junk Number List as explained in *Blocking Reception of Unwanted Faxes* in this chapter.

**Note:** This function cannot be used if you are using the Distinctive Ring function.

## ***Distinctive Ring***

### **Important:**

- **To use distinctive ring, you must subscribe to a distinctive ring service from your local phone company. Do not turn on this function if you do not subscribe to a distinctive ring service.**
- Your fax may not be compatible with some distinctive ring services.

Distinctive ring is a service offered by some local telephone companies whereby they assign an additional second number to your regular single line. The second number rings differently from your normal number.

If you subscribe to a distinctive ring service, you can set the fax machine to automatically answer when your second number is called. This allows you to use the second number as an exclusive fax number.

To have your fax automatically answer when your second number is called, follow the steps below:

---

**1** Press these keys:



The display will show:

---

**2** Press these keys:



The display will show:



**3** Press a number from **1** to **3** to select the ring pattern below that matches your second number's ring pattern. Or, press **4** to have your fax automatically answer your normal telephone number. Press **5** to turn off the distinctive ring function.

- 1** RING PATTERN 1: Two short rings.
- 2** RING PATTERN 2: One short, one long, and one short ring.
- 3** RING PATTERN 3: Two short rings and one long ring.
- 4** STANDARD RING: Your standard (normal) ring pattern.
- 5** OFF SETTING: Turn distinctive ring off.

The display will show:

FAX SIGNAL RX

**4** Press the **STOP** key.



**5** Set the reception mode to FAX.

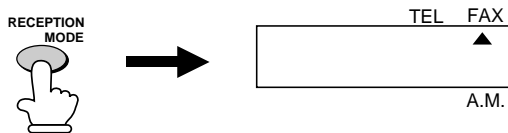

When using distinctive ring, you must set the reception mode of your fax to FAX. When your designated fax number is dialed, your fax will automatically answer and begin reception after two rings. Note that other devices on the same line will also ring until your fax answers. If one of your other numbers is dialed, the fax will ring; however, it will not answer.

**Note:** If you are using an answering machine with your distinctive ring service, the answering machine must be connected to a separate wall jack. Do not connect it directly to your fax.

## Broadcasting

This function allows you to send the same document to as many as 20 different locations with just one operation. First store the document in memory, then enter the numbers of the receiving machines. The document will be transmitted to each location.

- ◆ You can only use Rapid Keys or Speed Dial numbers to dial the numbers of the receiving machines.

---

### 1 Load the document(s).

The display will show:

READY TO SEND

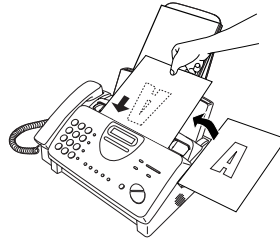

---

### 2 Press the **START/MEMORY** key and then 2.



---

### 3 Dial the receiving machines (maximum of 20) using one or both of the following methods:

- Enter one or more Speed Dial numbers by pressing the number keys.
- Press one or more Rapid Keys.

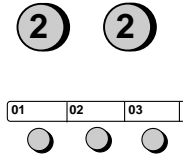

(Example)

---

### 4 Press the **START/MEMORY** key.

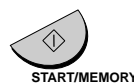

- Set the resolution and/or contrast if desired.



---

**5** Press the **START/MEMORY** key.  
Transmission will begin.

- A Transaction Report is automatically printed out after Broadcasting is completed. Check the "Note" column of the report to see if any of the locations are marked "Busy" or have a communication error code. If so, send the document to those locations again.

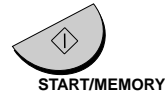

## Cover Sheet

You can have the fax generate a cover sheet and send it as the last page of each of your fax transmissions.

You can select a message.

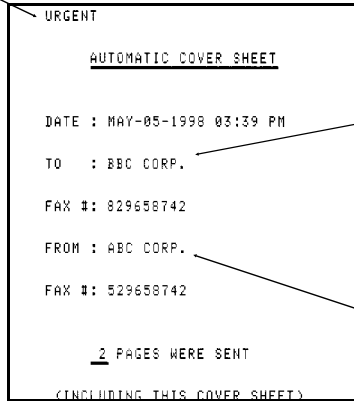

For the recipient's name to appear, you must dial using a Speed Dial or Rapid Key number with the name programmed.

Your name and number must be programmed as explained in Chapter 1.

Follow the steps below to turn on the cover sheet function. Once the cover sheet function is turned on, cover sheets will be included with all transmissions until you turn it off.

**1** Press these keys:



The display will show:



**2** Press these keys:



The display will show:

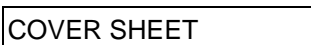

- 3** Press **1** (YES) to turn on the cover sheet function, or **2** (NO) to turn it off.

YES

NO

The display will show:

**1**

or

**2**

AUTO PRINT OUT

- 4** Press the **STOP** key to return to the date and time display.

STOP



### Selecting a header message (optional)

When the cover sheet function is turned on, you can also select a message which will appear as a header at the top of the cover sheet. Note that the message selection is only effective for one transmission.

- 1** Load the document(s).
- The document must be loaded before a message can be selected.
  - The cover sheet function must be turned on.

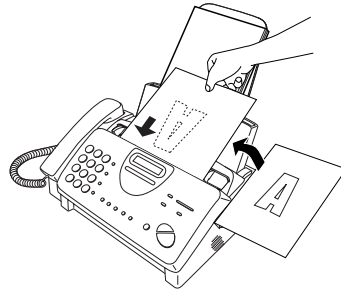

- 2** Press these keys:

FUNCTION

**5**

The display will show:

COVER SHEET HEAD

**3** Select a message by entering a number

from **1** to **4**:

**1**: URGENT

**2**: IMPORTANT

**3**: CONFIDENTIAL

**4**: PLS. DISTRIBUTE



(Example)

---

**4** Dial the receiving machine and transmit the document.

**Note:** To cancel a cover sheet header setting, press the **STOP** key or remove the document from the feeder.

## Batch Page Numbering

You can change the page numbering of the transmitted document from simple numbering ("P.01", "P.02", etc.) to batch numbering, which means that a slash and the total number of pages being sent are added after each page number (for example, "P. 01/05", "P.02/05", etc.). This allows the receiver to check for missing pages.

### 1 Load the document(s).

- The document must be loaded before batch page numbering can be set.

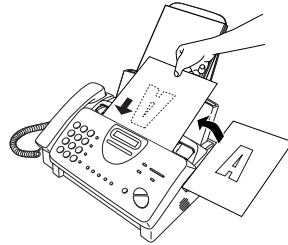

### 2 Press these keys:

The display will show:

PAGE COUNTER SET

FUNCTION



### 3 Enter the total number of pages ("01" to "99") by pressing the number keys.

- If you are sending a cover sheet, **do not** include it in the total number of pages (the number will be adjusted automatically).



Example:  
Eight pages

### 4 Dial the receiving machine and transmit the document.

### Comments:

- If you need to cancel a batch number entry, remove the document from the feeder or press the **STOP** key.
- If the number of pages actually transmitted does not coincide with the batch number entered, the alarm will sound and PAGE COUNT ERROR will appear in the display. PAGE E. will also appear in the NOTE column of the Transaction Report if it has been set to print out.



## Blocking Reception of Unwanted Faxes

The Anti Junk Fax function allows you to block reception of faxes from parties which you specify. This saves paper by not printing out unwanted "junk" faxes.

To use this function, first turn it on by setting Option Setting 13 to YES as explained in Chapter 8, and then enter the fax numbers from which you do not want to receive faxes as shown below. If you are using the Caller ID function, you can also enter voice numbers.

### Comments:

- Up to 5 numbers can be entered in the Anti Junk Number List.
- The Anti Junk function will not operate for a number which has also been stored as a Priority Call number.
- To clear a number from the Anti Junk Number List, you need to know the 1-digit number which identifies it. If you have forgotten this number, print out the Anti Junk Number List as explained in Chapter 9.

- 
- 1** Press the keys shown at right.  
STORE JUNK # will appear in the display.



- 
- 2** Press **1** to store a number in the Anti Junk Number List, or **2** to clear a number from the list.

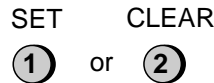

- 
- 3** **Storing:** Enter a 1-digit number from 1 to 5. This number identifies the fax/voice number you will store in the next step.



(Example)

**Clearing:** Enter the number which identifies the fax/voice number you want to clear, and go to Step 5.

---

## Blocking Reception of Unwanted Faxes

---

- 4** Enter the full number you want to block (max. of 20 digits).



(Example)

- 
- 5** Press the **START/MEMORY** key.



- 
- 6** Return to Step 3 to enter (or clear) another number, or press **STOP** to exit.

**Step 3 or**



## ***Sending Documents From Memory***

With this function, the original document is scanned immediately, stored in memory, and then transmitted once the connection to the receiving machine is made. This is convenient when transmitting to places where the line is often busy, as it saves you from waiting to pick up the original document and frees the feeder for other operations. After transmission, the document will be cleared from memory.

- ◆ Only one memory transmission can be set at a time.
- ◆ The amount of memory currently occupied appears as a percentage in the display while the document is being scanned.

### **1** Load the document(s).

The display will show:

READY TO SEND

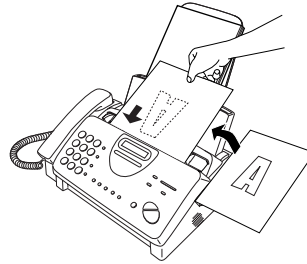

- Set the resolution and/or contrast if desired.



### **2** Press the **START/MEMORY** key and then **1**.



The display will show:

ENTER STATION #

**3** Enter the number of the receiving machine using one of the following methods:

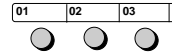

(Example)

- Press a Rapid Key.
- Press the **SPEED DIAL** key and enter a Speed Dial number.
- Enter a full telephone number by pressing the number keys.

---

**4** Press the **START/MEMORY** key if you entered a Speed Dial number or a full number.



- The document will be scanned and stored in memory. Your fax will then dial the receiving machine and transmit the document (redialling will be done automatically if necessary).

***If the memory becomes full...***

If the memory becomes full while the document is being scanned, MEMORY IS FULL will appear in the display.

- ◆ Press the **START/MEMORY** key if you want to transmit the pages which have been stored up to that point in memory. The remaining pages will be ejected from the feeder. After transmission, the memory will be cleared and you can transmit the remaining pages. You will also need to transmit the page which was being scanned when the memory filled up.
- ◆ Press the **STOP** key if you want to cancel the entire transmission.

## Polling (Requesting a Fax Transmission)

Polling allows you to call another fax machine and have it send a document (previously loaded in its feeder) to your machine without operator assistance. In other words, the receiving fax machine, not the transmitting fax machine, initiates the transmission. You can use your machine to both poll and be polled by others.

To use the polling function, you must first set Rapid Key 05/POLL for use as a polling key. This is done by changing Option Setting 14, as described in Chapter 8, *Option Settings*.

### Requesting transmission

**Note:** Rapid Dial Keys cannot be used for polling. To dial a Rapid Dial location, press the **SPEED DIAL** key and then enter the 2-digit number corresponding to the Rapid Key.

**1** Dial the fax machine you want to poll using one of the following methods:

- Pick up the handset (or press the **SPEAKER** key) and dial the full number. Wait for the fax answerback tone.
- Press the **SPEED DIAL** key and enter a 2-digit Speed Dial number.
- Enter the full number using the numeric keys.

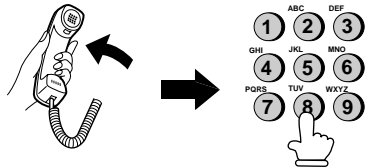

(Example)

**2** Press Rapid Key 05/POLL.

- If you used the handset, replace it when POLLING appears in the display. Reception will begin.

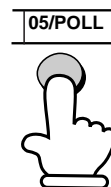

### ***Being polled (polling standby)***

To let another fax machine poll your machine, simply set the reception mode to FAX, and load the document(s) to be sent.

Transmission will take place when the other fax machine calls your machine and activates polling. Automatic reception is possible while your machine is on polling standby.

### ***Polling security***

Polling Security allows you to prevent unauthorized polling of your machine. When this function is turned on, polling will only take place when the fax number of the polling fax machine has been entered in your machine's list of permitted fax numbers (called "passcode numbers"). The number of the polling fax must also be programmed in itself for identification.

To use Polling Security, follow the steps below to turn the function on, and then enter permitted numbers as shown on the following page.

- 
- 1** Press the keys shown at right.  
ENTRY MODE will appear in the display.

FUNCTION



- 
- 2** Press the # key three times.  
SECURITY SELECT will appear in the display.



- 
- 3** Press **1** to turn polling security on, or **2** to turn it off.



or



- 
- 4** Press the **START/MEMORY** key and then the **STOP** key.



## Storing and clearing fax numbers for polling permission

You can store up to 10 fax numbers in your machine's list of permitted numbers.

- 1** Press the keys shown at right.  
ENTRY MODE will appear in the display.



- 2** Press the # key four times.  
PASSCODE # MODE will appear in the display.



- 3** Press **1** to store a number, or **2** to clear a number.

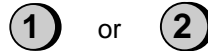

- 4 Storing:** Enter a 2-digit number from 01 to 10. This number identifies the fax number you will store in the next step.



(Example)

**Clearing:** Enter the number which identifies the fax number you want to clear, and go to Step 6.

- 5** Enter the fax number (max. of 20 digits).



(Example)

- 6** Press the **START/MEMORY** key.



- 7** Return to Step 4 to enter (or clear) another number, or press **STOP** to exit.

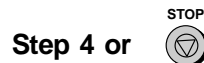













## Timer Operations

The Timer function allows you to set a transmission and/or polling operation to be performed automatically at a time you specify. One transmission operation and one polling operation can be set at any one time, and the times they will be performed can be specified up to 24 hours in advance.

As an example, you can use this function to take advantage of lower nighttime telephone rates without having to be there when the operation is performed.

**Note:** Only a Speed Dial number can be used to dial the receiving machine.

### Setting a timer operation

- 
- 1** Press the keys shown at right. **TIMER MODE** will appear in the display.
-  
- 
- 2** Press # to set a transmission operation (**SEND MODE**), or \* to set a polling operation (**POLLING MODE**).
-  or 
- 
- 3** Press **1** to select **SET**.
- 
- 
- 4** Enter the time at which you want the operation to take place (2 digits for the hour and 2 digits for the minute).
-    
- Example: 9:25
- 
- 5** Press the \* key to select **A.M.** or the # key to select **P.M.**
-  or 
- 
- 6** Press the **START/MEMORY** key.
- 



**7** Enter the Speed Dial number of the receiving fax machine.



- If this is a polling operation, go to Step 10.

(Example)

**8** Press the **START/MEMORY** key.



**9** Adjust the resolution and/or contrast if desired (skip to the next step if you don't want to change settings).



**10** Press the **START/MEMORY** key and then the **STOP** key. If this is a transmission operation, load the document in the feeder sometime before the specified time of transmission.



### To cancel an operation

If you need to cancel an operation after it has been set, follow the steps below.

**1** Press the keys shown at right. **TIMER MODE** will appear in the display.



**2** Press # to cancel a transmission operation, or \* to cancel a polling operation.



or



**3** Press 2 to select CLEAR.



**4** Press the **START/MEMORY** key and then the **STOP** key.



# Option Settings

The option settings let you customize your fax to better suit your needs. An initial setting has been made for each option at the factory. You can change a setting by following the steps described for each option below.

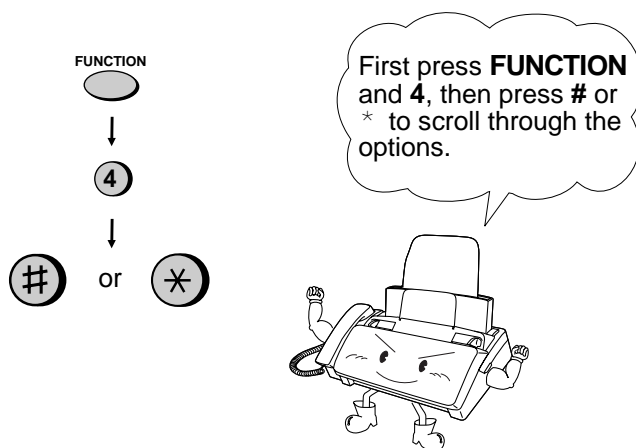

## Setting 1: FINE RESOLUTION PRIORITY

This option sets the default resolution (the resolution used if a setting is not made with the **RESOLUTION** key) for transmitting documents. Press **1** (YES) to set the default resolution to FINE, or **2** (NO) to set it to STANDARD.

- Initial setting: 2

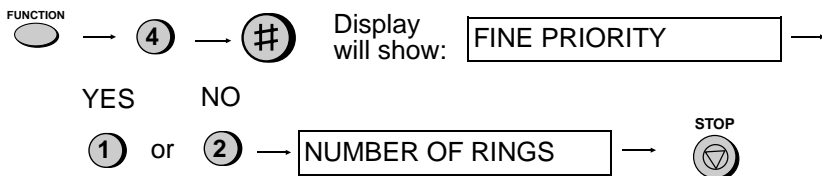

**Setting 2: NUMBER OF RINGS TO ANSWER**

This option sets the number of rings the fax machine waits before answering an incoming call in FAX reception mode. Enter any number from **1** to **5** rings.

- Initial setting: **4**

**Setting 3: RECALL INTERVAL**

This sets the amount of time your fax will wait between automatic redials when the line is busy. Enter **01** for 1 minute, **02** for 2 minutes, etc., up to a maximum of **15** minutes.

- Initial setting: **05**

**Setting 4: RECALL TIMES**

This sets the maximum number of times your fax will automatically redial if the line is busy. Enter any number from **00** to **10**.

- Initial setting: **02**

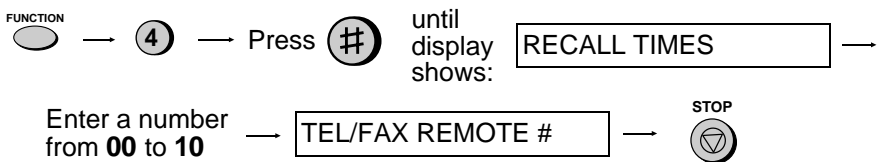

### Setting 5: TEL/FAX REMOTE NUMBER

If you hear a fax tone when you answer a call on a touch-tone extension phone connected to the same line as the fax, you can make the fax begin reception by pressing **5**, **\***, and **\*** on the phone. Use this setting if you want to use a number other than **5** to begin fax reception. You can enter any number from **0** to **9**.

- Initial setting: **5**

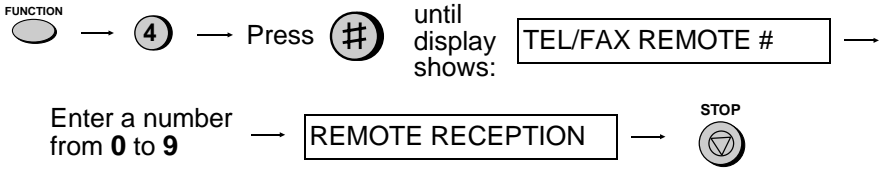

### Setting 6: REMOTE RECEPTION SELECT

If you don't intend to use the above TEL/FAX REMOTE NUMBER, you can turn detection of the number off. This will ensure that the fax never mistakenly attempts to begin reception if it detects a signal similar to the TEL/FAX REMOTE NUMBER while you are talking on an extension phone. Press **1** to turn detection on, or **2** to turn detection off.

- Initial setting: **1**

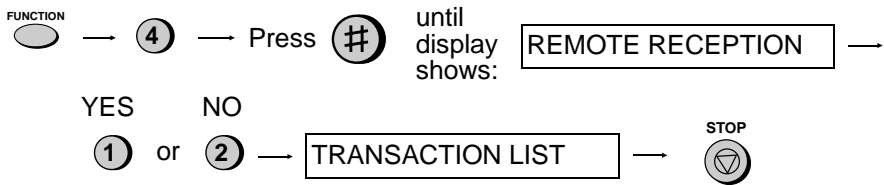

**Setting 7: TRANSACTION REPORT PRINT SELECT**

This sets the condition for printing out a Transaction Report. Enter a number from **1** to **5** as follows:

- 1 (ALWAYS PRINT):** A report will be printed after each transmission, reception, or error.
- 2 (ERR/TIMER/MEM):** A report will be printed after an error, timer operation, or memory operation.
- 3 (SEND ONLY):** A report will be printed only after a transmission.
- 4 (NEVER PRINT):** A report will never be printed.
- 5 (ERROR ONLY):** A report will be printed only after an error occurs.

- Initial setting: **5**

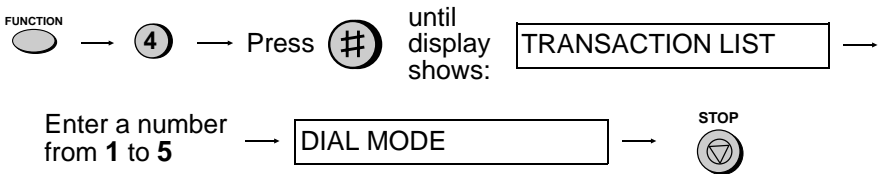
**Setting 8: DIAL MODE**

This sets the mode of dialing. Press **1** if you are on a touch-tone line, or **2** if you are on a pulse dial line. (If you don't know which type of line you have, try making phone calls with both settings and see which one works.)

- Initial setting: **1**

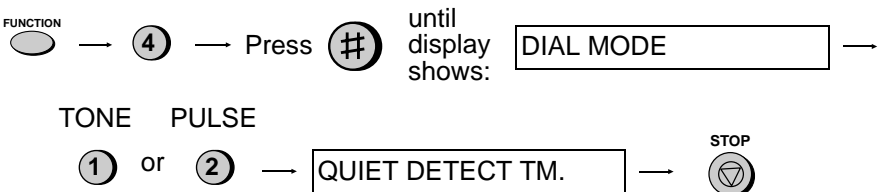

### Setting 9: QUIET DETECT TIME

When an answering machine is connected to the fax, the fax will take over the line and begin reception if it detects a certain duration of silence after the answering machine answers a call. This sets the duration of silence (in seconds). Enter a number from **01** to **10**, or enter **00** to turn off the function.

(Note: We recommend that you do not set Quiet Detect Time below 3 seconds.)

- Initial setting: **04**

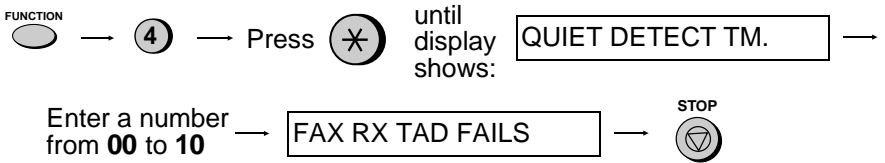

### Setting 10: FAX RECEPTION WHEN TAD FAILS

Press **1** (YES) to have the fax answer a call if an answering machine connected to the fax does not answer within 5 rings. Press **2** (NO) to turn the function off.

- Initial setting: **2**

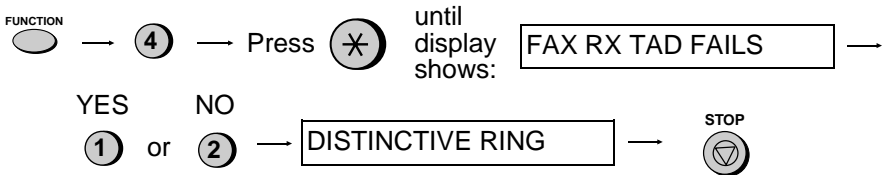

**Setting 11: DISTINCTIVE RING**

This sets the ring pattern to which your fax will answer if you subscribe to a distinctive ring service. Enter a number from **1** to **5** to select a pattern. See *Distinctive Ring* in Chapter 7 for more details.

- Initial setting: **5**

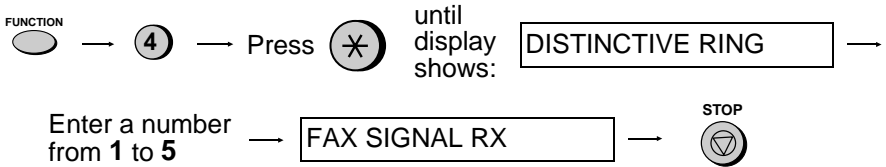
**Setting 12: FAX SIGNAL RECEIVE**

Your fax will automatically begin reception if you hear a high-pitched fax tone after answering a call on your fax or an extension phone. If you use a computer fax modem to send documents on the same line, you must turn this function off in order to prevent your fax from mistakenly attempting to receive documents from the computer fax modem. Press **1** to turn the function on, or **2** to turn it off.

- Initial setting: **1**

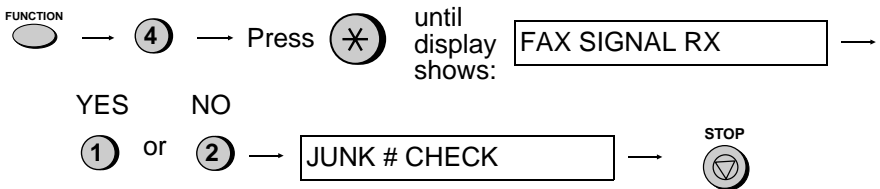
**Setting 13: JUNK FAX NUMBER CHECK**

Press **1** to prevent reception from fax numbers entered in the Anti Junk Fax List. Press **2** to allow reception from all numbers.

- Initial setting: **2**

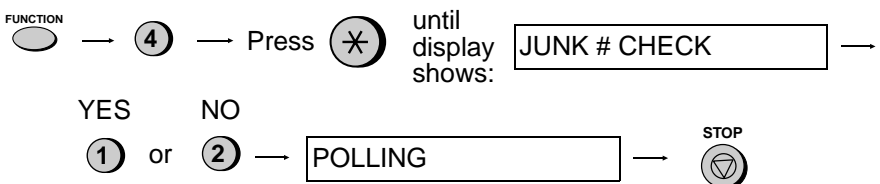

### Setting 14: POLLING

Press **1** if you want to use Rapid Key 05/POLL as a polling key. Press **2** if you want to use it as a regular Rapid Key.

- Initial setting: **2**

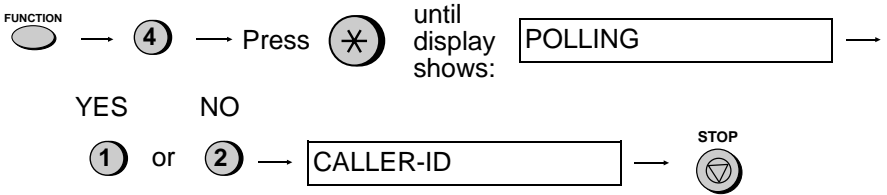

### Setting 15: CALLER ID

If you subscribe to a caller ID service and want to use the Caller ID function, press **1** twice, enter your 3-digit area code by pressing the number keys, and then press the **START/MEMORY** key. To turn Caller ID off, press **2**. (Caller ID is explained in more detail in *Caller ID* in Chapter 7.)

- Initial setting: **2**

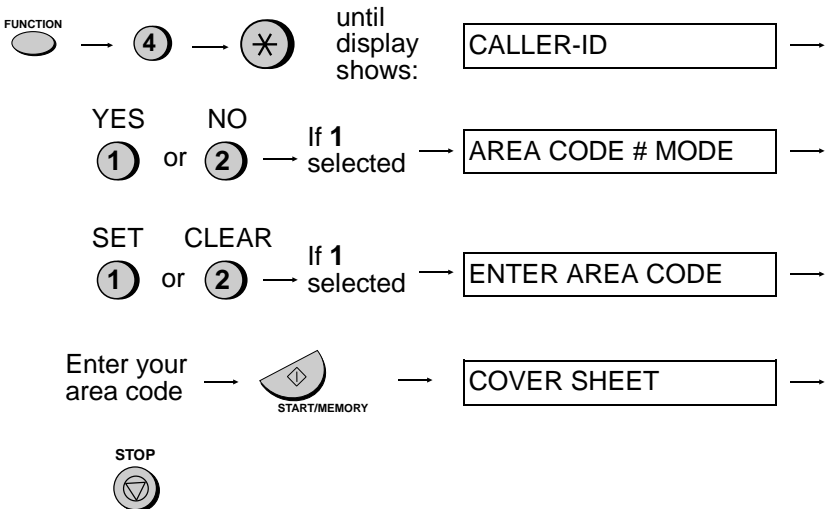



**Setting 16: AUTO COVER SHEET**

Press **1** (YES) to have the fax automatically generate a cover sheet and send it as the last page of each transmission. Press **2** (NO) to turn the function off.

- Initial setting: **2**

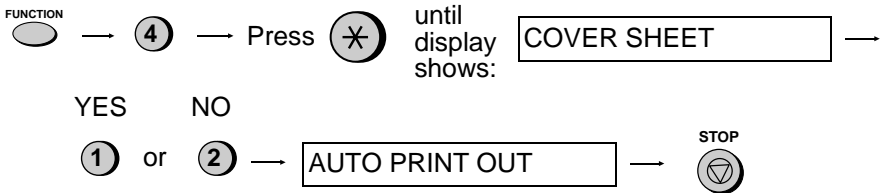
**Setting 17: ACTIVITY REPORT AUTO PRINT OUT**

Press **1** to have your fax automatically print out an Activity Report once every 30 operations. (The list can still be printed out on demand when desired.) Press **2** to turn automatic print-out off.

- Initial setting: **2**

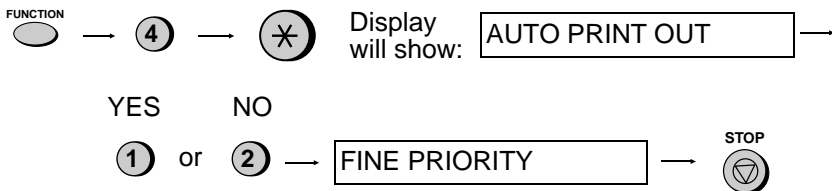

# Printing Reports and Lists

You can print out lists showing settings and information entered in the fax. You can also have the fax automatically print out a report on transactions after they are made. The lists and the report are described below.

## Printing a list

- 1 Press these keys:

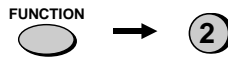

The display will show: LISTING MODE

- 2 Press the # key or the \* key until the desired list appears in the display.

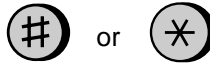

- 3 Press the **START/MEMORY** key.

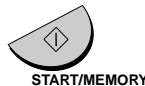

## Activity Report

This report shows information on your most recently performed send and receive operations (a combined maximum of 30 operations can appear). The report is divided into two parts: the **TRANSMISSIONS ACTIVITY REPORT**, which shows information on transmissions, and the **RECEPTIONS ACTIVITY REPORT**, which shows information on receptions.

- ◆ If Option Setting 17 (Auto Print Out) is set to YES, a report will be automatically printed out whenever information on 30 operations has accumulated. (A report can still be printed on demand at any time.)
- ◆ All information is erased after a report is printed out. If automatic print-out is turned off and print-out has not been done manually for 30 operations, the information on the oldest operation will be overwritten each time a new operation is performed.

```

*****
*
*                               TRANSMISSIONS ACTIVITY REPORT
*
*                               JUL-07-1998 03:51 PM
*
*   FOR: John Doe Corp.           201 555 1234
*
+----+-----+-----+-----+-----+-----+-----+-----+
|#D. | DATE  | START | RECEIVER | TX TIME | PAGES | TYPE | NOTE |
+----+-----+-----+-----+-----+-----+-----+-----+
* 1 | JUL-07 | 03:34 PM | N.Y. | 41" | 1 | SEND | OK |
* 2 | JUL-07 | 03:35 PM | | 1'21" | 2 | BROADCAST | |
* 3 | JUL-07 | 03:38 PM | JACK SMITH | 58" | 2 | SEND(M) | OK |
* 4 | JUL-07 | 03:45 PM | JACK SMITH | 40" | 1 | TIMER SEND | OK |
+----+-----+-----+-----+-----+-----+-----+-----+
*
*                               TOTAL           3'41"    6
*
*                               GRAND TOTAL TIME:      4M 21S
*                               PAGES:                7
*
*****

```

**Explanation of headings**

**SENDER/RECEIVER** The fax number of the other machine involved in the transaction. If this machine does not have an ID function, the communication mode will appear (for example, "G3").

**PAGES** Number of pages transmitted or received.

**NOTE** **OK** - Transmission/reception was normal.

**P.FAIL** - A power failure occurred. If you have power and the problem persists, try a different outlet. If necessary, have an electrician check your power lines.

**JAM** - A problem with the paper or original document occurred. Make sure the paper or document is loaded properly. Make sure the operation panel is shut securely.

**NO PAPER** - You ran out of paper during reception.

**COME-0** to **COME-7** - A telephone line error prevented the transaction. See *Line Error* in Chapter 11.

**CANCEL** - Transmission was cancelled because the **STOP** key was pressed, no document was in the feeder, or the other machine requested transmission using a function which your fax does not have. If you were attempting to fax, make sure a document is in the feeder. If you were receiving, contact the faxing party to see how they are trying to send to you.

### Timer List

This list shows the timer operations that are currently set.

TIMER LIST		JUL-07-1998 02:46 PM
FOR: John Doe Corp.		201 555 1234
TIMER SEND		
START	05:15 PM	
RECEIVER	N.Y.	
RESOLUTION	FINE	:AUTO
TIMER POLLING		
START	10:00 AM	
SENDER	JACK SMITH	

### Telephone Number List

This list shows the fax and voice numbers that have been stored for automatic dialing.

TELEPHONE NUMBER LIST			JUL-07-1998 02:41 PM
FOR: John Doe Corp.			201 555 1234
SPEED #	NAME	TELEPHONE #	
01	N.Y.	123-785-6340	
02	JACK SMITH	125-563-8462	
03	ANDERSON	230-347-6385	
04	JANE	812-937-0142	
05	MACDONALD	370-552-2836	

### Passcode List

This list shows settings made for polling security, your name and fax/telephone number as entered in the machine, and a sample of the header printed at the top of every page you transmit (**HEADER PRINT**).

PASSCODE LIST		JUL-07-1998 02:43 PM	
FOR: Jche Doe Corp.		201 555 1234	
POLLING MODE	SECURITY OFF		
PASSCODE #	01	1237856340	
	02	1255638462	
	03		
	04		
	05		
	06		
	07		
	08		
	09		
	10		
PRIORITY CALL #	2015568267		
DAY LIGHT SAVING TIME	YES		
SENDER'S NAME	Jche Doe Corp.		
SENDER'S TELEPHONE NUMBER	201 555 1234		
HEADER PRINT	JUL-07-1998 02:43 PM Jche Doe Corp. 201 555 1234 P.01		

### Option Setting List

This list shows the current status of the option settings.

OPTIONS SETTING LIST			NOV-17-1998 06:02 PM	
FOR: AL			123 3536	
NO.	ITEM	SETTING		
1	FINE PRIORITY	NO		
2	NUMBER OF RINGS IN AUTO ANSWER MODE	4 RINGS		
3	RECALL INTERVAL	05 MINUTES		
4	RECALL TIMES	02 TIMES		
5	TEL/FAX REMOTE #	(S)**		
6	REMOTE RECEPTION	YES		
7	TRANSACTION PRINT SELECT	ERROR ONLY		
8	DIAL MODE	TONE		
9	QUIET DETECT TIME	04 SECONDS		
10	FAX ANSWER WHEN TAD FAILS	NO		
11	DISTINCTIVE RINGING	OFF		
12	FAX SIGNAL RECEIVE	YES		
13	JUNK # CHECK	NO		
14	POLLING	NO		
15	CALLER-ID	YES		
16	COVER SHEET	YES		
17	AUTO PRINT OUT	NO		

### Anti Junk Number List

This list shows the numbers that are blocked by the Anti Junk function.

ANTI JUNK NUMBER LIST		JUL-07-1998 02:50 PM
ANTI JUNK # CHECK : NO		
STORED LOCATION	JUNK FAX #	
1	2015546621	
2	2014573321	
3	1023570251	

### Caller ID List

This list shows information about your most recent calls (maximum of 20 calls). (This list is only available if you are using the Caller ID function.)

CALLER-ID LIST		JUL-07-1998 03:20 PM			
AREA CODE: 123					
FOR: John Doe Corp.		201 555 1234			
NO.	DATE	RX TIME	NAME	TELEPHONE #	MODE
01	JUL-07	03:10 PM	ANDERSON ALLEN	201-556-8267	FAX
02	JUL-07	03:11 PM	MACDONALD MIKE	102-872-6621	FAX
03	JUL-07	03:11 PM	SMITH SHARON	202-441-3900	A.M.
04	JUL-07	03:12 PM	JONES JENNIFER	963-4451	TEL

### Print Setup List

This list shows the current status of the printing settings accessed by pressing the **FUNCTION** key and the **6** key.

PRINT SET UP LIST		
FOR:		FEB-03-1999 09:36 AM
NO.	ITEM	SETTING
1	INITIALIZE FILM	FEB-01-1999
2-1)	RECEPTION RATIO	AUTO
2-2)	PRINTING RATIO IN MEMORY FULL	93%
3	2 IN 1 PRINT	NO
4	PRINT CONTRAST	NORMAL
5	PAPER SIZE SET	LETTER
6	COPY CUT OFF	YES

### Transaction Report

This report is printed out automatically after an operation is completed to allow you to check the result. Your fax is set at the factory to print out the report only when an error occurs. If desired, you can change the setting to have it printed out under a variety of other conditions. This is done by changing Option Setting 7 (Transaction Report Print Select) as described in Chapter 8.

- ◆ The same headings appear in the Transaction Report as in the Activity Report. See *Activity Report* in this chapter for an explanation of the headings.
- ◆ The Transaction report cannot be printed on demand.

## Maintenance

### Fax print head

Clean the printing head frequently to assure optimum printing performance.

- 1 Unplug the power cord.

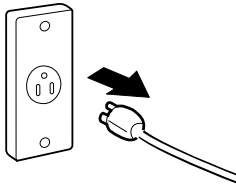

- 2 Pull the paper release plate forward and remove the paper.

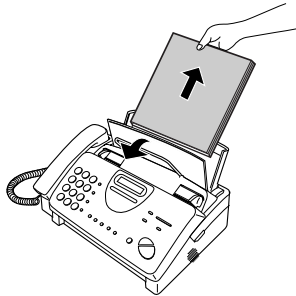

- 3 Open the operation panel (grasp the finger hold and pull up), and then pull the release on the right side of the machine forward to open the print compartment cover.

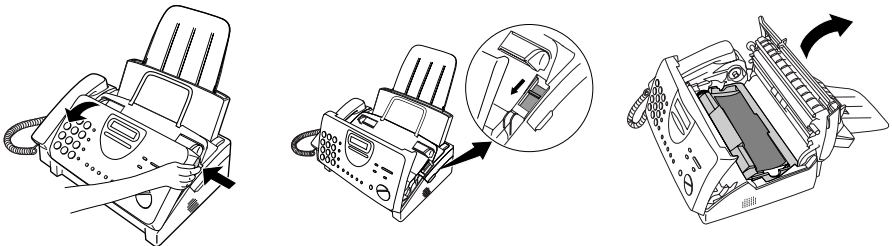



- 4 Take the imaging film cartridge out of the print compartment and place it on a sheet of paper.

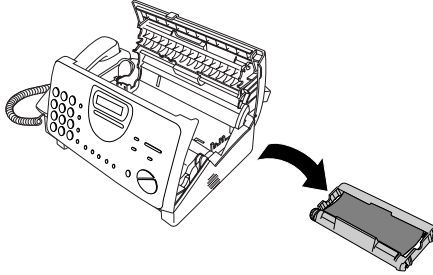

- 5 Wipe the print head and roller with denatured alcohol.

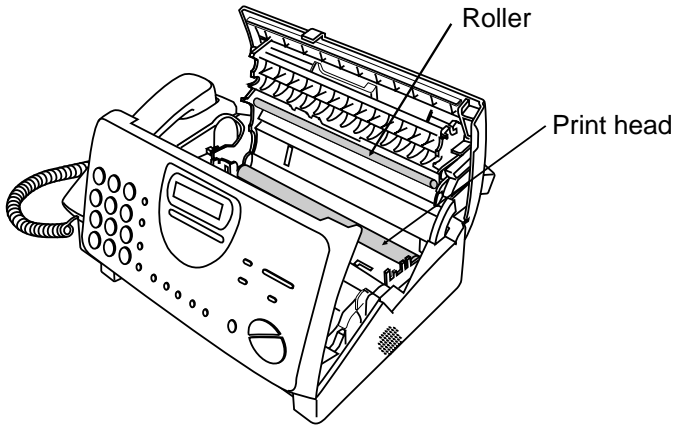
**Caution!**

- Do not use benzene or thinner. Avoid touching the print head with hard objects.
- The print head may be hot if your fax machine has just received a large number of documents. If this is the case, allow the print head to cool prior to cleaning.

- 
- 6** Place the imaging film cartridge back in the print compartment.

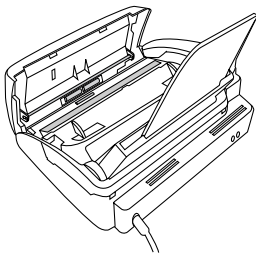

- 
- 7** Close the print compartment cover (press down on both sides to make sure it clicks into place), and then close the operation panel.

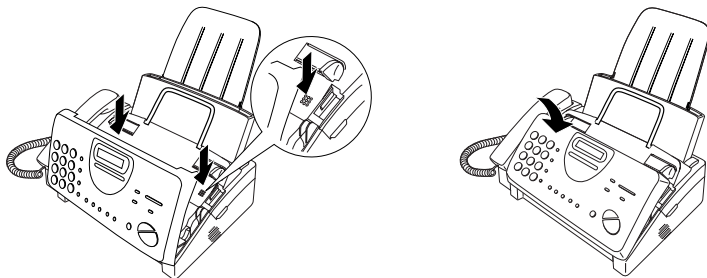

- 
- 8** Reinsert the paper in the paper tray and push the paper release plate back down.

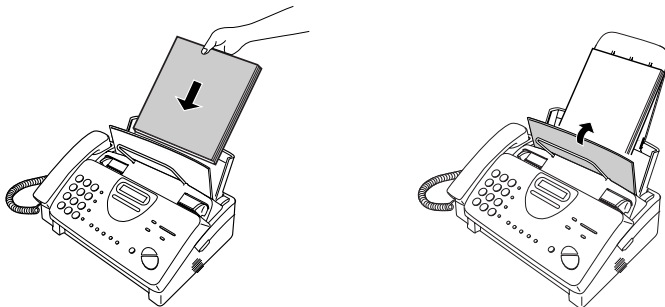

## Scanning glass and rollers

Clean the scanning glass and rollers frequently to ensure the quality of transmitted images and copies. Open the operation panel (grasp the finger hold and pull up), and wipe the scanning glass and rollers with a soft cloth.

- ◆ Make sure that all dirt and stains (such as correcting fluid) are removed, as dirt and stains will cause vertical lines on transmitted images and copies.
- ◆ Adhesive cellophane tape is useful for removal of debris from the rollers.

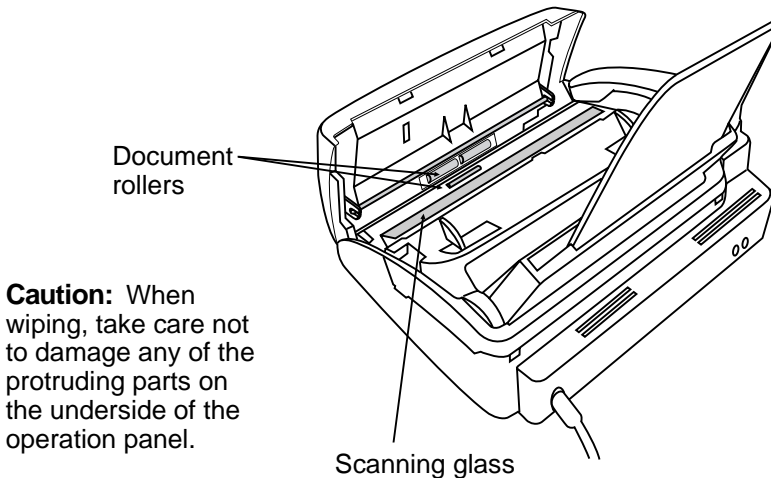

**Caution:** When wiping, take care not to damage any of the protruding parts on the underside of the operation panel.

## The housing

Wipe the external parts and surface of the machine with a dry cloth.

### Caution!

- Do not use benzene or thinner. These solvents may damage or discolor the machine.

# Troubleshooting

## Problems and Solutions

If you have any problems with your fax, first refer to the following troubleshooting guide. If you cannot solve the problem, call Sharp's Customer Assistance Center at 1-800-BE SHARP.

### Answering machine hookup

Problem	Check and remedy
<p>The answering machine hookup does not operate properly.</p>	<ul style="list-style-type: none"> <li>● Make sure your fax machine's reception mode is set to A.M.</li> <li>● Make sure your fax machine's <b>TEL. LINE</b> jack is connected to the wall jack. Make sure your fax machine's <b>TEL. SET</b> jack is connected to your answering machine's telephone line jack (not the answering machine's extension phone jack).</li> <li>● Make sure your answering machine's outgoing message is under 10 seconds.</li> <li>● Make sure that Option Setting 9 (Quiet Detect Time) is set to three or four seconds (see Chapter 8).</li> <li>● Make sure that the Distinctive Ring function is set to OFF SETTING (see <i>Distinctive Ring</i> in Chapter 7).</li> <li>● If you have checked all of the above and the hookup still doesn't operate properly, call the Customer Assistance Center.</li> </ul>

**Line error**

Problem	Check and remedy
<p>LINE ERROR appears in the display and/or a transaction report is printed out with <b>COM. E-</b> and a number from <b>0</b> to <b>1, 2, 3, 4, 5, 6,</b> or <b>7</b> in the <b>NOTE</b> column.</p>	<ul style="list-style-type: none"> <li>● Try the transaction again. If the error persists, check the following:</li> <li>● Check the hookup. The cord from the <b>TEL. LINE</b> jack to the wall jack should be no longer than six feet.</li> <li>● Make sure there are no modem devices sharing the same telephone line.</li> <li>● Check with the other party to make sure their fax machine is functioning properly.</li> <li>● Have your telephone line checked for line noise.</li> <li>● Try connecting your fax to a different telephone line.</li> <li>● If the problem still occurs, your fax machine may need service.</li> </ul>

**Dialing and transmission problems**

Problem	Check and remedy
<p>No dial tone when you pick up the handset or press the <b>SPEAKER</b> key.</p>	<ul style="list-style-type: none"> <li>● Make sure the handset cord is connected to the correct jack. See <i>Handset</i> in <i>Connections</i> in Chapter 1.</li> </ul>
<p>Dialing is not possible.</p>	<ul style="list-style-type: none"> <li>● Make sure the power cord is properly plugged into a power outlet.</li> <li>● Make sure that the telephone line is properly connected to both the <b>TEL. LINE</b> jack and the wall jack.</li> <li>● Make sure that the fax is set to the correct dialing mode for your telephone line. See Option Setting 8 in Chapter 8.</li> </ul>

<p>The power is on, but no transmission takes place.</p>	<ul style="list-style-type: none"> <li>● Make sure that the receiving machine has fax paper.</li> <li>● Make sure that the telephone line cord is plugged into the <b>TEL. LINE</b> jack, and not the <b>TEL. SET</b> jack.</li> <li>● If the receiving machine is in manual mode with no attendant, reception will not be possible.</li> <li>● If the receiving machine is not a Sharp model, make sure it is G3 compatible.</li> <li>● Check the display for error messages.</li> <li>● Pick up the handset and check for a dial tone.</li> </ul>
<p>Nothing is printed at the receiving end.</p>	<ul style="list-style-type: none"> <li>● Make sure that the document for transmission is placed face down in the feeder.</li> </ul>
<p>A distorted image is received at the other end.</p>	<ul style="list-style-type: none"> <li>● Noise on the telephone line may cause distortion. Try sending the document again.</li> <li>● Make a copy of the document on your fax. If the copy is also distorted, your fax may need service.</li> </ul>

***Reception and copying problems***

<p><b>Problem</b></p>	<p><b>Check and remedy</b></p>
<p>The fax machine doesn't receive documents automatically.</p>	<ul style="list-style-type: none"> <li>● Make sure that the reception mode is set to FAX. If you subscribe to a distinctive ring service, make sure that the Distinctive Ring function is set to the correct ring pattern. If you do not subscribe to a distinctive ring service, make sure that Distinctive Ring is set to OFF SETTING. (See <i>Distinctive Ring</i> in Chapter 7.)</li> </ul>
<p>The power is on, but no reception takes place.</p>	<ul style="list-style-type: none"> <li>● Make sure that the wall jack is connected to the <b>TEL. LINE</b> jack, and <b>not</b> the <b>TEL. SET</b> jack.</li> </ul>

The printing paper comes out blank when you try to receive a document.	<ul style="list-style-type: none"> <li>● Make sure that the document is loaded properly in the feeder of the transmitting machine. Make a copy to confirm the printing ability of your machine.</li> </ul>
General print quality is poor.	<ul style="list-style-type: none"> <li>● It is important to select a paper that is appropriate for the thermal transfer printer in your fax. We recommend using laser quality paper that has a very smooth finish. Copier paper will work, but it sometimes tends to yield a lighter print quality.</li> </ul>
The received document is faint.	<ul style="list-style-type: none"> <li>● Ask the other party to send higher contrast documents. If the contrast is still too low, your fax may have a problem. Make a copy to check it.</li> </ul>
Received images are distorted.	<ul style="list-style-type: none"> <li>● Noise on the telephone line may cause distortion. Have the other party try sending the document again.</li> <li>● The print head may be dirty. See <i>Fax print head</i> in Chapter 10.</li> <li>● Make a copy of another document on your fax. If the copy is also distorted, your fax may need service.</li> </ul>
The quality of copies is poor and/or black spots appear.	<ul style="list-style-type: none"> <li>● Any dirt or material on the scanning glass will cause spots to appear on copies and transmitted faxes. Clean the fax print head and the scanning glass as explained in Chapter 10.</li> </ul>
Reception/copying is interrupted.	<ul style="list-style-type: none"> <li>● If reception or copying takes place continuously for a long time, the print head may overheat. Turn off the power and let it cool down.</li> </ul>
A received document or copy prints out in strips.	<ul style="list-style-type: none"> <li>● Make sure the operation panel and the printer compartment cover under the operation panel are completely closed (press down on both sides of each). (To close the printer compartment cover, grasp the top of the operation panel and pull to open it, and then press down on both sides of the printer compartment cover.)</li> </ul>

**General problems**

<b>Problem</b>	<b>Check and remedy</b>
Information cannot be programmed in the fax.	<ul style="list-style-type: none"><li>● Make sure the fax is plugged in and the imaging film and paper have been loaded. (Programming is not possible if the imaging film and printing paper have not been loaded.) See <i>Loading the Imaging Film</i> and <i>Loading Printing Paper</i> in Chapter 1.</li></ul>
Nothing appears in the display.	<ul style="list-style-type: none"><li>● Make sure the power cord is properly plugged into a power outlet.</li><li>● Connect another electrical appliance to the outlet to see if it has power.</li></ul>
The machine does not respond when you press any of its keys.	<ul style="list-style-type: none"><li>● If a beep sound is not made when you press the keys, unplug the power cord and then plug it back in several seconds later.</li></ul>
Automatic document feeding does not work for transmission or copying.	<ul style="list-style-type: none"><li>● Check the size and weight of the document (see <i>Transmittable Documents</i> in Chapter 2).</li></ul>
Voice calls taken on an extension phone are interrupted by the fax.	<ul style="list-style-type: none"><li>● The fax may interrupt during a voice call if the reception mode is set to A.M. To prevent interruption on a touch-tone extension phone, press any three keys on the extension phone after answering. (Note: Do not enter the code to activate fax reception.)</li></ul>
No reception occurs when polling is attempted.	<ul style="list-style-type: none"><li>● Make sure you have not run out of paper.</li><li>● Make sure the transmitting machine is in automatic reception mode.</li><li>● If the transmitting machine has polling security, make sure that your fax number has been entered both in your machine and in the transmitting machine.</li></ul>



## Messages and Signals

### Display messages

**Note:** If you have turned on the Caller ID function, see *Caller ID* in Chapter 7 for display messages related to Caller ID.

CHECK PAPER SIZE	The paper size setting is incorrect. Change the paper size setting as described in <i>Loading the Paper</i> in Chapter 1.
COVER OPEN	The print compartment cover (under the operation panel) is open. Open the operation panel (grasp the top and pull toward you), and then press down firmly on both sides of the print compartment cover to close it.
DOCUMENT JAM	The original document is jammed. See the following section, <i>Clearing Paper Jams</i> .
FAX RX IN MEMORY	A fax has been received in memory because the imaging film needs replacement, you have run out of printing paper, or the paper is jammed. The fax will print out automatically when the problem is fixed.
FILM END	The imaging film may need replacement. Check the film and replace if necessary.
FUNCTION MODE	The <b>FUNCTION</b> key has been pressed.
HOLD	The <b>HOLD/SEARCH</b> key has been pressed to put the other party on hold during a phone conversation. Press the <b>HOLD/SEARCH</b> again to take the other party off hold.
LINE ERROR	Transmission or reception was not successful. Press <b>STOP</b> to clear the message, and then try again. If the error persists, see <i>Line Error</i> in <i>Problems and Solutions</i> in this chapter.
LINE IS IN USE	An extension phone connected to the fax is being used. Do not lift the fax's handset or attempt transmission at this time, as this will interrupt the conversation on the extension phone.

---

## Display Messages

MEMORY IS FULL	The memory is full. This may occur during fax reception if too much data is received before the pages can be printed out. If faxes have been received to memory because printing is not possible (an additional message will indicate the problem), resolve the problem so that printing can continue (see <i>Substitute Reception to Memory</i> in Chapter 3). If you are attempting to transmit from memory, see <i>Sending Documents from Memory</i> in Chapter 7.
MEMORY PRINTING	The fax is preparing to or printing out a document from memory.
NO DATA	This appears if you attempt to search for an automatic dialing number when none have been stored.
NO # STORED	You have tried to dial or clear a Rapid Key or Speed Dial number that hasn't been programmed (a full number hasn't been assigned to it).
OUT OF PAPER	You are out of printing paper (or the paper release plate is open). Load paper as described in <i>Loading Printing Paper</i> in Chapter 1.
ON HOOK DIAL	The <b>SPEAKER</b> key has been pressed and the fax is waiting for you to dial. (To return to the date and time display, press the <b>SPEAKER</b> key again.)
OVER HEAT	The print head has overheated. Operation can be continued once it cools.
PAPER JAMMED	The printing paper is jammed. See the following section, <i>Clearing Paper Jams</i> .
READY TO SEND	A document has been loaded and the fax is waiting for transmission or copying instructions.
RECALLING	This appears if you attempt to send a fax by automatic dialing and the line is busy or the receiving fax machine does not answer. Your fax machine will automatically reattempt the call. (See <i>Automatic Redialing in Sending a Fax by Automatic Dialing</i> in Chapter 2.)

SEARCH DIAL	The <b>HOLD/SEARCH</b> key has been pressed. Press <b>#</b> or <b>*</b> to search for an automatic dialing number, or press <b>STOP</b> to return to the data and time display. (See <i>Using the HOLD/SEARCH key in Sending a Fax by Automatic Dialing</i> in Chapter 2.)
TOTAL PAGE(S) 01	Number of pages transmitted, received, or copied.

**Audible signals**

Continuous tone	3 seconds	Indicates the end of transmission, reception, or copying.
Intermittent tone (3 beeps)	5 seconds (1 second on, 1 second off)	Indicates incomplete transmission, reception, or copying.
Rapid intermittent tone	35 seconds (0.7 seconds on, 0.3 seconds off)	Indicates that the handset is off hook.

## **Clearing Paper Jams**

### **Clearing a jammed document**

If the original document doesn't feed properly during transmission or copying, or DOCUMENT JAMMED appears in the display, first try pressing the **START/MEMORY** key. If the document doesn't feed out, open the operation panel and remove it.

#### **Important:**

Do not try to remove a document without opening the operation panel. This may damage the feeder mechanism.

---

- 1** Open the operation panel by grasping the finger hold and pulling up.

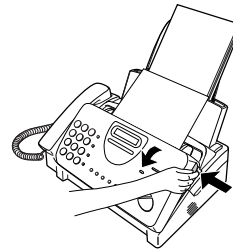

- 2** Remove the document.

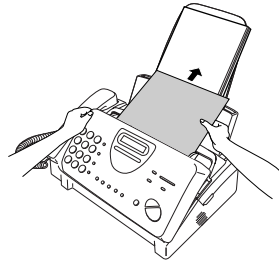

- 3** Close the operation panel, making sure it clicks into place.

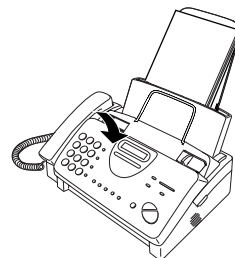

Click!

### Clearing jammed printing paper

- 1 Pull the paper release plate forward and remove the paper.

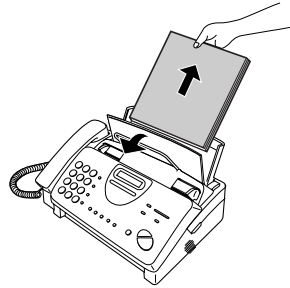

- 2 Open the operation panel (grasp the finger hold and pull up), and then pull the release on the right side of the machine forward to open the print compartment cover.

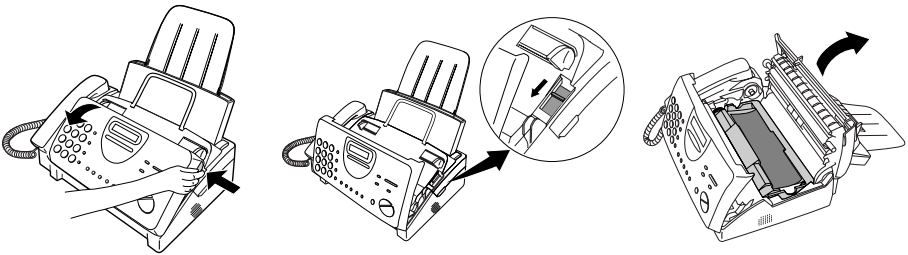

- 3 Gently pull the jammed paper out of the machine, making sure no torn pieces of paper remain in the print compartment or rollers.

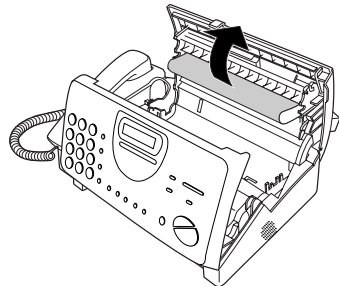

- 4** Close the print compartment cover (press down on both sides to make sure it clicks into place), and then close the operation panel.

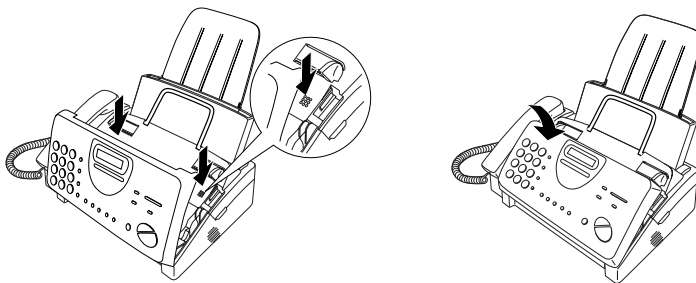

- 
- 5** Reinsert the paper in the paper tray and push the paper release plate back down.

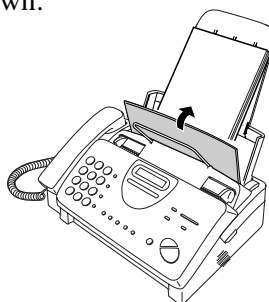

---

## Ordering parts

To order parts, contact the parts distribution center located nearest you. When ordering a part, use the part order number shown below.

Operation manual	TINSE3912XHZA
Rapid Key labels	TLABH4751XHZZ
Handset cord	QCNW-3976XHOW
Telephone line cord	QCNW-3975XHGY
Handset	DUNTK464BXHWH
Paper tray extension	LPLTP3003XHSA
Original document support	PHOP-2102XHZZ
Imaging film cartridge	CPLTP3002XHB1
Gears	NGERH2455XHZZ (large gear) NGERH2456XHZZ

### Part distribution centers

Panson Electronics I-80 and New Maple Ave. Pine Brook, NJ 07058	Tel: 1-800-255-5229 Fax: 1-800-332-3922
Tritronics, Inc. 1306 Continental Drive Abingdon, MD 21009	Tel: 1-800-638-3328 Fax: 1-800-888-FAXD
Tritronics, Inc. 1015 NW 52nd Street Ft. Lauderdale, FL 33309	Tel: 1-800-365-8030 Fax: 1-800-999-FAXD
Fox International, Ltd. 23600 Aurora Road Bedford Heights, OH 44146	Tel: 1-800-321-6993 Fax: 1-800-445-7991
Andrews Electronics 25158 Avenue Stanford Santa Clarita, CA 91355	Tel: 1-800-274-4666 Fax: 1-805-295-5126
Sharp Accessories and Supply Center 2130 Townline Road Peoria, IL 61615	Tel: 1-800-642-2122

---

## ***FCC Regulatory Information***

This equipment complies with FCC rules, Part 68. On this equipment is a label that contains, among other information, the FCC Registration Number and Ringer Equivalence Number (REN) for this equipment. If requested, this information must be provided to your telephone company.

An FCC compliant telephone cord and modular plug is provided with this equipment. This equipment is designed to be connected to the telephone network or premises wiring using a compatible modular jack which is Part 68 compliant. This equipment connects to the telephone network through a standard USOC RJ-11C network interface jack.

The REN is used to determine the quantity of devices which may be connected to your telephone line and still have all of those devices ring when your number is called. Too many devices on one line may result in the devices not ringing in response to an incoming call. In most, but not all, areas as the sum of the RENs of all devices should not exceed five (5.0). To be certain of the number of devices that may be connected to your line, as determined by the total RENs, contact your local telephone company.

If this equipment causes harm to the telephone network, your telephone company may disconnect your service temporarily. If possible, they will notify you in advance. If advance notice is not practical, you will be notified as soon as possible. You will also be advised of your right to file a complaint with the FCC.

Your telephone company may make changes in its facilities, equipment, operations, or procedures that could affect the operation of your equipment. If this happens, the telephone company will provide advance notice in order for you to make necessary modifications to maintain uninterrupted service.

If you have any questions or problems which cannot be solved by reading this manual, please contact Sharp's Customer Information Center. The number is 1-800-BE SHARP. If the equipment is causing harm to the telephone network, your telephone company may ask you to disconnect the equipment until the problem have been resolved.

This equipment may not be used on coin service provided by the telephone company. Connection to party lines is subject to state tariffs. Contact your state's public utility commission, public service commission, or corporation commission for more information.

This equipment is hearing-aid compatible.

When programming and/or making test calls to emergency numbers:

- Remain on the line and briefly explain to the dispatcher the reason for the call.
- Perform such activities in the off-peak hours, such as early morning or late evening.



# QUICK REFERENCE GUIDE

## INSTALLATION

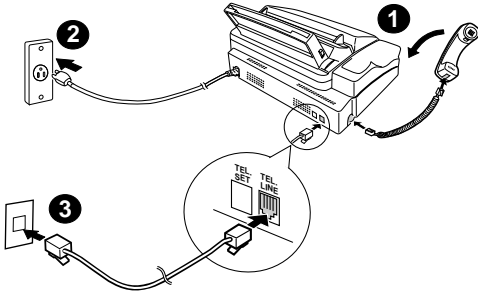

1. Connect the handset as shown.
2. Plug the power cord into a grounded, 120 V outlet.
3. Plug one end of the telephone line into the **TEL. LINE** jack on the rear of the fax, and the other end into your telephone wall jack.

### Connecting an answering machine and/or extension telephone

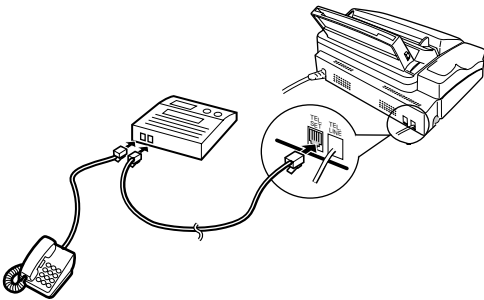

1. Remove the seal covering the **TEL. SET** jack on the rear of the fax. Connect an extension telephone or answering machine to the **TEL. SET** jack.
2. If desired, connect an extension phone to the answering machine.

## ENTERING YOUR NAME AND NUMBER

**Note:** Imaging film and paper must be loaded to perform the following operation.

1. Press: **FUNCTION** **3** **#** **#**

Display shows: **OWN NUMBER SET**

2. Press: **START/MEMORY**
3. Enter your fax number (max. of 20 digits) by pressing the number keys.
  - ◆ If you make a mistake, press the **HOLD/SEARCH** key to move the cursor back to the mistake, then enter the correct number or letter.
4. Press: **START/MEMORY**
5. Enter your name by pressing the appropriate number keys as shown below.
  - ◆ To enter two letters in succession that require the same key, press the **SPEAKER** key after entering the first letter.

A = 2 2	J = 5 5	S = 7 7 7 7 7
B = 2 2 2	K = 5 5 5	T = 8 8
C = 2 2 2 2	L = 5 5 5 5	U = 8 8 8
D = 3 3	M = 6 6	V = 8 8 8 8
E = 3 3 3	N = 6 6 6	W = 9 9
F = 3 3 3 3	O = 6 6 6 6	X = 9 9 9
G = 4 4	P = 7 7	Y = 9 9 9 9
H = 4 4 4	Q = 7 7 7	Z = 9 9 9 9 9
I = 4 4 4 4	R = 7 7 7 7	SPACE = 1 1

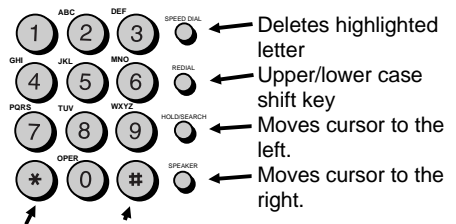

Press either key one or more times to select and enter a symbol.

6. When finished, press: **START/MEMORY** **STOP**

## SETTING THE DATE AND TIME

**Note:** Imaging film and paper must be loaded to perform the following operation.

Press:      

Display shows: DATE & TIME SET

Press the **START** key: 

Enter two digits for the Month (01 through 12).



Enter two digits for the Day (01 through 31).

Enter four digits for the Year (Ex: 1999).

Enter two digits for the Hour (01 through 12).

Enter two digits for the Minute (00 through 59).

Press the \* key for A.M. or the # key for P.M.

When finished, press:  

## STORING AND CLEARING NUMBERS FOR AUTO DIALING

**Note:** Imaging film and paper must be loaded to perform the following operation.

1. Press:   

Display shows: FAX/TEL # MODE

2. Press **1** to store a number or **2** to clear a number.

3. Enter a 2-digit Speed Dial number (from 01 to 05 for Rapid Key Dialing, or 06 to 45 for Speed Dialing). (If you are clearing a number, go to Step 7.)

4. Enter the full telephone/fax number.

5. Press: 

6. Enter the name of the location by pressing number keys (max. of 20 characters). (Refer to the letter entry table in *ENTERING YOUR NAME AND NUMBER*.)



7. Press:  

## SENDING DOCUMENTS

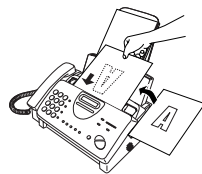
Place your document (up to 10 pages) face down in the document feeder.



### Normal Dialing

1. Lift the handset or press  
2. Dial the fax number.
3. Wait for the reception tone (if a person answers, ask them to press their Start key).
4. Press: 

### Rapid Key Dialing

Press the appropriate Rapid Key. Transmission will begin automatically.

### Speed Dialing

1. Press:  
2. Enter 2-digit Speed Dial number.
3. Press: 

## RECEIVING DOCUMENTS

Press: 

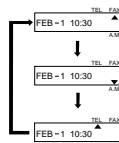

**FAX** mode: The fax automatically answers on four rings and receives the incoming document.

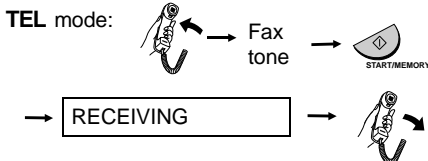

**A.M.** mode: Select this mode when an answering machine is connected to the fax and the answering machine is turned on.

## INSTALACIÓN

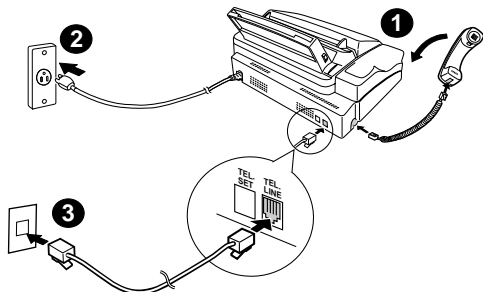

1. Conecte el microteléfono como se muestra.
2. Enchufe la unidad en su toma de CA de la pared.
3. Conecte la toma **TEL LINE** a su toma telefónica de la pared.

## INSTALACIÓN CON UN CONTESTADOR AUTOMÁTICO Y UN TELÉFONO DE EXTENSIÓN

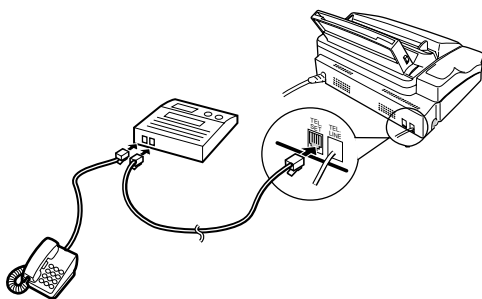

1. Quite el sello que cubre la toma **TEL SET** del panel trasero del facsimile. Conecte el teléfono de extensión a la toma **TEL SET**.
2. Conecte la toma **TEL LINE** del contestador automático a la toma **TEL SET** del facsimile.

## INTRODUCCIÓN DE SU NOMBRE Y NÚMERO

1. Presione: **FUNCTION**



El visualizador mostrar: OWN NUMBER SET

2. Presione: **START/MEMORY**

3. Introduzca su número de fax empleando el teclado. Se pueden introducir un máximo de 20 dígitos.

◆ Si se equivoca, pulse la tecla **HOLD/SEARCH** para mover el cursor al error. Al introducir el dato correcto se borra el error.

4. Presione: **START/MEMORY**

5. Introduzca su nombre empleando el teclado.

◆ Para introducir dos letras seguidas que requieran emplear la misma tecla, pulse la tecla **SPEAKER** después de introducir la primera letra.

A = 2 2	J = 5 5	S = 7 7 7 7 7
B = 2 2 2	K = 5 5 5	T = 8 8
C = 2 2 2 2	L = 5 5 5 5	U = 8 8 8
D = 3 3	M = 6 6	V = 8 8 8 8
E = 3 3 3	N = 6 6 6	W = 9 9
F = 3 3 3 3	O = 6 6 6 6	X = 9 9 9
G = 4 4	P = 7 7	Y = 9 9 9 9
H = 4 4 4	Q = 7 7 7	Z = 9 9 9 9 9
I = 4 4 4 4	R = 7 7 7 7	SPACE = 1 1

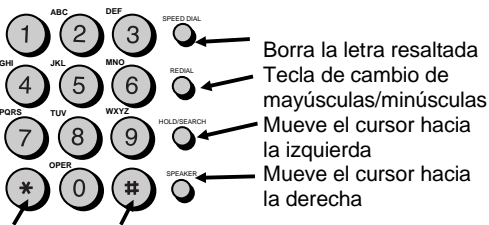

Para desplazarse a través del grupo de símbolos.

6. Presione: **START/MEMORY** **STOP**

# INSERCIÓN DE FECHA Y HORA

Presione: **3**

El visualizador mostrará: DATE & TIME SET

Presione:

Introduzca 2 dígitos para el mes (01 a 12).  
 Introduzca 2 dígitos para el día del mes (01 a 31).  
 Introduzca 4 dígitos para el año (Ex: 1999).  
 Introduzca 2 dígitos para la hora (01 a 12).  
 Introduzca 2 dígitos para el minuto (00 a 59).

Pulse: "\*" para AM o "#" para PM.

Después de introducir todos los caracteres, pulse:

# ENVO DE DOCUMENTOS

Ponga su documento (hasta 10 páginas) con el lado impreso hacia abajo en el alimentador de documentos.

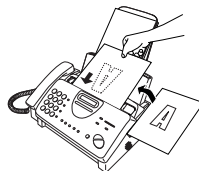

## Marcación normal

1. Levante el microteléfono o pulse
2. Marque el número de fax empleando el teclado.
3. Espere a oír el tono de recepción.
4. Presione:

## Marcación con teclas rápidas

Marcación mediante tecla rápida: Pulse la tecla rápida apropiada y la transmisión empezará automáticamente.

## Marcación veloz

1. Presione:
2. Introduzca el número de marcación rápida empleando el teclado.
3. Presione:

# MEMORIZACIÓN Y BORRADO DE NÚMEROS DE LAS MARCAS AUTOMÁTICAS

1. Presione: **3**

El visualizador muestra: FAX/TEL # MODE

2. Presione: **1**

Presione "2" y luego introduzca un número de dos dígitos para designar el número de marcación rápida.

3. Introduzca un número de dos dígitos ("01" a "45") para designar el número de marcación rápida. Este será el número de dos dígitos que usted empleará para marcar el número deseado.

4. Presione:

5. Introduzca el nombre del lugar o de la persona al que pertenece este número de marcación rápida (máximo de 20 caracteres).

6. Presione:

7. Introduzca el nombre del lugar o persona al que este número de ha sido asignado.

8. Presione:

# RECEPCIÓN DE DOCUMENTOS

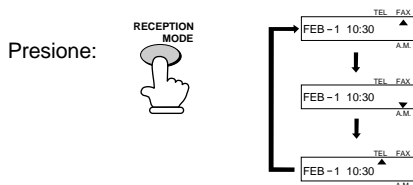

**FAX** modo: El fax sonará cuatro veces y recibirá automáticamente los documentos entrantes.

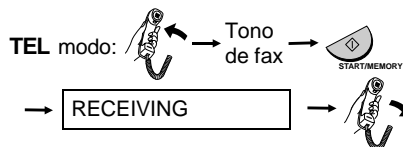

**A.M.** modo: Elija este modo cuando Vd. va a salir y desea que un contestador automático conteste todas las llamadas.

---

# Index

## A

- A.M. reception mode, 30
- Activity Report, 96
  - Automatic printing, 95
- Answering machine hookup
  - Activating, 63
  - Connecting, 62
  - Fax Reception When TAD Fails, 92
  - Quiet Detect Time, 92
  - Troubleshooting, 106
- Anti junk fax, 79, 93
- Anti Junk Number List, 100
- Audible signals, 113
- Auto cover sheet, 95
- Automatic dialing, 45
- Automatic dialing, storing numbers, 42

## B

- Batch page numbering, 77
- Broadcasting, 72

## C

- Caller ID, 65
- Caller ID List, 67, 100
- Chain Dialing, 60
- Cleaning, 102, 105
- Contrast, 37
- Copies, 56
- Copy cut-off setting, 58
- Copy/Help key, 9, 56
- Cover sheet, 95

## D

- Date, setting, 27
- Daylight Saving Time, 29
- Dial mode, 91
- Dialing
  - Direct Keypad, 47
  - Normal, 39, 59
  - Rapid Key, 45, 59

- Search, 48, 60
- Speed, 46, 59
- Direct Keypad Dialing, 47
- Display, 8
- Display messages, 111
- Distinctive Ring, 70
- Document feeder, 35
- Document guides, 35
- Document restrictions, 34
- Document rollers, 105
- Document sizes, 33
- Document, maximum scanning size, 34

## E

- Extension telephone
  - Connecting, 15
  - Using, 52

## F

- FAX reception mode, 30, 50
- Fax Signal Receive, 93
- Fine Resolution Priority, 88
- Function key, 9

## H

- Halftone, 37
- Handset, 11
- Handset receiver volume, 32
- Hold, 61
- Hold/Search key, 9, 60
- Housing, cleaning, 105

## I

- Imaging film, loading and replacing, 16
- Initialize film setting, 20

## J

- Jams, clearing, 114
- Junk fax number check, 93

### L

Letters, entering, 26  
Line error, 107  
Loading printing paper, 21  
Loading the document, 35

### M

Memory  
    Sending documents from, 81  
    Substitute reception to, 55

### N

Normal Dialing, 39, 59  
Number keys, 9  
Number of rings in AUTO mode, 89

### O

Option Setting List, 99  
Ordering parts, 117

### P

Panel release, 8  
Paper jams, clearing, 115  
Paper size setting, 22  
Passcode List, 99  
Pauses in automatic dialing, 42, 47  
Polling, 83 - 85  
Polling key, setting, 94  
Print contrast setting, 23  
Print head, cleaning, 102  
Print Setup List, 101  
Priority Call, 68

### R

Rapid Dial keys, 9  
Rapid Key Dialing, 45, 59  
Recall Times, 89  
Recall Wait Interval, 89  
Reception mode  
    A.M. mode, 30

FAX mode, 30, 50

Setting, 30

TEL mode, 30, 51

Reception mode key, 8, 30

Reception Ratio setting, 54

Redial key, 8, 40, 60

Redialing, 49, 60

Remote Reception Select, 90

Removing original document, 36

Resolution, 37

Resolution key, 9

Ringling volume, 32

Rollers, cleaning, 105

### S

Scanning glass, cleaning, 105  
Search Dialing, 48, 60  
Sender's name and number, entering, 24  
Speaker key, 9, 31, 39, 59  
Speaker volume, 31  
Speed Dial key, 8, 46, 59  
Speed Dialing, 46, 59  
START/MEMORY key, 9  
Stop key, 9

### T

TEL reception mode, 30, 51  
TEL. LINE jack, 13  
TEL. SET jack, 15, 62  
Tel/Fax Remote Number, 90  
Telephone line cord, 13  
Telephone Number List, 98  
Telephone, using as, 59  
Time, setting, 27  
Timer List, 98  
Timer operations, 86  
Transaction Report, 101  
Transaction Report Print Select, 91  
Two-in-one printing, 53

### V

Volume keys, 9, 31

## MATERIAL SAFETY DATA SHEET

MSDS No. B-1006

**Section 1. Product Identification**

Product Code: UX-3CR Imaging Film

**Section 2. Supplier's Name and Address**

Sharp Corporation

22-22 Nagaike-cho, Abeno-ku, Osaka, Japan

Local suppliers are listed below. Please contact the nearest supplier for additional information.

(Country)	(Name and Telephone Number)
U.S.A.	Sharp Electronics Corporation Telephone number for information: 1-800-237-4277 Emergency telephone number : 1-800-255-3924
Canada	Sharp Electronics of Canada Ltd. Telephone number for information: 905-890-2100 Emergency telephone number : 1-800-424-9300
United Kingdom	Sharp Electronics(U.K.)Ltd. Telephone number for information: 01923-474013

**Section 3. Ingredients**

Ingredients	CAS No.	Proportion	OSHA PEL	ACGIH TLV	Other Limits
Polyethylene terephthalate	25038-59-9	51.0 %	-	-	-
Carbon black	1333-86-4	8.5 %	3.5mg/m3	3.5mg/m3	-
Ethylene-vinyl acetate copolymer	24937-78-8	3.1 %	-	-	-
Ester wax	8015-86-9	5.6 %	-	-	-
Paraffin wax	8002-74-2	12.5 %	-	2mg/m3 (fume)	-
Microcrystalline wax	63231-60-7	15.2 %	-	-	-
Modified wax	8016-60-2	1.3 %	-	-	-
Polyester resin	27923-68-8	1.3 %	-	-	-
Others	-	1.5 %	-	-	-

**Section 4. Hazardous Identification (Emergency Overview)**

This product is ink film for thermal transfer facsimile. "Ink film" is a thin film coated with ink. It is no special hazard under normal use condition.

**Section 5. Health Hazard Data**

Route(s) of Entry:	Inhalation ?	Skin ?	Ingestion ?	+
	not applicable	not applicable	Possible but very unusual	+
Health Hazards:	The ingredients are not listed in ACGIH (1986) and OSHA (1989) except carbon black and paraffin wax			
Carcinogenicity:	In 1996 the IARC reevaluated carbon black as a Group 2B carcinogen (possible human carcinogen). This classification is given to chemicals for which there is inadequate human evidence, but sufficient animal evidence on which to base an opinion of carcinogenicity. The classification is based upon the development of lung tumors in rats receiving chronic inhalation exposures to free carbon black at levels that induce particle overload of the lung. Studies performed in animal models other than rats did not show any association between carbon black and lung tumors.			
Signs and Symptoms of Exposure:	not applicable			
Medical Conditions Generally Aggravated by Exposure:	not applicable			
Emergency and First Aid Procedures:	not applicable			

## MATERIAL SAFETY DATA SHEET

MSDS No. B-1006

**Section 6. Physical Chemical Characteristics**

Boiling/Melting Point	m.p. about 70 C for ink	Specific Gravity	about 1
Vapor Pressure	not applicable	Solubility in Water	negligible
Vapor Density	not applicable	PH	not applicable
Evaporation Rate	negligible	Viscosity	not applicable
Appearance	thin film coated with ink	Color	black
Odor	slight wax odor		

**Section 7. Fire and Explosion Data**

Flash Point (Method Used):	about 250 C for ink
Ignition Temperature:	not applicable
Flammable Limits:	(LEL); not applicable (UEL); not applicable
Extinguishing Media:	CO <sub>2</sub> , water, dry chemicals and form etc.
Special Fire Fighting Procedure:	none
Unusual Fire and Explosion Hazard:	none
Sensitivity to Mechanical Impact:	no hazardous effect by mechanical impact
Sensitivity to Static Charge:	not applicable

**Section 8. Reactivity Data**

Stability:	Stable
Incompatibility (Materials to Avoid):	none
Hazardous Decomposition:	not applicable
Hazardous Polymerization:	not applicable

**Section 9. Precautions for Safe Handling and Use**

Personal Protection Information (Respiratory, Eye Protection and Protective Glove):	not required
Engineering Control/Ventilation:	not required
Work/Hygienic Practice:	none
Steps to be taken in case of Spill or Leak:	If rumple the product and wax layer peel off, sweep up or clean with vacuum cleaner.
Waste Disposal Method:	If it dirty skin, wash with water and soap. If it clothes, wash by suitable method. Dispose in an approved incinerator or contract with licensed chemical disposal agency. Ensure conformity with governmental disposal regulations. (Dispose by the same method of ordinary plastic products.)

**Section 10. Regulatory Information**

NFPA Rating (U.S.A.):	no information
WHMIS Legislation (Canada):	not controlled
Transport Information:	no information
UN No.:	no information

**Section 11. Other information**

Reference :	IARC (1996) Monographs on the Evaluation of the Carcinogenic Risk of Chemicals to Humans, Vol. 65, Printing Process and Printing inks, Carbon Black and Some Nitro Compounds, Lyon, pp-149-261 H. Muhle, B. Bellmann, O. Creutzenberg, C. Dasenbrock, H. Ernst, R. Kilpper, J. C. Mackenzie, P. Morrow, U. Mohr, S. Takenaka, and R. Mermelstein (1991) Pulmonary Response to Toner upon Chronic Inhalation Exposure in Rats. Fundamental and Applied Toxicology 17, pp. 280-299
-------------	--



# LIMITED WARRANTY

SHARP ELECTRONICS CORPORATION warrants to the first end user purchaser that this Sharp brand product (the "Product"), when shipped in its original container, will be free from defective workmanship and materials, and agrees that it will, at its option, either repair the defect or replace the defective Product or part thereof with a new or remanufactured equivalent at no charge to the purchaser for parts or labor for the period(s) set forth below.

This warranty does not apply to any appearance items of the Product nor to the additional excluded item(s) set forth below nor to any product the exterior of which has been damaged or defaced, which has been subjected to misuse, abnormal service or handling, or which has been altered or modified in design or construction.

In order to enforce the rights under this limited warranty, the purchaser should follow the steps set forth below and provided proof of purchase to the servicer.

To the extent permitted by applicable state law, the warranties set forth herein are in lieu of, and exclusive of, all other warranties, express or implied. Specifically, ALL OTHER WARRANTIES OTHER THAN THOSE SET FORTH ABOVE ARE EXCLUDED. ALL EXPRESS AND IMPLIED WARRANTIES INCLUDING THE WARRANTIES OF MERCHANTABILITY, FITNESS FOR USE, AND FITNESS FOR A PARTICULAR PURPOSE ARE SPECIFICALLY EXCLUDED. If, under applicable state law, implied warranties may not validly be disclaimed or excluded, the duration of such implied warranties is limited to the period(s) from the date of purchase set forth below.

Neither the sales personnel of the seller nor any other person is authorized to make any warranties other than those described above, or to extend the duration of any warranties beyond the time period described above on behalf of Sharp.

The warranties described herein shall be the sole and exclusive warranties granted by Sharp and shall be the sole and exclusive remedy available to the purchaser. Correction of defects, in the manner and for the period of time described herein, shall constitute complete fulfillment of all liabilities and responsibilities of Sharp to the purchaser with respect to the Product, and shall constitute full satisfaction of all claims, whether based on contact, negligence, strict liability or otherwise. In no event shall Sharp be liable, or in any way responsible, for any damages or defects in the Product which were caused by repairs or attempted repairs performed by anyone other than an authorized servicer. Nor shall Sharp be liable or in any way responsible for any incidental or consequential economic or property damage. Some states do not allow limits on warranties or on remedies for breach in certain transactions; in such state the limits herein may not apply.

Your Product:

Personal Facsimile

Warranty Period for this Product:

Ninety (90) days parts and labor from date of purchase.

Additional items excluded from warranty coverage:

Any consumable items such as paper supplied with the Product.

Where to obtain service:

At a Sharp Authorized Servicer located in the United States. To find out the location of the nearest Sharp Authorized Servicer, call Sharp toll free at 1--800-BE-SHARP.

What to do to obtain service:

Ship (prepaid) or carry in your Product to a Sharp Authorized Servicer. Be sure to have proof of purchase available. If you ship or mail the Product, be sure it is packaged carefully.

For product information or customer assistance, please visit <http://www.sharp-usa.com> on the World Wide Web or call **1-800-BE SHARP**.

## SHARP ELECTRONICS CORPORATION

Sharp Plaza,

Mahwah, New Jersey 07430-2135

**SHARP®**

**SHARP ELECTRONICS CORPORATION**

**Sharp Plaza, Mahwah, New Jersey 07430-2135**

**SHARP CORPORATION**

PRINTED IN THAILAND  
(TINSE3912XH2B)