

SHARP®

MODEL 型號

香港電器安全規格
(國際電工委員會規格適合)

FO-A660

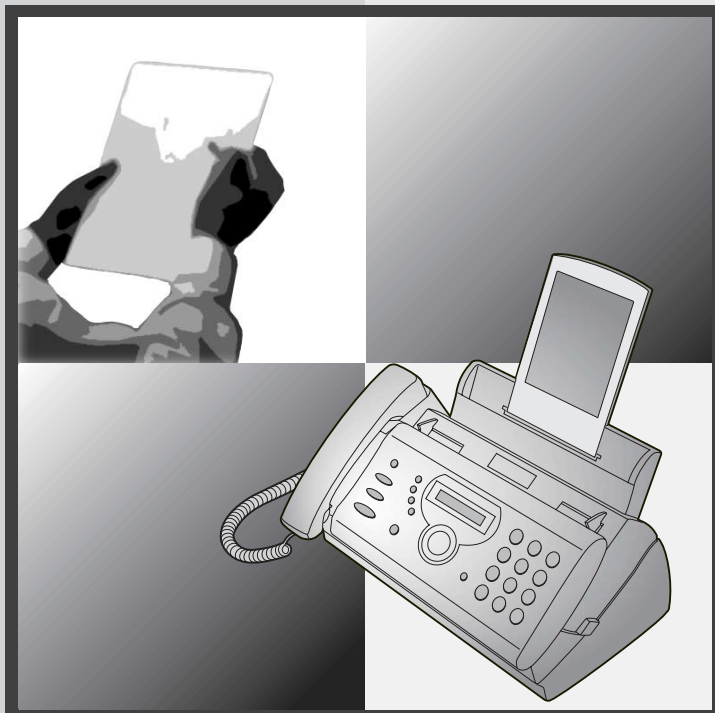

FACSIMILE
OPERATION MANUAL

傳真機
操作手冊

1. Installation
2. Using the Answering Machine
3. Sending Faxes
4. Receiving Faxes
5. Making Copies
6. Special Functions
7. Printing Lists
8. Maintenance
9. Troubleshooting

1. 安裝
2. 使用留言機
3. 傳送傳真
4. 接收傳真
5. 複印
6. 特殊功能
7. 打印清單
8. 維護
9. 故障排除

Introduction

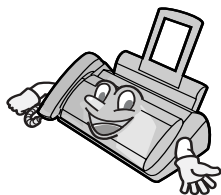

Welcome, and thank you for choosing a Sharp fax machine! The features and specifications of your new Sharp fax are shown below.

Automatic dialling	40 numbers
Imaging film	Initial starter roll (included with machine): 50 m (approx. 150 A4 pages) Replacement roll (not included): FO-9CR 60 m (one roll yields approx. 180 A4 pages)
Memory size*	448 KB (approx. 24 average pages with no voice messages recorded, or 20 minutes of voice messages (including OGMs) with no documents in memory)
Modem speed	14,400 bps with automatic fallback to lower speeds.
Transmission time*	Approx. 6 seconds (only when ECM is on)
Resolution	Horizontal: 8 pels/mm Vertical: Standard: 3.85 lines/mm Fine /Halftone: 7.7 lines/mm Super fine: 15.4 lines/mm
Automatic document feeder	10 pages max. (A4, 80 g/m ² paper)
Recording system	Thermal transfer recording
Halftone (grayscale)	64 levels
Compression scheme	MR, MH, MMR
Paper tray capacity (60 - 80 g/m² paper)	Approx. 50 A4-size sheets (at room temperature; maximum stack height should not be higher than the line on the tray)

*Based on Sharp Standard Chart at standard resolution, excluding time for protocol signals (i.e., ITU-T phase C time only).

Display	16-digit LCD display
Applicable telephone line	Public switched telephone network
Compatibility	ITU-T (CCITT) G3 mode
Input document size	Automatic feeding: Width: 148 to 216 mm Length: 140 to 297 mm Manual feeding: Width: 148 to 216 mm Length: 140 to 600 mm
Effective scanning width	210 mm max.
Effective printing width	204 mm max.
Contrast control	Automatic/Dark selectable
Reception modes	TEL/FAX, TEL, FAX, A.M.
Copy function	Single / Multi (99 copies/page)
Telephone function	Yes (cannot be used if power fails)
Power requirements	220-240 V AC, 50/60 Hz
Operating temperature	5 - 35°C
Humidity	25 - 85% RH
Power consumption	Standby: 2.5 W Maximum: 110 W
Dimensions (without attachments)	Width: 327 mm Depth: 193 mm Height: 163 mm
Weight (without attachments)	Approx. 2.8 kg

As a part of our policy of continuous improvement, SHARP reserves the right to make design and specification changes for product improvement without prior notice. The performance specification figures indicated are nominal values of production units. There may be some deviations from these values in individual units.

Important safety information

Do not disassemble this machine or attempt any procedures not described in this manual. Refer all servicing to qualified service personnel.

Do not install or use the machine near water, or when you are wet. For example, do not use the machine near a bath tub, wash bowl, kitchen sink or laundry tub, in a wet basement, or near a swimming pool. Take care not to spill any liquids on the machine.

Unplug the machine from the telephone socket and then the power outlet and consult a qualified service representative if any of the following situations occur:

- Liquid has been spilled into the machine or the machine has been exposed to rain or water.
- The machine produces odors, smoke, or unusual noises.
- The power cord is frayed or damaged.
- The machine has been dropped or the housing damaged.

Do not allow anything to rest on the power cord, and do not install the machine where people may walk on the power cord.

This machine must only be connected to a 220-240 V, 50/60 Hz, earthed (3-prong) outlet. Connecting it to any other kind of outlet will damage the machine.

Never insert objects of any kind into slots or openings on the machine. This could create a risk of fire or electric shock. If an object falls into the machine that you cannot remove, unplug the machine and consult a qualified service representative.

Do not place this machine on an unstable cart, stand or table. The machine could be seriously damaged if it falls.

Never install telephone wiring during a lightning storm.

Never install telephone sockets in wet locations unless the socket is specifically designed for wet locations.

Never touch bare telephone wires or terminals unless the telephone line has been disconnected at the network interface.

Use caution when installing or modifying telephone lines.

Avoid using a telephone (other than a cordless type) during an electrical storm. There may be a remote risk of electric shock from lightning.

Do not use a telephone to report a gas leak in the vicinity of the leak.

The power outlet must be installed near the equipment and must be easily accessible.

Table of Contents

A Look at the Operation Panel	6
<hr/>	
1. Installation	9
<hr/>	
Unpacking Checklist	9
Connections	10
Loading the Imaging Film	14
Loading Printing Paper	16
Entering Your Name and Fax Number	18
Setting the Date and Time	20
Setting the Reception Mode	22
Volume Adjustment	23
2. Using the Answering Machine	25
<hr/>	
Recording an Outgoing Message	25
Operating the Answering Machine	26
Optional Answering Machine Settings	30
Transfer Function	32
Override Ringing	35
Remote Operations	37
3. Sending Faxes	43
<hr/>	
Transmittable Documents	43
Loading the Document	44
Adjusting the Resolution and Contrast	45
Sending a Fax by Normal Dialling	47
Sending a Fax by Automatic Dialling	48
Sending a Fax From Memory	55
4. Receiving Faxes	57
<hr/>	
Using TEL/FAX Mode	57
Using A.M. Mode	58
Using FAX Mode	59
Using TEL Mode	60
Optional Reception Settings	62
Substitute Reception to Memory	65

5. Making Copies	66
<hr/>	
6. Special Functions	68
<hr/>	
Caller ID (Requires Subscription to Service)	68
Duplex Ringing (Requires Subscription to Service)	73
Blocking Reception of Unwanted Faxes	74
Polling (Requesting a Fax Transmission)	75
7. Printing Lists	76
<hr/>	
8. Maintenance	80
<hr/>	
9. Troubleshooting	83
<hr/>	
Problems and Solutions	83
Messages and Signals	87
Clearing Paper Jams	90
Quick Reference Guide	92
<hr/>	
Index	93
<hr/>	

A Look at the Operation Panel

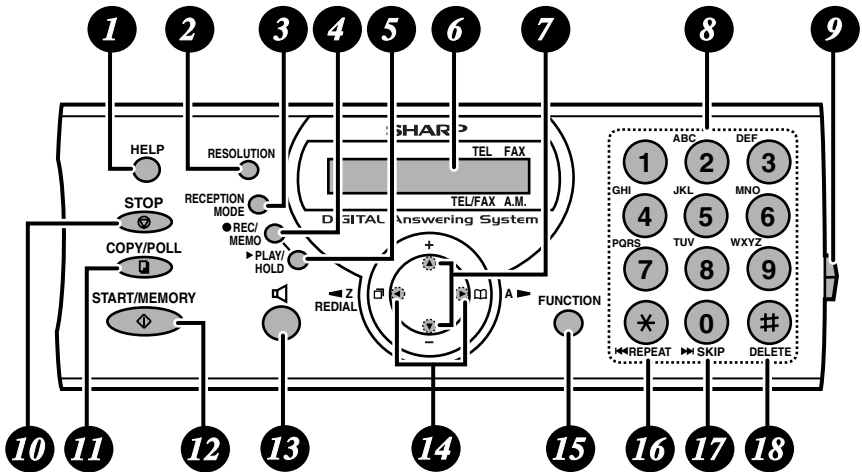

- 1 Help**
Press this key to print out the Help List, a quick reference guide to the operation of the fax machine.
- 2 RESOLUTION key**
Press this key to adjust the resolution for faxing or copying (page 45).
- 3 RECEPTION MODE key**
Press this key to select the reception mode (an arrow in the display will point to the currently selected reception mode; page 22).
- 4 REC/MEMO key**
Press this key to record an outgoing message, phone conversation, or memo (pages 25 and 29).
- 5 PLAY/HOLD key**
Press this key to play recorded messages (page 28), or to place a call on hold (page 62).
- 6 Display**
This displays messages and prompts to help you operate the machine.

- 7 UP and DOWN arrow keys**
Enlarge/reduce setting: When making a copy of a document, press these keys to select an enlarge/reduce setting (page 66).
Volume setting: When a document is not in the feeder, press these keys to change the speaker volume when the  key has been pressed, or the ringer volume at any other time (page 23).
FUNCTION key settings: Press these keys after pressing the **FUNCTION** key to scroll through the FUNCTION MODE settings.
- 8 Number keys**
Use these keys to dial numbers, and enter numbers and letters when storing auto-dial numbers.
- 9 Panel release**
Press this release to open the operation panel.
- 10 STOP key**
Press this key to cancel an operation before it is completed.
- 11 COPY/POLL key**
Press this key to make a copy of a document (page 66). This key is also used after dialling to poll (request fax transmission from) another machine (page 75).
- 12 START/MEMORY key**
Press this key after dialling to begin fax transmission (page 47). Press this key before dialling to send a fax through memory (page 55).
- 13 SPEAKER key**
Press this key to listen to the line and fax tones through the speaker when faxing a document (page 47).
- 14 Left and right arrow keys**
Auto-dial numbers: When sending a fax or making a phone call, press these keys to scroll through your auto-dial numbers (page 53), the "REVIEW CALLS" list (only available if you have Caller ID; page 69), and the last number dialled (redial; page 53).
FUNCTION key settings: Press the right arrow key after scrolling with the up and down arrow keys to select a **FUNCTION** key setting.
- 15 FUNCTION key**
Press this key followed by the arrow keys to select special functions and settings.

16

REPEAT key

Press this key while listening to a message to play it again (page 28).

17

SKIP key

Press this key while listening to a message to skip to the next message (page 28).



18

DELETE key

Press this key to erase recorded messages (page 29).

Monitoring phone conversations

When speaking through the handset, you can press  to allow a third person to listen to the conversation through the speaker. (To turn off the speaker, press the key again.)

To adjust the volume of the speaker when monitoring a conversation, press  or  (the volume reverts to the lowest setting each time the handset is replaced).

Note that **the speaker cannot be used for speaking**; it is only for listening.

To avoid feedback (a loud howling sound), be sure to turn off the speaker (press  once again) before you replace the handset.

1. Installation

Unpacking Checklist

Before setting up, make sure you have all of the following items.



If any are missing, contact your dealer or retailer.



Paper tray

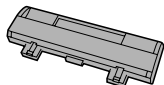

Handset



Paper tray extension

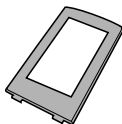

Handset cord

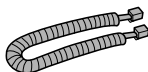

Operation manual

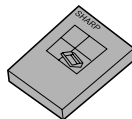

Telephone line cord



Gears (2)



Imaging film (initial starter roll)

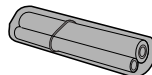

Points to keep in mind when setting up

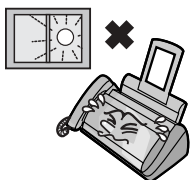

Do not place the machine in direct sunlight.

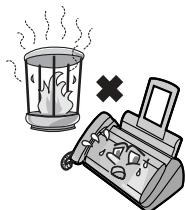

Do not place the machine near heaters or air conditioners.

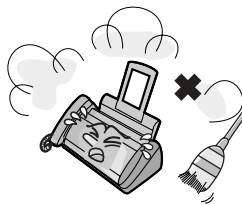

Keep dust away from the machine.

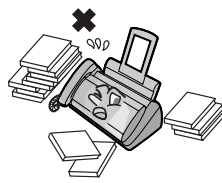

Keep the area around the machine clear.

About condensation

If the machine is moved from a cold to a warm place, it is possible that condensation may form on the scanning glass, preventing proper scanning of documents for transmission. To remove the condensation, turn on the power and wait approximately two hours before using the machine.

Connections

Connecting the handset

Connect the handset as shown and place it on the handset rest.

- ◆ The ends of the handset cord are identical, so they will go into either socket.

Make sure the handset cord goes into the socket marked with a handset symbol on the side of the machine!

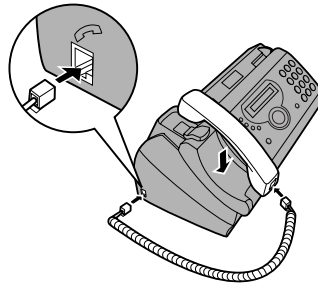
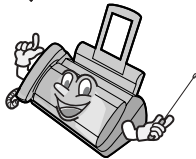

Use the handset to make ordinary phone calls, or to transmit and receive faxes manually.

Connecting the power cord

Plug the power cord into a 220-240 V, 50/60 Hz, earthed AC (3-prong) outlet.

- ◆ When disconnecting the fax, unplug the telephone line cord before unplugging the power cord.
- ◆ Caution: The power outlet must be installed near the equipment and must be easily accessible.

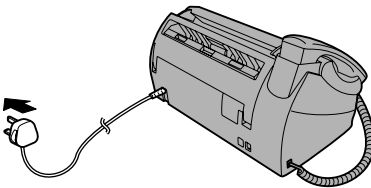

The machine does not have a power on/off switch, so the power is turned on and off by simply plugging in or unplugging the power cord.



Connecting the telephone line cord

Insert one end of the line cord into the socket on the back of the machine marked **TEL. LINE**. Insert the other end into a wall telephone socket.

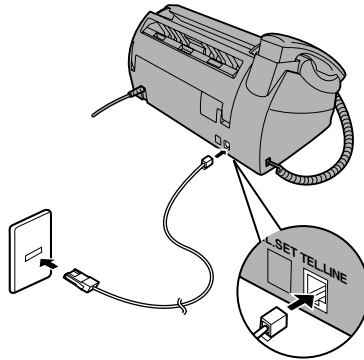



Setting the dial mode:

The fax machine is set for tone dialling. If you are on a pulse dial line, you must set the fax machine for pulse dialling. Press the keys on the operation panel as follows:

1 Press **FUNCTION**  once and  once.

Display:

OPTION SETTING 

2 Press  once and  3 times.

DIAL MODE 

3 Press  once.

1=TONE, 2=PULSE

4 Select the dial mode:

TONE:  PULSE: 

The display briefly shows your selection, then:

PSEUDO RING 

5 Press **STOP**  to exit.

Comments:

- ◆ The fax machine is not designed for use on a line which has call waiting, call forwarding, or certain other special services offered by your telephone company. If you attempt to use the fax machine in conjunction with any of these services, you may experience errors during transmission and reception of facsimile messages.
- ◆ The fax machine is not compatible with digital telephone systems.
- ◆ If your area experiences a high incidence of lightning or power surges, we recommend that you install surge protectors for the power and telephone lines. Surge protectors can be purchased from your dealer or at most telephone specialty stores.

Moving your fax and reconnecting

Should it be necessary to move your fax to a new location, first disconnect the telephone line cord before disconnecting the power lead. When reconnecting, it is necessary to connect the power lead before connecting the telephone line cord.

Attach the paper tray and paper tray extension

Attach the paper tray

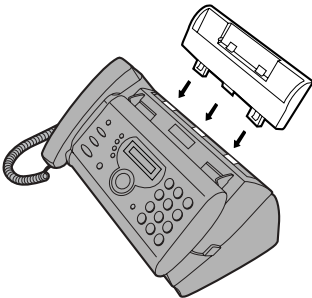

Attach the paper tray extension

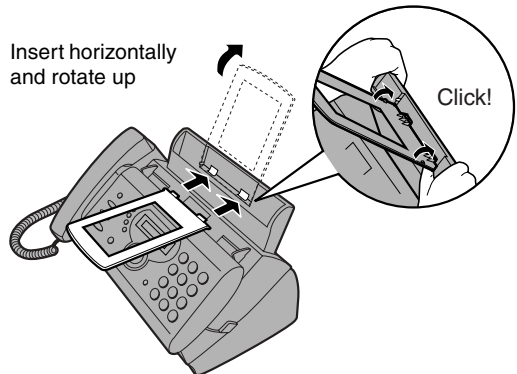

Note: The paper tray extension has a top side and a bottom side. If you cannot insert the tabs into the holes, turn the support over.

Extension phone (optional)

If desired, you can connect an extension phone to the **TEL. SET** socket on the fax.

- 1** Remove the seal covering the **TEL. SET** socket.

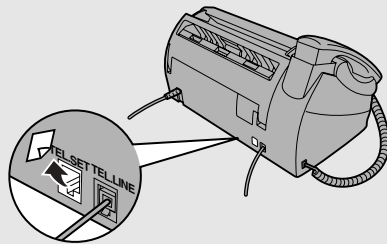

- 2** Connect the extension phone line to the **TEL. SET** socket.

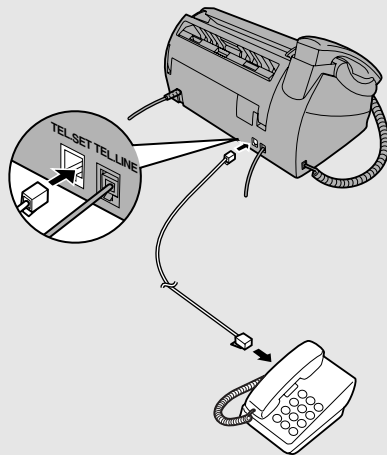

Loading the Imaging Film

Your fax uses a roll of imaging film to create printed text and images. The print head in the fax applies heat to the imaging film to transfer ink to the paper. Follow the steps below to load or replace the film.

The initial starter roll of imaging film included with your fax can print about 150 A4-size pages.



When replacing the film, use a roll of SHARP FO-9CR imaging film. One roll can print about 180 A4-size pages.

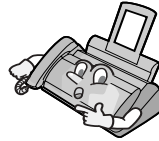

- 1** Remove the paper from the paper tray and open the operation panel (press **1**).

If you are loading the imaging film for the first time, go to Step 4.

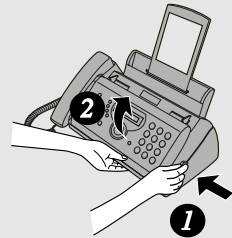

- 2** Remove the used film and empty spool.

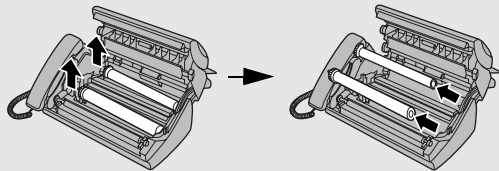

- 3** Remove the two green gears from the spools.
DO NOT DISCARD THE TWO GREEN GEARS!

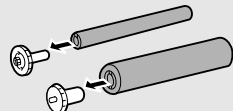

4 Remove the new roll of imaging film from its packaging.

- Cut the band that holds the rolls together.

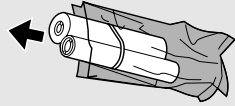

5 Insert the green gears.

Make sure the gears fit into the slots in the ends of the rolls.

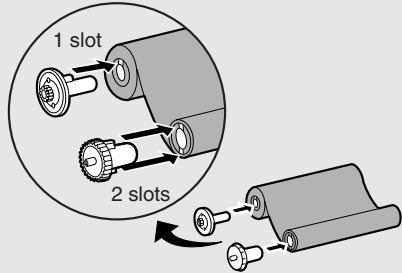

6 Insert the film into the print compartment.

Fit ends of rolls onto hubs

Thick roll to rear

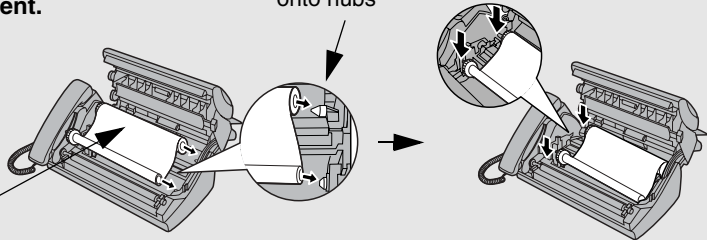

7 Rotate the front gear as shown until the film is taut.

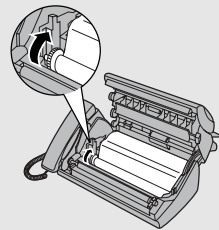

8 Close the operation panel (press down on both sides to make sure it clicks into place).

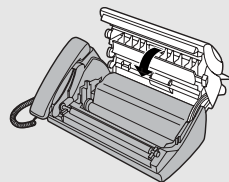

Loading Printing Paper

You can load up to 50 sheets of A4-size, 60 - 80 g/m² paper in the paper tray (at room temperature; maximum stack height should not be higher than the line on the tray).

- 1 Fan the paper, and then tap the edge against a flat surface to even the stack. Make sure the stack edges are even.**

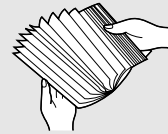

- 2 Insert the stack of paper into the tray, *PRINT SIDE DOWN*.**

- If paper remains in the tray, take it out and combine it into a single stack with the new paper.
- Be sure to load the paper so that printing takes place on the **print** side of the paper. Printing on the reverse side may result in poor print quality.
- **GENTLY LOAD PAPER INTO THE PAPER TRAY.**
- **DO NOT FORCE IT DOWN INTO THE FEED SLOT.**

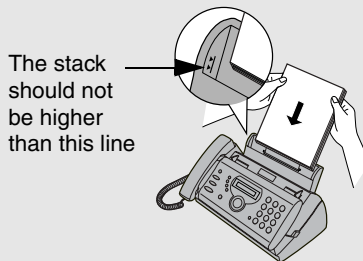

Note: Do not use paper that has already been printed on, or paper that is curled.

Note: If at any time the display shows the alternating messages at right, check the printing paper. If the tray is empty, add paper. If there is paper in the tray, take it out and then reinsert it.

When you are finished, press **START/MEMORY** .



ADD PAPER &



PRESS START KEY



Print contrast setting

Your fax has been set at the factory to print at normal contrast. If desired, you can change the print contrast setting to LIGHT.

1 Press  once and  once. Display: OPTION SETTING 

2 Press  once and  twice. PRINT CONTRAST 

3 Press  once. 1:NORMAL

4 Select the print contrast:
 NORMAL:  LIGHT:  The display briefly shows your selection, then: COPY CUT-OFF 

5 Press  to return to the date and time display.

Entering Your Name and Fax Number

Before you can begin sending faxes, you must enter your name and fax (telephone) number. You also need to set the date and time.

Once you enter this information, it will automatically appear at the top of each fax page you send.

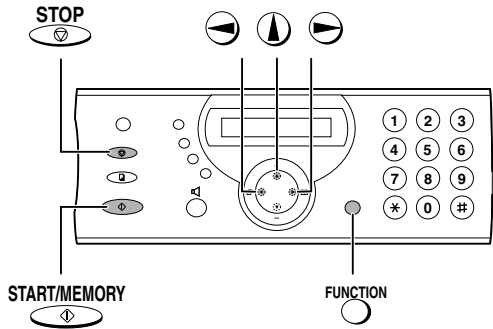

1 Press **FUNCTION** once and **▲** twice.

Display:

ENTRY MODE **↔**

2 Press **▶** once.

OWN NUMBER SET **↔**

3 Press **▶** once.

ENTER FAX #

4 Enter your fax number by pressing the number keys (max. 20 digits).



- To insert a space between digits, press **#**. To enter a "+", press *****.
- To clear a mistake, press .

5 Press  to enter the fax number in memory.

6 Enter your name by pressing number keys for each letter as shown in the chart below. Up to 24 characters can be entered.

Example: SHARP = 7777 44 2 777  7

SPACE = 1	G = 4	N = 6 6	U = 8 8
A = 2	H = 4 4	O = 6 6 6	V = 8 8 8
B = 2 2	I = 4 4 4	P = 7	W = 9
C = 2 2 2	J = 5	Q = 7 7	X = 9 9
D = 3	K = 5 5	R = 7 7 7	Y = 9 9 9
E = 3 3	L = 5 5 5	S = 7 7 7 7	Z = 9 9 9 9
F = 3 3 3	M = 6	T = 8	

- ◆ To enter two letters in succession that require the same key, press  after entering the first letter.
- ◆ To clear a mistake, press .
- ◆ To enter a lower case letter, continue pressing the key for the letter until the lower case letter appears. To enter one of the following symbols, press **#** or ***** repeatedly: . / ! " # \$ % & ' () * + , - ; < = > ? @ [¥] ^ _ ' { | } → ←

7 Press  to

Display:

DATE&TIME SET 

8 Press  to return to the date and time display.

Setting the Date and Time

The date and time appear in the display and are printed at the top of every page you fax. Set the date and time as shown below.

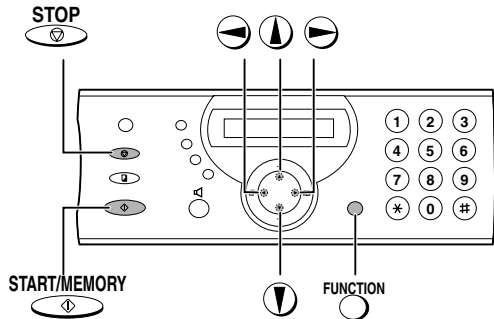
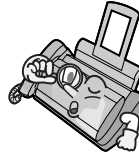

1 Press **FUNCTION** once and **▲** twice.

Display: ENTRY MODE **↔**

2 Press **▶** once and **▼** once.

DATE&TIME SET **↔**

3 Press **▶** once.

The currently set date appears (example):

DATE 15-08-2004

4 Enter a two-digit number for the day (“01” to “31”).

Example: the 5th 0 5



DATE 05-08-2004

- To correct a mistake, press **◀** to move the cursor back to the mistake and then enter the correct number.

- 5** Enter a two-digit number for the month (“01” for January, “02” for February, “12” for December, etc.).

Example: January 0 1 → DATE 05-01-2004

- 6** Enter the year (four digits).

The currently set time appears (example):

Example: 2004 2 0 0 4 → TIME 12:19

- 7** Enter a two-digit number for the hour (“00” to “23”) and a two-digit number for the minute (“00” to “59”).

Example: 9:25 0 9 2 5 → 05-JAN 09:25

- 8** Press **START/MEMORY**  to start the clock. → ANTI JUNK # 

- 9** Press **STOP**  to return to the date and time display.

Setting the Reception Mode

Your fax has four modes for receiving incoming faxes:

FAX mode:

Select this mode when you only want to receive faxes on your line. The fax machine will automatically answer all calls and receive incoming faxes.

TEL mode:

This mode is the most convenient for receiving phone calls. Faxes can also be received; however, all calls must first be answered by picking up the fax's handset or an extension phone connected to the same line.

TEL/FAX mode:

This mode is convenient for receiving both faxes and voice calls. When a call comes in, the fax will detect whether it is a voice call (including manually dialed faxes), or an automatically dialed fax. If it is a voice call, the fax will make a special ringing sound to alert you to answer. If it is an automatically dialed fax, reception will begin automatically.

A.M. mode:

Select this mode when you go out and want the built-in answering machine to answer all calls. Voice messages will be recorded, and fax messages will be received automatically.

Setting the reception mode

Press **RECEPTION MODE** until the arrow in the display points to the desired mode.

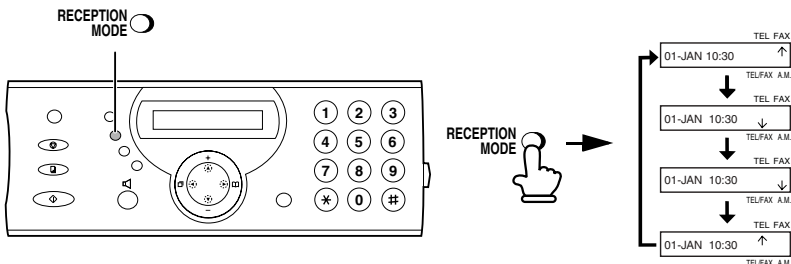

Note: A.M. mode cannot be selected unless a general outgoing message has been recorded as explained on page 25.

For more information on receiving faxes in TEL, TEL/FAX and FAX modes, see Chapter 4, *Receiving Faxes*. For more information on using A.M. mode, see Chapter 2, *Using the Answering Machine*.

Volume Adjustment

You can adjust the volume of the speaker and ringer using the up and down arrow keys.

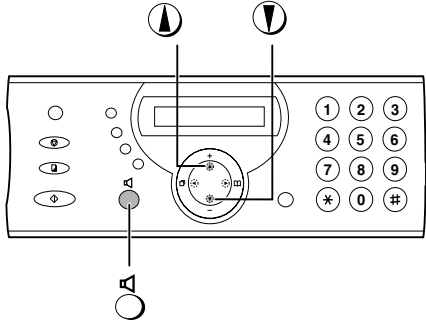

Speaker

1 Press 

2 Press  or  until the display shows the desired volume level.

- Press  again to turn off the speaker.

Ringer

1 Press  or .

(Make sure  has not been pressed and a document is not loaded in the feeder.)

- The ringer will ring once at the selected level, then the date and time will reappear in the display.

Display:

RINGER: HIGH



RINGER: MIDDLE



RINGER: LOW



RINGER: OFF OK ?

2 If you selected RINGER: OFF OK ?,

press .

Note: When the reception mode is set to TEL, the ringer will still ring at LOW if turned off.

2. Using the Answering Machine

The built-in answering machine allows you to receive both voice messages and faxes while you are out.



To use the answering machine, you will first need to record an outgoing message. When you go out, turn on the answering machine by setting the reception mode to A.M.

Recording an Outgoing Message

The outgoing message (OGM) is the greeting that the machine plays after answering a call to inform callers that they can leave a message or send a fax. Follow the steps below to record a message.

Example:

"Hello. You've reached _____. No one is available to take your call right now. Please leave a message after the beep or press your facsimile Start key to send a fax. Thank you for calling."

1 Press  once and  once.

Display:

OGM1(GENERAL) 

2 Press  once.

- If you have already recorded a message, you can press  to listen to the message.

LIFT HANDSET OR



PLAY: PLAYBACK

3 Lift the handset.



4 Press **START/MEMORY**  and speak into the handset to record a message.

- The outgoing message can be up to 60 seconds long. While recording, the display will show the time left to record.

5 When finished, replace the handset or press **STOP** .

To listen to the outgoing message

To listen to the outgoing message, follow Steps 1 and 2 of the above procedure and then press **PLAY/HOLD** . Note that the general outgoing message cannot be erased. If you need to change it, simply repeat the recording procedure.

Note: If an extension phone is connected to the fax machine, an outgoing message cannot be recorded, played, or deleted while the extension phone is being used.

Operating the Answering Machine

Activating the answering machine

To turn on the answering machine so that callers can leave messages, press

RECEPTION MODE  until the arrow in the display points to A.M.

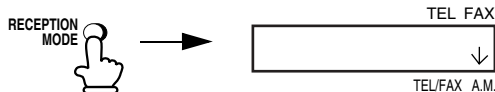

- ◆ The outgoing message will play (you can stop playback by pressing

STOP ).

- ◆ It will not be possible to set the reception mode to A.M. if an outgoing message has not been recorded.

Note: In A.M. mode, the machine will automatically switch to fax reception if it detects six seconds of silence after answering a call. For this reason, if a caller pauses for this length of time while leaving a message, they will be cut off.

Number of rings in A.M. mode (Toll Saver function)

The number of rings on which the machine answers incoming calls in A.M. mode depends on whether the Toll Saver function is turned on, and if it is on, whether you have messages.

- ◆ The Toll Saver function is initially turned on.

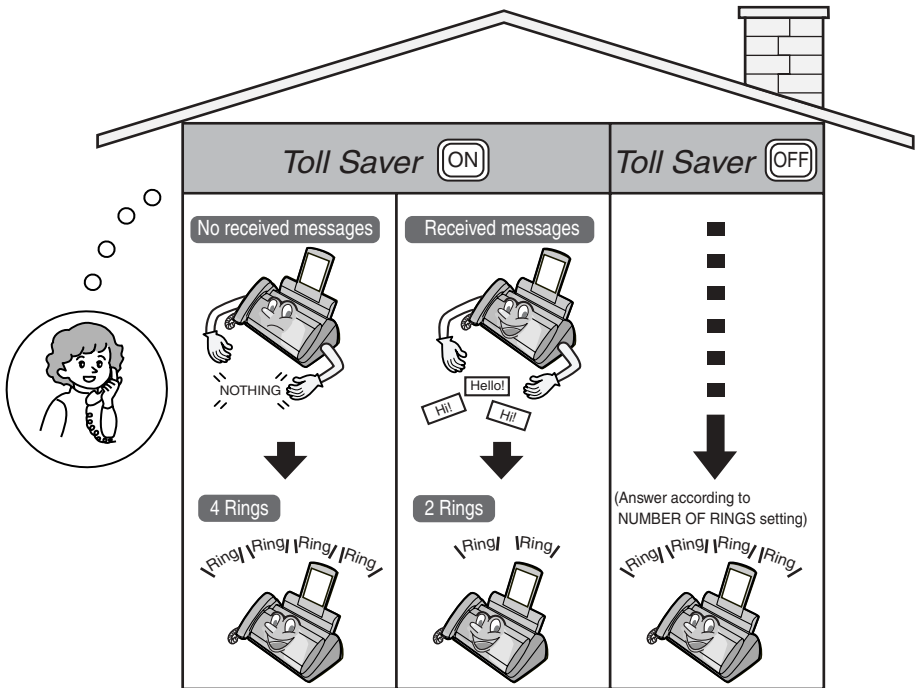

To turn off the Toll Saver function, see page 37.

To adjust the NUMBER OF RINGS setting, see page 59.



Listening to received messages

When you return, the display will show the number of messages recorded. Follow the steps below to listen to your messages.

1 Press .

- If you only want to listen to new messages (messages not previously listened to), continue to hold  down for at least two seconds.

2 The messages will play.





- As each message plays, the date and time of recording will appear briefly in the display. If no messages were received, NO MESSAGES will appear.
- **Repeat:** To listen to a message a second time, press  before playback of that message ends. To move back to the previous message, press  within 3 seconds of the beginning of the current message.
- **Skip:** To skip forward to the next message, press  .



Note: Playback will stop if you receive a call, lift the handset, or press  .

- ◆ You can print out a list of your received messages that shows the date and time that each was received. See page 76.

Erasing received messages

It is important to erase received messages after you listen to them to ensure that the memory does not become full.

◆ **Erasing all messages:** To erase all messages, press **FUNCTION** , **#** , and **DELETE** , then **START/MEMORY** .

◆ **Erasing a single message:** To erase a single message, press **#** , **DELETE**  while the message is being played.

Recording memos



You can record memos for yourself and other users of the machine. These will be played back together with incoming messages when the **▶PLAY/HOLD**  key is pressed.

1 Press **●REC/MEMO**  once and **▶**  once.

2 Pick up the handset, press **START/MEMORY** , and speak into the handset.

3 When you have finished speaking, replace the handset or press **STOP** .

Recording phone conversations (2-way recording)

To record a phone conversation, hold down the **●REC/MEMO**  key during the conversation you want to record. When you are finished, release the key. The conversation will be played back when the **▶PLAY/HOLD**  key is pressed.

Optional Answering Machine Settings



Setting ICM time

Incoming messages (ICMs) are the messages which callers leave for you on the built-in answering machine. The answering machine is set at the factory to allow each caller a maximum of 4 minutes to leave a message. If desired, you can change this setting to 15, 30, or 60 seconds.

1 Press  once and  once.

Display:

A.M. SETTING 

2 Press  once and  once.

RECORDINGTIME 

3 Press .

4 Press a number from 1 to 4 to select the desired ICM recording time.

1 15 seconds

3 60 seconds

2 30 seconds

4 4 minutes

The display briefly shows
your selection, then:

REMOTE CODE 

5 Press  to return to the date and time display.











Fax mode on A.M. failure

If the memory for recording incoming messages becomes full while you are out, the answering machine will no longer be able to record messages. The ON A.M. FAILURE setting is used to select whether or not the reception mode will switch to FAX mode when this happens:

- ◆ YES (switch to FAX mode): The reception mode will switch to FAX mode, allowing the machine to continue to receive faxes automatically. With this setting, you can still use the remote commands to listen to your messages and then erase them (see *Remote Operations* on page 37).







- ◆ **NO** (do not switch to FAX mode): The machine will answer after 20 rings, after which it will wait to receive a remote command. Most callers will hang up before it answers; however, when you call the machine from a remote location, you can wait until it answers, listen to your messages, and then erase them (see *Remote Operations* on page 37).

The initial setting is **NO** . If you want to change the setting to **YES**, press the panel keys as follows:

1 Press  once and  once.	Display: <div style="border: 1px solid black; padding: 2px; display: inline-block;">A.M. SETTING </div>
2 Press  once and  twice.	<div style="border: 1px solid black; padding: 2px; display: inline-block;">ON A.M. FAILURE </div>
3 Press  .	<div style="border: 1px solid black; padding: 2px; display: inline-block;">1=YES, 2=NO</div>
4 Press  to select YES (switch to FAX mode), or  to select NO .	The display briefly shows your selection, then: <div style="border: 1px solid black; padding: 2px; display: inline-block;">OGM ONLY MODE </div>
5 Press  to return to the date and time display.	



OGM only mode

If needed, you can turn off recording of incoming messages. In this case, your outgoing message will play, but callers will not be able to leave a message. (The machine will still receive faxes sent by automatic dialling.)

1 Press  once and  once.	Display: <div style="border: 1px solid black; padding: 2px; display: inline-block;">A.M. SETTING </div>
2 Press  once and  once.	<div style="border: 1px solid black; padding: 2px; display: inline-block;">OGM ONLY MODE </div>

3 Press  .

1=YES, 2=NO

4 Press  to turn on OGM only mode,
or  to turn it off.

The display briefly shows
your selection, then:

TOLL SAVER 

5 Press  to return to the date and time display.

Transfer Function



The Transfer function is used to have the machine automatically call you at a specified number every time it receives an incoming message. This lets you hear your messages immediately after they come in, even when you are at a remote location.

To use the Transfer function, you must first program the number that you wish the machine to call (the transfer number), and record the transfer message that plays when you answer the phone at the remote location.

When you go out and wish to use the transfer function, turn it on. When you return and no longer wish to use the transfer function, turn it off.



Programming the transfer number

To use the Transfer function, you must first give the machine the number to call (the transfer number).

1 Press  once and  once.

Display:

A.M. SETTING 

2 Press  once and  4 times.

TRANSFER TEL # 

3 Press  .

ENTER TEL #

4 Press the number keys to enter the transfer number.

- To insert a pause between any two digits of the number, press  .

5 Press  .**6 Press  to return to the date and time display.*****Recording the transfer message***



The transfer message plays when you answer the telephone, and informs you that the call is a transfer call. It can be up to 15 seconds long. To record a transfer message, follow the steps below. The following is an example:

“Hello. This is a transfer call for (YOUR NAME). Enter your remote code number now.”

1 Press  once and  twice.

Display:

OGM2(TRANSFER) **2 Press  once.**

- If you have already recorded a message, you can press  to listen to the message, or press  **DELETE** to delete the message.

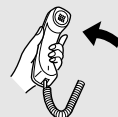

3 Lift the handset.

4 Press **START/MEMORY**  and speak into the handset to record the message.

- The transfer message can be up to 15 seconds long. While recording, the display will show the time left to record.

5 When finished, replace the handset or press **STOP** .

Checking or erasing the transfer message

To check or erase the transfer message, follow Steps 1 and 2 of the above procedure, and then press **▶PLAY/HOLD**  to check the message, or **#**  to erase the message.
DELETE



Turning the Transfer function on and off

When you go out and wish to use the Transfer function, turn it on as follows:

1 Press **FUNCTION**  once and  once.

Display:



A.M. SETTING 

2 Press  once and  3 times.

TRANSFER FUNC 

3 Press .

1=YES, 2=NO

4 Press **1**  to turn on the Transfer function.
(Press **2**  to turn the function off.)

The display briefly shows your selection, then:

ON A.M. FAILURE 

5 Press **STOP**  to return to the date and time display.

6 Each time the machine receives an incoming message, it will call your programmed transfer number. When you answer, you will hear your recorded message telling you that the call is a transfer call. On the dial pad of your phone, enter **#**, your remote code number (see page 37), and **#**. The machine will play back your messages.

- You can also perform any of the remote operations described in *Remote Operations* later in this chapter (see page 37).

Note: When you hang up after a transfer call, the machine will not immediately resume normal operation. If you want the machine to accept calls immediately after a transfer call, enter ***** twice before hanging up (if you want to hang up during message playback, first enter **0** and **#** to stop playback, then enter ***** twice).

Override Ringing

This function allows selected callers using a touch-tone telephone to override the answering machine's outgoing message and cause the machine to make a special ringing sound, alerting you that they are calling. This is useful when you are near the machine but only want to talk with certain callers, taking all other calls on the answering machine.

Programming the override code



To override the answering machine, your callers must enter a 3-digit override code from their telephone. This code has been set to "009" at the factory. If you wish to change the code, press the panel keys as shown below.

Important! Make sure the override code is different from the remote code used for remote operations.

1 Press **FUNCTION** once and **▼** once.

Display:



A.M. SETTING **↕**

2 Press  once and  3 times.

OVERRIDE CODE 

3 Press .

4 Press the number keys to enter a 3-digit override code.

5 Press  to store the override code, and then  to return to the date and time display.

Overriding the answering machine

Your callers should follow the steps below to override the answering machine.

1 The caller calls your machine from a touch-tone telephone. When the outgoing message begins, they should press the  key on their telephone.

- The caller will hear a short beep, and the outgoing message will stop.

2 The caller should enter the override code and  by pressing the appropriate keys on their telephone.

- If an incorrect code is entered, the caller will hear four beeps. He or she must re-enter the correct code within 10 seconds or the line will be disconnected.

3 Your machine will make a special ringing sound. Pick up the handset to answer the call. (Note that an extension telephone connected to the same line will not ring.)









- If you do not answer within 30 seconds, the outgoing message will play again and the caller can leave a message.

Remote Operations

When you are out, you can call the machine from any touch-tone telephone and play back your messages using the remote commands. You can also use these commands to change the reception mode and other settings.

Remote code number

To access the machine to perform remote operations, you must first enter your remote code number. The remote code number has been set to "001" at the factory. If you wish to use a different number, follow these steps:

1 Press  once and  once.	Display: <div style="border: 1px solid black; padding: 2px; display: inline-block;">A.M. SETTING </div>
2 Press  once and  twice.	<div style="border: 1px solid black; padding: 2px; display: inline-block;">REMOTE CODE </div>
3 Press  .	
4 Press the number keys to enter a 3-digit remote code number.	
5 Press  to store the remote number, and then  to return to the date and time display.	

Toll Saver

When you call the machine to listen to your messages, it will answer after 2 rings if it has received at least one message, or after 4 rings if it has not received any messages.

This allows you to save money on telephone charges, particularly if you are calling long distance. If the machine does not answer after the second ring, you can simply hang up before it answers, saving yourself the cost of that call.

If you do not want to use the Toll Saver function, you can turn it off by following the steps below. In this case, the machine will answer after the number of rings set with the NUMBER OF RINGS setting (see *Changing the number of rings* on page 59).

1 Press **FUNCTION** once and **▼** once.

Display:

A.M. SETTING ◀▶

2 Press **▶** once.

TOLL SAVER ◀▶

3 Press **▶** once.

1=YES, 2=NO

4 Press **①** to turn on the Toll Saver function, or **②** to turn it off.

The display briefly shows your selection, then:

RECORDING TIME ◀▶

5 Press **STOP** to return to the date and time display.

Retrieving your messages

1 Call the machine from a touch-tone telephone. When your outgoing message begins, press **Ⓝ** on the telephone.

- You will hear a short beep, and the outgoing message will stop.

2 Enter your remote code number and then press **Ⓝ**.

- You will hear a series of beeps equal to the number of messages recorded, or one long beep if four or more messages have been received. The machine will then play back the messages, beeping once at the end of each message. When all messages have been played back, you will hear a long beep.
- If no messages have been received, you will hear a short beep. You can either hang up, or perform any of the operations described in the following section, *Other remote operations*.

3 While the messages are playing, you can do any of the following:

- **Repeat:** To listen to a message a second time, press **2** and **#** on the telephone before that message ends. To move back to the previous message, press **2** and **#** during the first 3 seconds of the current message.
- **Skip forward:** To skip forward to the next message, press **5** and **#** on the telephone.
- **Stop:** To stop playback, press **0** and **#** on the telephone. After this, you can enter any of the commands described in the following section, *Other remote operations*.
- **Play new messages:** To listen to only your new messages, first stop playback by pressing **0** and **#**, and then press **6** and **#**.
- **Erase a message:** To erase the message you are currently listening to, press **3** and **#** before it ends.

4 When you have finished listening to your messages, you can do any of the following:

- **Erase all messages:** Press **3**, **3**, and **#**.
- **Repeat playback:** Press **7** and **#**.
- **Perform other operations:** You can enter any of the commands described in the following section, *Other remote operations*.
- **Hang up:** If you do not erase your messages first, they will be saved and any new messages will be recorded after them. If you want the machine to resume normal operation immediately, press ***** twice before hanging up (in some cases, particularly when the Transfer function is used, the machine may not accept new calls for one or two minutes after you hang up unless you press ***** twice).

Note: You can also call the machine and perform remote operations when the reception mode is set to FAX. In this case, when you call the machine, press

immediately after it answers (before you hear the fax tone), and then continue from Step 2 above.

Comments:

- ◆ When a remote command is accepted by the machine, you will hear one beep. If an incorrect command is entered, you will hear four beeps. In the latter case, re-enter the correct command.
- ◆ When entering a command, do not pause longer than 10 seconds between each digit. If you do, you will hear a 4-beep error signal and the digits entered up to that point will be cleared. In this case, re-enter the command from the beginning.
- ◆ If you pause for longer than 10 seconds before entering a command, or make two errors while entering your remote code number, the line will be disconnected. (This prevents unauthorized people from attempting to guess your remote code number.)

Other remote operations

After listening to your messages, you can perform any of the following operations by pressing the appropriate keys on the telephone.

Note: The following commands cannot be entered while messages are being played back. If you do not want to wait until playback ends to enter a command, first stop playback by pressing **0** and **#**, and then enter the command.

Changing the fax reception mode

Select a new reception mode by pressing the keys as follows:

◆ **A.M. mode:** **8**, **1**, and **#**.

◆ **FAX mode:** **8**, **2**, and **#**.

◆ **TEL mode:** **8**, **3**, and **#**.

Caution: If you select TEL mode, you will not be able to change the reception mode again.

◆ **TEL/FAX mode:** **8**, **4**, and **#**.

Recording a new outgoing message

1 Press **4** and ***** on the telephone.

2 When you hear a short beep, speak into the telephone to record the new message.

- The message can be up to 15 seconds long. After 15 seconds (or earlier if the machine detects silence after you finish speaking), you will hear a beep, and the new message will be played back.

Turning the Transfer function on or off

To turn Transfer on: Press **9**, **1**, and **#** on the telephone.

To turn Transfer off: Press **9**, **2**, and **#** on the telephone.

Changing the transfer telephone number

1 Press **9**, **0**, and **#** on the telephone.

2 After you hear a short beep, enter the new telephone number. When finished, press **#**.

- To insert a pause between any two digits of the number, press *****.

Recording a new transfer message

- 1** Press **9**, **3**, and **#** on the telephone.

- 2** When you hear a short beep, speak into the telephone to record the new message.
 - The time for the transfer message is fixed at 15 seconds. After 15 seconds (or earlier if the machine detects silence after you finish speaking), you will hear a beep, and the new message will be played back automatically.

Recording a memo

You can record a memo for yourself or other users of the machine. The memo will be played back when incoming messages are listened to.

- 1** Press ***** and **#** on the telephone.

- 2** When you hear a short beep, speak into the telephone to record the memo.

- 3** When you are finished, press **0** and **#** on the telephone.
 - If the machine detects silence, it will stop recording automatically.

OGM only mode

To turn on OGM only mode: Press **1**, **1**, and **#** on the telephone. (Your outgoing message will play, but callers will not be able to record a message. Faxes sent by automatic dialling will be received)



To turn off OGM only mode: Press **1**, **2**, and **#** on the telephone.

3. Sending Faxes

Transmittable Documents

Size and weight

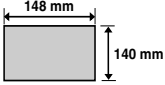
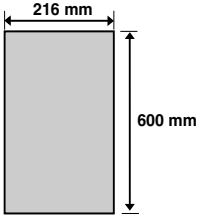
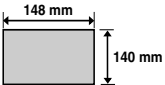
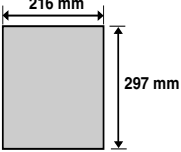
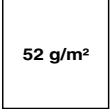
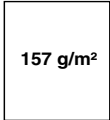
The size and weight of documents that you can load in the document feeder depend on whether you load one page at a time or several pages at once.

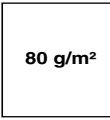
Loading one page at a time:		Loading up to 10 pages at once:	
Minimum size	Maximum size	Minimum size	Maximum size
			
Minimum weight	Maximum weight	Minimum weight	Maximum weight
			

Note: Letters or graphics on the edges of a document will not be scanned.

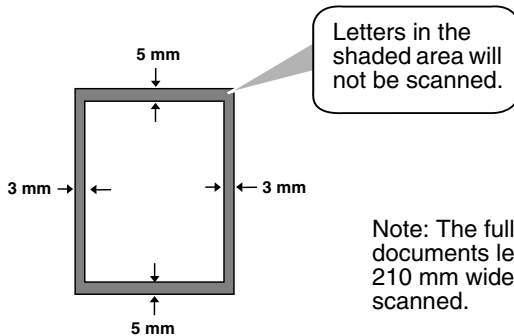

Note: The full width of documents less than 210 mm wide is scanned.

Other restrictions

- ◆ The scanner cannot recognise yellow, greenish yellow, or light blue ink.
- ◆ Ink, glue, and correcting fluid on documents must be dry before they pass through the document feeder.
- ◆ All clips, staples, and pins must be removed from documents before loading in the feeder. If these are not removed, they may damage the machine.
- ◆ Documents which are patched, taped, torn, smaller than the minimum size, carbon backed, easily smudged, or have a slippery coated surface should be photocopied, and the copy loaded in the feeder.

Loading the Document

Up to 10 pages can be placed in the feeder at one time. The pages will automatically feed into the machine starting from the bottom page.

- ◆ If you need to send or copy more than 10 pages, place the additional pages gently and carefully in the feeder just before the last page is scanned. Do not try to force them in, as this may cause double-feeding or jamming.
- ◆ If your document consists of several large or thick pages which must be loaded one at a time, insert each page into the feeder as the previous page is being scanned. Insert gently to prevent double-feeding.

-
- 1** Adjust the document guides to the width of your document.

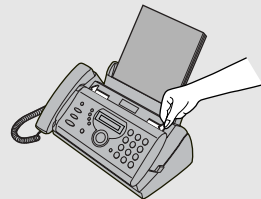

-
- 2** Insert the document face down in the document feeder. The top edge of the document should enter the feeder first.

- READY TO SEND will appear in the display.

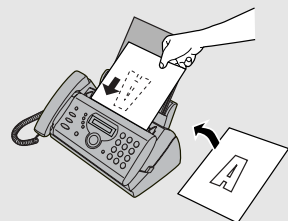

- 3** Adjust the resolution and/or contrast settings as explained in *Resolution and Contrast* below, then dial the receiving machine as explained on page 47.

Adjusting the Resolution and Contrast

If desired, you can adjust the resolution and contrast before sending a document.

The default resolution setting is STANDARD and the default contrast setting is AUTO.



You must adjust the settings each time you don't want to use the default settings.



Note: The resolution and contrast settings are only effective for sending a document. They are not effective for receiving a document.

Resolution settings

STANDARD	Use STANDARD for ordinary documents. This setting gives you the fastest and most economical transmission.
FINE	Use FINE for documents containing small letters or fine drawings.
SUPER FINE	Use SUPER FINE for documents containing very small letters or very fine drawings.
HALF TONE	Use HALF TONE for photographs and illustrations. The original will be reproduced in 64 shades of gray.

Contrast settings

- AUTO Use AUTO for normal documents.
- DARK Use DARK for faint documents.

1 Load the document(s).

- The document must be loaded before the resolution and contrast can be adjusted.

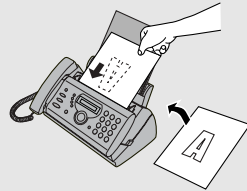

2 Press **RESOLUTION** one or more times until the desired resolution and contrast settings appear in the display.

- The first time you move through the list of resolution settings, the contrast setting AUTO will appear next to each resolution setting. The second time you move through the list, the contrast setting DARK will appear.

Display:

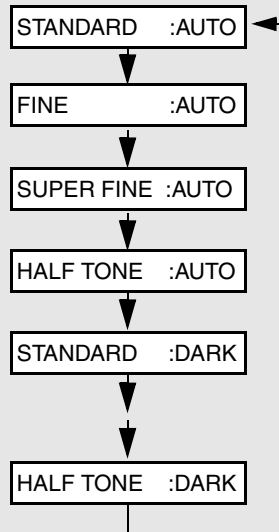

Note: In order to transmit in SUPER FINE resolution, the receiving fax machine must also have that resolution. If it doesn't, your machine will automatically step down to the next best available setting.

Sending a Fax by Normal Dialling

With Normal Dialling, you pick up the handset (or press ) and dial by pressing the number keys.

- ◆ If a person answers, you can talk with them through the handset before sending the fax. (If you pressed , you must pick up the handset to talk.)
- ◆ Normal Dialling allows you to listen to the line and make sure the other fax machine is responding.

1 Load the document(s).

- If desired, press  to set the resolution and/or contrast.

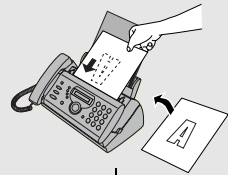

READY TO SEND

2 Pick up the handset or press . Listen for the dial tone.

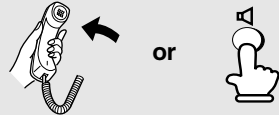

3 Dial the number of the receiving machine by pressing the number keys.



4 Wait for the connection. Depending on the setting of the receiving machine, you will either hear a fax tone or the other person will answer.

- If the other party answers, ask them to press their Start key (if you pressed , pick up the handset to speak with them). This causes the receiving machine to issue a fax tone.

5 When you hear the fax tone, press  . Replace the handset.



- If the transmission is completed successfully, the fax will beep once.
- If an error occurs, the fax will beep three times and print a Transaction Report to inform you of the problem (see page 78).

Note:

If the transmission is unsuccessful and DOCUMENT JAMMED appears in the display, remove the document as explained on page 90. (This may occur if the other fax machine doesn't respond properly when you attempt to send the document.)

Sending a Fax by Automatic Dialling

You can store up to 40 fax or phone numbers in the machine for automatic dialling.

- ◆ Auto-dial numbers are dialled by pressing  until the desired number appears in the display, and then  .

Storing fax and phone numbers for automatic dialling

1 Press  once and  once.



Display:

<NEW NUMBER> 

2 Press  once.

ENTER FAX #

3 Enter the fax or voice number by pressing the number keys. Up to 32 digits can be entered. (Note: A space cannot be entered.)

- To clear a mistake, press  .
- If a pause is required between any of the digits to access a special service or an outside line, press  . The pause appears as a hyphen (two seconds per pause). Several pauses can be entered in a row.

4 Press **START/MEMORY** 



5 Enter a name by pressing number keys for each letter as shown in the chart below. Up to 15 characters can be entered. (If you do not wish to enter a name, go directly to Step 6.)

Example: SHARP = 7777 44 2 777  7

SPACE = 1	G = 4	N = 6 6	U = 8 8
A = 2	H = 4 4	O = 6 6 6	V = 8 8 8
B = 2 2	I = 4 4 4	P = 7	W = 9
C = 2 2 2	J = 5	Q = 7 7	X = 9 9
D = 3	K = 5 5	R = 7 7 7	Y = 9 9 9
E = 3 3	L = 5 5 5	S = 7 7 7 7	Z = 9 9 9 9
F = 3 3 3	M = 6	T = 8	

◆ To enter two letters in succession that require the same key, press  after entering the first letter.

◆ To enter a lower case letter, continue pressing the key for the letter until the lower case letter appears. To enter one of the following symbols, press

 or  repeatedly: . / ! " # \$ % & ' () * + , - : ; < = > ? @ [¥] ^ _ ' { | } → ←

6 Press **START/MEMORY** 

Display:

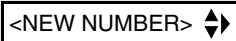



7 Return to Step 2 to store another number, or press  to return to the date and time display.

Note: The fax machine uses a lithium battery to keep automatic dialling numbers and other programmed information in memory when the power is turned off. Battery power is consumed primarily when the power is off. With the power kept continuously off, the life of the battery is about 5 years. If the battery dies, have your dealer or retailer replace it. Do not try to replace it yourself.



Editing and clearing auto-dial numbers

If you need to make changes to a previously stored auto-dial number, or clear a number, follow these steps:

1 Press  **once** and  **once.**

Display:

<NEW NUMBER> 

2 Press  or  until the number you wish to edit or clear appears in the display.

3 Press  **once.**



1=EDIT, 2=CLEAR

4 Select **EDIT** or **CLEAR**:

EDIT:  **CLEAR:** 



- If you selected **CLEAR**, go to Step 8.

5 If you selected **EDIT**, make the desired changes to the number.

- Press  or  to move the cursor to the digit or digits you wish to change, and then enter the new digit. The new digit will replace the old digit.
- If you do not wish to change the number, go directly to Step 6.

6 Press 

7 Make the desired changes to the name.

- Press  or  to move the cursor to the letter or letters you wish to change, and then press the appropriate number key repeatedly until the desired letter appears (see Step 5 on page 49). The new letter will replace the old letter.
- If you do not wish to change the name, go directly to Step 8.

8 Press **START/MEMORY** 

9 Return to Step 2 to edit or clear another number, or press **STOP**  to return to the date and time display.

Using an auto-dial number



Once you have stored a fax or phone number, you can use it to send a fax or make a phone call.

1 If you are sending a fax, load the document(s).

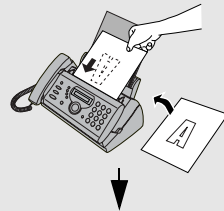
- If desired, press **RESOLUTION**  to set the resolution and/or contrast.



READY TO SEND

2 Press  (or ) until the name of the other party appears in the display (if no name was stored, the number will appear).

3 If you are sending a fax, press **START/MEMORY** . Dialling and transmission begins.

- If the transmission is completed successfully, the fax will beep once.
- If an error occurs, the fax will beep three times and print a Transaction Report to inform you of the problem (see page 78).

If you are making a phone call, lift the handset. Dialling begins.

Sending a fax by Direct Keypad Dialling

You can also enter a full number with the number keys and then press the **START/MEMORY**  key to begin dialling. You can use this method to dial a full number when you don't need to speak to the other party before faxing.

1 Load the document(s).

- If desired, press **RESOLUTION**  to set the resolution and/or contrast.

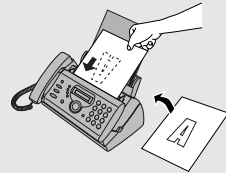

READY TO SEND

2 Enter the number of the receiving machine by pressing the number keys.

- If a pause is required between any of the digits to access a special service or an outside line, press **FUNCTION** . The pause will appear as a hyphen (two seconds per pause). Several pauses can be entered in a row.

3 Check the display. If the number of the receiving machine shown is correct, press **START/MEMORY .**

- If the number is not correct, press **STOP**  to backspace and clear one digit at a time, and then re-enter the correct digit(s).

Redial

You can automatically redial the last number dialled. This procedure can be used to send a fax or make a phone call.

1 If you are sending a fax, load the document(s).

- If desired, press  to set the resolution and/or contrast.

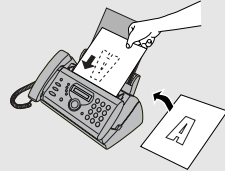

READY TO SEND

2 Press once. <REDIAL> appears in the display, followed by the last number dialled. Make sure the number that appears is the number you wish to dial.

3 If you are sending a fax, press . Dialling and transmission begins.

If you are making a phone call, lift the handset. Dialling begins.

Note:

If a fax transmission is unsuccessful and DOCUMENT JAMMED appears in the display, remove the document as explained on page 90. (This may occur if the other fax machine doesn't respond properly when you attempt to send the document.)

Automatic redialling

If you use automatic dialling (including Direct Keypad Dialling) to send a fax and the line is busy, the fax machine will automatically redial the number. The fax machine will make three redial attempts at an interval of five minutes. During this time, RECALLING will appear in the display, followed by a two-digit number assigned to the fax job. You will not be able to dial any other locations while the message appears.



Sending a Fax by Automatic Dialling

- ◆ To stop automatic redialling, press .
- ◆ Under certain conditions (for example if a person answers the call on a telephone), automatic redialling may stop before two redialling attempts are made.

Error Correction Mode



The fax machine is set to automatically correct any distortions in a transmission due to noise on the telephone line before printing at the receiving end. This function is called Error Correction Mode (ECM). ECM is effective for both transmissions and receptions, and is only effective when the other fax machine has ECM as well.

When there is considerable noise on the line, you may find that transmission with ECM turned on takes longer than normal. If you prefer a faster transmission time, you can try turning ECM off.

1 Press  **once** and  **once.**

Display:

OPTION SETTING 

2 Press  **once** and  **4 times.**

ECM MODE 

3 Press  **once.**

1=YES, 2=NO

4 Press  **to select YES, or**  **to select NO.**

The display briefly shows your selection, then:

RECEIVE RATIO 

5 Press  **to return to the date and time display.**

Sending a Fax From Memory

You can scan a document into the fax's memory and send the document from memory. This increases transmission speed and allows you to send a fax to multiple destinations in a single operation. After transmission, the document is automatically cleared from memory.

Broadcasting (sending a fax to multiple destinations)

This function allows you to send the same fax to as many as 20 different locations in just one operation.

- ◆ When sending to multiple locations, only auto-dial numbers can be used to dial the numbers of the receiving machines.

1 Load the document(s).

- If desired, press **RESOLUTION**  to set the resolution and/or contrast.

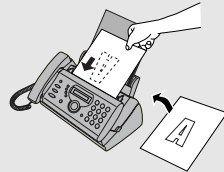



2 Press **START/MEMORY**

3 Press (or) until the name of the number appears in the display (if no name was stored, the number will appear).

4 Press to select the number.

5 Repeat Steps 3 and 4 for each of the other locations to which you wish to send the fax (maximum of 20).

- To check your selected locations, press  to scroll through them. To delete a location, scroll to the location and then press **STOP** .





6 When you are ready to begin transmission, press  .

- A Transaction Report is automatically printed out after Broadcasting is completed. Check the "Note" column of the report to see if any of the locations are marked "Busy" or have a communication error code. If so, send the document to those locations again.

Memory transmission



You can also send a fax through memory when sending to a single location. This is convenient when sending to locations where the line is often busy, as it saves you from waiting to pick up the original document and frees the feeder for other operations.

To send a fax through memory, load the document, press  , and then dial using one of the following methods:

- ◆ Press the number keys to enter the fax number and then press  .
- ◆ Press  repeatedly to select an auto-dial number and press  .
- ◆ Press  once to select the last number dialled and press  .

If the memory becomes full...

If the memory becomes full while the document is being scanned, MEMORY IS FULL and SEE MANUAL will alternately appear in the display.

- ◆ Press  if you want to transmit the pages which have been stored up to that point in memory. The remaining pages will be ejected from the feeder. After transmission, the memory will be cleared and you can transmit the remaining pages. You will also need to transmit the page which was being scanned when the memory filled up.
- ◆ Press  if you want to cancel the entire transmission.

4. Receiving Faxes

Using TEL/FAX Mode

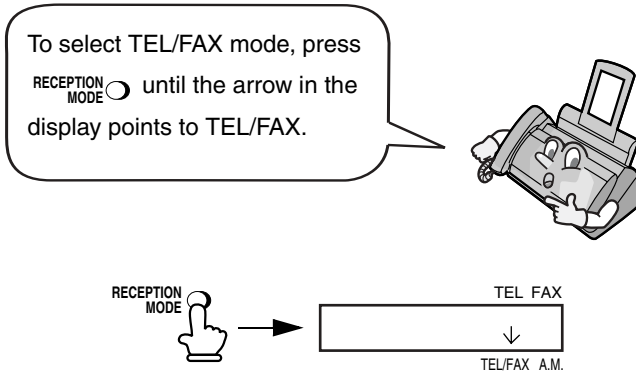

When the reception mode is set to TEL/FAX, your fax machine automatically answers all calls on two rings. After answering, your fax monitors the line for about five seconds to see if a fax tone is being sent.

- ◆ If your fax machine detects a fax tone (this means that the call is an automatically dialed fax), it will automatically begin reception of the incoming document.
- ◆ If your fax machine doesn't detect a fax tone (this means that the call is a voice call or manually dialed fax), it will make a ringing sound (called pseudo ringing) for 15 seconds to alert you to answer. If you don't answer within this time, your fax will send a fax tone to the other machine to allow the calling party to send a fax manually if they desire.

Note: Only the fax will alert you to voice calls or manually dialed faxes by pseudo ringing. An extension phone connected to the same line will not ring after the connection has been established.



Pseudo Ring Duration for Tel/Fax Mode

If desired, you can change the duration of pseudo ringing in Tel/Fax mode.

1 Press **FUNCTION**  once and  once.

Display:

OPTION SETTING 

2 Press  once and  4 times.

PSEUDO RING 

3 Press  once.

1=15 SECONDS

4 Enter a number as follows for the desired duration:

- ① 15 SECONDS
- ② 30 SECONDS
- ③ 60 SECONDS
- ④ 120 SECONDS

The display briefly shows your selection, then:

DUPLEX RINGING 

5 Press  to return to the date and time display.

Using A.M. Mode

To select A.M. mode, press  until the arrow in the display points to A.M.

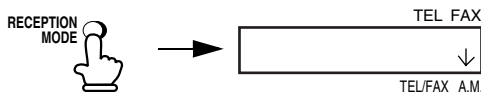

In A.M. mode, your fax machine will automatically receive voice messages and faxes. See Chapter 2 for more details.

Using FAX Mode

To select FAX mode, press
RECEPTION MODE  until the arrow in
the display points to FAX.

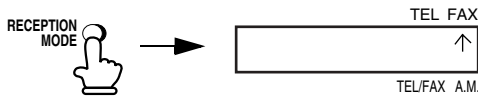

When the reception mode is set to FAX, the fax machine will automatically answer all calls on two rings and receive incoming faxes.

- ◆ If you pick up the handset before the machine answers, you can talk to the other party and/or receive a fax as explained in *Using TEL Mode* on page 60.

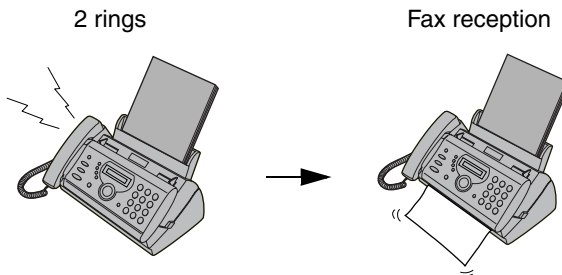

Changing the number of rings

If desired, you can change the number of rings on which the fax machine answers incoming calls in FAX and TEL/FAX mode. Any number from 2 to 5 can be selected.

1 Press **FUNCTION**  once and  once.

Display:

OPTION SETTING 

2 Press  once.

NUMBER OF RING 

3 Press  once.

ENTER (2-5) (2)

4 Enter the desired number of rings (any number from 2 to 5).

The display briefly shows your selection, then:

Example: 3 rings 

FAX REMOTE # 

5 Press  to return to the date and time display.

Using TEL Mode



To select TEL mode, press RECEPTION MODE  until the arrow in the display points to TEL.

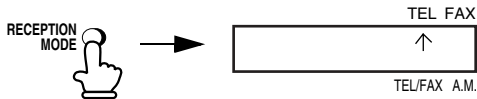

When the reception mode is set to TEL, you must answer all calls by picking up the fax machine's handset or an extension phone connected to the same line.

Answering with the fax's handset

- 1** When the fax machine rings, pick up the handset.

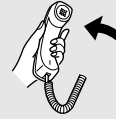

- 2** If you hear a fax tone, wait until the display shows RECEIVING and then replace the handset.



RECEIVING

Note: If you have set the Fax Signal Receive setting (page 62) to NO, press **START/MEMORY**  to begin reception.

- 3** If the other party first speaks with you and then wants to send a fax, press **START/MEMORY**  after speaking. (Press before the sender presses their Start key.)

START/MEMORY 

RECEIVING

- When RECEIVING appears in the display, hang up.



Answering on an extension phone

- 1** Answer the extension phone when it rings.



- 2** If you hear a soft fax tone, wait until your fax responds (the extension phone will go dead), then hang up.





Phone goes dead



3 If the fax doesn't respond, or if the other party first talks to you and then wants to send a fax, press **5** once and ***** twice on the extension phone (only on a tone dial phone). This signals the fax to begin reception. Hang up.

- The above step is necessary if you have set the Fax Signal Receive setting (see below) to NO.
- Your fax will not accept the signal to begin reception (5***) if a document is loaded in its feeder.

Putting a call on hold

To put the other party on hold during a phone conversation, press **▶PLAY/HOLD**  . When this is done, they cannot hear you. You can put the handset back in the cradle without breaking the connection. When you are ready to speak with the other party again, pick up the handset. If you did not put the handset back in the cradle, press **▶PLAY/HOLD**  again to resume conversation.

Optional Reception Settings



Fax Signal Receive

Your fax will automatically begin reception if you hear a soft fax tone after answering a call on your fax or an extension phone. If you use a computer fax modem to send documents on the same line, you must turn this function off in order to prevent your fax from mistakenly attempting to receive documents from the computer fax modem. Follow the steps below to change the setting.

1 Press **FUNCTION**  once and  once.

Display:



OPTION SETTING 

2 Press  once and  6 times.

FAX SIGNAL RX 

3 Press  once.

1=YES, 2=NO

4 Press  to turn on the function, or
 to turn it off.

The display briefly shows your selection, then:

CALLER-ID 

5 Press  to return to the date and time display.



Changing the number for remote fax activation

If desired, you can use a number other than **5** to activate fax reception from an extension telephone. You can select any number from **0** to **9**.

1 Press  once and  once.

Display:

OPTION SETTING 

2 Press  once and  once.

FAX REMOTE # 

3 Press  once.

ENTER (0-9) (5)

4 Enter the desired number (any number from 0 to 9).

The display briefly shows your selection, then:

Example: 3 

TRANSACTION 

5 Press  to return to the date and time display.

Reception Ratio

The fax has been set at the factory to automatically reduce the size of received documents to fit the size of the printing paper. This ensures that data on the edges of the document are not cut off. If desired, you can turn this function off and have received documents printed at full size.

- ◆ If a document is too long to fit on the printing paper, the remainder will be printed on a second page. In this case, the cut-off point may occur in the middle of a line.
- ◆ Automatic reduction may not be possible if the received document is too large, contains too many fine graphics or images, or is sent at high resolution. In this case, the remainder of the document will be printed on a second page.

1 Press **FUNCTION** once and **▲** once.

Display:

OPTION SETTING ↕

2 Press **▶** once and **▲** 3 times.

RECEIVE RATIO ↕

3 Press **▶** once.

1=AUTO, 2=100%

4 Press **1** to select AUTO, or **2** to select 100%.

The display briefly shows your selection, then:

PRINT CONTRAST ↕

5 Press **STOP** to return to the date and time display.

Substitute Reception to Memory

In situations where printing is not possible, such as when your fax runs out of paper, the imaging film needs replacement, or the paper jams, incoming faxes will be received to memory.

When you have received a document in memory, FAX RX IN MEMORY will appear in the display, alternating with ADD PAPER & PRESS START KEY or CHECK FILM / CHECK COVER / CHECK PAPER JAM. When you add paper (and press , replace the imaging film, or clear the jam, the stored documents will automatically print out.

The machine will retain any received faxes in memory until printed, even if the power cord is unplugged or a power failure occurs.

5. Making Copies

Your fax machine can also be used to make copies. Single and multiple copies (up to 99 per original) can be made, enabling your fax to double as a convenience office copier.

1 Load the document(s) face down. (Maximum of 10 pages.)

- If desired, press **RESOLUTION** to set the resolution and/or contrast. (The default resolution setting for copying is FINE.)

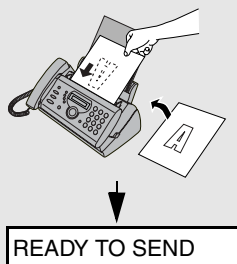

2 If desired, select an enlarge/reduce setting, and/or select the number of copies per original:

- ENLARGE/REDUCE: Press **▲** or **▼** until the desired setting appears in the display. Settings are 100%, 125%, 135%, 50%, 73%, 88%, 94%, and AUTO. (The default setting is 100%.)

Example: Press **▲** twice → **RATIO: 125%**

- Number of copies per original: Press the number keys to enter a number from 1 to 99. (The default setting is 1.)

Example: Press **5** for five copies → **5**

3 When you are ready to begin copying, press **COPY/POLL**.

If MEMORY IS FULL appears...

If the memory becomes full while a document is being scanned, MEMORY IS FULL and SEE MANUAL will alternately appear in the display and the document will automatically feed out. This may happen if the resolution is set to SUPER FINE, or if you selected an enlarge/reduce setting, or if you are making more than one copy per original. To avoid using memory, use STANDARD or FINE for the resolution, 100% for the enlarge/reduce setting, and make only one copy per original.

Copy Cut-off

When making a copy of a document that is longer than the printing paper, use the copy cut-off setting to select whether the remaining part of the document will be cut off or printed on a second page. The initial setting is YES (cut off the remainder). To change the setting, follow the steps below.

1 Press **FUNCTION** once and **▲** once.

Display:

OPTION SETTING 

2 Press **▶** once and **▲** once.

COPY CUT-OFF 

3 Press **▶** once.

1=YES, 2=NO

4 Press **①** to set copy cut-off to YES (the remaining part of the document will not be printed), or **②** to set copy cut-off to NO (the remaining part will be printed on a second page).

The display briefly shows your selection, then:

NUMBER OF RING 

5 Press **STOP** to return to the date and time display.



6. Special Functions

Caller ID (Requires Subscription to Service)

If you subscribe to a caller identification service from your telephone company, you can set your fax machine to display the name and number of the caller while the fax rings.



Important:

- ◆ To use this function, you must subscribe to a caller identification service from your telephone company.
- ◆ Your fax may not be compatible with some caller identification services.

1 Press  once and  once.

Display:

OPTION SETTING 

2 Press  once and  5 times.

CALLER-ID 

3 Press  once.

1=YES, 2=NO

4 Press  (YES) to turn on Caller ID.

(To turn off Caller ID, press )

The display briefly shows your selection, then:

ECM MODE 

5 Press  to return to the date and time display.

How Caller ID operates

When you receive a call, the name and phone number of the caller will alternately appear in the display, beginning just before the second ring. The information will continue to be displayed until the line is disconnected.

Note: Some caller ID services may not provide the name of the caller. In this case, only the phone number will appear.

Display example

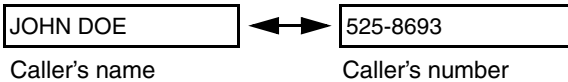

Display messages

One of the following messages will appear while the fax rings if caller information is not available.

NO SERVICE	No caller information was received from your telephone company. Make sure that the telephone company has activated your service.
CALLER-ID ERROR	Noise on the telephone line prevented reception of caller information.
OUT OF AREA	The call was made from an area which does not have a caller identification service, or the caller's service is not compatible with that of your local phone company.
PRIVATE CALL	Caller information was not provided by the telephone company at the caller's request.

Viewing the Caller ID list

If you subscribe to a Caller ID service and have turned on the Caller ID function, your fax machine will keep information on the most recent 30 calls and faxes you have received. You can view this information, which consists of the name and number of each caller, in the Caller ID List.



- ◆ After you have received 30 calls, each new call will delete the oldest call.
- ◆ All calls will be erased if you unplug the fax or a power failure occurs.

Caller ID (Requires Subscription to Service)

Follow the steps below to view the Caller ID List in the display. If desired, you can immediately dial a number when it appears.

1 Press  twice.



<REVIEW CALLS> 

2 Press  or  to scroll through the list.

3 If you want to dial one of the numbers in the list, scroll through the list until the number appears in the display.

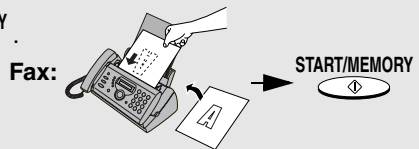
- **Fax:** If you want to send a fax, load the document and then press . Dialling and transmission begin.





- **Voice call:** If you want to make a voice call, pick up the handset (or press ). Dialling begins automatically. (If you pressed , pick up the handset when the other party answers.)



4 Press  when you have finished viewing the list.

To delete calls from the Caller ID list



If you want to delete a single call from the caller list, press  while the call appears in the display. If you want to delete all calls from the list, hold

 down for at least 3 seconds while you are viewing any number in the list.

Priority Call



With Caller ID turned on, you can set your fax to make a special ringing sound when you receive a call from a designated phone number. This lets you know immediately who is calling without having to look at the display.

To use this function, enter the desired phone number by following the steps below (only one phone number can be entered).



1 Press  once and  twice. Display: ENTRY MODE 

2 Press  once and  once. PRIORITY # 

3 Press  once. 1=SET, 2=CLEAR

4 Press  to store a number.
(To clear a previously stored number, press  and go to Step 6.)

5 Enter the number by pressing the number keys (max. 20 digits).

6 Press  to store (or clear) the number. OWN NUMBER SET 

7 Press  to return to the date and time display.

Blocking voice calls

With Caller ID turned on, you can use the Anti Junk Fax function described in *Blocking Reception of Unwanted Faxes* in this chapter to block voice calls as well as faxes from your specified Anti Junk Number.

In this case, when a voice call or a fax transmission comes in from a number you have specified as a "Junk Number", your fax will break the connection as soon as it receives the calling phone number from the caller ID service (before the second ring).

To use this function, enter the number that you wish to block as explained in *Blocking Reception of Unwanted Faxes* (see page 74). Only one number can be blocked.

Duplex Ringing (Requires Subscription to Service)

If you are a subscriber to Homefax 2 or 3, or Faxline 2 or 3, which are services provided by Pacific Century CyberWorks Ltd. (PCCW), you will need to turn on Duplex Ringing. When Duplex Ringing is turned on, the fax machine will signal voice calls by a short ringing cadence and faxes by a long ringing cadence.

- ◆ For more information on the Homefax service, please contact PCCW on 1000.
- ◆ **Duplex Ringing will only operate when the reception mode is set to FAX, TEL/FAX or A.M. mode.** When a fax comes in, the fax machine will automatically answer the call after the number of rings set with the NUMBER OF RINGS setting (see page 59). Voice calls must be answered by picking up the handset.

Important:



Duplex Ringing can only be used by Homefax 2, 3 and Faxline 2, 3 subscribers. Do not turn on Duplex Ringing if you are on a normal line, as the fax machine will not operate properly.

Follow these steps to turn on Duplex Ringing.

1 Press  **once** and  **once.**

Display:



OPTION SETTING 

2 Press  **once** and  **5 times.**

DUPLEX RINGING 

3 Press  **once.**

1=YES, 2=NO

4 Press  **to turn on the function, or**
 **to turn it off.**

The display briefly shows your selection, then:

FAX SIGNAL RX 

5 Press  **to return to the date and time display.**



Blocking Reception of Unwanted Faxes

The Anti Junk Fax function allows you to block reception of faxes from a party that you specify. This saves paper by not printing out unwanted "junk" faxes. To use this function, follow the steps below to enter the fax number from which you do not wish to receive faxes. One fax number can be entered.

1 Press **FUNCTION**  once and  twice.

Display:

ENTRY MODE 

2 Press  once and  twice.

ANTI JUNK # 

3 Press  once.

1=SET, 2=CLEAR

4 Press **1** to store an Anti Junk number, or **2** to clear a previously stored number (if you are clearing a number, go to Step 6).

5 Enter the fax number by pressing the number keys (max. 20 digits).



6 Press **START/MEMORY**  and then press **STOP**  to return to the date and time display.

Polling (Requesting a Fax Transmission)

Polling allows you to call another fax machine and have it send a document (previously loaded in its feeder) to your machine without assistance from the operator of the other machine.

- ◆ **Hint:** Polling is useful when you want the receiving fax machine, not the transmitting fax machine, to bear the cost of the call.

1 Dial the fax machine you want to poll using one of the following methods:

- Enter the full number using the numeric keys.
- Pick up the handset (or press ) and dial the full number. Wait for the fax answerback tone.
- If the number has been stored for automatic dialling, press  or  until the name (or number) of the other party appears in the display.

2 Press .

- If you used the handset, replace it when POLLING appears in the display. Reception will begin.

7. Printing Lists

You can print lists showing settings and information entered in the fax machine. The lists are described below. To print a list, follow these steps.

1 Press **FUNCTION**  once and  twice.

Display:

LISTING MODE 

2 Press  once.

TEL # LIST 

3 Press  or  until the desired list appears in the display.

4 Press  once.

PRESS START KEY

5 Press **START/MEMORY**  to print the list.

Telephone Number List

This list shows the fax and phone numbers that have been stored for automatic dialling.

Setup List

This list shows your current selections for the **FUNCTION** key settings. The list also shows your name and fax/telephone number as entered in the machine, and a sample of the header printed at the top of every page you transmit (**HEADER PRINT**).

SETUP LIST		12-NOV-2004 13:14
FOR:		
D.M. SETTING		
TOLL OWNER	YES	
RECORDING TIME	4 MIN.	
REMOTE CODE NO.	001	
OVERRIDE CODE NO.	000	
TRANSFER TELEPHONE NO.		
TRANSFER TELEPHONE CALLING	NO	
ON A.M. FAILURE	NO	
(LIMIT SETS TO AUTO FAX REV.)		
DDM ONLY MODE	NO	
ENTRY MODE		
ANTI JUNK NUMBER		
PRIORITY CALL NO.		
SENDER'S NAME		
SENDER'S TELEPHONE NUMBER		
HEADER PRINT		
12-NOV-2004 13:14		P.01
OPTION SETTING		
NUMBER OF RINGS IN AUTO ANSWER MODE	2 RINGS	
TEL/FAX REMOTE NO.	1511	
TRANSACTION PRINT SELECT	ERROR ONLY	
DIAL MODE	1ONE	
PSEUDO RINGING DURATION	15S	
DUPLEX RINGING	NO	
FAX SIGNAL RECEIVE	YES	
CALLER-ID	NO	
ECP MODE	YES	
RECEPTION RATIO	AUTO	
PRINT CONTRAST	NORMAL	
COPY CUT OFF	YES	

Message List

This list shows information about the messages currently recorded in the answering machine, including the date and time each messages was recorded, the length, and the type.

Caller-ID List

This list shows information about your 30 most recent calls. (This list is only available if you are using the Caller ID function.)

Transaction Report

This report is printed out automatically after an operation is completed to allow you to check the result. Your fax machine is set at the factory to print out the report only when an error occurs.

- ◆ The Transaction report cannot be printed on demand.

Headings in Transaction Report

**SENDER/
RECEIVER** The name or fax number of the other machine involved in the transaction. If that machine does not have an ID function, the communication mode will appear (for example, "G3").

START The time at which transmission/reception started.

TX/RX TIME Total time taken for transmission/reception.

PAGES Number of pages transmitted/received.

NOTE (One of the following notes will appear under **NOTE** in the report to indicate whether the transaction was successful, and if not, the reason for the failure.)

OK - Transmission/reception was successful.

P.FAIL - A power failure prevented the transaction.

JAM - The printing paper or document jammed, preventing the transaction.

BUSY - The fax was not sent because the line was busy.

COM.E-X - (Where "X" is a number.) A telephone line error prevented the transaction. See *Line error* on page 83.

CANCEL - The transaction was cancelled because the **STOP** key was pressed, no document was in the feeder, or the other machine requested transmission using a function which your fax machine does not have. If you were attempting to fax, make sure a document is in the feeder. If you were receiving, contact the faxing party to see how they are trying to send to you.



Transaction Report print condition

You can change the condition under which a Transaction Report is printed out. Follow the steps below.

1 Press  once and  once.

Display:

OPTION SETTING 

2 Press  once and  twice.





TRANSACTION 

3 Press  once.

1:ALWAYS PRINT

(Selections appear alternately)

4 Press a number from  to  to select the condition for printing.

- | | |
|---|--|
|  ALWAYS PRINT | A report will be printed after each transmission, reception, or error. |
|  ERROR/MEMORY | A report will be printed after an error or a memory operation. |
|  SEND ONLY | A report will be printed after each transmission. |
|  ERROR ONLY | A report will be printed only when an error occurs. |
|  NEVER PRINT | A report will never be printed. |

The display briefly shows your selection, then:

DIAL MODE 

5 Press  to return to the date and time display.

8. Maintenance

Print head

Clean the print head frequently to ensure optimum printing performance.

Note: Remove the paper from the paper tray before cleaning the print head.

- 1** Unplug the telephone line and then the power cord, and open the operation panel (press **1**).

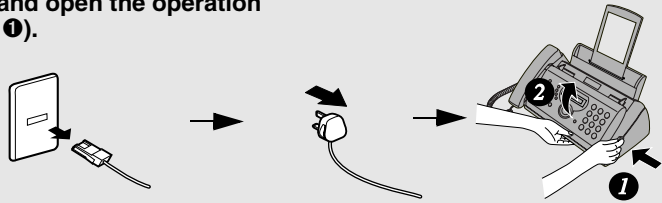

- 2** Take the imaging film out of the print compartment and place it on a sheet of paper.

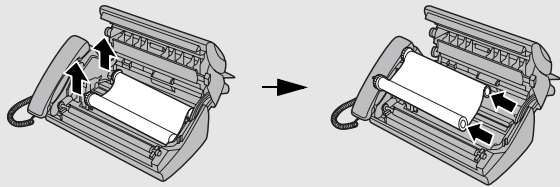

- 3** Wipe the print head with isopropyl alcohol or denatured alcohol.

Caution!

- Do not use benzene or thinner. Avoid touching the print head with hard objects.
- The print head may be hot if your fax machine has just received a large number of documents. If this is the case, allow the print head to cool prior to cleaning.

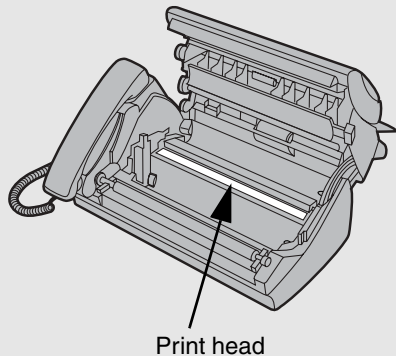

- 4** Place the imaging film back in the print compartment.

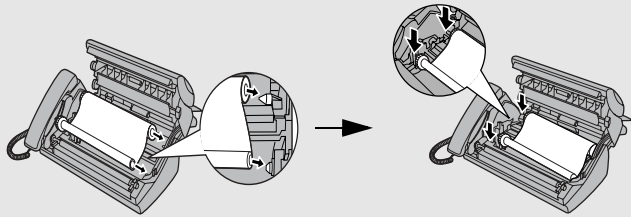

- 5** Rotate the front gear until the film is taut, and then close the operation panel (press down on both sides to make sure it clicks into place).

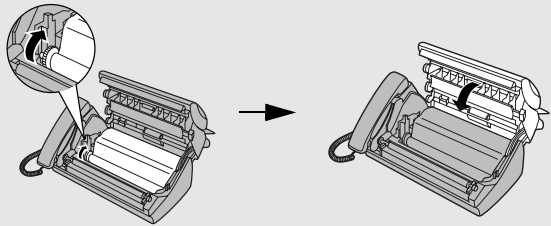

Scanning glass and rollers

Clean the scanning glass and rollers frequently to ensure the quality of transmitted images and copies.

Note: Remove the paper from the paper tray before cleaning the scanning glass and rollers.

- 1** Open the operation panel (press **1**).



- 2** Flip up the green levers on each side of the white roller.

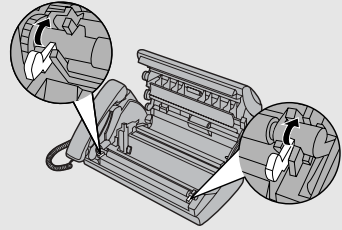

- 3** Wipe the scanning glass (under the white roller) and rollers with a cotton swab.

- Make sure that all dirt and stains (such as correcting fluid) are removed. Dirt and stains will cause vertical lines on transmitted images and copies.

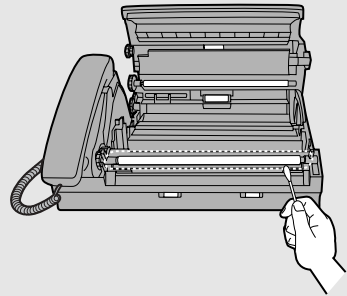

If the scanning glass is difficult to clean

If you find it difficult to remove dirt from the scanning glass, you can try moistening the swab with isopropyl alcohol or denatured alcohol. Take care that no alcohol gets on the rollers.

- 4** Flip down the green levers on each side of the white roller. Rotate the front gear until the film is taut, and then close the operation panel (press down on both sides to make sure it clicks into place).

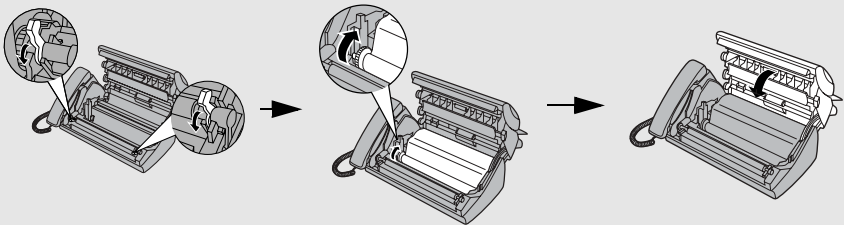

The housing

Wipe the external parts and surface of the machine with a dry cloth.

Caution!

Do not use benzene or thinner. These solvents may damage or discolor the machine.

9. Troubleshooting

Problems and Solutions

Line error

Problem	Solution
LINE ERROR appears in the display.	<p data-bbox="421 443 978 496">Try the transaction again. If the error persists, check the following:</p> <ul data-bbox="421 528 986 1007" style="list-style-type: none"><li data-bbox="421 528 986 608">• Check the connection. The cord from the TEL. LINE socket to the wall socket should be no longer than two meters.<li data-bbox="421 639 986 692">• Make sure there are no modem devices sharing the same telephone line.<li data-bbox="421 724 986 777">• Check with the other party to make sure their fax machine is functioning properly.<li data-bbox="421 809 986 836">• Have your telephone line checked for line noise.<li data-bbox="421 868 986 920">• Try connecting the fax machine to a different telephone line.<li data-bbox="421 952 986 1007">• If the problem still occurs, your fax machine may need service.

Dialling and transmission problems

Problem	Solution
<p>No dial tone when you pick up the handset or press the  key.</p>	<ul style="list-style-type: none"> • Make sure the handset cord is connected to the correct socket. See <i>Connecting the handset</i> on page 10.
<p>Dialling is not possible.</p>	<ul style="list-style-type: none"> • Make sure the power cord is properly plugged into a power outlet. • Make sure that the telephone line is properly connected to both the TEL. LINE socket and the wall socket. • Make sure that the fax machine is set to the correct dialling mode for your telephone line. See <i>Dial mode</i> on page 11.
<p>The power is on, but no transmission takes place.</p>	<ul style="list-style-type: none"> • Make sure that the receiving machine has paper. • Make sure that the telephone line cord is plugged into the TEL. LINE socket, and not the TEL. SET socket. • If the receiving machine is in manual mode with no attendant, reception will not be possible. • Check the display for error messages. • Pick up the handset and check for a dial tone.
<p>Nothing is printed at the receiving end.</p>	<ul style="list-style-type: none"> • Make sure that the document for transmission is placed face down in the feeder.
<p>A distorted image is received at the other end.</p>	<ul style="list-style-type: none"> • Noise on the telephone line may cause distortion. Try sending the document again. • Make a copy of the document on your fax machine. If the copy is also distorted, your fax machine may need service.

Reception and copying problems

Problem	Solution
The power is on, but no reception takes place.	<ul style="list-style-type: none"> • Make sure that the telephone line cord is plugged into the TEL. LINE socket, and not the TEL. SET socket.
The printing paper comes out blank when you try to receive a document.	<ul style="list-style-type: none"> • Make sure that the document is loaded properly in the feeder of the transmitting machine. Make a copy or print a report to confirm the printing ability of your machine.
General print quality is poor.	<ul style="list-style-type: none"> • It is important to select a paper that is appropriate for the thermal transfer printer in your fax. We recommend using laser quality paper that has a very smooth finish. Copier paper will work, but it sometimes tends to yield a lighter print quality.
The received document is faint.	<ul style="list-style-type: none"> • Ask the other party to send higher contrast documents. If the contrast is still too low, your fax machine may need service. Make a copy or print a report to check your machine's printing ability.
Received images are distorted.	<ul style="list-style-type: none"> • Noise on the telephone line may cause distortion. Have the other party try sending the document again. • The print head may be dirty. See <i>Print head</i> on page 80. • Make a copy or print a report on your fax machine. If the copy or report is also distorted, your fax machine may need service.
A received document or copy prints out in strips.	<ul style="list-style-type: none"> • Make sure the operation panel is completely closed (press down on both sides of the panel).
The quality of copies is poor and/or dark vertical lines appear.	<ul style="list-style-type: none"> • Any dirt or material on the scanning glass will cause spots to appear on copies and transmitted faxes. Clean the scanning glass as explained on page 81.

Reception/copying is interrupted.	<ul style="list-style-type: none"> • If reception or copying takes place continuously for a long time, the print head may overheat. Turn off the power and let it cool down. If overheating frequently occurs, try changing the print contrast setting to LIGHT (see page 17).
Dark vertical lines appear on copies and received faxes.	<ul style="list-style-type: none"> • Try changing the print contrast setting to LIGHT (see page 17).

General problems

Problem	Solution
A loud howling sound occurs when the speaker is used.	<ul style="list-style-type: none"> • Feedback (a loud howling sound) may occur if you replace the handset while the speaker is on. To avoid feedback, turn off the speaker (press ) before you replace the handset.
Auto-dial numbers cannot be stored in the fax.	<ul style="list-style-type: none"> • Make sure the fax is plugged in and the imaging film has been loaded. (Auto-dial numbers cannot be stored if the imaging film has not been loaded.) See <i>Loading the Imaging Film</i> on page 14.
Nothing appears in the display.	<ul style="list-style-type: none"> • Make sure the power cord is properly plugged into a power outlet. • Connect another electrical appliance to the outlet to see if it has power.
The machine does not respond when you press any of its keys.	<ul style="list-style-type: none"> • If a beep sound is not made when you press the keys, unplug the power cord and then plug it in again several seconds later.
Automatic document feeding does not work for transmission or copying.	<ul style="list-style-type: none"> • Check the size and weight of the document (see <i>Transmittable Documents</i> on page 43).

Messages and Signals

Display messages

Note: If you have turned on the Caller ID function, see page 69 for display messages related to Caller ID.

ADD PAPER & / PRESS START KEY (alternating messages)	Check the printing paper. If the tray is empty, add paper and then press the START/MEMORY key. If there is paper in the tray, make sure it is inserted correctly (take out the stack, align the edges evenly, and then reinsert it in the tray) and then press the START/MEMORY key.
A.M. TRANSFER	The answering machine's transfer function has been turned on (see page 32).
CHECK FILM/ CHECK COVER/ CHECK PAPER JAM (alternating messages)	These alternating messages appear when there is a problem in the print compartment that prevents printing. Check to see if the imaging film is not loaded properly or if it has been used up and needs replacement. Make sure the operation panel is completely closed (press down on both sides). If a paper jam has occurred, clear the jam as explained in the following section, <i>Clearing Paper Jams</i> .
CHECK PAPER SIZE	An incorrect size of paper has been loaded in the paper tray. Remove the paper and load A4-size paper.
DOCUMENT JAMMED	The original document is jammed. See the following section, <i>Clearing Paper Jams</i> . Document jams will occur if you load more than 10 pages at once or load documents that are too thick (see page 43).
FAX RX IN MEMORY	A fax has been received in memory because the imaging film needs replacement, you have run out of printing paper, or the paper is jammed. The fax will print out automatically when the problem is fixed.
FUNCTION MODE	The FUNCTION key has been pressed.

Messages and Signals

LINE ERROR	Transmission or reception was not successful. Press the STOP key to clear the message and then try again. If the error persists, see <i>Line Error</i> on page 83.
MEMORY IS FULL/ SEE MANUAL (alternating messages)	The memory is full. You may have too many messages recorded in the answering machine. To erase messages, see page 29. This message may also occur during fax reception if too much data is received before the pages can be printed out. If faxes have been received to memory because printing is not possible (an additional message will indicate the problem), resolve the problem so that printing can continue (see <i>Substitute Reception to Memory</i> on page 65). If you are attempting to transmit from memory, see <i>If the memory becomes full</i> on page 56. If you are copying, see <i>If MEMORY IS FULL appears</i> on page 66.
MEMORY PRINTING	The fax is preparing to or printing out a document from memory.
NO DATA	This appears if you attempt to search for an auto-dial number when none have been stored.
OFF HOOK	This appears if you forgot to replace the handset after using it to dial and send a fax. Replace the handset or press the STOP key to clear the message.
ON HOOK DIAL	The  key has been pressed and the fax machine is waiting for you to dial.
OVER HEAT	The print head has overheated. Operation can be continued after it cools. If overheating frequently occurs, try changing the print contrast setting to LIGHT (see page 17).
PRINT HEAD FAIL/ YOU NEED SERVICE (alternating messages)	The print head has failed and requires service.
READY TO SEND	A document has been loaded and the fax machine is waiting for you to begin faxing or copying.

RECALLING	This appears if you attempt to send a fax by automatic dialling and the line is busy or the receiving fax machine does not answer. Your fax machine will automatically reattempt the call. (See <i>Automatic redialling</i> on page 53.)
TOTAL MSGS:XX	This indicates that you have received messages in the answering machine. "XX" is the number of messages.
TOTAL PAGE(S) 01	Number of pages transmitted, received, or copied.

Audible signals

Continuous tone	3 seconds	Indicates the end of transmission, reception, or copying.
Intermittent tone (3 beeps)	5 seconds (1 second on, 1 second off)	Indicates incomplete transmission, reception, or copying.
Rapid intermittent tone	35 seconds (0.7 seconds on, 0.3 seconds off)	Indicates that the handset is off hook.

Clearing Paper Jams

Clearing a jammed document

If the original document doesn't feed properly during transmission or copying, or DOCUMENT JAMMED appears in the display, first try pressing

START/MEMORY



. If the document doesn't feed out, remove it as explained below.

Important:

Do not try to remove a jammed document without releasing it as explained below. This may damage the feeder mechanism.

- 1** Press **1** and slowly open the operation panel until it is half open.

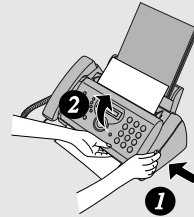

- 2** Flip up the green levers on each side of the white roller.

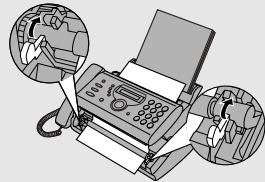

- 3** Gently remove the document.

- Be careful not to tear the document.

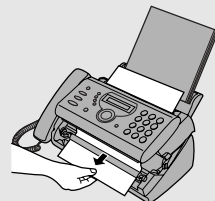

- 4** Flip down the green levers on each side of the white roller. Rotate the front gear until the film is taut, and then close the operation panel (press down on both sides to make sure it clicks into place).

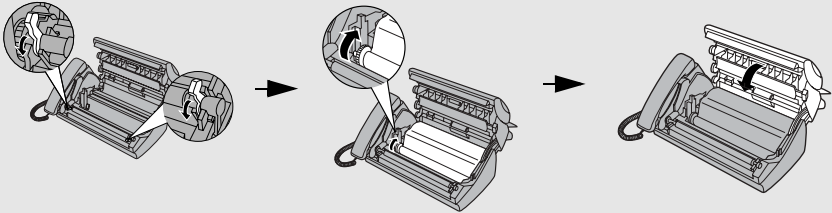

Clearing jammed printing paper

- 1** Open the operation panel (press ❶).

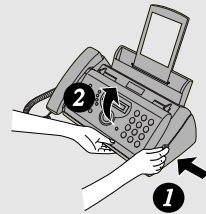

- 2** Gently pull the jammed paper out of the machine, making sure no torn pieces of paper remain in the print compartment or rollers.

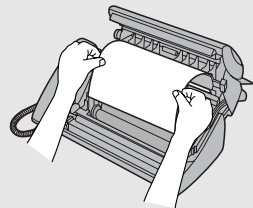

- 3** Rotate the front gear until the film is taut, and then close the operation panel (press down on both sides to make sure it clicks into place).

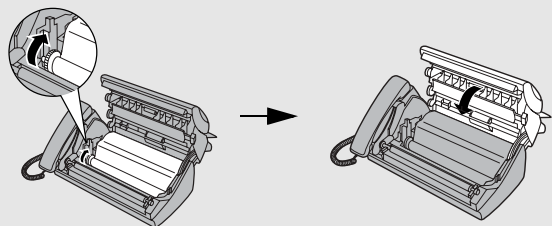

Index

A

- A.M. reception mode, 22, 26, 58
- Anti Junk Fax, 74
- Audible signals, 89
- Auto-dial numbers
 - Storing, 48
 - Using, 51

C

- Caller ID, 68-72
- Caller ID List, 77
- Contrast, 46
- Copies, 66
- Copy cut-off setting, 67

D

- Date, setting, 20
- Dial mode, 11
- Dialling
 - Automatic, 51
 - Direct Keypad, 52
 - Normal, 47
- Direct Keypad Dialling, 52
- Display messages, 87
- Document feeder, 44
- Document guides, 44
- Document restrictions, 44
- Document sizes, 43
- Document, maximum scanning size, 43
- Duplex Ringing, 73

E

- ECM (Error Correction Mode), 54
- Extension telephone
 - Connecting, 13
 - Using, 61

F

- FAX reception mode, 22, 59
- Fax reception on A.M. failure, 30
- Fax Signal Receive, 62

H

- Halftone setting, 45
- Handset, 10
- Hold, 62
- Housing, cleaning, 82

I

- Imaging film, replacing, 14

J

- Jams, clearing, 90-91

L

- Letters, entering, 19, 49
- Line error, 83
- Loading paper, 16
- Loading the document, 44

M

- Memory transmission, 56
- Memory, substitute reception to, 65
- Message List, 77
- Messages
 - Erasing, 29
 - Listening to, 28
 - Listening to remotely, 38
 - Setting allowed time, 30

N

- Normal Dialling, 47
- Number of rings in A.M. mode, 27
- Number of rings in FAX reception mode, 59

Index

O

OGM only mode, 31
Outgoing message, 25
Override Ringing, 35

P

Paper jams, clearing, 90-91
Paper tray extension, 12
Paper, loading, 16
Polling, 75
Power cord, 10
Print contrast setting, 17
Print head, cleaning, 80-81
Priority Call, 71
Pseudo Ring Duration, 57

R

Reception mode
 A.M. mode, 22, 26, 58
 FAX mode, 22, 59
 TEL mode, 22, 60
 TEL/FAX mode, 22, 57
Reception Ratio setting, 64
Redialling, 53
Remote code number, 37
Remote operations, 37
Resolution, 45
Ringer volume, 24

S

Scanning glass, cleaning, 81
Sender's name and number, entering,
 18-19
Setup List, 77
Speaker volume, 23

T

TEL reception mode, 22, 60
TEL. LINE socket, 11
TEL. SET socket, 13
TEL/FAX reception mode, 22, 57
Tel/Fax Remote Number, 63
Telephone line cord, 11
Telephone Number List, 77
Time, setting, 20
Toll Saver function, 27, 37
Transaction Report, 78
 Setting print condition, 79
Transfer Function, 32

REMOTE OPERATION CARD

The card below is provided as a quick guide to remote operation. Cut it out and carry it with you when you go out.

<p>Remote Operation Guide</p> <p>SHARP®</p> <ol style="list-style-type: none">1. Call your fax from a touch-tone telephone, and press <input type="checkbox"/># when the outgoing message begins.2. Enter your remote code: <input type="checkbox"/><input type="checkbox"/><input type="checkbox"/> .3. Press <input type="checkbox"/># .4. After listening to your messages, you can either hang up to save them, or enter one of the commands on the reverse side.
--

REMOTE COMMANDS

- **PLAYBACK**

Play messages **7** **#**
 Move backward/repeat..... **2** **#**
 Skip forward..... **5** **#**
 Stop **0** **#**
 Play new messages only .. **6** **#**
 (first stop playback)

- **ERASING MESSAGES**

Erase single message **3** **#**
 Erase all messages **3** **3** **#**

- **RECORDING A MEMO**

Start ***#** **#**
 End **0** **#**

- **RECORDING A NEW OGM**

Start **4** *****

- **FAX RECEPTION MODES**

A.M. mode **8** **1** **#**
 FAX mode **8** **2** **#**
 TEL mode **8** **3** **#**
 TEL/FAX mode **8** **4** **#**

- **TRANSFER FUNCTION**

Turn on **9** **1** **#**
 Turn off **9** **2** **#**
 New transfer number **9** **0** **#**
 →(Tel. No.) **#**
 Record transfer OGM **9** **3** **#**
 To quickly disconnect..... ***** *****

- **OGM ONLY MODE**

Turn on **1** **1** **#**
 Turn off **1** **2** **#**

簡介

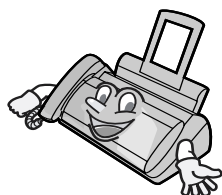

感謝您選購 Sharp 傳真機！
以下所示為您的新型 Sharp
傳真機的功能與規格。

自動撥號	40 個號碼
膠卷	首次使用的膠卷 (傳真機隨附) : 50 米 (約 150 張 A4 尺寸頁面) 更換用膠卷 (未附送) : FO-9CR 60 米 (一個膠卷 約 180 張 A4 尺寸頁面)
記憶體大小*	448 KB (不錄製留言時平均約為 24 頁；記憶體內未儲存文件時可錄製 20 分鐘留言 [包括外出留言信息])
解調器速度	14,400 bps，自動調降速度。
傳送時間*	約 6 秒鐘 (僅限 ECM 開啟時)
解像度	水平 : 8 像素/毫米 垂直 : 標準 : 3.85 線/毫米 細緻/半色調 : 7.7 線/毫米 超細緻 : 15.4 線/毫米
自動文件送紙器	最多 10 頁 (A4，80 g/m ² 紙張)
記錄系統	感熱式
半色調 (灰度)	64 級
壓縮模式	MR、MH、MMR
供紙托架容量 (60 - 80 g/m² 紙張)	約 50 張 A4 尺寸紙張 (正常室溫下；紙張堆疊高度不可超過供紙托架標示的界線)

*在 Sharp 特殊模式下以標準解像度，基於 Sharp 標準圖表，不包括通訊規程信號，(如，僅 ITU-T 相位 C 時間) 所需的時間。

顯示屏	16 位 LCD 顯示屏
適用電話線路	公用交換電話網絡
相容性	ITU-T (CCITT) G3 模式
輸入文件尺寸	自動送紙： 闊度：148 至 216 毫米 長度：140 至 297 毫米 手動送紙： 闊度：148 至 216 毫米 長度：140 至 600 毫米
有效掃描闊度	最闊 210 毫米
有效打印闊度	最闊 204 毫米
對比度控制	自動/深色可調式
接收模式	TEL/FAX (電話/傳真)、TEL (電話)、 FAX (傳真)、A.M. (留言機)
複印功能	單張/多張 (99 份/頁)
電話功能	有 (如發生電源故障則無法使用)
電源要求	220-240 V，50/60 Hz 交流電
操作溫度	5 - 35°C
濕度	相對濕度 25% 至 85%
耗電量	待機：2.5 W 最大：110 W
尺寸 (不含附件)	闊：327 毫米 深：193 毫米 高：163 毫米
重量 (不含附件)	約 2.8 千克

秉持著不斷改善的原則，Sharp 保留對產品改良設計與規格變更的權利，恕不另行通知。
上述性能規格數據為產品的標稱值。個別產品的數據可能會有所不同。

重要安全須知

請勿拆裝本傳真機或嘗試執行本操作手冊內未述及的步驟。傳真機的所有維修工作，請交由合格的維修人員處理。

請勿在鄰近水源或身體潮濕時安裝或使用傳真機。例如，不要在浴缸、洗臉盆、廚房水槽、洗衣盆、潮濕的地下室或游泳池附近使用傳真機。請勿讓任何液體濺到傳真機。

如果發生以下任何一種情況，請先把電話插座上的電話線插頭拔下，然後再拔下電源插座上的電源插頭，並洽詢合格的維修人員：

- 液體濺入傳真機或傳真機曾暴露在雨水或一般用水中。
- 傳真機發出異味、冒煙或發出不正常的噪音。
- 電源線磨損或毀壞。
- 傳真機摔落或機殼損毀。

切勿將任何物品放置在電源線上，亦不要將傳真機安裝在電源線會被踐踏的地方。

本傳真機只能連接到 220-240 V，50/60 Hz 的接地型 (3 腳) 電源插座上。將傳真機連接到任何其他類型的電源插座均會使機器受損。

切勿將任何物品插入傳真機上的插槽或開口處，這可能導致火災或觸電。如果有物品掉入傳真機內而您無法將其取出，請立即拔掉傳真機的電源插頭，並洽詢合格的維修人員。

切勿將傳真機放置在不平穩的手推車、支架或桌子上。如果讓傳真機摔落，可能會造成嚴重損毀。

切勿在雷雨天氣中安裝電話線。

切勿在潮濕的地方安裝電話插座，除非是專門為潮濕場所設計的插座。

切勿觸摸裸露的電話線或接線端子，除非已切斷電話線路與網絡介面的連接。

在安裝或修改電話線路時請小心。

避免在雷雨天氣中使用電話 (無線電話除外)。否則，可能會因閃電而導致觸電的危險。

切勿在瓦斯洩漏的現場附近使用電話報告洩漏事故。

請務必將電源插座安裝在靠近設備且易於插接或拔除的地方。

目錄

操作面板概覽	6
1. 安裝	9
拆箱	9
連接	10
裝入膠卷	14
放入打印紙	16
輸入姓名和傳真號碼	18
設定日期和時間	20
設定接收模式	22
調整音量	23
2. 使用留言機	25
錄製外出留言信息	25
操作留言機	26
可選用的留言機設定	30
轉接功能	32
略過響鈴	35
遙距操作	37
3. 傳送傳真	43
可傳送的文件	43
放入文件	44
調整解像度與對比度	45
透過一般撥號傳送傳真	47
透過自動撥號傳送傳真	48
透過記憶體傳送傳真	55
4. 接收傳真	57
使用電話/傳真模式	57
使用留言機模式	58
使用傳真模式	59
使用電話模式	60
可選用的接收設定	62
替代接收至記憶體	65

5. 複印	66
6. 特殊功能	68
來電顯示 (需要另行申請的服務)	68
雙音辨號 (需要另行申請的服務)	73
停止接收不要的傳真	74
自動回傳 (請求傳送傳真)	75
7. 打印清單	76
8. 維護	80
9. 故障排除	83
問題與解決方法	83
信息與信號	87
清除夾紙	90
快速參考指南	92
索引	93

操作面板概覽

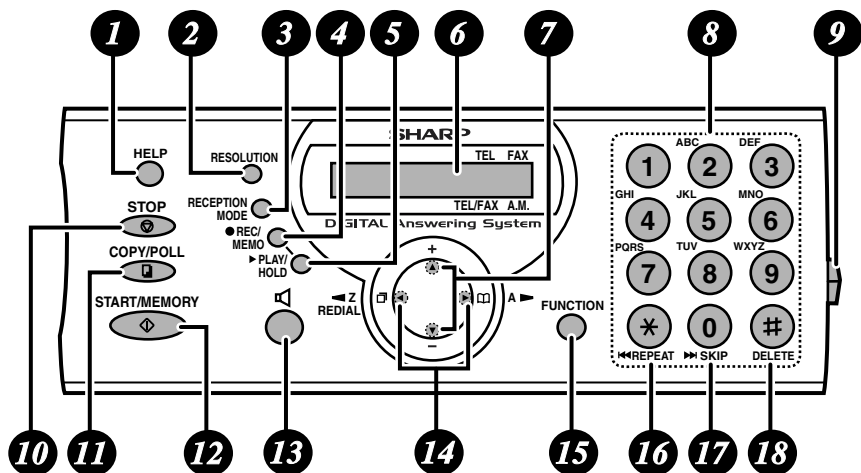

- 1 HELP (說明)**
按下此鍵可打印「說明表」，即操作傳真機的快速參考指南。
- 2 RESOLUTION (解像度) 鍵**
按此鍵可調整傳真或複印的解像度 (第 45 頁)。
- 3 RECEPTION MODE (接收模式) 鍵**
按此鍵可選擇接收模式 (顯示屏上的箭頭將會指向目前選定的接收模式；第 22 頁)。
- 4 REC/MEMO (錄音/備忘) 鍵**
按下此鍵可錄製外出留言信息、通話內容或備忘 (第 25 與 29 頁)。
- 5 PLAY/HOLD (播放/保留) 鍵**
按此鍵可播放錄音信息 (第 28 頁)，或保留通話 (第 62 頁)。
- 6 顯示屏**
顯示可協助您操作本傳真機的信息和提示。

- 7 上與下方向鍵**
放大/縮小設定：複印文件時，按這些按鍵可選擇放大/縮小的設定值 (第 66 頁)。
音量設定：在送紙器沒有放入文件且已按下  鍵時，按這些鍵可變更喇叭音量；在任何其他情況下，按這些鍵可變更響鈴音量 (第 23 頁)。
功能鍵設定：按下**功能**鍵後，按這些按鍵可捲動瀏覽整個「功能模式」的設定項目。
- 8 數字鍵**
這些按鍵可用來撥號，並可在儲存自動撥號號碼時輸入數字和字母。
- 9 面板釋放鈕**
按此鈕可開啟操作面板。
- 10 STOP (停止) 鍵**
按下此鍵可取消尚未完成的作業。
- 11 COPY/POLL (複印/自動回傳) 鍵**
按下此鍵可複印文件 (第 66 頁)。撥號至另一台自動回傳傳真機 (要求對方傳送傳真) 後也需要使用此鍵 (第 75 頁)。
- 12 START/MEMORY (開始/記憶) 鍵**
撥號後按此鍵開始傳送傳真 (第 47 頁)。撥號前按此鍵以透過記憶體傳送傳真 (第 55 頁)。
- 13 免提聽筒鍵**
按此鍵可在傳送文件時透過喇叭來監聽線路與傳真信號 (第 47 頁)。
- 14 左與右方向鍵**
自動撥號號碼：在傳送傳真或撥打電話時，按這些按鍵可以捲動尋找自動撥號號碼 (第 53 頁)、<REVIEW CALLS (來電檢視)> 清單 (僅適用於來電顯示功能，第 69 頁)，以及最後一次撥打的號碼 (重撥；第 53 頁) 中捲動。
功能鍵設定：使用上下方向鍵瀏覽後，按右方向鍵可選擇**功能**鍵的設定項目。
- 15 FUNCTION (功能) 鍵**
按此鍵後再按方向鍵，可選用特殊功能與設定。

16 REPEAT (重複) 鍵
聽取信息時按下此鍵可再次播放信息 (第 28 頁)。

17 SKIP (略過) 鍵
聽取信息時按下此鍵可跳至下一則信息 (第 28 頁)。

18 DELETE (刪除) 鍵
按下此鍵可清除錄音信息 (第 29 頁)。

監聽對話內容

使用聽筒通話時，可按  讓其他人透過喇叭聽到通話內容。(要關閉免提聽筒功能，再按此鍵一次。)

要調整監聽對話時的喇叭音量，請按  或按  提高或降低音量 (聽筒掛上時，音量設定會回復至低音量設定)。

請注意，**免提聽筒功能無法用來講電話**；只適用於監聽。

要避免回音 (刺耳的噪音)，請在掛回聽筒前，確定已關閉免提聽筒 (再按  一次) 功能。

1. 安裝

拆箱

請在安裝前，確定以下所有物品均已齊全。



如有任何遺漏，請聯絡經銷商或零售商。



供紙托架

供紙托架延伸板

操作手冊

齒輪 (2)

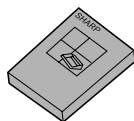
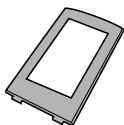
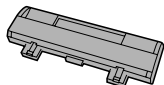

聽筒

聽筒連接線

電話線

膠卷 (首次使用的膠卷)

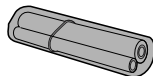
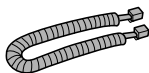

安裝注意事項

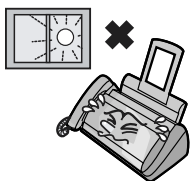

請勿將傳真機放置在陽光直接照射的地方。

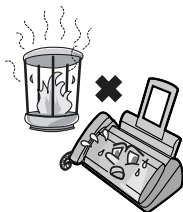

請勿將傳真機放置在靠近暖氣裝置或空調設備的地方。

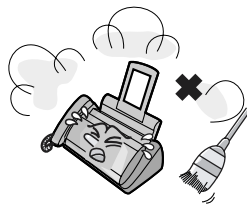

請勿讓傳真機沾滿灰塵。

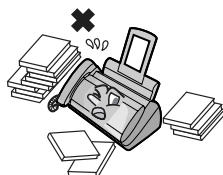

請保持傳真機周圍清潔。

關於冷凝

將傳真機從較寒冷的地方移至較溫暖的地方時，傳真機的掃描鏡上可能有冷凝現象，這會影響傳送文件時的正常掃描。要消除冷凝現象，請開啟電源，並等候大約兩個小時後再使用傳真機。

連接

連接聽筒

如圖所示連接聽筒，並將其置於聽筒架上。

- ◆ 聽筒連接線的兩端均相同，因此它們可插入任何一個插孔內。

請確定已將聽筒連接線插入傳真機側面標有聽筒符號的插孔！

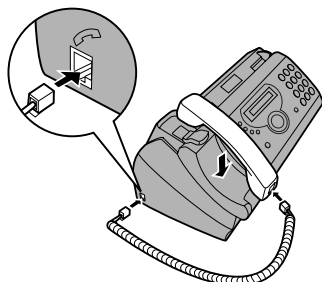

您可以使用聽筒來撥打一般電話，或手動傳送與接收傳真。

連接電源線

將電源線插入 220-240 V，50/60 Hz 的接地型 (3 腳) 交流電源插座。

- ◆ 在中斷傳真機的連接時，請先拔掉電話線，然後再拔除電源線。
- ◆ 注意：請務必將電源插座安裝在靠近設備且易於插接或拔除的地方。

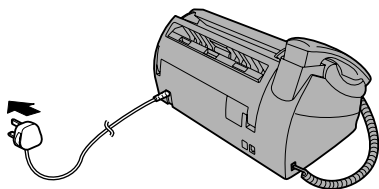

傳真機沒有電源開關，因此僅需插入或拔下電源線即可開啟與關閉電源。



連接電話線

將電話線的一端插入傳真機背面標有 **TEL. LINE. (電話線)** 的插孔，然後將另一端插入牆壁上的電話插座。

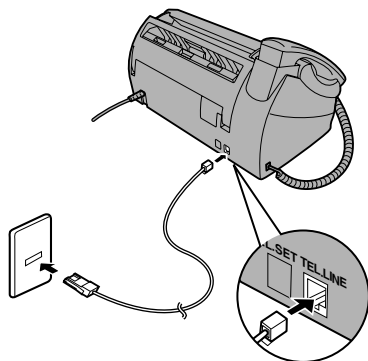

設定撥號模式：

本傳真機預設為音頻撥號。如使用的是脈衝式撥號線路，您必須將傳真機設定為脈衝式撥號。請按下操作面板上的按鍵 (如下所示)：

1 依次序按 **FUNCTION** 與 **▲** 一下。

顯示屏顯示：

OPTION SETTING **↔**
(選項設定)

2 按 **▶** 一下，再按 **▼** 三下。

DIAL MODE **↕**
(撥號模式)

3 按 **▶** 一下。

1=TONE, 2=PULSE
(1=音頻, 2=脈衝)

4 選擇撥號模式：

TONE: (音頻) **①**

PULSE: (脈衝) **②**

顯示屏上將會簡略地顯示您的選擇，然後顯示：

PSEUDO RING **↔**
(虛擬響鈴)

5 按 **STOP** 退出。

連接

註解：

- ◆ 本傳真機不能在具有來電等候、來電轉接或其他電訊公司提供之特殊服務的線路上使用。如果您嘗試將傳真機與以上任何一項服務一起使用，則可能會在收發傳真時遇到問題。
- ◆ 本傳真機與數碼電話系統不相容。
- ◆ 如果您所在的地區經常發生閃電或電湧情況，我們建議您為電源與電話線路安裝電湧保護器。您可在經銷商或大多數電話專門店裏購買到電湧保護器。

移動傳真機與重新連接

如果要將傳真機移至新的地點，請務必先拔掉電話線，然後再拔除電源線。在重新連接時，請務必先連接電源線，然後再連接電話線。

安裝供紙托架與托架延伸板

安裝供紙托架

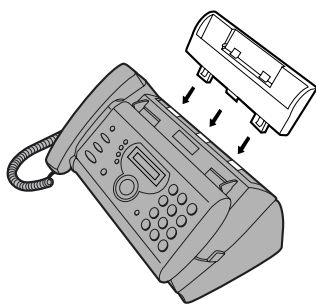

安裝供紙托架延伸板

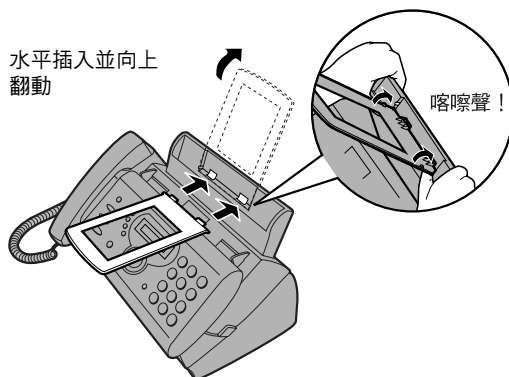

註：供紙托架延伸板分為正反兩面。如果您無法將凸片插入小孔，請翻轉支撐架。

電話分機 (選購)

如有需要，可將分機連接至傳真機上的 **TEL. SET (電話機)** 插孔。

- 1 取下覆蓋 TEL. SET (電話機) 插孔的封條。

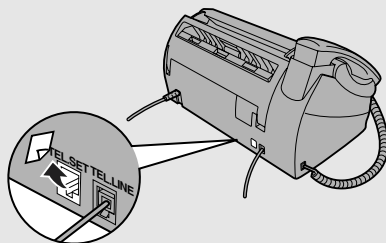

- 2 將分機電話線連接至 TEL. SET (電話機) 插孔。

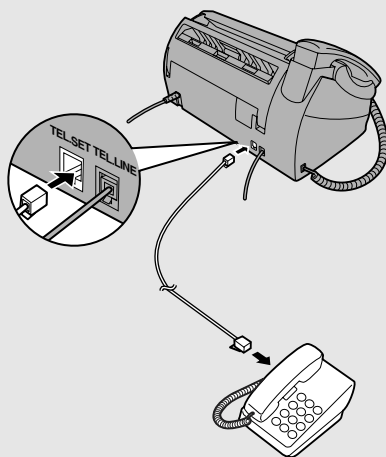

裝入膠卷

此傳真機使用膠卷產生打印的文字和影像。傳真機內的印字頭會將膠卷加熱，將墨水轉印到紙張上。請執行以下步驟來裝入或更換膠卷。

傳真機隨附的首次使用膠卷可打印約 150 頁 A4 尺寸的紙張。



更換膠卷時，請使用 Sharp FO-9CR 膠卷。一個膠卷可以打印約 180 張 A4 尺寸的紙張。

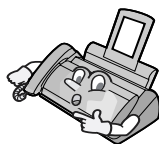

- 1 從供紙托架中取出紙張，然後打開操作面板 (按 ❶)。

如果您是第一次裝入膠卷，請跳至步驟 4。

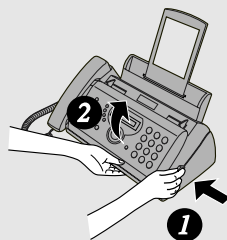

- 2 取出用過的膠卷與空捲軸。

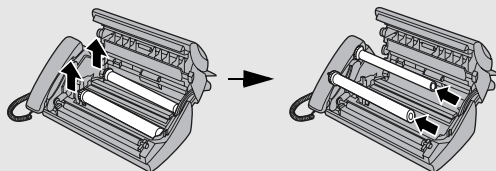

- 3 取下捲軸上的兩個綠色齒輪。切勿丟棄這兩個綠色齒輪！

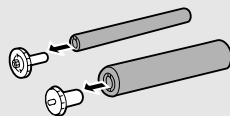

4 從包裝中取出新的膠卷。

- 剪斷將卷筒綁在一起的帶子。

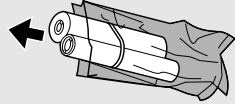

5 插入綠色齒輪。

確定齒輪已卡入卷筒末端的插槽中。

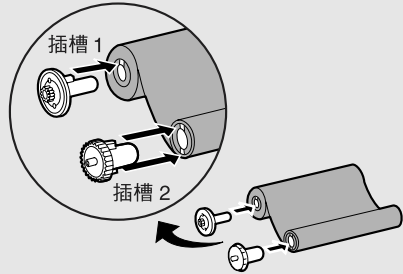

6 將膠卷插入打印槽內。

將卷筒末端卡在輪軸上

厚卷筒
在後面

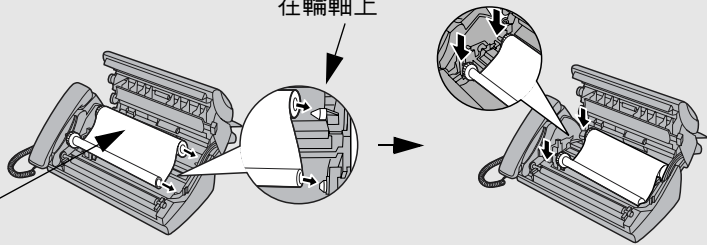

7 如圖所示轉動前端齒輪直到膠卷拉緊。

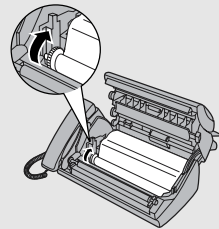

8 關上操作面板 (按下兩側，確定其已卡入定位)。

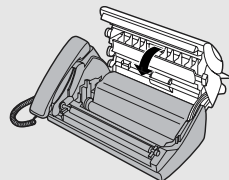

放入打印紙

托架內最多可放入 50 張 A4 尺寸、60 - 80 g/m² 紙張 (正常室溫下；紙張堆疊高度不可超過托架標示的界線)。

- 1** 來回翻動紙張，然後在平面上輕拍紙疊的邊緣以使其整齊。確保紙疊的邊緣整齊。

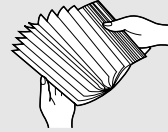

- 2** 將紙疊插入托架中，打印面朝下。

- 如果托架中尚有紙張，請將其取出並與新的紙張一起整理成一疊。
- 請務必正確放入紙張，以便能在紙張的**打印**面上進行打印。在反面上進行打印可能會導致打印品質不良。
- **請將紙張輕輕放入供紙托架。**
- **切勿強行將紙張插入送紙槽。**

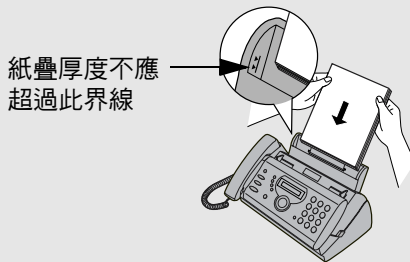

註：請勿使用已經打印過的紙張，或捲曲的紙張。

註：任何時候如果顯示屏右側出現交替信息，請檢查打印紙。若供紙托架的紙張已用完，請補充紙張。若托架內中仍有紙張，請將其取出再重新裝入。完成後，按

START/MEMORY 

ADD PAPER &

(添加  紙張並 )

PRESS START KEY

(按下開始鍵)



設定打印對比度

本傳真機的對比度在出廠時已設為以正常對比度打印。如有需要，您可將打印對比度設定值變更為 LIGHT (淡)。

1 依次序按  與  一下。

顯示屏顯示：

OPTION SETTING 
(選項設定)

2 按  一下，再按  兩下。

PRINT CONTRAST 
(打印對比度)

3 按  一下。

1:NORMAL
(1：正常)

4 選擇打印對比度：

NORMAL: (正常:) 

LIGHT: (淡:) 

顯示屏上將會簡略地顯示您的選擇，然後顯示：

COPY CUT-OFF 
(複印中斷)

5 按  返回日期和時間顯示。

輸入姓名和傳真號碼

在開始傳送傳真之前，您必須先輸入您的姓名與傳真（電話）號碼。此外，您也需要設定日期與時間。

一旦您輸入此資訊，它將自動出現在您傳送的每一頁傳真頁面之頂端。

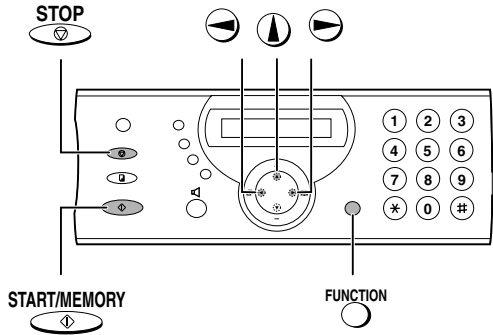

- 1** 按 **FUNCTION** 一下，再按 **▲** 兩下。

顯示屏顯示：

ENTRY MODE **↔**
(輸入模式)

- 2** 按 **▶** 一下。

OWN NUMBER SET **↔**
(設定本機號碼)

- 3** 按 **▶** 一下。

























































ENTER FAX #
(輸入傳真號碼)



4 按數字鍵輸入傳真號碼 (最多 20 位數)。

- 要在數字之間插入空格，請按 **#**。要輸入 +，請按 *****。
- 要清除錯誤，請按 。

5 按 **START/MEMORY**  將傳真號碼輸入記憶體中。**6** 按下代表每個英文字母的數字鍵 (如下圖所示) 來輸入您的姓名。最多可輸入 24 個字元。

範例：SHARP = 7777 44 2 777  7

SPACE = 	G = 	N =  	U =  
A = 	H =  	O =   	V =   
B =  	I =   	P = 	W = 
C =   	J = 	Q =  	X =  
D = 	K =  	R =   	Y =   
E =  	L =   	S =    	Z =    
F =   	M = 	T = 	

- ◆ 如需要連續輸入兩個使用同一按鍵的英文字母，請在輸入首個字母後按 。
- ◆ 要清除錯誤，請按 。
- ◆ 要輸入小寫英文字母，請按住該英文字母按鍵，直到小寫英文字母出現為止。要輸入下列符號，請重複按 **#** 或 *****：.: / ! " # \$ % & ' () * + , - : ; < = > ? @ [\] ^ _ ' { | } → ←

7 按 **START/MEMORY** 。

顯示屏顯示：

DATE&TIME SET 

(設定日期和時間)

8 按 **STOP**  返回日期和時間顯示。

設定日期和時間

日期與時間將會出現在顯示屏上，並打印在每個傳真頁面的頂端。請依下述設定日期與時間。

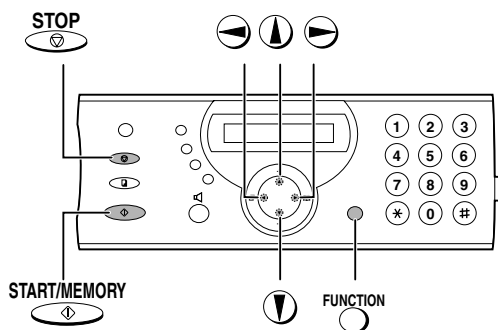
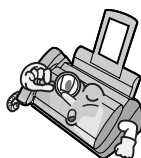

- 1** 按 **FUNCTION** 一下，再按 **▲** 兩下。

顯示屏顯示：

ENTRY MODE **↔**
(輸入模式)

- 2** 依次序按 **▶** 與 **▼** 一下。

DATE&TIME SET **↕**
(設定日期和時間)

- 3** 按 **▶** 一下。

顯示目前設定的日期
(範例)：

DATE 15-08-2004
(日期：2004 年 8 月 15 日)

- 4** 輸入代表日期的兩位數字 ([01] 至 [31])。

範例：5 日 **0** **5**



DATE 05-08-2004
(日期：2004 年 8 月 5 日)

- 要更正錯誤，請按 **◀** 將游標往回移至錯誤的地方，然後輸入正確的數字。

- 5** 輸入代表月份的兩位數字 (如 [01] 代表一月、[02] 代表二月、[12] 表示十二月，以此類推)。

範例：一月 0 1



DATE 05-01-2004

(日期：2004 年 1 月 5 日)

- 6** 輸入年份 (四位數字)。

範例：2004 2 0 0 4



TIME 12:19

(時間：12:19)

顯示屏上顯示目前設定的時間 (範例)：

- 7** 輸入代表小時的兩位數字 ([00] 至 [23]) 和代表分鐘的兩位數字 ([00] 至 [59])。

範例：9:25 0 9 2 5



05-JAN 09:25

(1 月 5 日 09:25)

- 8** 按  啟動時鐘。



ANTI JUNK #

(限制接收號碼)

- 9** 按  返回日期和時間顯示。

設定接收模式

您的傳真機具有以下四種接收模式：

FAX (傳真) 模式：

如果傳真機僅用來接收傳真，請選擇此模式。傳真機將自動接聽所有來電並接收傳真。

TEL (電話) 模式：

此模式最適用於接聽電話。也可用來接收傳真，但所有來電必須先拿起傳真機聽筒或連接至同一線路的電話分機之聽筒才可接聽。

TEL/FAX (電話/傳真) 模式：

此模式適用於接收傳真與接聽語音來電。當電話撥入，傳真機會偵測是否為語音來電 (包括手動撥號傳真) 或自動撥號傳真。如果是語音來電，傳真機將發出特殊鈴聲以提示您接聽電話。如果是自動撥號傳真，則傳真機將開始自動接收。

A.M. (留言機) 模式

當您外出但希望內建留言機能接聽所有來電時，請選擇此模式。傳真機將記錄留言並自動接收傳真信息。

設定接收模式

按 RECEPTION MODE  直到顯示屏上的箭頭指向所要的模式。

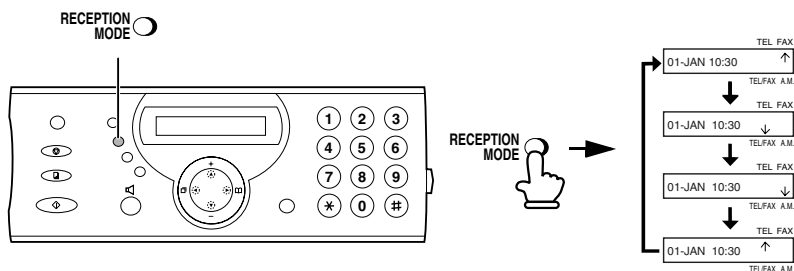

註：除非已錄製一般外出留言信息，否則您無法選擇「留言機」模式 (如第 25 頁所述)。

要取得更多有關在電話、電話/傳真及傳真模式中接收傳真的資訊，請參閱第 4 章接收傳真。要獲得有關使用「留言機」模式的更多資訊，請參閱第 2 章使用留言機。

調整音量

您可使用上下方向鍵來調整喇叭與響鈴音量。

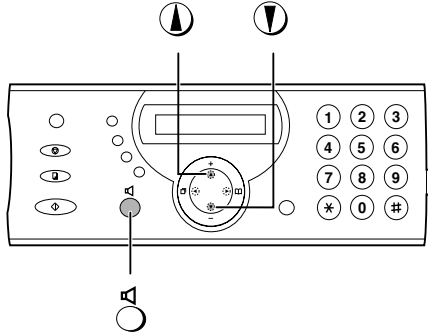

喇叭

1 按 。

2 按  或  直到顯示屏上顯示所需的音量。

- 再按  一次關閉喇叭。

響鈴

1 按  或 。

(確定並未按下 ，文件也未放入送紙器內。)

- 響鈴將以選定的音量響鬧一次，然後日期與時間將重新出現在顯示屏上。

顯示屏顯示：

RINGER: HIGH

(響鈴：  高)

RINGER: MIDDLE

(響鈴：  中)

RINGER: LOW

(響鈴：  低)

RINGER: OFF OK ?

(是否關閉響鈴？)

2 如果選擇 RINGER: OFF OK ? (是否關閉響鈴？)，請按 。

註：接收模式設為 TEL (電話) 時，即使關閉響鈴功能，傳真機仍會發出 LOW (低聲) 響鈴。

2. 使用留言機

內建的電話留言機讓您在外出時也可接收留言與傳真。



要使用留言機，您必須先錄製外出留言信息。您可在外出時透過將接收模式設定為留言機以開啟留言機。

錄製外出留言信息

外出留言信息 (OGM) 是留言機在接聽來電後播放的問候語，以告知來電者可以留言或傳送傳真。請執行以下步驟以錄製信息。

範例：

哈囉，這裏是 _____。現在無人接聽您的來電。請在嗶聲後留言或按下您傳真機的開始鍵以傳送傳真，謝謝。

1 依次序按 **REC/MEMO** 與 **▼** 一下。

顯示屏顯示：

OGM1(GENERAL) **↕**
(OGM1 [一般])

2 按 **▶** 一下。

• 如您已預先錄下一段信息，則可按

▶PLAY/HOLD 聆聽此段信息的內容。

LIFT HANDSET OR
(拿起聽筒 **▲** **▼** 筒或)

PLAY: PLAYBACK
(按播放鍵進行播放)

3 拿起聽筒。

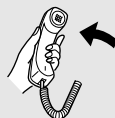

4 按 **START/MEMORY** 並對著聽筒講話以錄製信息。

- 外出留言信息的錄音時間可長達 60 秒。在錄音時，顯示屏上將會顯示剩餘的錄音時間。

5 錄音完成後，請將聽筒放回原處或按下 **STOP**。

聆聽外出留言信息

要聆聽外出留言信息，請執行上述程序中的步驟 1 與步驟 2，然後按下

▶**PLAY/HOLD**。請注意，您無法清除一般外出留言信息。如要變更信息內容，僅需重複錄音程序即可。

註：如果傳真機有連接電話分機，當電話分機在使用時，您將無法錄製、播放或刪除外出留言信息。

操作留言機

啟動留言機

要啟動留言機讓來電者留言，請按下 **RECEPTION MODE** 直到顯示屏上的箭頭指向 A.M. (留言機)。

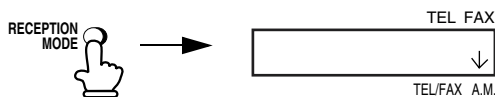

- ◆ 傳真機將會播放外出留言信息 (您可按下 **STOP** 停止播放)。
- ◆ 如未錄製外出留言信息，則無法將接收模式設定為留言機。

註：在留言機模式下，如接聽來電後靜音時間超過六秒，傳真機將自動切換至接收傳真模式。因此，如果來電者在留言時暫停六秒鐘以上，留言機將會中斷連線。

留言機模式下的響鈴次數 (Toll Saver [節省費用功能])

傳真機在留言機模式下接聽來電之響鈴次數取決於 Toll Saver (節省費用功能) 是否開啟，以及在該功能開啟的情況下您是否曾收到信息。

- ◆ Toll Saver (節省費用功能) 的起始設定為 ON (開啟)。

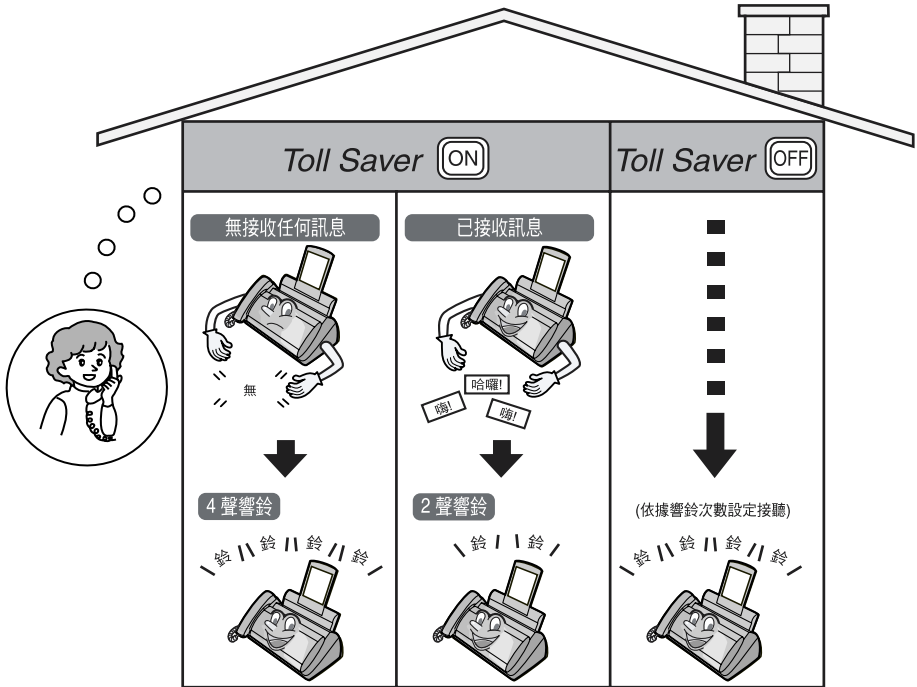

要關閉 Toll Saver (節省費用功能)，請參閱第 37 頁。

要調整 NUMBER OF RINGS (響鈴次數) 設定，請參閱第 59 頁。

聆聽收到的信息



在您回來時，顯示屏上將會顯示已錄製的信息數目。請執行以下步驟以聆聽信息。

1 按 。

- 如果您僅要聽取新的信息 (先前未聽取的信息)，請持續按住  鍵至少兩秒。

2 傳真機將會播放信息。

- 在播放每則信息時，顯示屏上將會簡略地出現信息的錄製日期與時間。如果未收到信息，顯示屏上將會出現 NO MESSAGES (無信息)。

- **重複**：要再次聽取信息，請在該信息播放完畢前按下 。要回到前一則信息，請在播放目前信息的前 3 秒內按下 。

- **略過**：要跳至下一則信息，請按下 。

註：如果您收到來電、拿起聽筒或按下 ，傳真機將會停止播放。

- ◆ 您可以打印已接收信息清單，其中將會顯示每則信息的接收日期與時間。請參閱第 76 頁。

清除收到的信息

在您聆聽收到的信息後，請務必將其清除，以免出現記憶體已滿的情況。

- ◆ **清除所有信息**：要清除所有信息，請依次按下 **FUNCTION** 與 **#**，然後再按

START/MEMORY。

- ◆ **清除一則信息**：要清除一則信息，請在播放該信息時按下 **#**。

錄製備忘

您可以為自己或傳真機的其他使用者錄製備忘。這些備忘將在您按下 **▶PLAY/HOLD** 鍵時，與所有來電留言信息一起播放。

1 依次序按 **●REC/MEMO** 與 **▶** 一下。

2 拿起聽筒，按 **START/MEMORY** 並對著聽筒講話。

3 錄音完成後，請將聽筒放回原處或按下 **STOP**。

錄取通話內容 (雙向錄音)

要錄取通話內容，請在您要錄音的談話過程中按住 **●REC/MEMO** 鍵。錄音完成後，請放開此鍵。按下 **▶PLAY/HOLD** 鍵可播放此段通話內容。

可選用的留言機設定

設定 ICM 時間

來電留言信息 (ICM) 是來電者在內建留言機上留給您的信息。留言機在出廠時已將每位來電者的留言長度設定為最大值 4 分鐘。如有需要，您可將此設定變更為 15 秒、30 秒或 60 秒。

1 依次序按 **FUNCTION** 與 **▼** 一下。

顯示屏顯示：

A.M. SETTING 
(留言機設定)

2 依次序按 **▶** 與 **▼** 一下。

RECORDING TIME 
(錄音時間)

3 按 **▶**。

4 按數字鍵 1 至 4 其中之一者來選擇需要的 ICM 錄音時間。

1 15 秒

3 60 秒

2 30 秒

4 4 分鐘

顯示屏上將會簡略地顯示您的選擇，然後顯示：

REMOTE CODE 
(遙距代碼)

5 按 **STOP**  返回日期和時間顯示。

留言機出現故障時的傳真模式

如果儲存來電留言信息的記憶體在您外出時已滿，則留言機將無法再錄取信息。發生這種情況時，您可使用 ON A.M. FAILURE (留言機出現故障) 設定來選擇留言機是否將接收模式切換至傳真模式：

- ◆ YES (是，切換至傳真模式)：接收模式將切換至傳真模式，留言機可繼續自動接收傳真。套用此設定後，您仍可透過遙距指令聽取信息，然後將其清除 (請參閱 *遙距操作*，第 37 頁)。







- ◆ NO (否, 不切換至傳真模式)：留言機將在 20 聲響鈴後接聽來電，然後等待接收遙距指令。大多數來電者會在留言機接聽之前掛斷電話；可是，如果是您從遙距位置呼叫留言機，則您可靜待留言機接聽電話，聽取信息，然後清除信息 (請參閱 *遙距操作*，第 37 頁)。

起始設定值為 NO (否)。如果您要將其設定為 YES (是)，請依下述按下面板鍵：

- | | |
|--|--|
| 1 依次序按  與  一下。 | 顯示屏顯示：
<div style="border: 1px solid black; padding: 2px; display: inline-block;">A.M. SETTING </div>
(留言機設定) |
| 2 按  一下，再按  兩下。 | <div style="border: 1px solid black; padding: 2px; display: inline-block;">ON A.M. FAILURE </div>
(留言機出現故障) |
| 3 按  。 | <div style="border: 1px solid black; padding: 2px; display: inline-block;">1=YES, 2=NO</div>
(1=是, 2=否) |
| 4 按 ① 選擇 YES (是, 切換至傳真模式)，
或按 ② 選擇 NO (否)。 | 顯示屏上將會簡略地顯示您的選擇，然後顯示：
<div style="border: 1px solid black; padding: 2px; display: inline-block;">OGM ONLY MODE </div>
(僅限 OGM 模式) |
| 5 按  返回日期和時間顯示。 | |

僅限 OGM 模式



如有需要，可關閉來電留言信息錄音功能。在這種情況下，傳真機將播放您的外出留言信息，但來電者無法留言。(傳真機仍然可接收透過自動撥號功能傳送的傳真)。

- | | |
|---|--|
| 1 依次序按  與  一下。 | 顯示屏顯示：
<div style="border: 1px solid black; padding: 2px; display: inline-block;">A.M. SETTING </div>
(留言機設定) |
| 2 依次序按  與  一下。 | <div style="border: 1px solid black; padding: 2px; display: inline-block;">OGM ONLY MODE </div>
(僅限 OGM 模式) |

3 按 。

1=YES, 2=NO

(1=是, 2=否)

4 按  啟動「僅限 OGM 模式」，
或按  關閉此模式。

顯示屏上將會簡略地顯示
您的選擇，然後顯示：

TOLL SAVER

(節省費用功能)

5 按  返回日期和時間顯示。

轉接功能

透過轉接功能，留言機將會在每次接收來電留言信息時，即自動撥打您指定的號碼。這樣一來，即使您身處異地亦可立即聽取來電留言信息。

要使用轉接功能，您必須先設定希望留言機撥打的號碼 (轉接號碼)，然後錄製您在遙距位置接聽電話時要播放的轉接信息。

如果您想在外出時使用轉接功能，請將其開啟。如果您在回來後不想再使用轉接功能，請將其關閉。

設定轉接號碼

要使用轉接功能，您必須先為留言機設定要撥打的號碼 (轉接號碼)。

1 依次序按  與  一下。

顯示屏顯示：

A.M. SETTING

(留言機設定)

2 按  一下，再按  四下。

TRANSFER TEL #

(轉接電話號碼)

3 按 。

ENTER TEL #

(輸入電話號碼)



4 按數字鍵輸入轉接號碼。

- 要在號碼的任何兩個數字間插入暫停，請按下 。

5 按 。**6 按  返回日期和時間顯示。****錄製轉接信息**

在您接聽電話時，傳真機會播放轉接信息，並告知您此為轉接來電。轉接信息最長可達 15 秒鐘。要錄製轉接信息，請執行以下步驟。以下是一個範例：

哈囉，這是 (您的姓名) 的轉接來電。現在請輸入您的遙距代碼。



1 按  一下，再按  兩下。

顯示屏顯示：

(OGM2 [轉接])

2 按  一下。

- 如您已預先錄下一段信息，則可按

 聽取信息內容，或按  **DELETE**

將其刪除。



3 拿起聽筒。

4 按 **START/MEMORY**  並對著聽筒講話以錄製信息。

- 轉接信息最長可達 15 秒鐘。在錄音時，顯示屏上將會顯示剩餘的錄音時間。

5 錄音完成後，請將聽筒放回原處或按下 **STOP** 。

檢查或清除轉接信息

要檢查或清除轉接信息，請執行上述的步驟 1 與步驟 2，然後按 **▶PLAY/HOLD**  檢查信息內容，或按 **#**  將其刪除。
DELETE

開啟與關閉轉接功能

如果您在外出時要使用轉接功能，請按照以下步驟將其開啟：

1 依次序按 **FUNCTION**  與 **▼**  一下。

顯示屏顯示：



A.M. SETTING 
(留言機設定)

2 按 **▶**  一下，再按 **▲**  三下。

TRANSFER FUNC 
(轉接功能)

3 按 **▶** 。

1=YES, 2=NO
(1=是, 2=否)

4 按 **①**  啟動此功能。
(按 **②**  關閉此功能。)

顯示屏上將會簡略地顯示您的選擇，然後顯示：

ON A.M. FAILURE 
(留言機出現故障)

5 按 **STOP**  返回日期和時間顯示。

6 傳真機在每次接收來電留言信息時，將撥打您設定的轉接號碼。接聽時您將會聽到預先錄製的轉接來電信息。請使用電話撥號盤輸入 **(#)**、遙距代碼 (請參閱第 37 頁) 及 **(#)**。傳真機將播放您的信息。

- 您亦可執行本章後述*遙距操作*中的任何遙距操作 (請參閱第 37 頁)。

註：如果您在轉接來電後掛上聽筒，傳真機不會立即恢復正常操作。如果您要傳真機在轉接來電後立即接聽來電，請在掛斷電話之前輸入 **(*)** 兩次 (如果您要在播放信息時掛斷電話，請先輸入 **(0)** 與 **(#)** 停止播放，然後再輸入 **(*)** 兩次)。

略過響鈴

透過此功能，特定的來電者可使用按鍵式電話略過留言機的外出留言信息，而且留言機並會發出特殊的鈴聲向您提示來電。當您在留言機附近，卻只想與特定來電者通話時，此功能將很有用 (所有其他來電將由留言機接聽)。

設定略過代碼

要略過留言機，來電者必須透過本身電話輸入 3 位數的略過代碼。此代碼在出廠時已設定為「009」。如果您要變更此代碼，請依下述按下面板鍵。

重要事項！請確定略過代碼與遙距操作所使用的遙距代碼不相同。

1 依次序按 **FUNCTION** 與 **(▼)** 一下。

顯示屏顯示：

A.M. SETTING **(↕)**
(留言機設定)



2 按  一下，再按  三下。

OVERRIDE CODE 

(略過代碼)

3 按  。

4 按數字鍵輸入 3 位數的略過代碼。

5 按  儲存略過代碼，然後按  返回日期和時間顯示。

略過留言機

您的來電者應按照以下步驟略過留言機。

1 來電者透過按鍵式電話致電您的傳真機。當傳真機開始播放外出留言信息時，來電者應在其電話上按下  鍵。

- 來電者將聽到短促的嗶聲，然後傳真機會停止播放外出留言信息。

2 來電者應在本身電話上按下適當的鍵來輸入略過代碼與  。

- 如果輸入了錯誤的代碼，來電者將聽到四響嗶聲。此時，來電者必須在 10 秒內重新輸入正確代碼，否則線路將被切斷。

3 傳真機將發出特殊鈴聲。此時您可拿起聽筒接聽來電。(請注意，同一線路上的分機將不會發出鈴聲)。

- 如果您在 30 秒內沒有接聽，此時會再次播放外出留言信息，來電者即可留言。

遙距操作

您可在外出時從任何按鍵式電話致電傳真機，並使用遙距指令播放您的信息。同時，您也可使用這些指令來變更接收模式及其他設定值。

遙距代碼

要存取傳真機以執行遙距操作，您必須先輸入遙距代碼。遙距代碼在出廠時已設定為「001」。如果您要使用不同的代碼，請執行以下步驟：

1 依次序按 **FUNCTION** 與 **▼** 一下。

顯示屏顯示：

A.M. SETTING **↕**
(留言機設定)

2 按 **▶** 一下，再按 **▼** 兩下。

REMOTE CODE **↕**
(遙距代碼)

3 按 **▶**。

4 按數字鍵輸入 3 位數的遙距代碼。

5 按 **START/MEMORY** 儲存遙距代碼，然後按 **STOP** 返回日期和時間顯示。

Toll Saver (節省費用)

致電傳真機聽取信息時，它將在兩聲響鈴 (如果已接收至少一則信息) 或四聲響鈴 (如果沒有接收任何信息) 後接聽。

這可讓您節省電話費用，特別是在撥打長途電話時。如果傳真機在第二聲響鈴後沒有接聽，您可在它接聽之前先掛斷，如此即可節省該通電話的費用。

如果您不想使用節省費用功能，您可執行以下步驟將其關閉。在這種情況下，傳真機將在 NUMBER OF RINGS (響鈴次數) 設定中設定的響鈴次數之後接聽電話 (請參閱 **變更響鈴次數**，第 59 頁)。

1 依次序按  與  一下。

顯示屏顯示：



A.M. SETTING 
(留言機設定)

2 按  一下。

TOLL SAVER 
(節省費用)

3 按  一下。

1=YES, 2=NO
(1=是, 2=否)

4 按  啟用節省費用功能，
或按  將之關閉。

顯示屏上將會簡略地顯示
您的選擇，然後顯示：

RECORDING TIME 
(錄音時間)

5 按  返回日期和時間顯示。

擷取信息

1 透過按鍵式電話致電傳真機。在外出留言信息開始播放時，按下電話上的  。

- 您將會聽到一次短促的嗶聲，然後外出留言信息將停止播放。

2 輸入您的遙距代碼，然後按下  。

- 您將聽到一連串嗶聲，次數與錄下的信息數相等，或聽到一聲較長的嗶聲 (如果已接收四則以上信息)。然後，留言機將開始播放信息，並在每則信息結束時發出一聲嗶聲。在所有信息播放完畢後，您將聽到一聲較長的嗶聲。
- 如果沒有接收任何信息，您將聽到一聲短促的嗶聲。此時您可以選擇掛斷，或執行下節 *其他遙距操作* 中所述的任何一項操作。

3 在播放信息時，您可以執行下列任何一項操作：

- **重複**：要再次聽取信息，請在信息結束前按下電話的 **2** 與 **#**。要回到前一則信息，請在播放目前信息的前 3 秒內按下 **2** 與 **#**。
- **往前略過**：要跳至下一則信息，請按下電話的 **5** 與 **#**。
- **停止**：要停止播放，按下電話的 **0** 與 **#**。在此之後，您可輸入下節 *其他遙距操作* 中所述的任何指令。
- **播放新信息**：如只要聽取新信息，請先按下 **0** 與 **#** 停止播放，然後再按下 **6** 與 **#**。
- **清除一則信息**：要清除目前聽取中的信息，請在該信息結束前按下 **3** 與 **#**。

4 聽完信息後，您可執行以下任何一項操作：

- **清除所有信息**：請依次按下 **3**、**3** 與 **#**。
- **重複播放**：請按下 **7** 與 **#**。
- **執行其他操作**：您可輸入下節 *其他遙距操作* 中所述的任何指令。
- **掛斷**：如果您沒有先清除信息，則系統將儲存信息，所有新信息將錄在其後。如果您要傳真機立即恢復正常的操作，請按 ***** 兩下後再掛斷 (在某些情況下，特別是在使用轉接功能時，在您掛斷後的一或兩分鐘內，傳真機可能無法接聽新的來電，除非您先按 ***** 兩下)。

註：當接收模式設為傳真時，您亦可致電傳真機執行遙距操作。在這種情況下，致電傳真機時請在它接聽後 (聽到傳真信號之前) 立即按下 **(#)**，然後繼續上述步驟 2 之後的程序。

註解：

- ◆ 傳真機接受遙距指令後，您將聽到一次嗶聲。如果輸入的指令不正確，您將聽到四次嗶聲。如輸入錯誤，請重新輸入正確指令。
- ◆ 在輸入指令時，每個數字之間的暫停時間不要超過 10 秒鐘。否則，您將聽到 4 次嗶聲的錯誤信號，而之前輸入的數字也將被清除。在這種情況下，請重新輸入指令。
- ◆ 如果您在暫停時間超過 10 秒後才輸入指令，或在輸入遙距代碼時出現兩次錯誤，則線路將被切斷。(這樣可防止未經授權者嘗試盜取您的遙距代碼)。

其他遙距操作

在聽取信息後，您可按下電話的相應按鍵來執行下列任何操作。

注意：播放信息時，您無法輸入下列指令。如果您不想等到播放結束後才輸入指令，您可以先按下 **(0)** 與 **(#)** 停止播放，然後再輸入指令。

變更傳真接收模式

按以下按鍵選擇新的接收模式：

◆ **留言機模式：** **(8)**、**(1)** 與 **(#)**。

◆ **傳真模式：** **(8)**、**(2)** 與 **(#)**。

◆ **電話模式：** **(8)**、**(3)** 與 **(#)**。

注意：如果您選擇電話模式，您將無法再變更接收模式。

◆ **電話/傳真模式：** **(8)**、**(4)** 與 **(#)**。

錄製新的外出留言信息

1 按電話上的 **4** 與 *****。

2 聽到短促的嗶聲後，您即可對著聽筒講話以錄製新信息。

- 信息最長可達 15 秒。在 15 秒後 (如留言機在您講話後未有再偵測到任何聲音，時間將會更短)，您將聽到一次嗶聲，然後系統將會播放新信息。

開啟或關閉轉接功能

要開啟轉接功能：按電話上的 **9**、**1** 與 **#**。

要關閉轉接功能：按電話上的 **9**、**2** 與 **#**。

變更轉接電話號碼

1 按電話上的 **9**、**0** 與 **#**。

2 請在聽到一次短促的嗶聲後輸入新電話號碼。完成後請按 **#**。

- 要在號碼的任何兩個數字間插入暫停，請按 *****。

錄製新的轉接信息

1 按電話上的 **9**、**3** 與 **#**。

2 聽到短促嗶聲後，即可對著聽筒講話以錄製新信息。

- 轉接信息的時間已固定為 15 秒。在 15 秒後 (如留言機在您講話後未有再偵測到任何聲音，時間將會更短)，您將聽到一次嗶聲，然後系統將會自動播放新信息。

錄製備忘

您可為自己或其他使用者錄製備忘。在聆聽來電留言信息時，系統將會播放此備忘錄音。

1 按電話上的 ***** 與 **#**。

2 聽到短促的嗶聲後，即可對著聽筒講話以錄製新的備忘。

3 錄音完成後，請按下電話上的 **0** 與 **#**。

- 如果傳真機沒有偵測到任何聲音，它將自動停止錄音。

僅限 OGM 模式

要開啟「僅限 OGM 模式」：請按 **1** 與 **1**，然後再按電話上的 **#**。
(系統將播放您的外出留言信息，但來電者無法留言。至於透過自動撥號功能傳送的傳真，則仍然可以接收。)



要關閉「僅限 OGM 模式」：請按 **1** 與 **2**，然後再按電話上的 **#**。

3. 傳送傳真

可傳送的文件

尺寸與重量

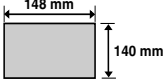
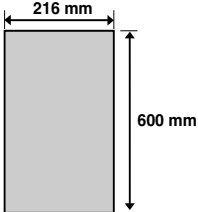
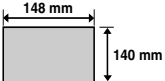
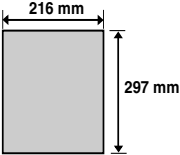
送紙器中可裝入的文件尺寸與重量，取決於一次放入一頁或一次放入多頁。

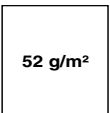
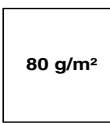
一次放入一頁：		一次最多放入 10 頁：	
最小尺寸	最大尺寸	最小尺寸	最大尺寸
			
最小重量	最大重量	最小重量	最大重量
			

註：傳真機將不會掃描文件邊緣的文字或圖形。

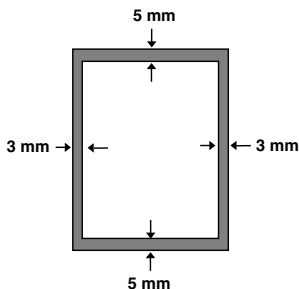

傳真機將不會掃描陰影區域內的文字。

註：掃描全闊度小於 210 毫米的文件。

其他限制

- ◆ 掃描器無法識別黃色、淺黃綠色或淺藍色墨水。
- ◆ 在將文件送入送紙器之前，文件上的墨水、膠水與塗改液必須均已乾透。
- ◆ 在將文件放入送紙器之前，所有的迴紋針、釘書針與圖釘均須先從文件上取下。否則，傳真機可能會因而損壞。
- ◆ 凡是有修補過、含膠帶、撕破、小於最小尺寸、可複寫、易弄髒或表面光滑的文件均應事先複印，然後再將複印本放入送紙器中。

放入文件

送紙器一次最多可放入 10 頁紙張。這些紙張將從最下面的那一頁開始自動送入傳真機中。

- ◆ 如果您要傳送或複印超過 10 頁的文件，您可在掃描最後一頁的前一刻，將附加的紙張小心地輕放在送紙器中。請勿嘗試強行推入紙張，因為這樣可能會發生重疊送紙或夾紙的情況。
- ◆ 如果文件中有幾頁較大或較厚，需要逐次一張裝入，請在掃描前一頁的同時將下一頁放入送紙器中。請輕輕地放入以免造成重重送紙。

1 調整導紙板以配合文件寬度。

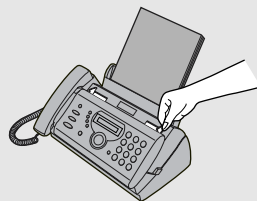

2 將文件正面朝下插入送紙器中。文件的頂端邊緣必須先放入送紙器內。

- 顯示屏上將會出現 READY TO SEND (傳送就緒) 信息。

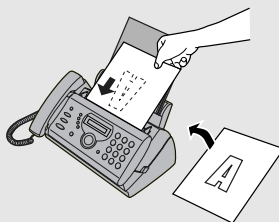

- 3** 請按照以下的解像度與對比度說明，調理解像度與/或對比度設定值，然後如第 47 頁所述，撥打接收方傳真機號碼。

調理解像度與對比度

如有需要，可在傳送文件之前先調理解像度與對比度。

解像度的預設值為 STANDARD (標準)，而對比度的預設值為 AUTO (自動)。



每當您不想使用預設值時，您必須調整設定值。



註：解像度與對比度的設定值僅適用於傳送文件，對於接收文件則無效。

解像度設定值

- | | |
|-------------------------|---|
| STANDARD (標準) | 一般文件，請使用 STANDARD (標準) 設定值。這是最快且最經濟的文件傳送方式。 |
| FINE (細緻) | 文件文字較細小或有精細圖形，請使用 FINE (細緻) 設定值。 |
| SUPER FINE (超細緻) | 文件文字極小或有極精細圖形，請使用 SUPER FINE (超細緻) 設定值。 |
| HALF TONE (半色調) | 相片與插圖，請使用 HALF TONE (半色調) 設定值。傳真機會以 64 級灰度傳送文件原稿。 |

對比度設定值

AUTO (自動)

一般文件，請使用 AUTO (自動) 設定值。

DARK (深色)

文字模糊的文件，請使用 DARK (深色) 設定值。

1 放入文件。

- 您必須先裝入文件，然後才可以調整解像度與對比度。

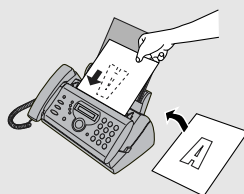

2 按 一下或多下直到顯示屏上出現所要的解像度與對比度設定值。

- 第一次捲動解像度設定值清單時，對比度設定值 AUTO (自動) 將出現在每個解像度設定值的旁邊。第二次捲動清單時，顯示屏上出現對比度設定值將會為 DARK (深色)。

顯示屏顯示：



註：如果您要使用 SUPER FINE (超細緻) 解像度傳送文件，則接收方傳真機也必須具有相同的解像度。否則，您的傳真機將自動使用另一個最適用的有效設定值。

透過一般撥號傳送傳真

若是一般撥號，請拿起聽筒(或按 )，然後按數字鍵撥號。

- ◆ 如果有人接聽，則您可先透過聽筒與他們通話，然後才傳送傳真(如果您已按下  ，則必須拿起聽筒才可進行通話。)
- ◆ 一般撥號容許您聆聽線路信號並確定對方的傳真機是否有回應。

1 放入文件。

- 如有需要，按  設定解像度與/或對比度。

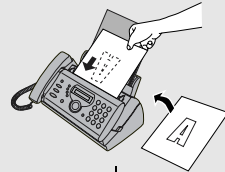

READY TO SEND
(傳送就緒)

2 拿起聽筒或按 。聆聽撥號音。



3 按下數字鍵，撥打接收方傳真機號碼。



4 等候電話接通。取決於接收方傳真機的設定值，您將聽到傳真信號或對方接聽的聲音。

- 如果電話由對方接聽，請其按下傳真機的開始鍵(如果您已按下  ，請拿起聽筒與他們通話)。這樣接收方的傳真機便會發出傳真信號。

5 聽到傳真信號時，請按下 **START/MEMORY** 。掛上聽筒。



- 如果成功完成傳送，傳真機會嗶一聲。
- 如果發生錯誤，傳真機會發出嗶聲三次，並打印執行報告告知您問題所在 (請參閱第 78 頁)。

註：

如果傳真未成功，且顯示屏顯示 DOCUMENT JAMMED (文件夾紙)，請依第 90 頁的說明取出文件。(如果在您嘗試傳送文件時傳真機未正確回應，便可能發生這種情況。)

透過自動撥號傳送傳真

您最多可在傳真機中儲存 40 個自動撥號的傳真或電話號碼。

- ◆ 按  直到顯示屏出現所需的號碼，然後再按 **START/MEMORY** ，即可自動撥打號碼。

將傳真與電話號碼儲存為自動撥號號碼

1 依次序按 **FUNCTION**  與  一下。



顯示屏顯示：

<NEW NUMBER> 
(<新號碼 >)

2 按  一下。

ENTER FAX #
(輸入傳真號碼)

























































3 按數字鍵輸入傳真或語音號碼。您最多可輸入 32 個數字。(註：不能輸入空格。)

- 要清除錯誤，請按 .
- 如果為了存取某項特殊服務或接通外線而需要在任何數字之間插入暫停，請按 **FUNCTION** 。暫停將以連字號顯示 (每次暫停將持續兩秒)。您可在同一列內輸入多個暫停。



4 按 **START/MEMORY** 

5 按下代表每個英文字母的數字鍵 (如下圖所示) 來輸入姓名。您最多可輸入 15 個字元。(如果您不想輸入姓名, 請直接跳至步驟 6)。

範例: SHARP = 7777 44 2 777  7

SPACE = 	G = 	N =  	U =  
A = 	H =  	O =   	V =   
B =  	I =   	P = 	W = 
C =   	J = 	Q =  	X =  
D = 	K =  	R =   	Y =   
E =  	L =   	S =    	Z =    
F =   	M = 	T = 	

◆ 如要輸入的連續兩個英文字母均需要使用同一按鍵, 請在輸入首個字母後按 。

◆ 要輸入小寫英文字母, 請按住該英文字母按鍵, 直到小寫英文字母出現為止。要輸入下列符號, 請重複按  或  : . / ! " # \$ % & ' () * + , - . ; < = > ? @ [\] ^ _ ' { | } → ←

6 按 **START/MEMORY** 

顯示屏顯示:

(< 新號碼 >)

7 回到步驟 2 儲存其他號碼, 或按 **STOP**  返回日期和時間顯示。

註: 傳真機使用的是鋰電池, 可在電源關閉時將自動撥號號碼與其他設定的資訊儲存在記憶體中。在電源關閉時, 所消耗的主要是電池電力。如果電源持續關閉, 則電池的使用壽命大約為 5 年。如果電池電能已耗盡, 請洽詢您的經銷商或零售商將其更換。請勿嘗試自己更換。

編輯與清除自動撥號號碼

如果您要變更之前儲存的自動撥號號碼或清除號碼，請執行以下步驟：

1 依次序按 **FUNCTION** 與 **▶** 一下。

顯示屏顯示：

<NEW NUMBER> **↕**
(<新號碼 >)

2 按 **▲** 或 **▼** 直到所要編輯或清除的號碼出現在顯示屏上。

3 按 **▶** 一下。

1=EDIT, 2=CLEAR
(1=編輯, 2=清除)

4 選擇 **EDIT (編輯)** 或 **CLEAR (清除)**：

EDIT: (編輯:) **①**

CLEAR: (清除:) **②**

- 如果您選擇了 **CLEAR (清除)**，請跳至步驟 8。

5 如果選擇了 **EDIT (編輯)**，請根據需要變更號碼。

- 按 **◀** 或 **▶** 將游標移至要變更的數字，然後輸入新的數字。新的數字將取代舊的數字。
- 如果您不想變更號碼，請直接跳至步驟 6。

6 按 **START/MEMORY**。

7 根據需要變更姓名。

- 按 **◀** 或 **▶** 將游標移至您要變更的字母，然後重複按對應的數字鍵，直到顯示屏上出現所需的字母 (請參閱第 49 頁的步驟 5)。新的英文字母將取代舊的英文字母。
- 如果您不想變更姓名，請直接跳至步驟 8。

8 按 **START/MEMORY** 。

9 回到步驟 2 編輯或清除其他號碼，或按 **STOP**  返回日期和時間顯示。

使用自動撥號號碼



一旦儲存了傳真或電話號碼，您即可使用它傳送傳真或撥打電話。

1 如果要傳送傳真，請放入文件。

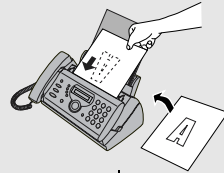
- 如有需要，按 **RESOLUTION**  設定解像度與/或對比度。



READY TO SEND
(傳送就緒)

2 按  (或 ) 直到顯示屏上出現對方姓名 (如未儲存姓名，則顯示號碼)。

3 如果要傳送傳真，請按 **START/MEMORY** 。撥號並開始傳送。

- 如果成功完成傳送，傳真機響一聲。
- 如果發生錯誤，傳真機會發出響聲三次，並打印執行報告告知您問題所在 (請參閱第 78 頁)。

如果要撥打電話，請拿起聽筒。開始撥號。

透過直接按鍵撥號傳送傳真

您也可以使用數字鍵來輸入完整的號碼，然後按 **START/MEMORY**  開始撥號。如果您無需先在傳真前和對方通話，您可以使用此方法撥打完整的號碼。

1 放入文件。

- 如有必要，按 **RESOLUTION**  設定解像度與/或對比度。

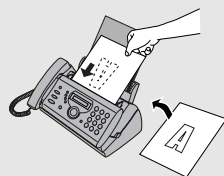

READY TO SEND

(傳送就緒)

2 按數字鍵輸入接收方傳真機號碼。

- 如果為了存取某項特殊服務或接通外線而需要在任何數字之間插入暫停，請按 **FUNCTION** 。暫停將以連字號顯示 (每次暫停將持續兩秒)。您可在同一列內輸入多個暫停。

3 查看顯示屏。如果顯示屏上顯示的接收方傳真機號碼正確，請按 **START/MEMORY** 。

- 如果號碼不正確，請按 **STOP**  退一格並逐一清除數字，然後重新輸入正確的數字。

重撥

您可自動重撥最後一次撥打的號碼。此步驟可用來傳送傳真或撥打電話。

1 如果要傳送傳真，請放入文件。

- 如有必要，按 **RESOLUTION**  設定解像度與/或對比度。

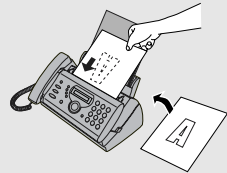

READY TO SEND

(傳送就緒)

2 按 一下。顯示屏上將出現 <REDIAL> (<重撥>)，然後出現最後撥出的號碼。確定顯示的號碼是您要撥出的號碼。

3 如果要傳送傳真，請按 **START/MEMORY** 。撥號並開始傳送。

如果要撥打電話，請拿起聽筒。傳真機將開始撥號。

註：

如果傳真未成功，且顯示屏顯示 DOCUMENT JAMMED (文件夾紙)，請依第 90 頁的說明取出文件。(如果在您嘗試傳送文件時其他傳真機未正確回應，便可能發生這種情況。)

自動重撥

如果您在線路繁忙時使用自動撥號功能 (包括直接按鍵撥號) 傳送傳真，則傳真機將自動重撥該號碼。傳真機會每隔五分鐘重複撥號三次。在此期間，顯示屏上將出現 RECALLING (重撥)，之後會出現一個指派給該傳真作業的兩位數字。出現此信息時，您無法撥打任何號碼。

- ◆ 要停止自動重撥，請按 。
- ◆ 在某些情況下 (例如對方直接接聽電話)，自動重撥可能在傳真機嘗試重撥兩次之前就停止。

誤差修正模式

傳真機已設定為在接收方打印傳真之前，先自動更正由於電話線路雜訊而導致的任何傳送失真。此功能稱為誤差修正模式 (ECM)。ECM 適用於傳送與接收情況，但僅在對方傳真機亦具有 ECM 功能時方為有效。

當電話線路上有許多雜訊時，您可能會發現啟用了 ECM 功能的傳輸時間較平常更久。如您想要使傳輸更快速，可嘗試關閉 ECM。

- 1** 依次序按  與  一下。

顯示屏顯示：

OPTION SETTING 
(選項設定)

- 2** 按  一下後再按  四下。

ECM MODE 
(ECM 模式)

- 3** 按  一下。

1=YES, 2=NO
(1=是，2=否)

- 4** 按 **1** 選取 YES (自動) 或按 **2** 選取 NO (手動)。

顯示屏上將會簡略地顯示您的選擇，然後顯示：

RECEIVE RATIO 
(接收比例)

- 5** 按  返回日期和時間顯示。

透過記憶體傳送傳真

您可以將文件掃描至傳真機記憶體中，再透過記憶體傳送功能傳真文件。這樣可提高傳送速度，並容許您在單一作業中將傳真傳送至多個接收點。在傳送結束後，文件將會自動從記憶體中清除。

廣播傳送 (將傳真傳送至多個接收點)

此功能容許您僅執行一項作業即可將同一份傳真傳送至 20 個不同接收點。

- ◆ 在將傳真傳送至多個接收點時，您僅可使用自動撥號號碼撥打對方的傳真機號碼。

1 放入文件。

- 如有需要，按 **RESOLUTION**  設定解像度與/或對比度。

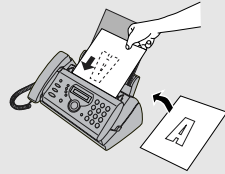

2 按 **START/MEMORY** .

3 按 (或) 直到顯示屏上出現對方姓名 (如未儲存姓名，則顯示號碼)。

4 按 選擇號碼。

5 重複步驟 3 和 4 選擇要傳送傳真的其他接收點 (最多 20 個)。

- 要檢查已選取的接收點，請按  捲動瀏覽。要刪除接收點，捲動至該接收點，再按 **STOP** .





6 準備好開始傳送時，按 。

- 廣播傳送完成後，傳真機將自動打印 Transaction Report (執行報告)。請檢查報告中的「Note (附註)」欄以查看是否有任何接收點標記為「Busy (線路繁忙)」，或是否標有通訊錯誤代碼。若出現上述情況，請再次將文件傳送至該接收點。

記憶體傳送



您亦可透過記憶體傳送傳真至單一接收點。在傳送至經常線路繁忙的接收點時，此功能為您提供極大的便利：您無需等待作業完成便可取走文件原稿，亦可騰出送紙器空間來進行其他作業。

要透過記憶體傳送，請放入文件，按 ，然後使用下列其中一種方式撥號：

- ◆ 按數字鍵輸入傳真號碼，再按 。
- ◆ 重複按  選擇自動撥號號碼，再按 。
- ◆ 按  一下，選擇上一次撥出的號碼，再按 。

如記憶體已滿...

在掃描文件時，如記憶體已滿，顯示屏上將會交替出現 MEMORY IS FULL (記憶體已滿) 與 SEE MANUAL (請參閱操作手冊) 信息。

- ◆ 如果您想要傳送的文件頁數已達到記憶體的儲存上限，請按 。
剩餘的頁面將會從送紙器退出。傳送結束後，記憶體中的內容將被清除，您便可以傳送其餘頁面了。此外，您可能需要傳送那些在掃描時剛好碰到記憶體已滿這種狀況的頁面。
- ◆ 如果要取消整個傳送作業，請按 。

4. 接收傳真

使用電話/傳真模式

要選擇電話/傳真模式，請按

RECEPTION MODE ○ 直到顯示屏上的箭

頭指向 TEL/FAX (電話/傳真)。

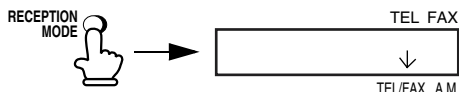
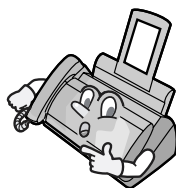

當接收模式設定為電話/傳真時，傳真機會在兩聲響鈴後自動接聽所有來電。在接聽後，傳真機會監聽線路約五秒鐘，以查看對方是否正在傳送傳真信號。

- ◆ 如果傳真機偵測到傳真信號 (這表示來電為自動撥號傳真)，則會自動開始接收傳真。
- ◆ 如果傳真機沒有偵測到傳真信號 (這表示來電為語音來電或手動撥號傳真)，則會響鈴 15 秒鐘 (稱為虛擬響鈴) 以提示您接聽來電。如果您沒有在 15 秒鐘內接聽，傳真機將傳送傳真信號到對方的傳真機，讓來電者可於必要時手動傳送傳真。

註：只有傳真機才可以透過虛擬響鈴來提示您接聽語音電話或接收手動撥號傳真。連接在同一線路上的電話分機在連接傳真機接聽來電後將不會響鈴。

電話/傳真模式的虛擬響鈴時間

如有需要，您可變更電話/傳真模式的虛擬響鈴時間。

1 依次序按 FUNCTION 與 一下。

顯示屏顯示：

OPTION SETTING

(選項設定)





2 按  一下後再按  四下。

PSEUDO RING 
(虛擬響鈴)

3 按  一下。

1=15 SECONDS
(1=15 秒)

4 按以下所示輸入所需時間：

- | | | |
|---|-------------|-------|
|  | 15 SECONDS | 15 秒 |
|  | 30 SECONDS | 30 秒 |
|  | 60 SECONDS | 60 秒 |
|  | 120 SECONDS | 120 秒 |

顯示屏上將會簡略地顯示您的選擇，然後顯示：

DUPLEX RINGING 
(雙音辨號)

5 按  返回日期和時間顯示。

使用留言機模式

要選擇留言機模式，請按下 RECEPTION MODE ，直到顯示屏上的箭頭指向 A.M. (留言機)。

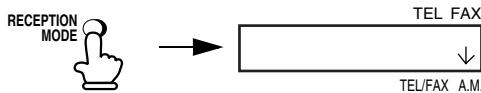

在留言機模式中，傳真機將自動接聽留言與接收傳真。請參閱第 2 章以取得更多詳細資訊。

使用傳真模式

要選擇傳真模式，請按

RECEPTION MODE  直到顯示屏上的箭頭指向 FAX (傳真)。

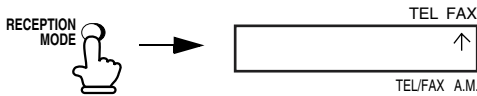

當接收模式設定為傳真時，傳真機將會在兩聲響鈴後自動接聽所有來電，並開始接收傳真。

- ◆ 如果您在傳真機接聽之前拿起聽筒，則您可與對方通話與/或接收傳真 (如第 60 頁的 *使用電話模式*)。

2 聲響鈴

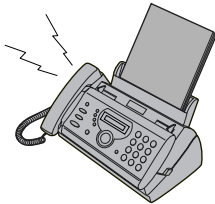

接收傳真

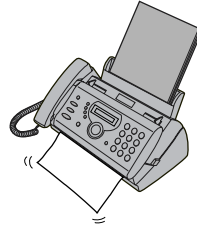

變更響鈴次數

如有需要，您可變更傳真機在傳真和電話/傳真模式下接聽來電之響鈴次數。您可選擇從 2 至 5 的任何數字。

1 依次序按  與  一下。

顯示屏顯示：

OPTION SETTING 

(選項設定)

2 按  一下。

NUMBER OF RING 
(響鈴次數)

3 按  一下。

ENTER (2-5) (2)
(輸入 [2-5] [2])

4 輸入所要的響鈴次數 (從 2 至 5 的任何數字)。

顯示屏上將會簡略地顯示您的選擇，然後顯示：

範例：響鈴 3 次 

FAX REMOTE # 
(遙距傳真代碼)

5 按  返回日期和時間顯示。

使用電話模式



要選擇電話模式，請按 RECEPTION MODE  直到顯示屏上的箭頭指向 TEL (電話)。

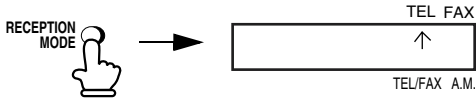

在接收模式設定為電話時，您必須拿起傳真機或連接至同一線路的電話分機之聽筒，才可接聽所有來電。

使用傳真機聽筒接聽

- 1 在傳真機響鈴時拿起聽筒。

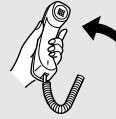

- 2 如果您聽到傳真信號，請等待顯示屏上顯示 RECEIVING (正在接收) 信息後，再將聽筒放回原處。



RECEIVING
(正在接收)

註：如果您已將接收傳真信號設定值 (第 62 頁) 設為 NO (否)，請按下 **START/MEMORY** 開始接收。



- 3 如果對方要與您先進行通話後再傳送傳真，請在通話後按下 **START/MEMORY**。(請在傳送方按下他們的開始鍵之前先按下該鍵)。



RECEIVING
(正在接收)

- 在顯示屏上出現 RECEIVING (正在接收) 信息時，請掛上聽筒。



使用電話分機接聽

- 1 在電話分機響鈴時接聽。



- 2 如果您聽到柔和的傳真信號，請等待傳真機作出回應 (分機將無回應)，然後再掛上聽筒。



電話無回應



3 如果傳真機無回應，或者對方要先與您通話後才傳送傳真，請按分機 **5**

一下，再按 ***** 兩下 (僅適用於按鍵式電話)。這將通知傳真機開始接收傳真。接著再掛上聽筒。

- 如果您已將傳真信號接收設定值 (請參閱以下內容) 設定為 NO (否)，則必須執行以上步驟。
- 如果傳真機的送紙器中已裝入文件，傳真機將不接受開始接收的信號 (**5****)。

保留通話

要保留與對方的通話線路，請按 **▶PLAY/HOLD** 。執行此步驟後，對方就無法聽到您的聲音。您可將聽筒掛回，而不會中斷連接。準備與對方再次通話時，拿起聽筒。如果您沒有將聽筒掛回，請再次按 **▶PLAY/HOLD**  恢復通話。

可選用的接收設定

接收傳真信號

如果您在透過傳真機或電話分機接聽來電後聽到柔和的傳真信號，傳真機將自動開始接收。如果您在同一條線路上使用電腦傳真解調器傳送文件，則您必須先關閉此功能，以防止傳真機錯誤地嘗試從電腦傳真解調器接收文件。請執行以下步驟以變更設定值。

1 依次序按 **FUNCTION**  與 **▲** 一下。

顯示屏顯示：

OPTION SETTING 
(選項設定)



2 按 **▶** 一下後再按 **▼** 六下。

FAX SIGNAL RX 
(接收傳真信號)

3 按  一下。

1=YES, 2=NO

(1=是, 2=否)

4 按  啟用此功能，或按  將其關閉。

顯示屏上將會簡略地顯示您的選擇，然後顯示：

CALLER-ID

(來電顯示)

5 按  返回日期和時間顯示。

變更遙距啟動傳真的號碼

如有需要，您可設定 5 以外的數字，作為從電話分機啟動傳真接收功能的號碼。您可選擇從 0 至 9 的任何數字。

1 依次序按  與  一下。

顯示屏顯示：

OPTION SETTING

(選項設定)

2 依次序按  與  一下。

FAX REMOTE #

(遙距傳真代碼)

3 按  一下。

ENTER (0-9) (5)

(輸入 [0-9] [5])

4 輸入所要的數字 (從 0 至 9 的任何數字)。

顯示屏上將會簡略地顯示您的選擇，然後顯示：

範例：3 

TRANSACTION

(執行報告)

5 按  返回日期和時間顯示。

接收比例



傳真機在出廠時已設定為自動縮小接收文件尺寸，使能符合打印紙的尺寸。這樣便可確保不會截斷文件邊緣上的資料。如有需要，您可關閉此功能，並以實際大小打印收到的文件。

- ◆ 如果文件因太長而不符合打印紙大小，則剩餘部份將繼續印在第二頁上。在這種情況下，截斷點可能會出現在一行的中間位置。
- ◆ 如果收到的文件太大並包含過多的細緻圖形或圖像，或以高解像度傳送，則自動縮小功能就可能無效。在這種情況下，文件的剩餘部份將繼續打印在第二頁上。

1 依次序按  與  一下。

顯示屏顯示：

OPTION SETTING 
(選項設定)

2 按  一下，再按  三下。

RECEIVE RATIO 
(接收比例)

3 按  一下。

1=AUTO, 2=100%
(1=自動，2=100%)

4 按  選擇 AUTO (自動)，或按 
選擇 100%。

顯示屏上將會簡略地顯示您的選擇，然後顯示：

PRINT CONTRAST 
(打印對比度)

5 按  返回日期和時間顯示。

替代接收至記憶體

在無法打印的情況下 (例如傳真機缺紙、需要更換膠卷或夾紙，傳送進來的傳真將會接收至記憶體中。

在您將文件接收至記憶體時，顯示屏上將會出現 FAX RX IN MEMORY (傳真接收至記憶體) 信息，並交替出現 ADD PAPER & PRESS START KEY (添加紙張並按下 START [開始] 鍵) 或 CHECK FILM/CHECK COVER/CHECK PAPER JAM (檢查膠卷/檢查槽蓋/檢查夾紙) 信息。在您添加紙張 (並按下 **START/MEMORY** )、更換膠卷或清除夾紙後，儲存的文件便會自動打印。

即使拔下電源線或發生電力故障，傳真機仍會把接收的傳真保留在記憶體內，直到列印出來為止。

5. 複印

本傳真機也可用來複印文件。您可使用傳真機複印一份或多份文件 (每份原稿最多可複印 99 份)，這樣您的傳真機就兼具辦公用複印機的功能了。

1 將文件正面朝下放入。(最多 10 頁。)

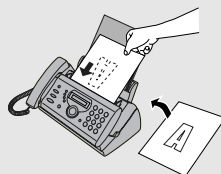

- 如有必要，按 **RESOLUTION**  設定解像度與/或對比度。
(複印的解像度預設值為 FINE [細緻])。



READY TO SEND

(傳送就緒)

2 如有需要，請選擇放大/縮小設定值，並/或選擇每份原稿的複印份數：

- 放大/縮小：按  或  直到所需的設定顯示在顯示屏上。可選擇的設定值包括：100%、125%、135%、50%、73%、88%、94% 及 AUTO (自動)。(預設值為 100%。)

範例：按  兩下 → RATIO: 125%
(比例：125%)

- 每份原稿的複印數量：按數字鍵輸入 1 至 99 之間的數字。(預設值為 1。)

範例：按  複印五份文件 → 5

3 在您準備開始複印時，請按下 **COPY/POLL** 。

如果顯示屏上出現 MEMORY IS FULL (記憶體已滿)...信息

如果在掃描文件時記憶體已滿，顯示屏上將會交替出現 MEMORY IS FULL (記憶體已滿) 與 SEE MANUAL (請參閱操作手冊) 信息，且文件會自動退出。如果您將解像度設定為 SUPER FINE (超細緻)、選擇了某個放大/縮小設定值，或要將每份原稿複印多份副本，則可能會出現此情況。為免佔用過多記憶體，請將解像度設定為 STANDARD (標準) 或 FINE (細緻)，將放大/縮小比例設定為 100%，並且每份原稿僅複印一份副本。

Copy Cut-off (中斷複印)

在複印長度超過打印紙的文件時，您可使用 Copy Cut-off (中斷複印) 設定值來選擇是否截斷文件的剩餘部份，或在第二頁上繼續打印。起始設定值為 YES (是)，即截斷剩餘部份。要變更此設定值，請執行以下步驟。

- 1** 依次序按  與  一下。

顯示屏顯示：

OPTION SETTING 

(選項設定)

- 2** 依次序按  與  一下。

COPY CUT-OFF 

(中斷複印)

- 3** 按  一下。

1=YES, 2=NO

(1=是，2=否)

- 4** 按 **1** 將 Copy Cut-off (中斷複印) 設定為 YES (是，文件的剩餘部份將不會打印)，或按 **2** 將中斷複印設定為 NO (否，剩餘部份將印在第二頁)。

顯示屏上將會簡略地顯示您的選擇，然後顯示：

NUMBER OF RING 

(響鈴次數)

- 5** 按  返回日期和時間顯示。

6. 特殊功能

來電顯示 (需要另行申請的服務)

如果您向電訊公司申請來電顯示服務，則您可設定傳真機在響鈴時顯示來電者姓名與號碼。

重要事項：

- ◆ 要使用此功能，您必須向電訊公司申請來電顯示服務。
- ◆ 您的傳真機可能無法與某些來電顯示服務配合使用。

1 依次序按  與  一下。

顯示屏顯示：



OPTION SETTING 
(選項設定)

2 按  一下後再按  五下。

CALLER-ID 
(來電顯示)

3 按  一下。

1=YES, 2=NO
(1=是, 2=否)

4 按  (YES) 啟用「來電顯示」。
(要關閉來電顯示功能，請按 )

顯示屏上將會簡略地顯示您的選擇，然後顯示：

ECM MODE 
(ECM 模式)

5 按  返回日期和時間顯示。

來電顯示功能的操作方式

接聽來電時，在第二聲響鈴前，顯示屏上將開始交替出現來電者姓名與電話號碼。此資訊會一直顯示，直到線路中斷為止。

註：某些來電顯示服務可能不提供來電者姓名。在這種情況下，顯示屏上僅會出現電話號碼。

顯示範例

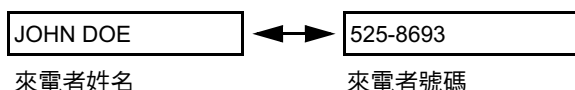

顯示屏信息

如果傳真機在響鈴時沒有顯示來電者資訊，則顯示屏上將出現以下某則信息：

- | | |
|-------------------------------------|---|
| NO SERVICE
(未提供服務) | 沒有收到電訊公司的來電者資訊。請確定電訊公司已啟動您的服務。 |
| CALLER-ID ERROR
(來電顯示錯誤) | 電話線路雜訊使來電者資訊無法接收。 |
| OUT OF AREA
(服務區域之外) | 來電區域未提供來電識別服務，或來電識別服務無法與您當地電訊公司的服務配合使用。 |
| PRIVATE CALL
(私人來電) | 電訊公司應來電者要求不提供資訊。 |

檢視來電顯示清單

如果您申請了來電顯示服務，並已啟用此項功能，則傳真機將會保存您最近接收的 30 個來電與傳真資訊。您可在來電顯示清單中檢視這些資訊 (包含每位來電者的姓名與號碼)。

- ◆ 在您接收了 30 個來電後，新的來電將會逐一刪除最早接收的來電號碼。
- ◆ 如果您拔下傳真機的電源線或電源發生故障，所有來電資料將被清除。

來電顯示 (需要另行申請的服務)

請執行下列步驟以在顯示屏上檢視來電顯示清單。如有需要，您可立即撥打顯示屏上出現的號碼。

1 按  兩下。



<REVIEW CALLS> 
(< 檢視來電 >)

2 按  或  捲動瀏覽整個清單。

3 如果您要撥打清單中的某個號碼，請捲動清單直到顯示屏上出現該號碼。

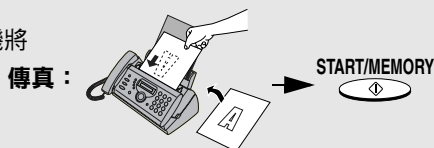
- **傳真**：如果您要傳送傳真，請放入文件，然後按下 。傳真機將會開始撥號與傳送。



- **語音電話**：如果您要撥打語音電話，請拿起聽筒 (或按下 )。傳真機將會自動開始撥號 (如已按下 ，請在對方接聽時拿起聽筒。)



4 完成檢視清單後，請按 。

刪除來電顯示清單中的來電

如果您要刪除來電清單中的某個來電，請於顯示屏出現該電話時按下 。
DELETE

如果您要刪除清單中的所有來電，請在檢視清單中的任何號碼時，按住

 3 秒以上。



DELETE

優先來電



在開啟來電顯示功能後，您可設定傳真機在接收特定電話號碼的來電時發出特殊的鈴聲。這樣一來，您無需查看顯示屏即可知道來電者身份。

要使用此功能，請按照以下步驟輸入所要的電話號碼 (一次僅可輸入一個電話號碼)。

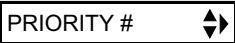
1 按  一下，再按  兩下。顯示屏顯示：
(輸入模式)

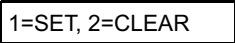
2 依次序按  與  一下。
(優先號碼)

3 按  一下。
(1=設定，2=清除)

4 按  儲存號碼。
(要清除之前儲存的號碼，請按  並跳至步驟 6。)

5 按數字鍵輸入傳真號碼 (最多 20 位數)。

6 按  儲存 (或清除) 號碼。
(設定本機號碼)

7 按  返回日期和時間顯示。

來電顯示 (需要另行申請的服務)

停止語音來電

在啟用來電顯示功能後，您可使用本章 *停止接收不要的傳真* 中所述的「過濾垃圾傳真」功能，以停止接收來自特定垃圾號碼的語音來電與傳真。

在這種情況下，如果接收的語音來電或傳真號碼，已被指定為「垃圾號碼」，則已啟用來電顯示功能的傳真機，將會在第二聲響鈴之前立即中斷連接。

要使用此功能，請按照 *停止接收不要的傳真* 中的說明，輸入要停止的號碼 (請參閱第 74 頁)。您僅可設定一個停止接收號碼。

雙音辨號 (需要另行申請的服務)

如果您是使用由電訊盈科 (PCCW) 提供的 Homefax 2 或 3，或是 Faxline 2 或 3 的服務，則您必須開啟雙音辨號功能。在開啟雙音辨號功能後，傳真機會在接獲語音來電時發出較短的鈴聲，而在接獲傳真來電時發出較長的鈴聲。

- ◆ 要獲得有關 Homefax 服務的更多資訊，請撥 1000 與 PCCW 聯絡。
- ◆ **雙音辨號僅在接收模式設定為 FAX (傳真) 或 TEL/FAX (電話/傳真) 模式時才有效。**當有傳真傳送過來時，傳真機將在 NUMBER OF RINGS (響鈴次數) 設定中所設定的響鈴次數之後自動接收來電 (請參閱第 59 頁)。您必須拿起聽筒才能接聽語音來電。

重要須知：

僅有 Homefax 2、3 與 Faxline 2、3 的用戶才可使用雙音辨號功能。請勿在您使用正常線路時開啟雙重響鈴功能，否則傳真機將無法正常操作。

請按照以下步驟開啟雙音辨號功能。

1 依次序按  與  一下。

顯示屏顯示：



OPTION SETTING 
(選項設定)

2 按  一下後再按  五下。

DUPLEX RINGING 
(雙音辨號)

3 按  一下。

1=YES, 2=NO
(1=是, 2=否)

4 按  啟用此功能，或按  將之關閉。



顯示屏上將會簡略地顯示您的選擇，然後顯示：

FAX SIGNAL RX 
(傳真信號接收)

5 按  返回日期和時間顯示。



停止接收不要的傳真

過濾垃圾傳真功能容許您停止接收來自您所指定的傳送方之傳真。由於不用打印不想要的「垃圾」傳真，因此可以節省紙張。要使用此功能，請執行以下步驟輸入您不想接收其傳真的傳真號碼。您僅可輸入一個傳真號碼。

1 按  一下，再按  兩下。

顯示屏顯示：

ENTRY MODE 
(輸入模式)

2 按  一下，再按  兩下。

ANTI JUNK # 
(限制接收號碼)

3 按  一下。

1=SET, 2=CLEAR
(1=設定，2=清除)

4 按  儲存限制接收號碼，或按  清除之前儲存的號碼 (如果是要清除號碼，請跳至步驟 6)。

5 按數字鍵輸入傳真號碼 (最多20 位數)。



6 按 ，再按  返回日期和時間顯示。

自動回傳 (請求傳送傳真)

自動回傳功能讓您可撥打其他傳真機號碼，令其傳送文件 (已事先放入其送紙器中) 至您的傳真機，而不需要對方傳真機的操作者協助。

- ◆ **提示：**自動回傳對於您希望由接收方傳真機，而不是由傳送方傳真機承擔撥號成本時相當有用。

1 使用下列其中一個方法來撥打您要其自動回傳的傳真機號碼：

- 使用數字鍵來輸入完整的號碼。
- 拿起聽筒 (或按 ) 撥打完整的號碼。等待傳真機的回應信號。
- 如果該號碼已經儲存為自動撥號號碼，請按  或  直到對方姓名 (或號碼) 出現在顯示屏上。

2 按 。

- 如果您使用的是聽筒，請在顯示屏上出現 POLLING (自動回傳) 時掛上聽筒。開始接收。

7. 打印清單

您可以打印傳真機的設定值與資訊清單，這些清單的相關說明如下。要打印清單，請執行下列步驟。

1 依次序按  與  兩下。

顯示屏顯示：

LISTING MODE 
(清單模式)

2 按  一下。

TEL # LIST 
(電話號碼清單)

3 按  或  直到顯示屏上出現所要的清單。

4 按  一下。

PRESS START KEY
(按開始鍵)

5 按  打印清單。

電話號碼清單

此清單顯示已儲存的自動撥號傳真和電話號碼。

設定清單

此清單顯示目前選擇的 **FUNCTION (功能)** 鍵設定值。此外，還顯示輸入傳真機中的姓名與傳真/電話號碼，以及打印在每張傳真頁面頂端的標題樣式 (**HEADER PRINT [打印標題]**)。

SETUP LIST		12-NOV-2004 13:14
FOR:		
O.M. SETTING		
TOLL SAVER	YES	
RECORDING TIME	4 MIN.	
REMOTE CODE NO.	001	
OVERRIDE CODE NO.	000	
TRANSFER TELEPHONE NO.		
TRANSFER TELEPHONE CALLING	NO	
ON S.P. FAILURE	NO	
(UNIT SETS TO AUTO FAX RCV.)		
OGM ONLY MODE	NO	
ENTRY MODE		
ANTI JUNK NUMBER		
PRIORITY CALL NO.		
SENDER'S NAME		
SENDER'S TELEPHONE NUMBER		
HEADER PRINT		P.01
12-NOV-2004 13:15		
OPTION SETTING		
NUMBER OF RINGS IN AUTO ANSWER MODE	2 RINGS	
TEL/FAX REMOTE NO.	CS***	
TRANSACTION PRINT SELECT	ERROR ONLY	
DIAL MODE	1TONE	
PSEUDO RINGING DURATION	15S	
DUPLEX RINGING	NO	
FAX SIGNAL RECEIVE	YES	
CALLER-ID	NO	
ECH MODE	YES	
RECEPTION RATIO	AUTO	
PRINT CONTRAST	NORMAL	
COPY CUT OFF	YES	

信息清單

此清單顯示有關留言機內目前已錄製的信息資訊，包括每則信息的錄製日期與時間、長度及類型。

來電顯示清單

此清單顯示最近 30 個來電的相關資訊。(此清單只有在啟用「來電顯示」功能時才可使用。)

執行報告

傳真機在操作完成後會自動打印報告，以供您核對結果。傳真機的原廠設定為，只有在發生錯誤時才會打印此報告。

- ◆ 您無法隨時打印執行報告。

執行報告標題

**SENDER/
RECEIVER**
(傳送方 /
接收方)

傳真時對方傳真機的姓名或傳真號碼。如果該傳真機不具有來電顯示功能，則顯示屏上將會出現通訊模式 (例如：「G3」)。

START
(開始時間)

開始傳送/接收的時間。

TX/RX TIME
(傳送 / 接收時間)

傳送/接收所需的總時間。

PAGES
(頁數)

傳送/接收的頁數。

NOTE
(附註)

(報告的 **NOTE [附註]** 欄將會出現以下的任一則註解，說明該項操作是否成功執行；如未能成功執行，則指出失敗原因。)

OK — 傳送/接收成功。

P.FAIL — 因電源故障而無法執行。

JAM — 因打印紙或文件夾紙而無法執行。

BUSY — 因線路繁忙而未能傳送傳真。

COM.E-X — (其中「X」為一號碼。) 因電話線路錯誤而無法執行。請參閱線路錯誤 (第 83 頁)。

CANCEL — 因按下 **STOP (停止)** 鍵、送紙器內無文件、或傳真機不具有對方傳真機所要求的傳送功能而取消作業。如要傳送傳真，請確定文件已放入送紙器內。如要接收傳真，請聯絡傳送方，以瞭解對方嘗試傳送傳真的方式。

執行報告的打印條件

您可變更打印執行報告的條件。請執行以下步驟。

- 1** 依次序按  與  一下。

顯示屏顯示：

OPTION SETTING 
(選項設定)

- 2** 按  一下，再按  兩下。

TRANSACTION 
(執行報告)

- 3** 按  一下。

1:ALWAYS PRINT
(1：隨時打印)
(選項會交替出現)

- 4** 按  至  之間的數字，選擇打印條件。

- | | | |
|---|---------------------------------|---------------------|
|  | ALWAYS PRINT
(隨時打印) | 在每次傳送、接收或出現錯誤後打印報告。 |
|  | ERROR/MEMORY
(錯誤/記憶體) | 在出現錯誤或執行記憶體相關操作後打印。 |
|  | SEND ONLY
(僅在傳送後) | 在每次傳送後打印報告。 |
|  | ERROR ONLY
(僅在發生錯誤後) | 僅在發生錯誤後打印報告。 |
|  | NEVER PRINT
(不打印) | 不打印報告表。 |

顯示屏上將會簡略地顯示您的選擇，然後顯示：

DIAL MODE 
(撥號模式)

- 5** 按  返回日期和時間顯示。

8. 維護

印字頭

經常清潔印字頭可確保獲得最佳的打印效果。

註：在清潔印字頭之前，請先取出供紙托架內的紙張。

- 1** 拔出電話線，然後拔掉電源線並打開操作面板 (按 ❶)。

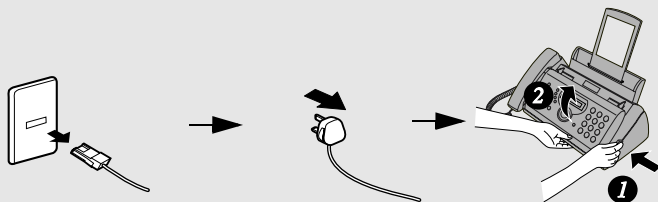

- 2** 從打印槽中取出膠卷，並將其放在一張紙上。

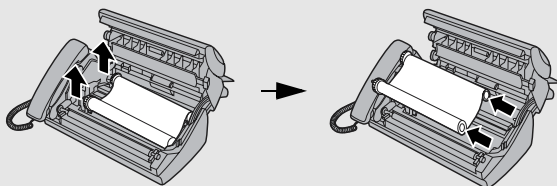

- 3** 用異丙醇或工業用酒精擦拭印字頭。

注意！

- 切勿使用苯或稀釋劑。避免以硬物觸碰印字頭。
- 如果傳真機剛接收了大批文件，則印字頭可能會發燙。在此情況下，請先讓印字頭冷卻，然後再進行清潔。

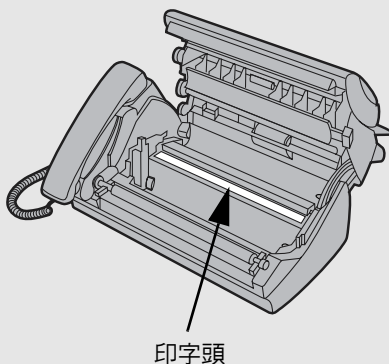

4 將膠卷裝回打印槽內。

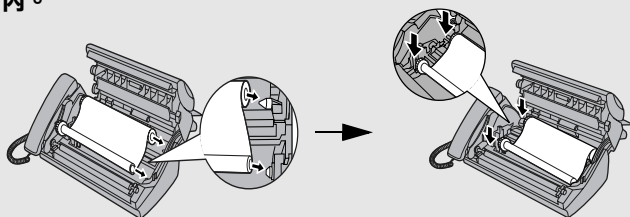

5 轉動前端齒輪直到膠卷拉緊，然後關上操作面板 (按下兩側，確定其已卡入定位)。

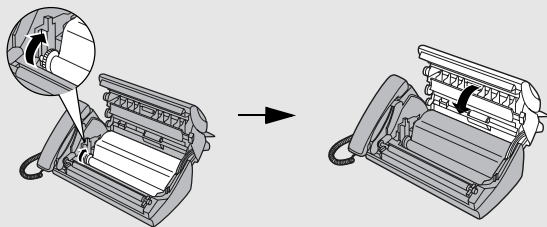

掃描鏡與滾軸

經常清潔掃描鏡和滾軸，可確保圖像和複印品質。

註：取出供紙托架內的紙張後再清潔掃描鏡和滾軸。

1 打開操作面板 (按 ❶)。



2 往上扳開白色滾軸兩側的綠色桿。

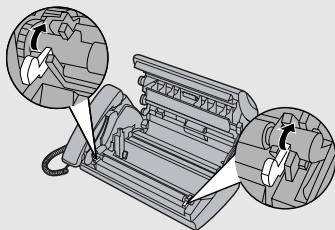

3 使用棉花棒擦拭掃描器鏡 (在白色滾軸下方) 和滾軸。

- 確定已清除所有的灰塵與污垢 (例如塗改液)。灰塵與污垢會在傳真圖像與複印本上產生垂直線條。

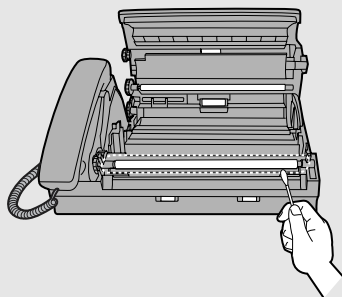

如果掃描鏡難以清潔乾淨

如掃描鏡上的灰塵難以清除，可嘗試使用異丙醇或工業用酒精沾濕棉花棒，然後再行清潔掃描鏡。請勿讓滾軸沾到酒精。

4 往下壓回白色滾軸兩側的綠色桿。轉動前端齒輪直到膠卷拉緊，然後關上操作面板 (按下兩側，確定其已卡入定位)。

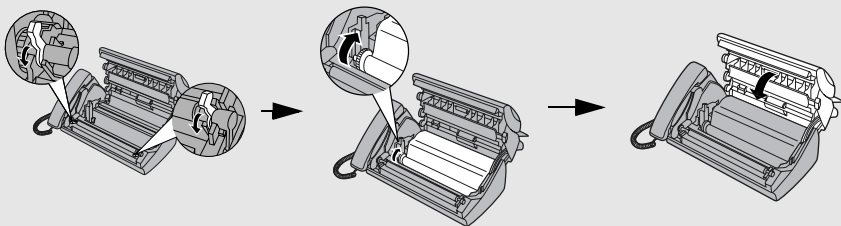

機殼

請用乾布擦拭傳真機的外部零件和表面。

注意！

切勿使用苯或稀釋劑，這些溶劑可能會使傳真機受損或褪色。

9. 故障排除

問題與解決方法

線路錯誤

問題	解決方法
顯示屏出現 LINE ERROR (線路錯誤)。	<p data-bbox="421 443 956 501">請嘗試重新執行操作。如果錯誤仍然存在，請檢查以下事項：</p> <ul data-bbox="421 539 983 900" style="list-style-type: none"><li data-bbox="421 539 983 596">• 檢查線路。從 TEL. LINE (電話線路) 插孔到牆壁插座的連接線不應超過兩公尺。<li data-bbox="421 628 969 654">• 確定沒有與其他解調器裝置共用同一條電話線路。<li data-bbox="421 686 848 711">• 與對方確認，確定其傳真機操作正常。<li data-bbox="421 743 725 769">• 檢查電話線路是否有雜訊。<li data-bbox="421 801 824 826">• 嘗試將傳真機連接至另一條話線路。<li data-bbox="421 858 969 884">• 如果問題仍然存在，則您的傳真機可能需要維修。

撥號與傳送問題

問題	解決方法
<p>拿起聽筒或按下  鍵時聽不到撥號音。</p>	<ul style="list-style-type: none"> • 確定聽筒連接線已連接至正確的插孔。請參閱 <i>連接聽筒</i> (第 10 頁)。
<p>無法撥號。</p>	<ul style="list-style-type: none"> • 確定電源線已正確插入電源插座。 • 確定電話線已正確地連接到 TEL. LINE (電話線路) 插孔與牆壁上的插座。 • 確定已將傳真機設定為適用於電話線路的正確撥號模式。請參閱 <i>撥號模式</i> (第 11 頁)。
<p>電源已開，但無法傳送。</p>	<ul style="list-style-type: none"> • 確定接收方傳真機上有紙張。 • 確定電話線已插入 TEL. LINE (電話線路) 插孔，而非 TEL. SET (電話機) 插孔。 • 如果接收方傳真機處於手動模式且無人操作，則將無法接收。 • 查看顯示屏上是否有錯誤信息。 • 拿起聽筒並檢查有否撥號音。
<p>接收方沒有打印出任何東西。</p>	<ul style="list-style-type: none"> • 確定要傳送的文件是正面朝下放在送紙器中。
<p>對方收到的圖像失真。</p>	<ul style="list-style-type: none"> • 電話線路上的雜訊可能會導致圖像失真。請嘗試重新傳送文件。 • 使用傳真機複印該文件。如果副本也失真，則您的傳真機可能需要維修。

接收與複印問題

問題	解決方法
電源已開啟，但無法接收。	<ul style="list-style-type: none"> 確定電話線已插入 TEL. LINE (電話線路) 插孔，而非 TEL. SET (電話機) 插孔。
嘗試接收文件時打印空白頁。	<ul style="list-style-type: none"> 確定該文件已正確放入傳送方傳真機的送紙器。複印一頁文件或打印一份記錄來確定傳真機的打印功能是否正常。
一般打印品質欠佳。	<ul style="list-style-type: none"> 請務必選用適合傳真機感熱式打印功能的紙張。建議您使用表面較為光滑的鐳射品質紙張。複印紙也可使用，但打印品質有時會較差。
收到的文件頁面模糊。	<ul style="list-style-type: none"> 要求對方以較高的對比度傳送文件。如果收到的文件之對比度仍然過低，則您的傳真機可能需要維修。複印一頁文件或打印一份記錄來確定傳真機的打印功能是否正常。
收到的圖像失真。	<ul style="list-style-type: none"> 電話線路上的雜訊可能會導致圖像失真。請對方嘗試重新傳送文件。 印字頭可能髒了。請參閱第 80 頁的<i>印字頭</i>。 使用傳真機複印一頁文件或打印一份報告。如果複印本或報告仍然失真，則您的傳真機可能需要維修。
收到的文件或打印出來的文件上有條紋。	<ul style="list-style-type: none"> 確定操作面板已完全關上 (壓下面板兩側)。
複印品質欠佳且/或出現黑色垂直線。	<ul style="list-style-type: none"> 掃描鏡上的任何污漬或異物都會造成複印本和傳真文件出現黑線。請按第 81 頁的說明清潔掃描鏡。
接收/複印中斷。	<ul style="list-style-type: none"> 如果接收/複印持續很長一段時間，印字頭可能會過熱。關閉電源讓其冷卻。如果經常發生過熱現象，請試著將打印對比度改為 LIGHT (淡) (請參閱第 17 頁)。
複印本或收到的傳真上出現黑色的垂直線條。	<ul style="list-style-type: none"> 嘗試將打印對比度設定變更為 LIGHT (淡) (請參閱第 17 頁)。

一般問題

問題	解決方法
使用喇叭時出現吵雜的噪音。	<ul style="list-style-type: none">• 如果您在喇叭開啟時掛上聽筒，則可能會出現回音 (吵雜噪音)。要避免回音，請在關閉喇叭 (按  鍵) 後再掛上聽筒。
傳真機無法儲存自動撥號號碼。	<ul style="list-style-type: none">• 確定電源插頭已插入傳真機內並已裝入膠卷。(如未裝入膠卷，自動撥號號碼即無法儲存。) 請參閱第 14 頁的裝入膠卷。
顯示屏沒有出現任何信息。	<ul style="list-style-type: none">• 確定電源線已正確插入電源插座。• 將其他電器裝置連接至該電源插座，以查看插座有否供電。
在您按下任何按鍵後，傳真機沒有反應。	<ul style="list-style-type: none">• 按下按鍵時傳真機沒有發出嗶聲，請拔掉電源線，在數秒後再重新接回電源線。
傳送或複印時無法自動送紙。	<ul style="list-style-type: none">• 檢查文件的尺寸與重量 (請參閱第 43 頁的可傳送的文件)。

信息與信號

顯示屏信息

註：如果未啟用來電顯示功能，請參閱第 69 頁與來電顯示相關的顯示屏信息。

<p>ADD PAPER & / PRESS START KEY (添加紙張並/按下開始鍵) (交替出現信息)</p>	<p>檢查打印紙。如果供紙托架是空的，請添加紙張，然後按下 START/MEMORY (開始/記憶) 鍵。如果供紙托架中有紙張，請確保紙張已正確放入 (取出紙疊，將其邊緣對齊，再重新放入托架中)，再按下 START/MEMORY (開始/記憶) 鍵。</p>
<p>A.M. TRANSFER (留言機轉接)</p>	<p>留言機的轉接功能已開啟 (請參閱第 32 頁)。</p>
<p>CHECK FILM/ CHECK COVER/ CHECK PAPER JAM (檢查膠卷膠卷/檢查槽蓋/ 檢查夾紙) (交替出現信息)</p>	<p>打印槽發生故障而無法進行打印時，顯示屏上即會交替出現這些信息。查看膠卷是否安裝正確或已經用完，需要更換。確定操作面板已完全關上 (壓下兩側)。如果發生夾紙，請依後述章節 <i>清除夾紙</i> 中的說明，清除夾紙。</p>
<p>CHECK PAPER SIZE (檢查紙張尺寸)</p>	<p>供紙托架中放入的紙張大小不正確。請取出紙張，裝入 A4 大小的紙張。</p>
<p>DOCUMENT JAMMED (文件夾紙)</p>	<p>文件原稿發生夾紙狀況。請參閱下節的 <i>清除夾紙</i>。如果一次放入的文件超過 10 頁或放入的文件過厚，均會發生文件夾紙的情況 (請參閱第 43 頁)。</p>
<p>FAX RX IN MEMORY (傳真接收至記憶體)</p>	<p>由於需要更換膠卷、打印紙用完或夾紙，因此已接收的傳真儲存在記憶體中。解決這些問題後，傳真將會自動打印。</p>
<p>FUNCTION MODE (功能模式)</p>	<p>已按下 FUNCTION (功能) 鍵。</p>
<p>LINE ERROR (線路錯誤)</p>	<p>傳送或接收失敗。請按下 STOP (停止) 鍵清除此信息，然後重試。如果錯誤依舊存在，請參閱 <i>線路錯誤</i> (第 83 頁)。</p>

<p>MEMORY IS FULL/ SEE MANUAL (記憶體已滿/請參閱操作手冊) (交替出現信息)</p>	<p>記憶體已滿。這表示留言機已接收過多信息。要清除信息，請參閱第 29 頁。 如果已接收的資料過多而傳真機又無法及時將其打印，則可能會出現此信息。如因無法打印 (將有附加信息指出問題所在) 而傳真接收至記憶體，請解決此問題以便能繼續打印 (請參閱第 65 頁的<i>替代儲存接收</i>)。如果您嘗試透過記憶體傳送，請參閱第 56 頁的<i>如果記憶體已滿</i>。如果您正在複印，請參閱第 66 頁的<i>如果出現 MEMORY IS FULL (記憶體已滿) 的信息</i>。</p>
<p>MEMORY PRINTING (儲存打印)</p>	<p>傳真機正準備或正透過記憶體打印文件。</p>
<p>NO DATA (無資料)</p>	<p>如果您尚未儲存任何自動撥號號碼，卻嘗試搜尋這些號碼時，即會出現此信息。</p>
<p>OFF HOOK (聽筒未掛上)</p>	<p>使用聽筒撥號及傳送傳真後忘記掛上聽筒，即會出現此信息。請掛上聽筒，或按 STOP (停止) 鍵清除此信息。</p>
<p>ON HOOK DIAL (免提撥號)</p>	<p>已按下  鍵，傳真機正等待您撥號。</p>
<p>OVER HEAT (過熱)</p>	<p>印字頭過熱。冷卻後即可繼續操作。如果經常發生過熱現象，請試著將打印對比度改為 LIGHT (淡) (請參閱第 17 頁)。</p>
<p>PRINT HEAD FAIL/ YOU NEED SERVICE (印字頭故障/需要維修) (交替出現信息)</p>	<p>印字頭發生故障，需要維修。</p>
<p>READY TO SEND (傳送就緒)</p>	<p>已放入文件，傳真機正等待您開始傳真或複印。</p>
<p>RECALLING (正在重撥)</p>	<p>如果您嘗試使用自動撥號傳送傳真，但遇上線路繁忙或接收方傳真機未接聽時，即會出現此信息。傳真機將自動重新嘗試撥號。(請參閱第 53 頁的<i>自動重撥</i>)</p>

TOTAL MSGS:XX (總信息數：XX)	這表示您的留言機已收到信息。XX 為信息數目。
TOTAL PAGE(S) 01 (總頁數 01)	已經傳送、接收或複印的頁數。

聲頻信號

連續音頻	3 秒	表示傳送、接收或複印結束。
間歇音頻 (嗶 3 聲)	5 秒 (響 1 秒，停 1 秒)	表示傳送、接收或複印未完成。
短促的間歇音頻	35 秒 (響 0.7 秒，停 0.3 秒)	表示聽筒未掛上。

清除夾紙

清除文件夾紙

如果文件原稿在傳真或複印時未正確送入傳真機，或顯示屏顯示 DOCUMENT JAMMED (文件夾紙) 時，請先按 **START/MEMORY** 。如果文件無法退出，請按照以下所述取出文件。

重要事項：

如未按照以下所述鬆開被夾住的文件，請勿嘗試將其取出，否則可能會損毀送紙器機件。

- 1** 按 **1**，然後慢慢打開操作面板，直到操作面板已打開一半。

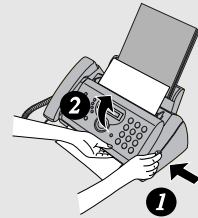

- 2** 往上扳開白色滾軸兩側的綠色桿。

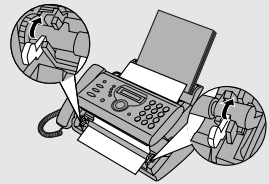

- 3** 輕輕取出文件。

- 小心不要撕破文件。

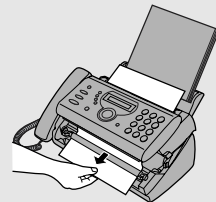

- 4** 往下壓回白色滾軸兩側的綠色桿。轉動前端齒輪直到膠卷拉緊，然後關上操作面板 (按下兩側，確定其已卡入定位)。

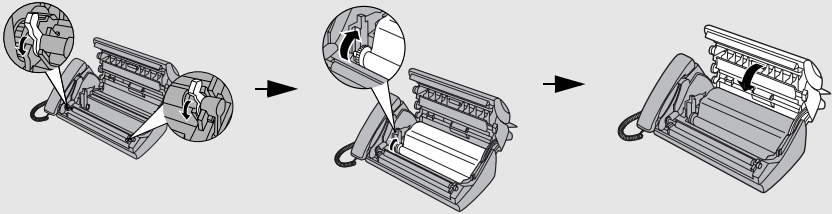

清除被夾住的打印紙

- 1** 打開操作面板 (按 ❶)。

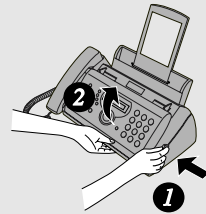

- 2** 輕輕將夾紙拉出傳真機，並確定打印槽內或滾軸上未有殘留紙屑。

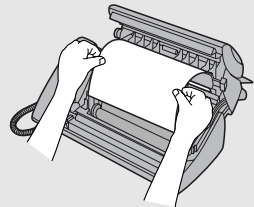

- 3** 轉動前端齒輪直到膠卷拉緊，然後關上操作面板 (按下兩側，確定其已卡入定位)。

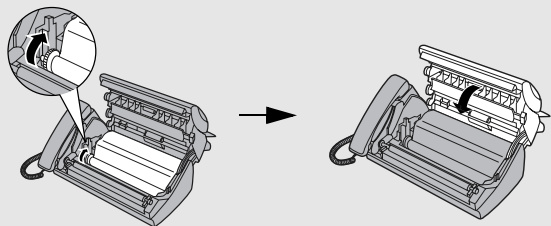



快速參考指南

傳送傳真

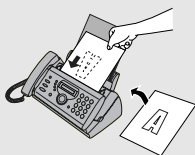
將文件 (最多 10 頁)
正面朝下放入文件送
紙器。



一般撥號

1. 拿起聽筒或按 。
2. 撥打傳真號碼。
3. 等待接收音頻 (如果有人接聽, 請對方按下其傳真機上的「開始」鍵)。
4. 按 。





自動撥號

1. 按  或  直到顯示屏上出現對方姓名。
2. 按 。

直接按鍵撥號

1. 撥打傳真號碼。
2. 按 。

錄製外出留言信息

1. 按 、 與 。
2. 拿起聽筒, 按  並對著聽筒講話。
3. 完成後請按 。

接收傳真

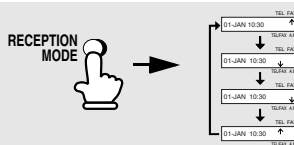

FAX (傳真) 模式：傳真機會自動接聽與接收傳真。

TEL (電話) 模式：須拿起聽筒來接聽所有來電 (包括傳真)。要開始接收傳真, 請按 。

TEL/FAX (電話/傳真) 模式：傳真機會自動接聽與接收傳真。傳真機會發出特殊鈴聲以表示此為語音來電。

A.M. (留言機) 模式：在您外出時請選擇此模式以接收留言與傳真。

儲存自動撥號號碼

1. 按  一下, 再按  兩下。
2. 輸入完整的傳真/電話號碼。
3. 按 。
4. 按數字鍵輸入姓名。(如要輸入的連續兩個英文字母均需要使用同一按鍵, 請在輸入首個字母後按 。)

SPACE = 1	G = 4	N = 6 6	U = 9 9
A = 2	H = 4 4	O = 6 6 6	V = 9 9 8
B = 2 2	I = 4 1 1	P = 7	W = 9
C = 2 2 2	J = 5	Q = 7 7	X = 9 9
D = 3	K = 5 5	R = 7 7 7	Y = 9 9 9
E = 3 3	L = 5 5 5	S = 7 7 7 7	Z = 9 9 9 9
F = 3 3 3	M = 6	T = 8	

5. 按  後按 。

索引

A

Anti Junk Fax, 74

D

Duplex Ringing, 73

E

ECM (誤差修正模式), 54

P

Polling, 75

T

TEL. LINE (電話線) 插孔, 11

TEL. SET (電話機) 插孔, 13

Toll Saver (節費功能), 37

一劃

一般撥號, 47

四劃

分機

使用, 61

文件, 最大掃描尺寸, 43

文件尺寸, 43

文件限制, 44

日期, 設定, 20

五劃

外出留言信息, 25

六劃

印字頭, 清潔, 80-81

自動撥號號碼

使用, 51

儲存, 48

七劃

夾紙, 清除, 90-91

八劃

供紙托架延伸板, 12

來電顯示, 68-72

來電顯示清單, 77

放入文件, 44

放入紙張, 16

直接按鍵撥號, 52

九劃

信息

清除, 29

聆聽, 28

設定時間長度, 30

遙距聆聽, 38

信息清單, 77

保留, 62

英文字母, 輸入, 19, 49

重撥, 53

十劃

時間, 設定, 20

留言機出現故障時接收傳真, 30

留言機接收模式, 22, 26, 58

留言機模式的響鈴次數, 27

紙張, 放入, 16

記憶體傳送, 56

送紙器, 44

十一劃

執行報告, 78

設定打印條件, 79

接收傳真訊號, 62

接收模式

留言機模式, 22, 26, 58

傳真模式, 22, 59

電話/傳真模式, 22, 57

電話模式, 22, 60

索引

掃描鏡，清潔，81
略過響鈴，35
設定中斷複印，67
設定半色調，45
設定打印對比度，17
設定接收比例，64
設定清單，77

十二劃

喇叭音量，23
虛擬響鈴持續時間，57

十三劃

傳真紙，更換，14
傳真接收模式，22，59
傳真接收模式的響鈴次數，59
傳送方姓名和號碼，輸入，18-19
僅限 OGM 模式，31
節省費用功能，27
解像度，45
電源線，10
電話/傳真代碼，63
電話/傳真接收模式，22，57
電話分機
 連接，13
電話接收模式，22，60
電話號碼清單，77
電話線，11

十四劃

對比度，46
遙距代碼，37
遙距操作，37

十五劃

撥號
 一般，47
 自動，51
 直接按鍵，52
撥號模式，11
線路錯誤，83
複印，66

十六劃

機殼，清潔，82

十七劃

優先來電，71
儲存，替代接收，65
聲頻信號，89

十八劃

轉接功能，32

二十一劃

響鈴音量，24

二十二劃

聽筒，10

二十三劃

顯示屏信息，87

遙距操作卡

以下卡片可用作遙距操作的快速參考指南。請剪下本卡片並在外出時隨身攜帶。

遙距操作指南

SHARP®

1. 使用按鍵式電話撥打您的傳真機號碼，然後在外出留言信息開始播放時按下 **#**。
2. 輸入遙距代碼：
3. 按 **#**。
4. 聽取信息後，您可掛上聽筒以儲存信息，或輸入背面所列的其中一個指令。

遙距指令

• 播放

播放信息	7	#
回轉/重複	2	#
往前略過	5	#
停止	0	#
僅播放新信息 (先停止播放)	6	#

• 清除信息

清除一則信息	3	#	
清除所有信息	3	3	#

• 錄製備忘

開始	*	#
結束	0	#

• 錄製新 OGM

開始	4	*
----------	---	---

• 傳真接收模式

留言機模式	8	1	#
傳真模式	8	2	#
電話模式	8	3	#
電話/傳真模式	8	4	#

• 轉接功能

開啟	9	1	#
關閉	9	2	#
新轉接號碼	9	0	#
錄製轉接 OGM	9	3	#
快速中斷連接	*	*	#

→ (電話號碼) #

• 僅限 OGM 模式

開啟	1	1	#
關閉	1	2	#

SHARP CORPORATION

PRINTED IN THAILAND
(TINSQ4406XHTZ)