

Copyright

Fujitsu Limited has made every effort to ensure the accuracy and completeness of this document. However, as ongoing development efforts are continually improving the capabilities of our products, we cannot guarantee the accuracy of the contents of this document. We disclaim liability for errors, omissions, or future changes.

LifeBook is a trademark of Fujitsu Limited.

Microsoft, Windows, MS, MS-DOS, and Windows NT are registered trademarks of the Microsoft Corporation of the United States in the United States and other countries.

Intel is a registered trademark of the Intel Corporation of the United States.

Phoenix is a registered trademark of Phoenix Technologies Corporation of the United States.

K56flex is a trademark of Rockwell International Corporation and Lucent Technologies Corporation.

Other product names are trademarks or registered trademarks of their respective companies.

Other products are copyrighted by their companies.

Copyright© 1981-2001 Microsoft Corporation, All rights reserved.

Copyright© 2001 Phoenix Technologies, Ltd., All rights reserved.

All other products are trademarks or registered trademarks of their respective companies.

© Copyright 2003 Fujitsu Limited. All rights reserved. No part of this publication may be copied, reproduced, or translated, without the prior written consent of Fujitsu Limited. No part of this publication may be stored or transmitted in any electronic form without the written consent of Fujitsu Limited.

Website: www.fujitsu-pc-asia.com



DECLARATION OF CONFORMITY according to FCC Part 15

This device complies with Part 15 of the FCC rules. Operations are subject to the following two conditions:
(1) This device must not be allowed to cause harmful interference, (2) This device must accept any interference received, including interference that may cause undesired operation.

CAUTION

Changes or modification not expressly approved by Fujitsu could void this user's authority to operate the equipment.

FCC NOTICES

Notice to Users of Radios and Television

These limits are designed to provide reasonable protection against harmful interference in a residential installation. This equipment generates, uses, and can radiate radio frequency energy and, if not installed and used in accordance with the instructions, may cause harmful interference to radio communications. However, there is no guarantee that interference will not occur in a particular installation. If this equipment does cause harmful interference to radio or television reception, which can be determined by turning the equipment off and on, the user is encouraged to try to correct the interference by one or more of the following measures:

- Reorient or relocate the receiving antenna.
- Increase the separation between the equipment and receiver.
- Connect the equipment into an outlet that is on a different circuit than the receiver.
- Consult the dealer or an experienced radio/TV technician for help.

Shielded interconnect cables must be employed with this equipment to ensure compliance with the pertinent RF emission limits governing this device.

Notice to Users of the US Telephone Network

Your LifeBook notebook may be supplied with an internal modem which complies with Part 68 of the FCC rules. On this notebook is a label that contains the FCC Registration Number and the Ringer Equivalence Number (REN) for this equipment among other information. If requested, the user must provide their telephone company with the following information:

1. The telephone number to which the notebook is connected.
2. The Ringer Equivalence Number (REN) for this equipment.
3. That the equipment requires a standard modular jack type USOC RJ-11C which is FCC Part 68 compliant.
4. The FCC Registration Number.

This equipment is designed to be connected to the telephone network or premises wiring using a standard modular jack type USOC RJ-11C which is FCC Part 68 compliant and a line cord between the modem and the telephone network with a minimum of 26AWG.

The REN is used to determine the number of devices that you may connect to your telephone line and still have all of those devices ring when your number is called. Too many devices on one line may result in failure to ring in response to an incoming call. In most, but not all, areas the sum of the RENs of all of the devices should not exceed five (5). To be certain of the number of devices you may connect to your line, as determined by the RENs, contact your local telephone company.

If this equipment causes harm to the telephone network, your telephone company may discontinue your service temporarily. If possible, they will notify you in advance. If advance notice is not practical they will notify you as soon as possible. You will also be advised of your right to file a complaint with the FCC.

This fax modem also complies with fax branding requirements per FCC Part 68.

Your telephone company will probably ask you to disconnect this equipment from the telephone network until the problem is corrected and you are sure that the equipment is not malfunctioning. This equipment may not be used on coin-operated telephones provided by your telephone company. Connection to party lines is subject to state tariffs. Contact your state's public utility commission, public service commission or corporation commission for more information.

This equipment includes automatic dialing capability. When programming and/or making test calls to emergency numbers:

- Remain on the line and briefly explain to the dispatcher the reason for the call.
- Perform such activities in off-peak hours, such as early morning or late evening.

FCC rules prohibit the use of non-hearing aid compatible telephones in the following locations or applications:

- All public or semipublic coin-operated or credit card telephones.
- Elevators, highways, tunnels (automobile, subway, railroad or pedestrian) where a person with impaired hearing might be isolated in an emergency.
- Places where telephones are specifically installed to alert emergency authorities such as fire, police or medical assistance personnel.
- Hospital rooms, residential health care facilities, convalescent homes and prisons.
- Workstations for the hearing impaired.
- Hotel, motel or apartment lobbies.
- Stores where telephones are used by patrons to order merchandise.
- Public transportation terminals where telephones are used to call taxis or to reserve lodging or rental cars.
- In hotel and motel rooms as at least ten percent of the rooms must contain hearing aid compatible telephones or jacks for plug-in hearing aid compatible telephones which will be provided to hearing impaired customers on request.

DOC (INDUSTRY CANADA) NOTICES

Notice to Users of Radios and Television

This Class B digital apparatus meets all requirements of the Canadian Interference-Causing Equipment Regulations.

CET appareil numérique de la class B respecte toutes les exigence du Règlement sur le matériel brouilleur du Canada.

Notice to Users of the Canadian Telephone Network

The Canadian Industry Canada label identifies certified equipment. This certification means that the equipment meets certain telecommunications network protective, operational, and safety requirements. The Department does not guarantee the equipment will operate to the user's satisfaction.

LifeBook notebooks are supplied with an internal modem which complies with the Industry Canada certification standards for telecommunication network protection and safety requirements. Before connecting this equipment to a telephone line the user should ensure that it is permissible to connect this equipment to the local telecommunication facilities. The user should be aware that compliance with the certification standards does not prevent service degradation in some situations.

Repairs to telecommunication equipment should be made by a Canadian authorized maintenance facility. Any repairs or alterations not expressly approved by Fujitsu PC Corporation or any equipment failures may give the telecommunication company cause to request the user to disconnect the equipment from the telephone line.

The connecting arrangement code for this equipment is CA11A.

The Load Number assigned to each telephone terminal device denotes the percentage of the total load to be connected to a telephone loop or circuit which is used by the device to prevent overloading. The termination on a loop may consist of any combination of devices such that the total of the load numbers of all devices does not exceed 100.



CAUTION

For safety, users should ensure that the electrical ground of the power utility, the telephone lines and the metallic water pipes are connected together. Users should NOT attempt to make such connections themselves but should contact the appropriate electric inspection authority or electrician. This may be particularly important in rural areas.

UL Notice

This unit requires an AC adapter to operate. Use only UL Listed Class 2 adapter, output rating 16V DC, 3.75A. Refer to the illustration below for the correct AC Adapter output polarity:



CAUTION

To reduce the risk of fire, use only #26 AWG or larger telecommunications line cord.

For Authorized Repair Technicians Only

CAUTION

For continued protection against risk of fire, replace only with the same type and rating fuse.

WARNING

Danger of explosion if Lithium (CMOS) battery is incorrectly replaced. Replace only with the same or equivalent type recommended by the manufacturer. Dispose of used batteries according to the manufacturer's instruction.

IMPORTANT SAFETY INSTRUCTIONS

1. Read these instructions carefully. Save these instructions for future reference.
2. Follow all warnings and instructions marked on the product.
3. Unplug this product from the wall outlet before cleaning. Do not use liquid cleaners or aerosol cleaners. Use a damp cloth for cleaning.
4. Do not use this product near water.
5. Do not place this product on an unstable cart, stand, or table. The product may fall, causing serious damage to the product.
6. Slots and openings in the cabinet and the back or bottom are provided for ventilation; to ensure reliable operation of the product and to protect it from overheating, these openings must not be blocked or covered. The openings should never be blocked by placing the product on a bed, sofa, rug, or other similar surface. This product should never be placed near or over a radiator or heat register, or in a built-in installation unless proper ventilation is provided.
7. This product should be operated from the type of power indicated on the marking label. If you are not sure of the type of power available, consult your dealer or local power company.
8. This product is equipped with a 3-wire grounding-type plug, a plug having a third (grounding) pin. This will only plug into a grounding-type power outlet. This is a safety feature. If you are unable to insert the plug into the outlet, contact your electrician to replace your obsolete outlet. Do not defeat the purpose of the grounding-type plug.
9. Do not allow anything to rest on the power cord. Do not locate this product where persons will walk on the cord.
10. If an extension cord is used with this product, make sure that the total ampere rating of the equipment plugged into the extension cord does not exceed the extension cord ampere rating. Also, make sure that the total rating of all products plugged into the wall outlet does not exceed 15 amperes.
11. Never push objects of any kind into this product through cabinet slots as they may touch dangerous voltage points that could result in a fire or electric shock. Never spill liquid of any kind on the product.
12. Do not attempt to service this product yourself, as opening or removing covers may expose you to dangerous voltage points or other risks. Refer all servicing to qualified service personnel.
13. Unplug this product from the wall outlet and refer servicing to qualified service personnel under the following conditions:
 - a. When the power cord or plug is damaged or frayed.
 - b. If liquid has been spilled into the product.
 - c. If the product has been exposed to rain or water.
 - d. If the product does not operate normally when the operating instructions are followed. Adjust only those controls that are covered by the operating instructions since improper adjustment of other controls may result in damage and will often require extensive work by a qualified technician to restore the product to normal condition.
 - e. If the product has been dropped or the cabinet has been damaged.
 - f. If the product exhibits a distinct change in performance, indicating a need for service.
14. **CAUTION. When replacing the battery, be sure to install it with the polarities in the correct position. There is a danger of explosion if the battery is replaced with an incorrect type or is mistreated. Do not recharge, disassemble or dispose of in fire. Replace only with the same or equivalent type recommended by the manufacturer. Dispose of the used battery according to the manufacturer's instructions.**
15. Use only the proper type of power supply cord set (provided in your accessories box) for this unit. It should be a detachable type: UL listed/CSA certified, BS1363, ASTA, SS145 certified, rated 10A 250V minimum, VDE approved or its equivalent. Maximum length is 15 feet (4.6 meters).

High Safety Required Use

This Product is designed, developed and manufactured as contemplated for general use, including without limitation, general office use, personal use, household use and ordinary industrial use, but is not designed, developed and manufactured as contemplated for use accompanying fatal risks or dangers that, unless extremely high safety is secured, could lead directly to death, personal injury, severe physical damage or other loss (hereinafter 'High Safety Required Use'), including without limitation, nuclear power reaction core control in nuclear atomic facility, airplane automatic aircraft flight control, air traffic control, operation control in mass transport control system, medical instrument for life support system, missile launching control in weapon system. You shall not use this Product without securing the sufficient safety required for the High Safety Required Use.

DATA STORAGE MEDIA AND CUSTOMER RESPONSIBILITIES

The only effective protection for the data stored in a computer, such as on a hard disk, is for you, Purchaser to regularly back up the data. Fujitsu and its affiliates, suppliers, service providers and resellers shall not be responsible for any software programs, data or other information stored or used on any media or part of any Product returned to Fujitsu or its service providers for Warranty Service or other repair, including but not limited to the costs of recovering such programs, data or other information. It is solely your responsibility as the Purchaser to back up any software programs, data, or information stored on any storage media or any part of a Product returned for Warranty Service or repair to the designated service centers.

AUSTRALIAN WARNINGS

WARNING

FOR SAFETY REASONS, ONLY CONNECT EQUIPMENT WITH A TELECOMMUNICATIONS COMPLIANCE LABEL. THIS INCLUDES CUSTOMER EQUIPMENT PREVIOUSLY LABELLED PERMITTED OR CERTIFIED.

Connection of Non Certified/Approved peripherals may result in the equipment operating outside the Australian EMI Standards.

Modems connected to the Australian telecommunications network must be operated in accordance with the Labelling Notice. This modem has been specifically configured to ensure compliance with the ACA Standards. Do not adjust your modem or software outside the values indicated below. To do so would result in your modem being operated in a non-compliant manner.

Call Attempts/Retries:

Applications software shall be configured so that no more than 3 attempts are made to establish a connection to a given number (Note: if the modem can detect service tones, up to 10 attempts can be made). If the call sequence is unsuccessful, there shall be a delay of at least 30 minutes before attempting to call the number again.

Failure to set the modem, and any application software used with the modem, to the values shown above will result in the modem being operated in a non-compliant manner. Consequently, this would be in violation of the Labelling Notice for this equipment, and the Telecommunications Act 1997 prescribes penalties for the connection of non-compliant equipment.

NEW ZEALAND WARNINGS

The grant of a Telepermit for any item of terminal equipment indicates only that Telecom has accepted that the item complies with minimum conditions for connection to its network. It indicates no endorsement of the product by Telecom, nor does it provide any sort of warranty. Above all, it provides no assurance that any item will work correctly in all respects with another item of Telepermitted equipment of a different make or model, nor does it imply that any product is compatible with all of Telecom's network services.

This equipment is not capable under all operating conditions of correct operation at the higher speeds for which it is designed. 56 KBPS connections are likely to be restricted to lower bit rates when connected to some PSTN implementations. Telecom will accept no responsibility should difficulties arise in such circumstances.

Immediately disconnect this equipment should it become physically damaged, and arrange for its disposal or repair.

This equipment shall not be used in any manner, which could constitute a nuisance to other Telecom customers.

This equipment shall not be set to make automatic calls to the Telecom "111" Emergency Service. This device is equipped with pulse dialling while the New Zealand standard is DTMF tone dialling. There is no guarantee that Telecom lines will always continue to support pulse dialling. It is strongly recommended that pulse dialling is not used.

Some parameters required for compliance with Telecom's Telepermit requirements are dependent on the equipment (PC) associated with this device. The associated equipment shall be set to operate within the following limits for compliance with Telecom's Specifications:

For repeat calls to the same number.

There shall be no more than 10 call attempts to the same number within any 30 minute period for any single manual call initiation, and

The equipment shall go on-hook for a period of not less than 30 seconds between the end of one attempt and the beginning of the next attempt.

For Automatic calls to different numbers.

The equipment shall go on-hook for a period of not less than 5 seconds between the end of one attempt and the beginning of the next attempt.

For Automatically answered Incoming Calls

Incoming calls shall be answered between 3 and 30 seconds from the start of the ringing.

For correct operation, the total of the RNs of all devices connected to a single line at anytime should not exceed 5. The RN of this Equipment is 0.5.

WARNING

Connection of Non Certified/Approved peripherals may result in the equipment operating outside the New Zealand EMI Standards.

Note: Modem setting in Windows XP

A. If you are located in Australia

1. Click Start select Control panel select "Phone and Modem Options".
2. Double click New Location.
3. Choose "Australia" in Country/region pull down menu bar.
4. Select Phone system as "Tone Dialing".
5. Click OK and Apply.

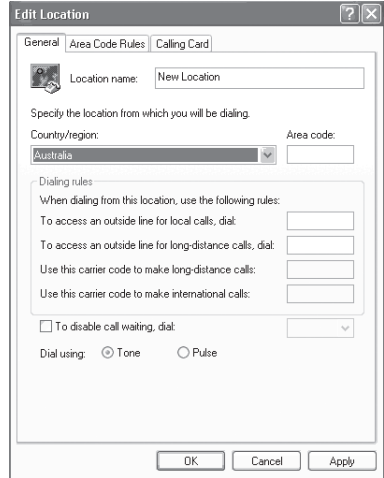

B. If you are located in New Zealand

1. Click start select Control panel select "Phone and Modem Options".
2. Double click New Location.
3. Choose "New Zealand" in Country/region pull down menu bar.
4. Select Phone system as "Tone Dialing".
5. Click OK and Apply.

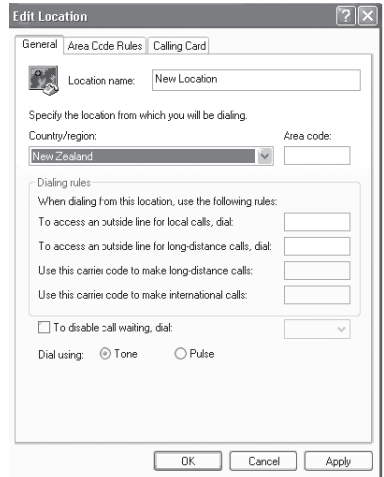



Note:

The screens and illustrations shown in this examples may slightly vary depending on the operating environment that you have installed.







NOTATION IN THIS DOCUMENT

● Warnings

This manual uses a variety of icons as visual marks so that you can use this computer safely and correctly and avoid damage and danger to yourself and to others. These icons and their meanings are as follows. Please learn these icons before reading this manual. Learning these icons will be useful for understanding this manual.

Icon	Meaning
 WARNING	Incorrect handling ignoring this warning can cause a dangerous situation that could result in death or severe injury.
 CAUTION	Incorrect handling ignoring this warning can cause a dangerous situation that could result in moderate or minor injury or could result in equipment damage.

The symbols below are used together with the icons above to indicate what type of danger or damage is involved.

symbols	Meaning
	The symbol  indicates warning or caution. The symbol  indicates the concrete nature of the warning. (The example on the left is a caution for electric shock.)
	The circle and slash indicates prohibited behavior. The symbol inside the circle indicates the concrete nature of the prohibition. (The example on the left indicates that disassembly is prohibited.)
	The  indicates instructions that must be followed. The symbol inside indicates the concrete nature of those instructions. (The example on the left tells you to unplug the power plug from the socket.)

● Key notation and operation methods

Explanations of key operations do not show all the characters on the keyboard. Instead they indicate just the keys necessary to the explanation as follows.

Examples: **[Ctrl]** key, **[Enter]** key, **[→]** key

When multiple keys are to be pressed at the same time, this is indicated by connecting them with **[+]**.

Examples: **[Ctrl] + [F3]** keys; **[Shift] + [↑]** key

● Screen examples

The screens shown in this manual are examples. Please understand that the file names and screens you use may be different.

● Notation in text

Here is what symbols in text mean.

Symbol	Meaning
Critical Points	Critical Point Indicates a point necessary for correctly operating the hardware or software.
 Column	Column Gives the meaning and brief explanation of a term.
→	Indicates the page to see elsewhere in this manual.

● Command input (key input)

Within the text of this manual, command input (giving commands to the computer by pressing keys) is indicated as follows.

Example: `dir c:`



In the position indicated in the example above by the ↑, the space left between the characters indicates that a space needs to be left in the entry by pressing the space bar (the long key with nothing written on it at the center of the front of the keyboard). Commands are written in this manual as lowercase latin letters, but uppercase letters may be used.

● Product names

The following product names are abbreviated as follows in this manual.

“Microsoft® Windows XP® operating system” is written as “Windows XP”.

“Microsoft® Windows® 2000 operating system” is written as “Windows 2000”.

“LifeBook” is written as “this computer” or “the computer main unit”.

Configuration of this Manual

SECTION 1

This section explains basic operations and basic items for using this computer, including the names of the parts and their functions, flat point operation methods, floppy disk unit handling, and battery operation.

SECTION 2

This section explains installation of options for this computer.

SECTION 3

This section explains what to do when trouble occurs with this computer and when messages are displayed. Read this section as the necessity arises.

CONTENTS

SECTION 1

1	Names of the Parts and their Functions	2
	Exterior features: Front/top view	2
	Exterior features: Side view	4
	Exterior features: Top and bottom view of the computer	7
	Exterior features: Rear view of the computer	8
	Exterior features: Operating Status indicator LCD	10
2	Port Replicator	12
	Installing the Port Replicator	14
	Removing the Port Replicator	15
3	Pointing Device	16
	About the Flat Point	16
	How to use the Flat Point	17
4	Keyboard	19
	Keyboard	19
5	Changing the Internal Battery Pack	23
6	Running the computer on its battery	25
7	Using a LAN	29
	Using a wired LAN	29
8	About the built-in Modem	32
9	LifeBook Security/Application Panel	34
	LifeBook Security / Application Panel	34
	Setting up your LifeBook Security Panel	34
	Passwords	35
	Operating your LifeBook Security/Application Panel	36
	Precautions	37
	Uninstalling the security Panel Application	37
	Configuring your LifeBook Application Panel	39
	Configure your E-mail Account Settings	42
	Desktop Control Panel	47
10	Wireless LAN (For selected model)	34
	Preface	49
	Notice to the User	50
	Outline	53
	Features of the wireless LAN function	53
	Network configuration of the wireless LAN	53
	For better communications	55
	Stopping the transmission of radio waves	56
	Starting the transmission of radio waves	56

Connection Using Windows XP	57
Preparation for Wireless LAN Connection	58
Assigning parameters	58
Connection to the network	61
Setting the network	61
Setting the sharing function	63
Confirming connection	65
Connection Using Windows 2000	67
Preparation for Wireless LAN Connection	68
Assigning parameters	68
Connection to the network	71
Setting the network	71
Setting the sharing function	73
Confirming connection	75
Setting of transmission power during ad hoc connection	77
Appendix	77
Setting of power-saving function	77
Setting of transmission power during ad hoc connection	77
Setting of channels during ad hoc connection	78
Troubleshooting	79
Unavailable connection to the network	79
Connection check with executed PING command	83
Disconnected communication a few minutes after every connection to the station	83

SECTION 2

1 Options	86
Peripherals	87
2 Adding Memory	88
3 Connecting a USB Device	94
Connecting a USB device	95
4 Connecting an External Monitor	96
Connecting an external monitor	96

SECTION 3

1	When This Happens	100
2	Care and Maintenance	105

SECTION

1

This section explains basic operations and basic items for using this computer, including the names of the parts and their functions, Flat point operation methods, floppy disk unit handling, and battery operation.

1 Names of the Parts and their Functions

Exterior features: Front/top view

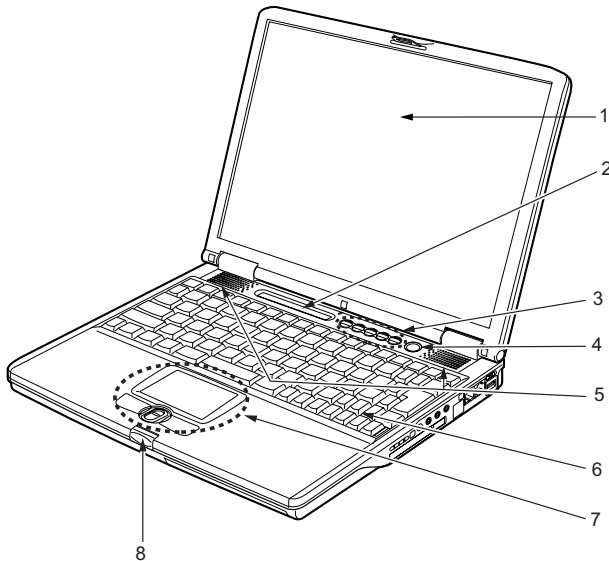

(Your computer or situation may not look exactly like this illustration.)

1. LCD panel

Displays images output by the computer.

Critical Points

◆ About the properties of LCD screens

The phenomena below are inherent in the properties of LCD screens and do not indicate that LCD screens are faulty.

- The TFT color LCD screen of your computer, composed of more than 2,350,000 picture elements or pixels (number of dots when the screen resolution is set at 1024 by 768 pixels), was manufactured through the use of high technologies. For technical reasons, your LCD screen may have pixels that do not light and pixels that are always lit, which however does not indicate that your LCD screen is faulty.
- Colors reproduced by LCD screens for computers vary to some extent from product to product for reasons of manufacture. Also, a slight unevenness of density may show up because of changes in temperature.

Using the LCD screen in low light for a long period of time could shorten the life of its components.

2. Operating status indicator LCD

Displays the operating status of the computer.

3. LifeBook Security/Application Panel

The LifeBook Security/Application Panel provides hardware security and one-touch application launch capability.

4. Power and Suspend/Resume Button

The Power and Suspend/Resume button is always used to Power On your LifeBook notebook from its Off state. It is also used as the Suspend/Resume button. This allows you to suspend notebook activity without powering off, resume your notebook from suspend mode, and power on your LifeBook notebook when it has been shut down.

5. Speakers

Sound output devices of the computer

6. Keyboard

Used to type characters and enter commands in your computer.

7. Flat Point

Used to control the mouse pointer. The scroll button in the middle allows you scroll up and down through the document in the active window.

Critical Points

◆ Some applications may not allow you to scroll up and down through a document, using the scroll button.

8. Latch

Used to lock the LCD panel to prevent it from opening accidentally.
To unlock the LCD panel, slide the knob to the right.

Exterior features: Side view

❑ Right view of the computer

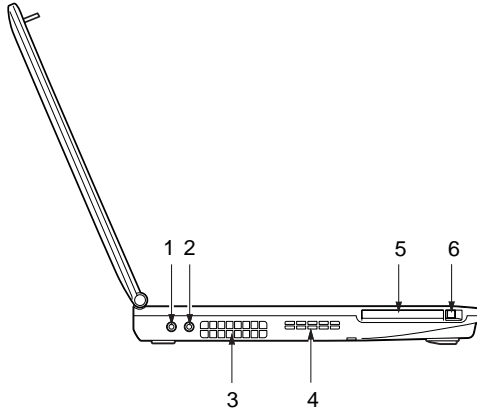

(Your computer or situation may not look exactly like this illustration.)

1. Headphone jack

- Headphone jack
Used to connect commercially available headphones with a 3.5 mini plug. This jack is incompatible with some types of cable connectors, so you should consult a salesperson before purchasing headphones.

CAUTION

HEARING LOSS



- When you are listening to music with headphones, do not turn up the volume excessively. Listening to very loud sounds for a long time can adversely affect your hearing.

HEARING LOSS



- When you are wearing headphones plugged into the computer, do not turn on or off the computer, or very loud sounds may adversely affect your hearing.

2. Microphone jack

Used to connect a commercially available monaural microphone with a f3.5 mini plug. This jack does not support some types of microphones (e.g., dynamic microphone), so you should consult a salesperson before purchasing a microphone.

3. Air outlet

Provide to discharge heat from the computer. When you turn on the computer, the cooling fan rotates for a few seconds. When the temperature in the computer rises high, it automatically starts to rotate to discharge heat from the computer.

 CAUTION

BREAKAGE

- Do not block the air outlet. Doing so prevents heat from being discharged and could result in damage to your computer.

4. Air inlet

Allows the cooling fan to draw outside air into your computer.

 CAUTION

BREAKAGE

- Do not block the air inlet. Doing so prevents heat from being discharged and could result in damage to your computer.

5. PC card slot

Used to insert PC cards.

6. PC card eject button

Press this button to eject the PC card.

❑ Left view of the computer

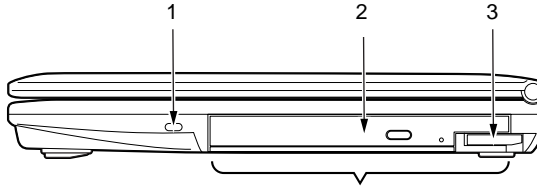

(Your computer or situation may not look exactly like this illustration.)

1. Antitheft lock

Used to connect a commercially available antitheft cable.

Critical Points

- ◆ The antitheft lock supports Kensington™ Micro Saver Security System.
 - When connecting the antitheft lock, you cannot remove the mobile multi-purpose bay unit.

2. Mobile multi-purpose bay

Your computer came with an internal optical disk drive, which may vary between countries. Please check with your local distributor for actual configuration. You may change the optical disk drive installed in this bay with other bay options, which are sold separately".

Critical Points

- ◆ To avoid damage to your computer, do not leave the mobile multi-purpose bay empty when using the computer.

3. Bay unit release lever

Raise this lever to remove the unit from the mobile multi-purpose bay.

Exterior features: Top and bottom view of the computer

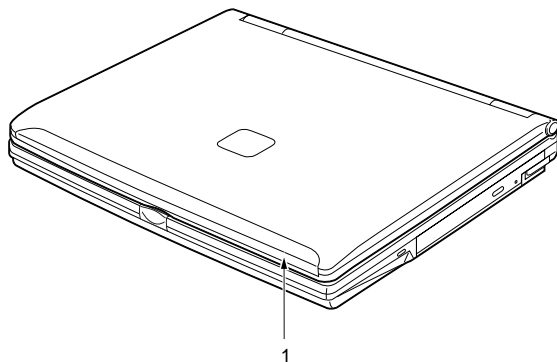

1. Built-in wireless LAN antenna*

A wireless LAN antenna is built in here.

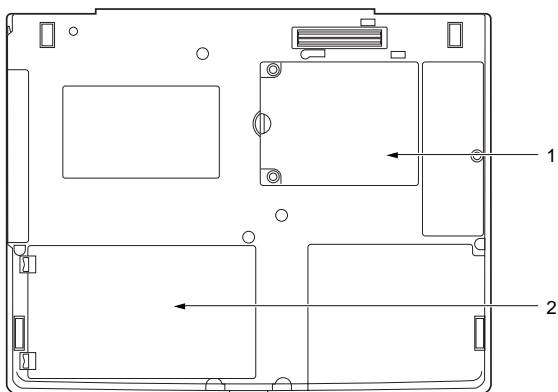

(Your computer or situation may not look exactly like this illustration.)

1. Expansion RAM module slot

Accommodates the memory of your computer.

2. Internal battery pack bay

Accommodates an internal battery pack.

Note:

For model with WireLess LAN Module installed.

Exterior features: Rear view of computer

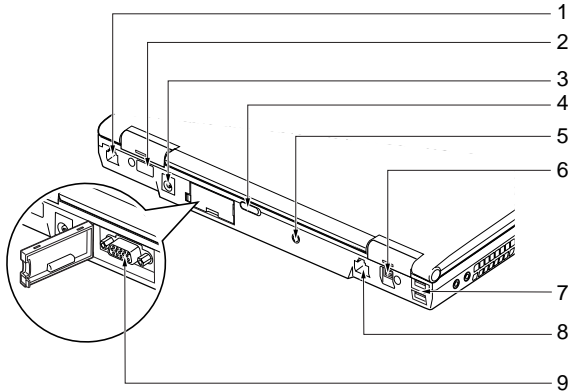

(Your computer or situation may not look exactly like this illustration.)

1. Modem port

Used to connect the computer to a phone line via the supplied modular cable when using a Online service or navigating the Internet.

2. Infrared Port

The fast IrDA compatible port allows you to communicate with another IrDA compatible infrared device without a cable.

3. DC-IN jack

Used to connect the AC adapter included with your computer.

4. Wireless switch

Used to switch the wireless devices on and off.

5. Line-In jack

This is an analog input terminal used to connect the computer to the Line-Out terminal of an AV system (with a 3.5mm mini plug).

CAUTION

HEARING LOSS



- Before connecting headphones or a microphone to your computer, always turn down your computer's master volume to a minimum by pressing the F8 key while holding down the Fn key.

Failure to do so could result in damage to the audio unit connected or could adversely affect your hearing.

6. **IEEE*1394 (DV) port (*: Pronounced “ai triple-e”)**
Used to connect a peripheral device, such as a digital video camera (DV), to the computer via a DV cable.
7. **USB ports**
Used to connect USB-compliant peripheral devices, such as an optionally available USB floppy disk drive and a USB printer.
8. **LAN port**
Used to connect the computer to a LAN (local area network) via an optional LAN cable for using Online service or navigating the Internet.
9. **External monitor port**
Used to connect an optionally available external monitor.

IMPORTANT

- When connecting an external device to your computer, insert its connector straight into the port with the right side up.

Exterior features: Operating status indicator LCD

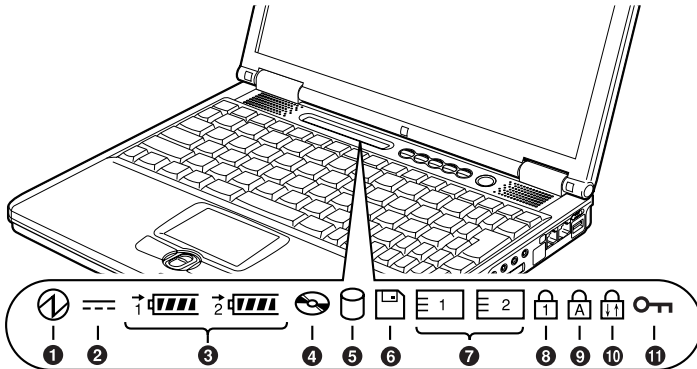

(Your computer or situation may not look exactly like this illustration.)

Critical Points

- ◆ When you turn off your computer, all indicators on the operating status indicator LCD will go off, except when the battery in your computer is being charged.

1. SUS/RES Indicator (①)

Lights when the computer is in operation and blinks when it is on standby.

2. AC Adapter Indicator (≡)

Lights when the computer is powered from the AC adapter.

3. Battery loading indicator (1, 2, [])

Lights when a battery pack is installed in your computer. The numbers 1 and 2 denote the internal battery pack and the add-on battery unit (optional) installed in the mobile multi-purpose bay, respectively.

Charging status indicator (→)

Lights when the internal battery is being charged.

Battery life indicator ([])

Indicates the remaining life of the internal battery pack.





4. CD Access Indicator ([])

Lights when the CD/DVD drive is being accessed.

5. **Hard Disk Access Indicator** ()
Lights when the hard disk is being accessed.

Critical Points

- ◆ To prevent the corruption of data recorded on the hard disk, do not press the power button when the hard disk access indicator is lit.

6. **Floppy Disk Drive Access Indicator** ()
The Floppy Disk Drive Access indicator states whether the floppy disk drive is being accessed. This indicator will flash if your software tries to access a disk even if no floppy disk drive is installed.
7. **PC Card Access Indicator** ()
Light when a PC card is being accessed.
8. **Num Lock Indicator** ()
Lights when the keyboard is locked in Num Lock mode (in which you can use the keyboard as a ten-digit keypad).
To enter or exit Num Lock mode, press the **[Num Lk]** key.
9. **Caps Lock Key** ()
Lights when the keyboard is locked in Caps Lock mode (in which you can enter uppercase letters without pressing and holding down the Shift key).
To enter or exit Caps Lock mode, press the Caps Lock key while holding down the **[CapsLock]** key.
10. **Scroll Lock Indicator** ()
Lights when the active window is locked to prevent it from being scrolled up or down.
To enter or exit Scroll Lock mode, press the **[Scr Lk]** key while holding down the **[Fn]** key.
11. **Security Indicator**
The Security Indicator flashes (if a password was set) when the system resumes from Off or Suspend modes.
You must enter the password that was set in the SecurityPanel before your system will resume operation.

2 Port Replicator

The port replicator is described here.

□ Port Replicator back panel.

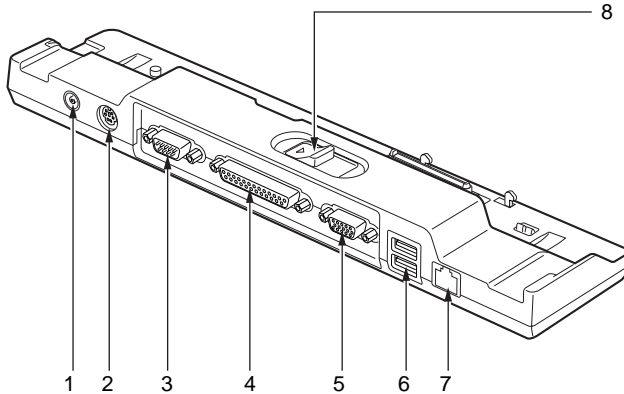

(Your computer or situation may not look exactly like this illustration.)

Back Panel Components

The following is a brief description of the Port Replicator back panel components.

1. **DC Power Jack**
The DC Power Jack allows you to plug in the AC Adaptor to power on your notebook.
2. **PS/2 Keyboard/Mouse Port.**
The PS/2 port allows you to connect an external PS/2 keyboard or mouse.
3. **Serial Port**
The serial port allows you to connect serial devices.
4. **Parallel Port**
The parallel port allows you to connect parallel devices.
5. **External VGA Port**
The external VGA port allows you to connect an external VGA or SVGA CRT monitor.
6. **USB Port**
The USB allows you to connect USB devices.
7. **Lan (RJ-45) Jack**
The LAN port allows you to connect a LAN (RJ-45).
Note that when your notebook is connected to the Port Replicator, the LAN port on the system is not accessible, the Port Replicator LAN port is the only one that should be used when it is attached to the system.
8. **Port Replicator Release Latch**
Slide the Port Replicator Release button to remove the Port Replicator from your notebook.

□ Port Replicator front panel.

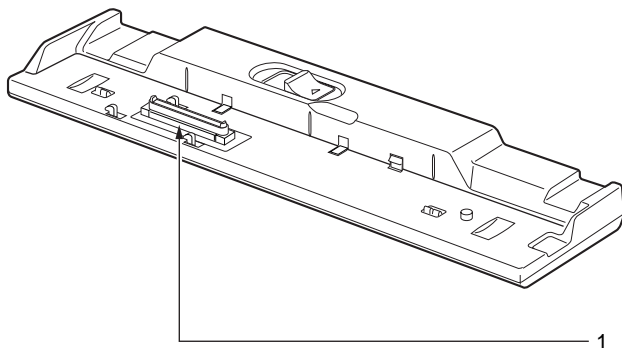

(Your computer or situation may not look exactly like this illustration.)

Front Panel Components

The following is a brief description of the Port Replicator front panel components.

1. Docking Port

The docking port connects the Port Replicator to your notebook.

IMPORTANT

- Certain peripheral devices connected to the port replicator may operate unstably if the port replicator is installed/removed while the PC power is on. If this happens, switch the PC power off prior to installing/removing the port replicator.

Installing the Port Replicator

This section describes how to install the port replicator.

If any peripheral device is connected to the PC rear side, remove it beforehand.

CAUTION

INJURY



- Be careful not to catch your fingers in the space between the PC and the port replicator when installing it. It may cause an injury.

1. Install the port replicator to the PC bottom side.

Fitting the connectors on the PC and the port replicator, lower the PC horizontally (1), lightly press the parts shown below (2), and firmly set the port replicator.

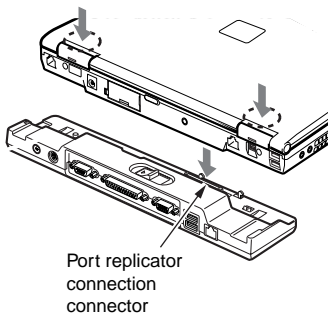

(Your computer or situation may not look exactly like this illustration.)

IMPORTANT

- To install a peripheral device to or remove it from the port replicator, be sure to switch the PC power off and disconnect the AC adapter in advance.
- Do not carry the PC with the port replicator installed. The connectors on the PC and/or the port replicator may be damaged.

Removing the Port Replicator

This section describes how to remove the port replicator.

1. **If any peripheral device is connected to the port replicator, switch the power off.**
2. **Release the port replicator lock.**
Release the lock by sliding the port replicator removal lever.

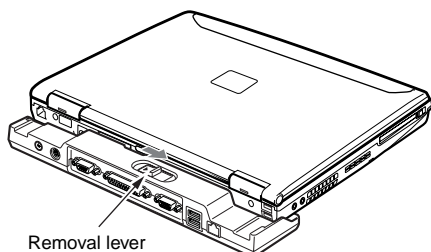

3. **Remove the port replicator.**
While keeping the removal lever in the unlocking position (1), lift the side having the connector first (2) then the other side of the PC (3) to remove the port replicator.

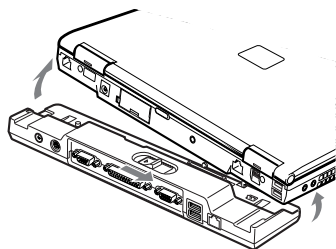

(Your computer or situation may not look exactly like this illustration.)

3 Pointing Device

About the Flat Point

The Flat Point is a handy pointing device that enables you to move the mouse pointer freely with your finger. It consists of a touch-pad, left and right buttons on this side of the touch-pad, and the scroll button between the left and right buttons.

The touch-pad has the same function as the ball in a mouse. You can move the mouse pointer in any directions on the screen by sliding the tip of a finger on the touch-pad. Moreover, if you tap the touch-pad with a finger, you can click, double-click, point to, or drag any object on the screen.

The left and right buttons correspond to the left and right buttons of a mouse, and their functions vary from application to application.

Pressing the scroll button forward or backward enables you to easily scroll a window up or down.

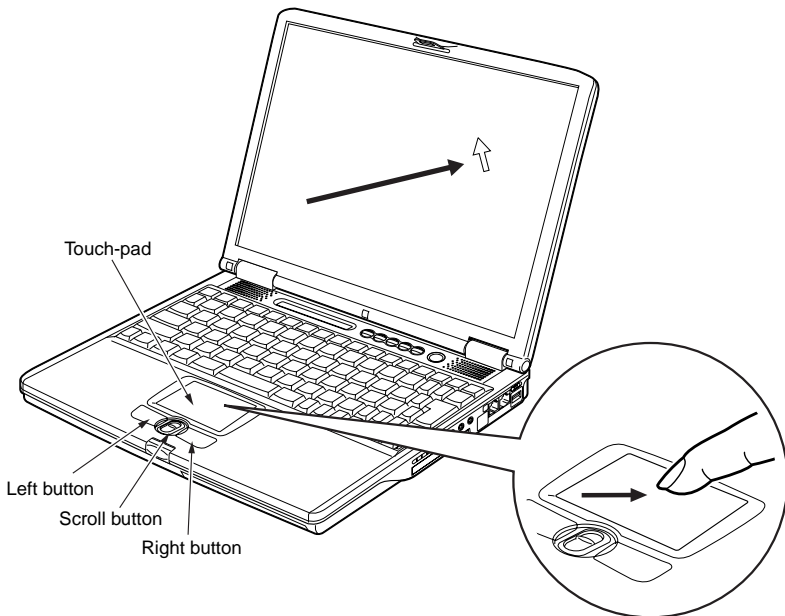

(Your computer or situation may not look exactly like this illustration.)

Critical Points

- ◆ The Flat Point may malfunction if condensation occurs or if it is moistened. In addition, if you operate it with a moistened or sweaty finger, or if the Flat Point surface is dirty, the mouse pointer may not move correctly. In such a case, turn off your computer and wipe dirt off with a soft cloth slightly dampened with dilute detergent.
- ◆ Some applications do not allow you to use the scroll button to scroll windows.
- ◆ You can use an optionally available USB mouse instead of the Flat Point.

How to use the Flat Point

- **Click**

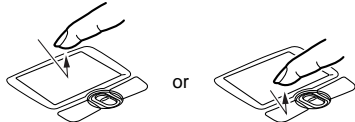

“Click” means quickly pressing the left button once or tapping the touch-pad once. Pressing the right button once is called “right-click.”

- **Double-click**

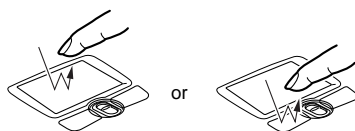

“Double-click” means pressing the left button twice in a row or tapping the touch-pad twice in a row.

- **Point**

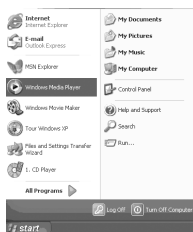

“Point to an item” means moving the mouse pointer onto a menu item, and so on, to select it. Pointing to an item highlights it and displays an explanation about it. If the item to which you pointed has a submenu (such items are marked with ▶), the submenu appears.

- **Drag**

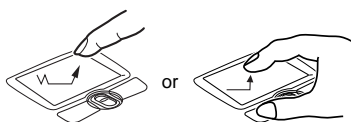

To drag an object, move the mouse pointer onto the object, move the object to the desired location by sliding the finger on the touch-pad while holding the left button down, and then move the finger off the pad. Or, move the mouse pointer onto the object, and tap the touch-pad twice in a row. After that, without moving the finger off the pad, slide it to move the object to the desired location, and then move the finger off the pad.

- **Scroll**

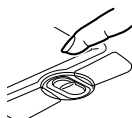

To return, push this forward.
To advance, push this backward.

To scroll a window, click anywhere in the window and push the scroll button forward or backward to scroll the window.

(Your computer or situation may not look exactly like this illustration.)

Critical Points

- ◆ You can change the functions assigned to the right and left buttons and also adjust the mouse speed, using the Mouse Properties dialog box. To display this dialog box, click the Printers and other hardware icon in the Control Panel window and select Mouse.
- ◆ When tapping the touch-pad, tap it quickly with the tip of a finger but not strongly.
- ◆ The mouse pointer moves in the same direction as you slide a finger on the touch-pad. If the finger reaches one edge of the pad before you move the pointer to the desired location, move the finger off the pad temporarily, put it in an adequate place on the pad and start sliding the finger again.

Using the scrolling function

The scroll button enables you to easily scroll a window.

1. Click any place in the area (of the window) that you want to scroll.

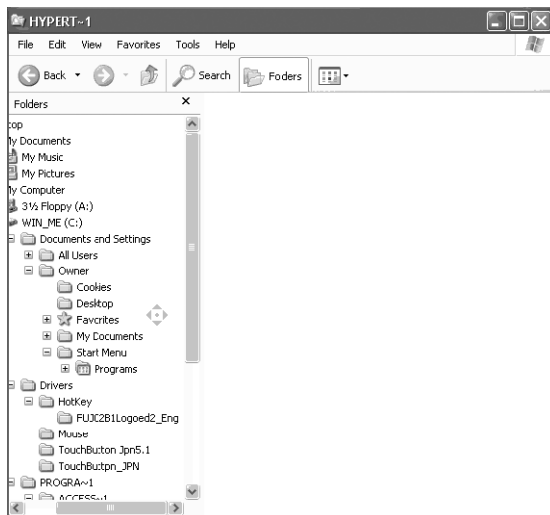

(The illustration varies depending on the model and use conditions.)

2. Move the scroll button forward and backward.

The window scrolls in the same direction you moves the button.

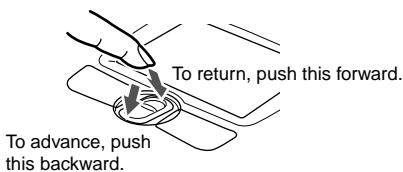

4 Keyboard

Keyboard

□ Names and functions of the principal keys

Keys that can be used as ten-keys

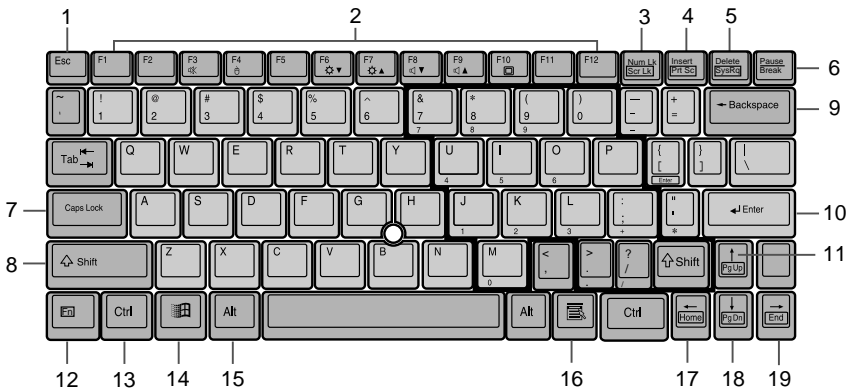

(Your computer or situation may not look exactly like this illustration.)

1. Esc (Escape) key

Used to cancel the current task and return to the previous task.

2. Function keys

Functions assigned to these keys vary from application to application.

3. Num Lk (Numerical Lock) key

Pressing the [Num Lk] key activates the ten-key mode. To deactivate the ten-key mode, press it once again.

4. Insert / Prt Sc (Print Screen) key

- Insert key
Used to specify whether to overwrite an existing string or to insert a new string.
- Prt Sc (Print Screen) key
Used to save the currently displayed windows as pictorial data (bitmap file). To do so, press the [Insert] key while holding the [Fn] key down.
To save only the active window as pictorial data, press the [Insert] key while holding the [Alt] and [Fn] keys down.
Using painting software (e.g., Paint), you can edit, save, and print pictorial data. To do so, you need to import it to the painting software by selecting the Paste command from the Edit menu.

5. Delete key

Used to delete the character on the right of the cursor. With this key, you can also delete the file or icon you selected.

By pressing the [Delete] key while holding the [Ctrl] and [Alt] keys down, you can forcibly terminate the out-of-control application or computer.

6. Pause / Break key

- Pause key
Press this key to pause the screen display.
- Break
Its function depends on the application software.

7. Caps Lock key

To use Capital mode, press the [CapsLock] key.
To deactivate the English Capital mode, press these key again.

8. Shift key

Used in combination with other keys. By pressing a key while holding the [Shift] key down, you can enter the character or symbol printed in the upper case of the key.

9. Back Space key

Used to delete the character on the left of the cursor.

10. Enter key

Used to confirm the string entered.
In text processing, pressing this key inserts a hard return in the text. That's why this key is also called the Return key.

11. Pg Up (Page Up) key/Cursor keys

Used to return to the previous page. To do so, press the [↑] key while holding the [Fn] key down.
Used to move the cursor upward, downward, to right and left.

12. FUNCTION KEYS

Your LifeBook notebook has 12 function keys, F1 through F12. The functions assigned to these keys differ for each application.

The [FN] key provides extended functions for the notebook and is always used in conjunction with another key.

- [FN+F3]: Pressing [F3] while holding [FN] will toggle the Audio Mute on and off.
- [FN+F4]: Pressing [F4] while holding [FN] will toggle the Quick Point feature on and off. Note that the [FN+F4] combination only works if Manual Setting is selected in the BIOS.
- [FN+F6]: Pressing [F6] repeatedly while holding [FN] will lower the brightness of your display.*
- [FN+F7]: Pressing [F7] repeatedly while holding [FN] will increase the brightness of the display.*
- [FN+F8]: Pressing [F8] repeatedly while holding [FN] will decrease the volume of your LifeBook notebook.**
- [FN+F9]: Pressing [F9] repeatedly while holding [FN] will increase the volume of your LifeBook notebook.**
- [FN+F10]: Pressing [F10] while holding [FN] allows you to change your selection of where to send your display video. Each time you press the combination of keys you will step to the next choice. The choices, in order, are: built-in display panel only, both built-in display panel and external monitor or external monitor only.

* There are eight brightness levels.

** There are 26 audio levels.

13. Ctrl key

Used in combination with other keys.

14. Windows key

Used to open the Start menu.

15. Alt key

Used in combination with other keys.

16. Application key

Used to open the pop-up menu for the item selected.

This key has the same function as the right button of the Flat Point.





17. Home key/Cursor keys

Used to move the cursor to the beginning of the line on which it is currently placed. To do so, press the [↵] key while holding the [Fn] key down. Pressing the [↵] key while holding the [Ctrl] and [Fn] keys down causes the cursor to move to the beginning of the text.

18. Pg Dn (Page Down) key/Cursor keys



Used to display the next page. To do so, press the [↓] key while holding the [Fn] key down. Used to move the cursor upward, downward, to right and left.

19. End key/Cursor keys

Used to move the cursor to the end of the line on which it is currently placed. To do so, press the  key while holding the  key down. Pressing the  key while holding the  and  keys down causes the cursor to move to the end of the text.

Used to move the cursor upward, downward, to right and left.

About the ten-key mode

The ten-key mode refers to the mode that enables you to use certain character entry keys as ten-keys (a key arrangement that makes it easy to type in figures). To activate the ten-key mode, simply press the  key. In the ten-key mode,  is displayed on the status indicator LCD. The figure you can enter with a ten-key is marked on the front surface of the key. Note that connecting an optional ten-key pad disables the ten keys on your computer.

5 Changing the Internal Battery Pack

WARNING

ELECTRIC SHOCK



- Before changing the internal battery pack, be sure to turn off your computer and disconnect the AC adapter from it. To avoid shock hazards and damage to your computer, be careful not to touch internal components of the computer, including the battery connector.

RELATED ITEM

- You can install add-on internal battery packs to the mobile multi-purpose bay

Changing the internal battery pack

1. Turn off the computer and disconnect the AC adapter from it.
2. Close the LCD panel, and place your computer upside down.

IMPORTANT

- Close the LCD panel gently to avoid damage due to shock. Failure to do so could result in damage to the LCD panel.
3. Remove the battery pack while pressing the lugs in the direction of the arrow.
The internal battery pack is disengaged from the connector.

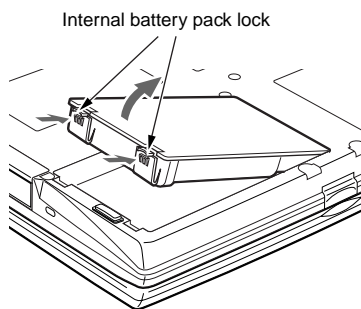

(Your computer or situation may not look exactly like this illustration.)

4. Install a new battery pack.

With the slits in the battery pack aligned with the projections on the computer, place the battery pack in the battery bay and push it down until it clicks into place.

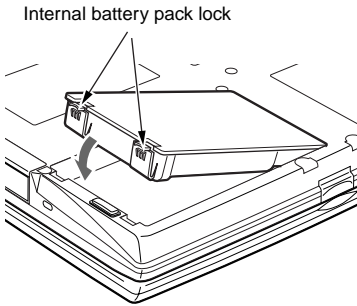

(Your computer or situation may not look exactly like this illustration.)

IMPORTANT

- After removing the internal battery pack, take measures to prevent it from shorting, for example, sealing its connector with an insulating tape. After removing the battery pack, do not mix it with other batteries.

The internal battery pack (lithium-ion battery) contains precious resources. Therefore, you should dispose of the disused battery pack as a recyclable material whenever possible.

6 Running the computer on its battery

❑ Recharging the battery

1. Connect the AC adapter to your computer.

When you connect the AC adapter to your computer, the AC adapter automatically starts to charge the internal battery pack, and the charging status indicator (➡) and the battery life remaining at that time are displayed on the operating status indicator LCD.

2. After the charging status indicator has gone off, disconnect the AC adapter from your computer.

Critical Points

- ◆ Recharge the supplied battery pack prior to first using it after purchase or if it is not recharged for more than one month.
- ◆ Once the battery has been fully charged, the charging status indicator goes off and the battery life indicator at the left end stops blinking (→■■■■) and goes on (■■■■). Allow sufficient time for the battery to be fully charged.
- ◆ When the battery is 90% or more charged, it cannot be recharged even if the AC adapter is connected. The battery can be recharged when its remaining life is 89% or less.
- ◆ When your computer is turned off, all indicators on the operating status indicator LCD will go off automatically soon after the charging of the internal battery pack has been completed.
- ◆ The chargeability of the battery degrades when it is used in an extremely hot or cold place.
- ◆ When the battery is very hot, for example, immediately after the use of the computer, the battery protection function may be activated to prevent the battery from being recharged. (The charging status indicator blinks.) In such a case, stop charging the battery and wait for a while until the battery temperature comes down.
- ◆ When an add-on battery unit is connected, it is charged along with the internal battery pack.

❑ Running the computer on its battery

To run your computer on its internal battery pack, perform these steps.

1. Disconnect the AC adapter from your computer and press the power button.

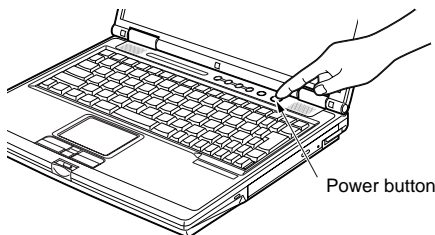

(Your computer or situation may not look exactly like this illustration.)

Critical Points

- ◆ The battery runs down in a relatively short time when it is used in a cold place.
- ◆ The chargeability of the battery degrades over time and its life shortens accordingly after it has been used over an extended period of time. If the battery goes dead soon, replace it with a new battery.
- ◆ When an add-on battery unit is connected, it is charged along with the internal battery pack.

□ Checking the remaining battery life

The remaining battery life is displayed on the operating status indicator LCD when the battery is being charged or your computer is turned on.

Indication of the remaining battery life

 The remaining battery life is approximately between 100% and 76%.



 The remaining battery life is approximately between 75% and 51%.



 The remaining battery life is approximately between 50% and 26%.



 The remaining battery life is approximately between 25% and 13%. (During charging, it indicates that the remaining battery life is approximately between 0% and 25%.)



 Indicates that the battery is weak (remaining life: 12% or less).  blinks.



 Indicates that the battery is completely exhausted (remaining life: 0%).

Critical Points

- ◆ For reasons of lithium-ion battery properties, the battery life indicator may not correctly indicate the remaining battery life under some circumstances (temperature conditions, number of times the battery has been recharged, and so on).
- ◆ When the battery is still 90% or more charged, it cannot be recharged even if you connect the AC adapter to your computer. The battery can be recharged when its remaining life is 89% or less.
- ◆ The number 1 in the battery life indicator (#) denotes the internal battery pack.

Indication of a battery problem

 Indicates that the battery cannot be charged for some reason or other.

Critical Points

- ◆ If  is displayed, turn off your computer, remove and install the battery all over again. If this persists, you might have to replace the battery pack with a new one because it is most likely defective.

❑ Low battery condition

When the battery is discharged to a critically low level, the battery life indicator on the operating status indicator LCD blinks (). If it blinks, connect the AC adapter to your computer to recharge the battery.

Critical Points

- ◆ The use of a weak battery could result in the lost of data you are currently working with or saving. When the battery runs low, connect the AC adapter to your computer as soon as possible, or if no AC adapter is available, immediately save the data you are working with, exit all programs and turn off your computer.
- ◆ Reading or writing data on the hard disk requires a large amount of electrical power. Therefore, when the battery is weak, connect the AC adapter to your computer before reading or writing data on the hard disk.
- ◆ Leaving the battery weak for a certain period of time causes the computer to automatically go into standby mode. When data is being read or written on the hard disk, however, the computer will not go into standby mode before the data reading or writing process is complete.
- ◆ By default, your computer is set so that it will go into standby mode when the battery life reaches about 3%.

❑ Cautions in using the battery pack

WARNING

ELECTRIC SHOCK



- The battery pack is shock-sensitive. To avoid damage due to shock, be careful not to drop the battery pack when installing or removing it. For safety's sake, do not use a battery once it has been shocked. The use of a damaged battery could result in an electric shock or explosion.

- **Do not take the battery apart.**
Taking the battery apart or touching its internal components could result in an electric shock or fire.
- **Electrical discharge**
 - It is good practice to always recharge the battery before use since it is discharged spontaneously.
 - When you know you will not use the computer for a long period of time (for one month or more), remove the battery pack from your computer and keep it in a cool place. Leaving the battery in the computer without recharging for a long period of time causes it to be discharged excessively and shortens its useful life.
- **Useful life of the battery**
 - The battery runs down and deteriorates over time even if it is not used. To check the battery condition, therefore, you should run your computer on its internal battery at least once a month.
 - Leaving the battery in a hot place causes it to go dead and deteriorate in a short time.
 - The battery pack is consumable and its chargeability degrades gradually over time. When the battery has reached the end of its useful life, replace it with a new one.
 - When the battery is approaching the end of its useful life, it goes dead in a very short time.
 - When the battery has reached the end of its useful life, remove it from the computer. Leaving it in the computer could result in an electric shock or fire.
- **Disposal of the battery pack**
 - Before disposing of the battery pack, take measures to prevent it from shorting, for example, sealing its connector with an insulating tape. After removing the internal battery pack, do not mix it with other batteries.
The internal battery pack (lithium-ion battery) contains precious resources. Therefore, you should dispose of the disused battery pack as a recyclable material whenever possible.
- **Battery life**
 - The energy-saving features of your computer help you conserve battery power.
 - Battery life greatly varies according to the ambient temperature.
- **You should power your computer from the AC adapter when:**
 - Connecting to Online Service or the Internet for a long time,
 - Using the hard disk or DVD/CD drive frequently,
 - Connecting to a LAN,
 - Restoring the computer to its original state,
- **When connecting to Online Service or the Internet**
Connecting to Online Service or the Internet requires a large amount of electrical power. So you should check the remaining life of the battery from time to time during communications.

7 Using a LAN

IMPORTANT

- Items you need to set up, such as TCP/IP, for network connections, vary depending on which type of network you want to use: wired LAN or wireless LAN. Set up your computer according to the situation in which you will use your network.

Using a wired LAN

□ Preparing necessary items

LAN cable	There are two types of LAN cables: straight type and cross type. Select a cable appropriate to the data transfer rate of the network you want to use.
Network connection device	Prepare a device that serves your purpose of connecting to a LAN. Here are some examples of network connection devices. <ul style="list-style-type: none">• Cable modem• ADSL modem• Hub
Instruction manual for network connection device	Methods of connection vary among network connection devices.

❑ Connecting a LAN cable

⚠ WARNING

ELECTRIC SHOCK



- Before connecting a LAN cable to your computer, always turn off the computer and disconnect the AC adapter from it to avoid shock hazards.
- When it thunders, turn off the computer and disconnect the AC adapter and the LAN cable from it as soon as possible. Failure to do so could result in damage to your computer or a fire due to a thunderbolt.

⚠ CAUTION

ELECTRIC SHOCK



- Do not put your finger into the LAN port, or you might get an electric shock.

BREAKAGE



- To avoid damage to your computer, do not plug a LAN cable in any port other than the LAN port.

1. Turn off the computer and disconnect the AC adapter from it.
2. Plug a LAN cable in the LAN port on the back of the computer.

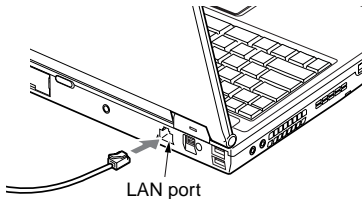

3. **Connect the LAN cable to the network connection device.**
Plug the other end of the cable connected in step 2 in the port on the network connection device, and turn on the network connection device.
4. **Connect the AC adapter to the computer and turn on the computer.**
5. **Click the Start button and select Control Panel.**
6. **Click Performance and Maintenance, then Power Options.**
7. **On the Power Schemes page, set the items below, and click OK when you are through.**
 - System standby: Never
 - System hibernates: NeverThese settings prevent Windows from automatically placing your computer into standby or hibernation mode.

When you are through with this process, set up a network connection.

❑ Setting up network connections

IMPORTANT

- If you have already set up wireless LAN connections, set up network connections with care so that they will not conflict with the wireless LAN connections already set up. A conflict between a wireless LAN connection and a wired LAN connection prevents your computer to carry out communications over your LAN.
- When you are connected to a network (such as the Internet), do not place your computer into standby or hibernation mode, otherwise your computer may not maintain connection with the network.
Whenever your computer is not in use, it should be turned off.
- If you disconnected the LAN cable after placing your computer into hibernation mode while leaving it connected to the LAN, be sure to connect the AC adapter to your computer before resuming operation. Failure to do so may cause your computer to malfunction.
- By default, your computer is configured so that turning on your computer will not automatically make the wired LAN features ready for use, except when a LAN cable and the AC adapter is connected to it. To make the wired LAN features ready for use, shut down your computer, connect a LAN cable and the AC adapter to it, and then turn your computer back on.
- If you want to keep the wired LAN features always ready for use, modify the settings of BIOS Setup.
- When you want to connect to an existing network, ask the network administrator what and how you should set up.
- If you want to use an ADSL to connect to the Internet through your network, set up your computer for network connections, following the instructions from your ISP (Internet service provider) or communications line provider.

Critical Points

- ◆ By default, your computer is configured so that it will check whether a LAN cable is connected or not, each time you turn it on or restart it when it is powered from its internal battery.
If no LAN cable is connected at that time, the built-in LAN device will be disabled for energy saving.
Whenever you want to use the built-in LAN device, connect a LAN cable or the AC adapter to your computer before turning on or restarting your computer.
If you want to keep the built-in LAN device always ready for use, disable the energy-saving features by modifying the settings of BIOS Setup.
- When disconnecting the LAN cable from your computer, pull out the connector while holding down the stopper on it, otherwise the connector could be broken.
- When connecting to a LAN, you should power your computer from the AC adapter whenever possible, since data transfer over a network requires a large amount of electrical power.

8 About the built-in Modem

⚠ CAUTION

ELECTRIC SHOCK



- To avoid shock hazards, do not put your finger into a phone jack (for modular cables) on the wall.

⚠ CAUTION

BREAKAGE



- To avoid damage to your computer, do not plug a modular cable in any port other than the modem port.

☐ Plugging in a modular cable

1. **Plug the supplied modular cable in the modem port on the left-hand side of your computer.** Insert the connector until it clicks into place.

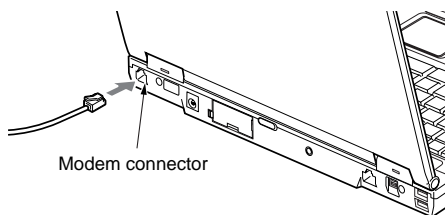

(Your computer or situation may not look exactly like this illustration.)

2. **Unplug the telephone's modular cable from the phone jack on the wall.**

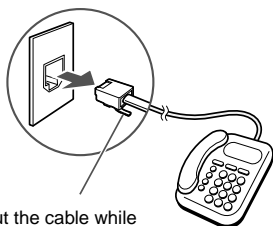

Pull out the cable while holding down the stopper.

IMPORTANT

- If a rosette type phone jack is used, it needs be changed to a modular type.
Changing a phone jack from rosette type to modular type must be done by an authorized technician or under his or her supervision. So, if you need to change the phone jack, you will have to ask your local Telephone system office or branch. (Please check with your local Telephone system)

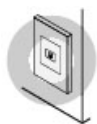

Modular type

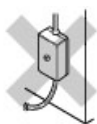

Rosette type

3. Plug the modular cable from your computer in the phone jack on the wall.

Insert the other end of the modular cable from your computer into the modular type phone jack.

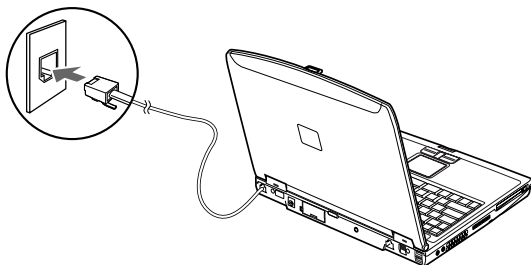

(Your computer or situation may not look exactly like this illustration.)

Critical Points

- ◆ Your telephone cannot be used when its modular cable is disconnected. So, do not forget to plug it again after using the built-in modem.
- ◆ If you run the modular cable close to a household electrical appliance or tie it in a bundle, a communications error could occur.
- ◆ If the supplied modular cable is too short to connect your computer to the phone jack on the wall, use a commercially available modular cable instead. Note that the use of a long modular cable could result in a reduction in the data transfer rate or a communication error.

IMPORTANT

- If you navigate the Internet for a long time while leaving programs active, a heavy load is applied to the CPU of your computer and communications via the built-in modem may be broken unexpectedly. If this happens, exit all running programs other than the Web browser and e-mail program before connecting to the Internet again.

9 LifeBook Security/Application Panel

LifeBook Security / Application Panel

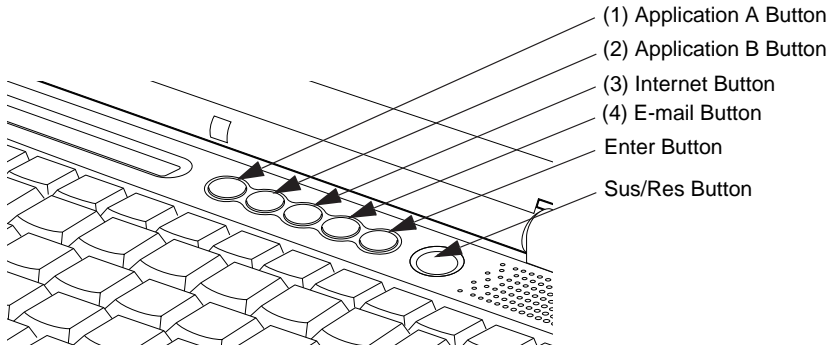

(Your computer or situation may not look exactly like this illustration.)

A unique feature of your LifeBook is the Security/Application Panel that allows you to secure your LifeBook from unauthorized use. The Security/Application Panel also allows you to launch applications with a touch of a button when your system is on. If the security system is activated, upon starting your LifeBook or resuming from suspend mode the security system requires you to enter a password code using the buttons on the Security/Application Panel. After entering a correct password, your LifeBook resumes system operation. (Refer diagram above)

Setting up your LifeBook Security Panel

Numbered Buttons

Use these buttons to enter your password. (Refer diagram above)

Enter Button

After entering the button strokes, push this button to enter the password into the LifeBook. (Refer diagram above)

Passwords

The user and supervisor password may be set on this LifeBook. A supervisor password is typically the same for all LifeBooks in a working group, office, or company to allow for system management. Individual LifeBooks in a group environment should not use a common password. A password consists of one to five button strokes plus the enter button. A valid stroke consists of pushing one or up to four buttons simultaneously. The following are valid button strokes:

- Pushing [4] by itself
- Pushing [2] and [3] at the same time
- Pushing [1], [2], and [4] at the same time
- Pushing [1], [2], [3], and [4] at the same time

The following are valid passwords. The numbers within braces ({ }) are button strokes using more than one button.

- {[2]+[3]}, [1], [enter]
- [4], [enter]
- {[1]+[3]}, {[2]+[3]+[4]}, [1], [4], [2], [enter]

❑ Setting Passwords

When shipped from the factory, no passwords are set. You have a choice of having no password or setting a supervisor and user password. You must set the supervisor password before the user password.

Critical Points

- ◆ The purpose of supervisor password is to be able to bypass the user password in case the user password is forgotten. The supervisor password alone will not lock the system.
- ◆ You have to set both the supervisor and user passwords for the security panel to work.

❑ Setting Supervisor Password

You must have set a supervisor password before setting any user passwords. The supervisor password can bypass the user password.

1. Go to the **Start** menu.
2. Click on **Run**.
3. Type in FJSECS.EXE, then press [Enter]
4. Follow the on-screen instructions to set the Supervisor password.

❑ Setting User Password

1. Go to the **Start** menu.
2. Click on **Programs**.
3. Click on **Security Panel Application** and **Set User Password**.
4. Follow the on-screen instructions to set the User password.

Critical Points

- ◆ You may change or remove the supervisor or user password by repeating the steps defined above.

Operating your LifeBook Security/Application Panel

The security lock feature is in effect both when the system resumes from Off or suspend state. You always need to push the Suspend/Resume button to input the user password. Your system will not begin the boot sequence without entering your supervisor/user password.

❑ From Off State

1. Turn on your system.
2. When the Security Indicator flashes, enter the password and press Enter button. For example, if the password is 22222, Press Button Number 2 five times and press Enter button. The LifeBook will boot to normal operation.

❑ From Suspend State

1. Press your Suspend/Resume button.
2. When the Security Indicator flashes, enter the password and press Enter button. The LifeBook should resume normal operation.

❑ Incorrect Password Entry

If an invalid supervisor or user password is entered three times in succession, the system will “beep” for about one minute. If a valid password is entered within a minute (while system beeps), the beeping will stop and the LifeBook will resume normal operation. If no or an invalid password is entered while the system beeps, the system will return to its previous locked state (suspend or off) and the Security Indicator will go off. To reactivate the LifeBook after a password failure, you must press the Suspend/Resume button, then enter a correct password.

Critical Points

- ◆ Remember the user password you specified on the Security Panel Application. If you forget the password you will not be able to use your computer. The supervisor password can override the user password.

Precautions

❑ Opening and Closing the Cover

Closing the cover automatically places the LifeBook into suspend mode. Opening the cover does not automatically place the LifeBook into normal operation. Instead, you must enter the proper security password after pushing the Suspend/Resume button.

❑ Low Battery Operations

If your LifeBook has low battery, pushing the suspend/ resume button only turns on the Security Indicator. Your LifeBook does not unlock, the Security Indicator turns off after one minute. To resume normal operation, first attach a power supply to the LifeBook. Then you may unlock the LifeBook.

Uninstalling the security Panel Application

You have two options when uninstalling the security panel application:

- Uninstall the security panel application software. This will disable all security feature.
- Uninstall the security panel application with password still active. This will not allow any changes to the password.

❑ Uninstalling the Security Panel Application Software

Remove passwords when User wants no password protection whatsoever and doesn't want to give anybody the utility to set a password on their computer. In this case, if passwords (supervisor, user, or both) are set, the passwords must first be cleared BEFORE removing the application. To clear passwords, follow same procedure in SETTING PASSWORD CODES except this time, select REMOVE, enter current password then click **Next**. When asked to confirm select **Yes**.

❑ Removing Security Panel Application With Password still Active

Using this feature will not allow any changes to the password.

Critical Points

- ◆ Removing the applications does not remove the password. It simply removes the utility to change/ add/ remove passwords. To change your password you must reinstall the application.

User:

1. Go to Start Menu, Click on **Control Panel**.
2. Open **Add/Remove Programs Properties** in the Control Panel.
3. Select the **Security Panel Application** in the list, and click **Add/Remove**.
4. When the Confirm File Deletion box appears, click **Yes**.

Supervisor:

1. Go to **Start** Menu, Click on **Control Panel**.
2. Open **Add/Remove Programs Properties** in the Control Panel.
3. Select the **Security Panel Application for Supervisor** in the list, and click **Add/Remove**.
4. When the Confirm File Deletion box appears, click **Yes**.

Reinstalling the Security/Application Panel

To reinstall supervisor or user security application, you will need your Software Drivers CD where the programs is located at LifeBook_Options\Security Panel. It contains the setup files for supervisor and user security application.

1. Double-click the Setup SETUPS.EXE file. The Installing Security Panel Application window will appear. Follow the instructions on the screen.
2. Double-click the Setup SETUP.EXE file. The Installing Security Panel Application window will appear. Follow the instructions on the screen. Supervisor and user passwords can be set by the Windows Software which are FJSECS.EXE and FJSECU.EXE respectively. FJSECU.EXE for user password cannot run without supervisor password. First you need to run FJSECS.EXE to set supervisor password before setting user password. Follow instructions under Setting Passwords.

The LifeBook Security Panel is designed to prevent theft or unauthorized access to your LifeBook. It is important that you remember the password that has been set in your LifeBook otherwise the LifeBook will not be able to operate or resume from suspend.

The LifeBook Security Panel is a high security feature. Should you forget the password that you have set, you are required to return your LifeBook to:

Fujitsu PC Asia Pacific Pte. Ltd.
238A Thomson Road, #24-01/05
Novena Square Tower A
Singapore 307684

Note: The authorised Fujitsu Service Center will not be able to reset the password. Please remember to keep your password in a safe place.

There is a service charge for unlocking the password restricted LifeBook. You will bear all the cost returning the LifeBook to our service centre to unlock the password.

Email: www.fujitsu-pc-asia.com/contactus

Configuring your LifeBook Application Panel

When you start Windows, the LifeBook Application Panel is automatically activated. As an application launcher, the LifeBook Application Panel is very flexible, giving you a variety of options. To set up the Panel to best suit your needs, we have provided the Application Panel Setup utility that quickly and easily helps you make the most of this valuable feature.

To configure your LifeBook Application Panel with Application Panel Setup:

1. **Click on Start.**
2. **Click on Control Panel.**
3. **Click on Application Panel.**

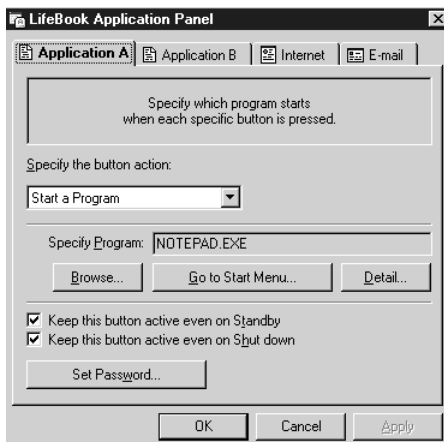

The Application Panel Setup utility will appear. There are tabs that correspond to the application buttons on the LifeBook Application Panel. When you receive your notebook, these buttons are configured to launch specific applications. Below is the example of applications associated with each button.

Label	Button Function	Default Application
1	Application A	Notepad
2	Application B	Calculator
3	Internet	Internet Explorer
4	E-Mail	Outlook Express/*others email application

Critical Points

- ◆ The tabs in Application Panel Setup may not be in the same order as the buttons on your LifeBook notebook. Please carefully select the tab you wish to change.

To change an application associated with the Application A, Application B, or E-mail buttons, click on the tab for the button you would like to reconfigure – for example, Application A. Click on Browse from Start Menu, scroll down the list of applications, click on the application you wish to launch with this button, and then click OK. The button will now launch the new application.

The Internet tab is different. It comes set to launch your default Windows Internet browser, (Internet Explorer, unless changed.) In order to reconfigure it to launch another program follow these easy steps:

1. **Click on Other from the Internet browser box.**
2. **Click on Browse from Start Menu.**
3. **Scroll down the list of applications, and the click on the application you wish to launch with this button.**
4. **Click OK.**

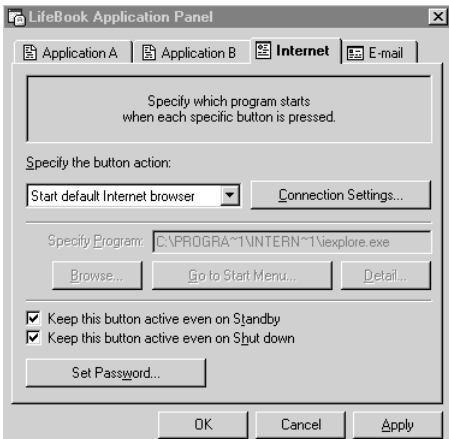

The button will now launch the new application. If you want to return to launching your Windows default Internet browser with this button, you need only click on “Default Internet Browser” from the Internet browser box. Be aware that you will erase the settings for the “other application”. If you wish to go back to launching the “other application” from this button, you will need to reconfigure it as described above.

When you have finished with Application Panel Setup click on OK, and the new settings will take effect. You can reconfigure your LifeBook Application Panel as often as you like.

Critical Points

- ◆ The Internet or E-mail buttons can be configured to launch any application you wish, not just an Internet browser or e-mail program.

Enabling/disabling Application Launcher button (Select Models Only)

At the bottom of each application setup page are two selectable options. The first will “Keep this button active even on Standby”, and the second will “Keep this button active even on Hard Drive Timeout”. You can enable/disable either or both of these functions simply by check or unchecking the check Box.

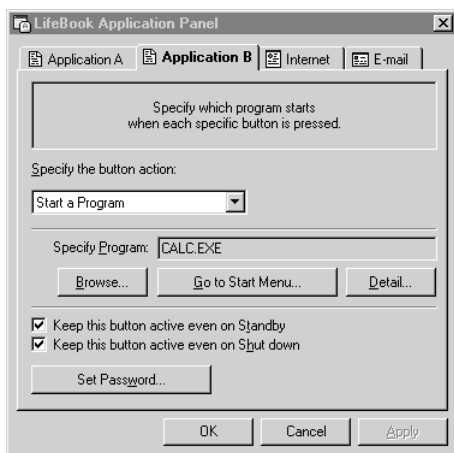

Configure your E-mail Account Settings

Critical Points

- ◆ The E-mail Notification LED is available on select LifeBook notebook models only.
- ◆ To use the E-mail LED notification, you must have access to a POP3 Server with no Security Password Authentication. Contact your service provider to determine if they support POP3 without Security Password Authentication.

Connection

To configure the E-mail Account Settings:

1. Click on Start.
2. Click on Control Panel.
3. Click on Application Panel.
4. Click on the E-Mail tab.
5. Click on E-Mail Account Settings...
6. The E-Mail Setup screen appears. Choose the type of connection: LAN or Dial Up.

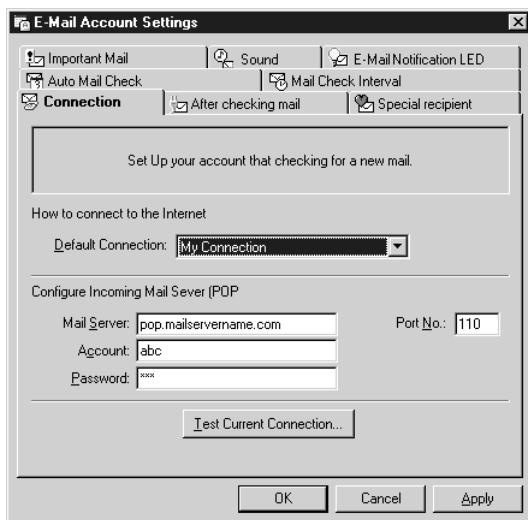

- If LAN: Click on LAN. Enter the POP3 Server name, your account name and password for that account. Consult your Service provider if you do not know or are unsure of the information requested.
- If Dial Up: Click on Dial Up. Choose the Dial up configuration (as previously set in Dial Up Networking) you wish to retrieve mail from. Enter the POP3 Server name, your account name and password for that account. The account name and password should be the same information you entered in the Dial Up configuration. After all the information has been entered, test the connection by clicking on “Testing connection with current setting”. If an error occurs, check the settings and information on Dial Up Network and E-mail LED notification.

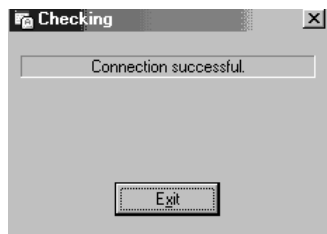

After the setup (Dial Up Networking/E-mail) is completed, you are ready to retrieve mail. When you press the E-mail button, your system will establish connection with your provider, check for and retrieve new mails, terminate the connection.

To configure After checking mail

This setting lets you set your computer to return back to the previous power saving state after checking mail.

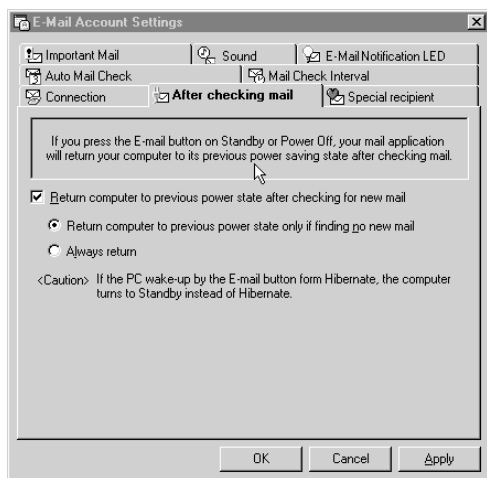

To configure Auto Mail Check

This function allows you to specify day and time for checking new mail. Only applicable when the PC stays Standby.

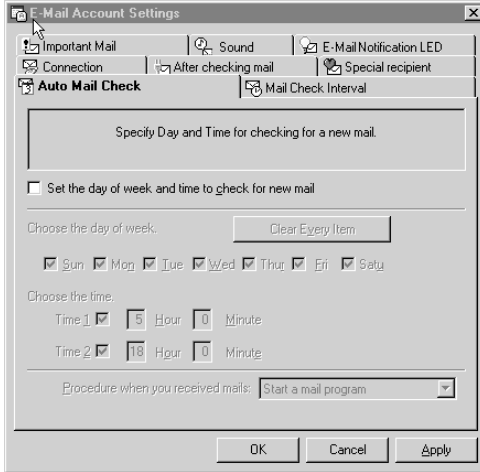

To configure Mail Check Interval

This function allows you to specify an interval (minutes) for checking for a new mail when you are using the computer. Recommendation of this function use with LAN connection.

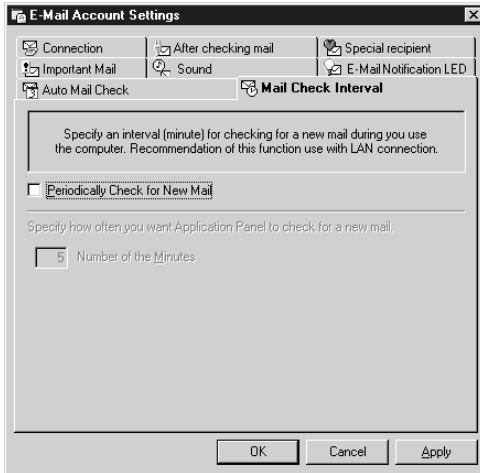

To configure Special recipient

This function allow you to add a special recipient on the Address List.

You have to specify from the Mail Check Interval to check the check box of Periodically check for New Mail from the menu Mail Check Interval.

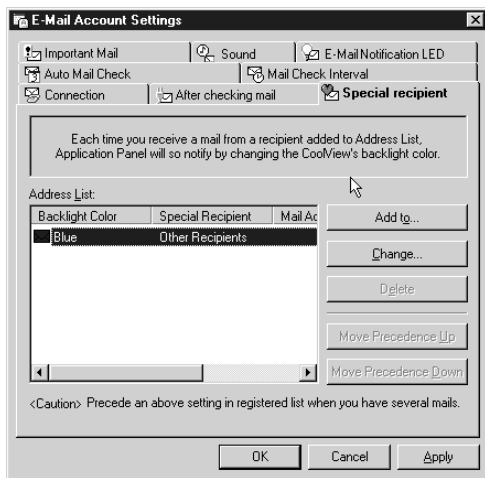

There is an icon that looks like an envelope which appears on the taskbar when you receive an email from the special recipients that you have configured.



To configure Important Mail (Only applicable for CoolView Panel model)

This function allow you to change the icon color on the taskbar to notifies you that an important mail comes.



To configure Sound

This allows you to change the LifeBook Application icon's color on the taskbar and beeps each time you receive a new message.

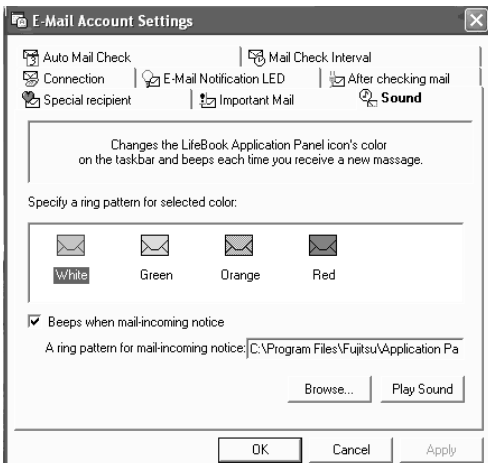

Desktop Control Panel

Your LifeBook notebook includes a CD Player control panel. You may use this panel to operate the Disc Player.

To use the desktop control panel:

1. Click on **Start**.
2. Click on **All Programs**.
3. Click on **LifeBook Application Panel**.
4. Click on **Display CD Player**.

The CD Player will appear in the upper left corner of your screen.

To close the panel, click on the "x" button. To minimize the panel, click on the "-" button.



You can select from four appearances for your CD Player. Simply double click on the track display area of the panel, and a menu will appear which will allow you to select from a pull down menu. On the CD Players Options menu box, you have an options to select : Always on top, Continuous play and Disable Stop/Eject Button from the CD removal. If you click on "Always on top" the desktop controls will always be seen on your screen, no matter what other application you are running. If you click on "Continuous Play", your Disc Player will automatically start over at the beginning as soon as it finishes the last track. By default the Eject Button is disable from the CD Player Options. Once you click the Eject button from the CD Player, the drive will not eject. If you want the Eject Button to be function, uncheck this options.

You can change the CD Player design by selecting the setting from the pull down menu from the CD Player options.



Grey (High Color)

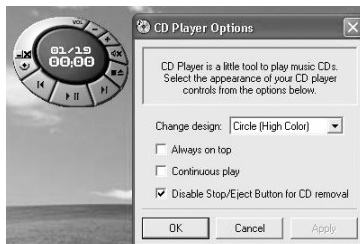

Circle (High Color)



Stick (High Color)

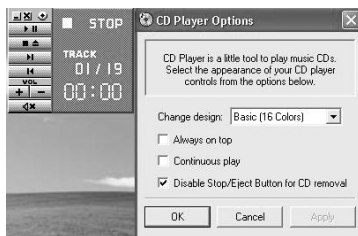

Basic (16 colors)

You can move the CD Player to anywhere on your desktop. Drag it by clicking on the track number display, holding it down, and dragging the control panel.

When you have placed it where you would like, release the mouse button.

Critical Points

- ◆ If you have your display set to 256K colors the basic display will appear no matter which one you select. You will need to set your colors, the basic colors to more than 256K in order to select other display appearances.
- ◆ When you close the Disc Player's desktop control panel, it will stop the audio Disc Player.

Precautions

- LifeBook Application Panel uses the date and time settings of your LifeBook notebook. If the date and time are off, you can adjust this setting in the Windows Control Panel.
- If you insert an audio CD which has both audio and data tracks into the Disc Player, the Disc Player may fail to play the first audio track.
- The Volume Up, Volume Down and Mute controls for the Disc Player desktop control panel adjust the volume of the CD audio line only. It does not adjust your notebook's master software volume control or the manual volume on the LifeBook notebook.
- The Disc Player desktop control panel is designed to be displayed in High Color (16-bit) or in True Color (24-bit or more). If you have your notebook's display set for 256 colors or less, the Disc Player control panel will display in a "basic" mode.

10 Wireless LAN Function (For selected model)

Preface

Thank you for purchasing the Fujitsu LifeBook.

This document describes the setup of this personal computer for using the Wireless LAN compliant with IEEE802.11b.

Before starting up this personal computer, read this document and operate the computer properly.

Notice to the User

■ **Wireless interoperability**

This personal computer is designed so that it achieves the collaboration of an intercommunications system with Wireless LAN products based on the wireless LAN technology of the Direct Sequence Spread Spectrum (DD-SS) scheme. This personal computer also complies with the Wireless LAN Standard “Wi-Fi” defined by the “Wi-Fi Alliance” which verifies interconnectability between Wireless LAN products.

■ **Effects of radio-wave radiation on environments**

- As with other high-frequency units, this personal computer emits high-frequency energy. The level of the energy emitted from this personal computer is controlled well below the electromagnetic energy emitted from, for example, a cellular phone or other wireless devices or units.
- Since it operates within high-frequency safety standards and officially recommended guidelines, this personal computer ensures safety for the user. These standards and recommendations incorporate the unified view of the scientific world and are based on the deliberations of research teams and on the rules and conventions established at the commissions consisting of scientists who scan and interpret the contents of extensive research bibliography on a continual basis.
- Under specific circumstances and environments, the use of this personal computer may be limited by the owners of buildings and the responsible representative persons of organizations. An example of the specific circumstances and environments referred to here is shown below.
 - Use under the environment where there is the danger of interference with other units, devices, or services.
- If you are not sure about the guidelines applied to the use of wireless units or devices in a specific organization or environment (such as an airport), before turning on the power of this personal computer, please contact the corresponding organization or building owner and confirm whether it is necessary to obtain permission for the use of the computer.

■ **Effects of radio-wave radiation on the human body**

The output power radiated from this personal computer is suppressed well below the radio-wave radiation limit specified by FCC. Nevertheless, this personal computer must be used so that the voltage applied will be minimized with respect to human contact under normal operating conditions. During the use of the computer, touching its antenna must be avoided as far as possible. For the antenna, refer to the “NAMES OF COMPONENTS” section of the relevant manual accompanying the main unit of the personal computer.

■ Precautions on interference

- This personal computer generates, uses, and radiates high-frequency energy.
- If this personal computer is not set up or used in accordance with this document, harmful interference may be caused to wireless communications.
- If this personal computer causes harmful interference to radio or television receivers (whether this is actually happening can be identified by powering on and off the computer), use either of the following methods to remove the cause of the interference:
 - Extend the distance between the main unit of the computer and the radio or television receiver.
 - Connect the main unit of the computer to either outlet of a power circuit separate from that of the outlet to which the receiver is connected.
 - Consult with a qualified and experienced radio/television electrical engineer.
- Do not modify this personal computer improperly.
- The manufacturer does not bear responsibility for interference with the radio or the television due to improper modification of this personal computer.
- Other wireless equipment may be using the same frequency as that of this personal computer. Strictly observe the following precautions as well in order to avoid electromagnetic interference with other wireless equipment:

Precautions on interference

2.4DS4



- The wireless equipment bearing the label shown above operates at 2.4 GHz. This type of equipment employs the modulation scheme called “DS-SS”, and its interference distance is 40 meters.
- Not only microwave ovens and other industrial, scientific, and/or medical equipment, but also the local wireless stations used in plants, manufacturing lines, etc. to identify mobile bodies (the use of these wireless stations requires a license) and specified low-power wireless stations (the use of these wireless stations does not require a license) are placed in operation in the operating frequency band of this product.
 1. Before using this product, make sure that local wireless stations for the identification of mobile bodies or specified low-power wireless stations are not in operation nearby.
 2. If electromagnetic interference with any local wireless stations for the identification of mobile bodies is caused by the use of this product, immediately stop the emission of the radio waves.

Representation of Symbols and Others in this Document

■ About examples of display and illustrations

The screen display modes and illustrations shown in this document are examples. The screen modes, illustrations, file names, and others that will be actually displayed may differ according to the particular model of your personal computer.

■ Symbols and others used in text

The meanings of the symbols used in text are listed below.

Symbol with/without word	Meaning
Critical Points	Denotes operating precautions or the acts that must not be performed. Be absolutely certain to read this section.
	Denotes items related to operations. Read this section as required.
→	Reference page

■ Product names

The product names appearing in this document are represented in abbreviated form as follows:

Product name	Representation in text	
Microsoft Windows XP Home Edition	Windows XP	Windows
Microsoft Windows XP Professional		
Microsoft Windows 2000 Professional	Windows 2000	Windows

Microsoft and Windows are registered trademarks of the US Microsoft Corporation in the United States of America and other countries.

Other product names are trademarks or registered trademarks of the respective companies.

Other products are copyrighted by the respective companies.

Copyright © FUJITSU LIMITED 2003

All Rights Reserved.

Outline

This section explains features of the wireless LAN function and what you can do using this LAN function.

Features of the wireless LAN function

Some of major features are listed below.

- Since the Wireless LAN function uses a 2.4-GHz low-power communications system, the user does not need to acquire a license related to wireless communications.
- The Direct Sequence Spread Spectrum (DD-SS) scheme is employed that is highly resistant to noise.
- This LAN function complies with “Wi-Fi” and allows wireless communications at a maximum communications speed of 11 Mbps.
- The use of the required network name (SSID) and network key allows accessing by unauthorized persons to be prevented.

Network configuration of the wireless LAN

The use of the wireless LAN function allows connection to any of the following two types of networks:

Ad hoc connection

The network constructed by the personal computers containing the wireless LAN function is referred to as the “ad hoc wireless LAN”, and the connection method used in this case is referred as “ad hoc connection.”

The use of this function allows you to exchange files and share a printer, by selecting the functions, such as “Network Connection”, that the Microsoft network supports.

To use ad hoc connection, it is necessary to enter the same network name (SSID) and the same network key for all the personal computers that are to be connected. If there are any channels to be used for wireless LAN connection, it is also necessary to assign the same data to the channels. Communication is possible, provided that the personal computers to communicate with each other are located within the respective intercommunication service areas. Network connection can be implemented easily and at low costs by using ad hoc connection.

The following illustration shows an example of ad hoc connection:

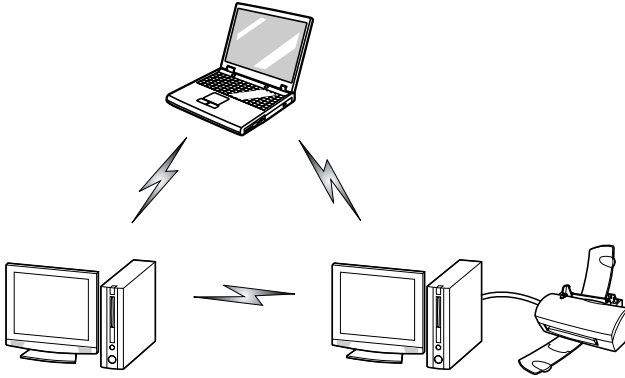

Infrastructure connection

The network that uses one type of hub called the Access Point, such as an optional wireless broadband router, is referred to as the “infrastructure wireless LAN”, and the connection method used in this case is referred to as “infrastructure connection.”

The use of this function allows connection to a wired LAN via a station, and connection to the Broadband Internet.

For details of the Access Point, refer to the manuals accompanying the Access Point.

The following illustration shows an example of infrastructure connection:

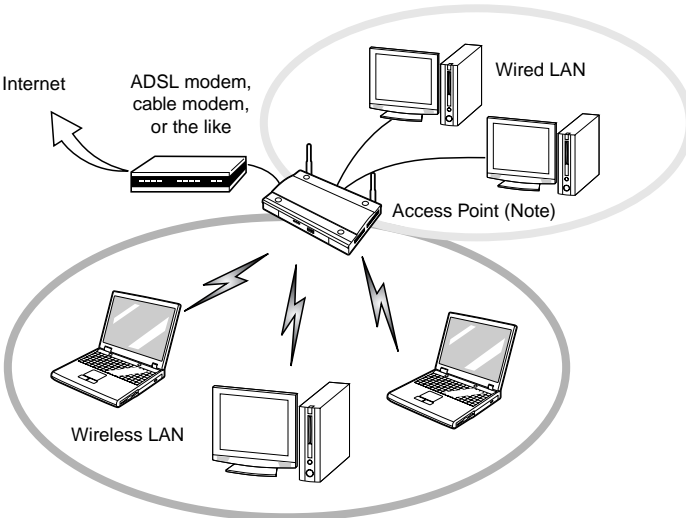

Note:

An optional hub for a wired LAN may be required according to the type of Access Point to be used.

For better communications

Some of major features are listed below.

This personal computer may not operate properly according to the particular operating environment. Strictly observe the following precautions when installing the main unit of the computer:

- Since this personal computer and equipment compliant with IEEE802.11a differ in operation frequency, it is not possible to communicate between both. Be careful of this.
- The recommended wireless communications distance is within a line-of-sight radius of 25 meters. For reasons related to the characteristics of the wireless LAN, however, the actual communications distance depends on the structure or materials type of building in which the wireless LAN function is to be used, the presence/absence of obstructions, the types of software to be used, installation status, radio-wave status, or other operating conditions. Decreases in communications speed or a communications failure may also occur.
- Distance the main unit of this personal computer from other electric appliances. If the main unit of the person computer is installed near a powered-on electric appliance, the computer may not be able to communicate properly or trouble may occur in the electric appliance.

If the computer is unable to communicate properly, change the channel to be used or the installation location. During the use of a microwave oven or other equipment generating strong high-frequency energy, in particular, the personal computer may be highly susceptible to the energy and unable to communicate properly.

- If a broadcasting station or wireless communications equipment is present nearby and this prevents the computer from communicating properly, moving the main unit of the computer is suggested. Radio interference may also occur if the intensity of ambient radio waves is too high.
- About radio interference with the Bluetooth™

Since the Bluetooth™ and the wireless LAN operate at the same frequency (2.4 GHz), if the Bluetooth™ is used near the main unit of this personal computer, radio interference may occur, leading to decreases in communications speed or to a connection failure. If these events actually occur, undertake the following countermeasures:

- Space the Bluetooth™ and the main unit of the personal computer by a distance of at least 10 meters.
- Within a distance of 10 meters, turn off the power of either the Bluetooth™ or the main unit of the personal computer.

Stopping the transmission of radio waves

To use this product in hospitals, clinics, or airplanes, or in other places where the use of electronic equipment is regulated, stop the transmission of radio waves from the wireless LAN.

Deactivation using the wireless switch

The transmission of radio waves from the wireless LAN can be stopped by setting the wireless switch to the OFF position.

For the wireless switch, refer to the "Names of components" section of the relevant manual accompanying the main unit of the personal computer.

Deactivation using your Windows

1. Click the **[Start]** button, **[All Programs]**, **[Intel Network Adapters]**, and **[Intel(R) PROSet]**.
The Intel(R) PROSet window will be displayed.
2. Click the **[General]** tab.
3. Select **[OFF]** for the wireless communications on/off switching function, and then click the **[OK]** button.

Wireless communications on/off switching will be deactivated and the transmission of radio waves from the wireless LAN will be stopped.

Critical Points

- ◆ Select **[ON]** under the deactivated status of the wireless LAN to restart the transmission of radio waves.

Starting the transmission of radio waves

To communicate using the wireless LAN function, set the personal computer to a status in which it can transmit radio waves. Here is the procedure:

1. **Set the wireless switch to the ON position.**
For the wireless switch, refer to the "NAMES OF COMPONENTS" section of the relevant manual accompanying the main unit of the personal computer.
2. Click the **[Start]** button, **[All Programs]**, **[Intel Network Adapters]**, and **[Intel(R) PROSet]**, **in that order.**
The Intel(R) PROSet window will be displayed.
3. Click the **[General]** tab.
4. Select **[ON]** for the wireless communications on/off switching function, and then click the **[OK]** button.

Wireless communications on/off switching will be activated and the transmission of radio waves will be restarted.

Connection Using Windows XP

□ Flow of Operations

The wireless LAN connection procedure is outlined below.

1. **Make sure that the personal computer is ready for the transmission of radio waves from the wireless LAN.**
2. **Assign the parameters required for wireless LAN connection.**
 1. Enter the network name (SSID) and other data.
 2. Enter the network key (the key to be used to encode communications data).
3. **Perform setting operations relating to network connection.**
 1. Specify TCP/IP as the protocol, and confirm the name of the workgroup and other settings.
 2. Enter the data required for file/printer sharing on the network. Perform this operation as required.
 3. For infrastructure connection, enter data for the station.
 4. Verify that you have been able to connect your computer to the network.

Preparation for Wireless LAN Connection

This section explains the preparation (parameter assignment) required for the use of the wireless LAN.

Assigning parameters

Enter the network name (SSID), the network key, and other data required for wireless LAN connection. If there is the administrator of the network, contact the network administrator for data settings.

IMPORTANT

- Wireless channels 1 to 14 are used for the IEEE802.11b-compliant wireless LAN adopted by this personal computer.

Critical Points

- ◆ To use infrastructure connection, refer to the manual of the Access Point for the Access Point-setting procedure.
- ◆ You do not need to set the channel (frequency band). The channel being used for the intended wireless LAN network is detected automatically and your personal computer communicates through that channel. When a new ad hoc wireless LAN network is constructed between the main units of personal computers, channel 11 is preassigned as the default.
- ◆ If it is necessary to change the channel, change the setting of the Access Point. For the setting procedure, refer to the manual of the Access Point. In the case of infrastructure connection, to use ADSL (PPPoE) for accessing the Internet, the MTU size of this personal computer needs to be changed.
For further details, refer to the manual of the Access Point.

1. Click the **[Start]** button first and then **[Control Panel]**.
2. Click **[Network and Internet Connections]**.

Critical Points

- ◆ [Network and Internet Connections] may not be displayed according to the particular environmental conditions or data settings.
3. Click **[Network Connections]**.
A list of currently installed networks will be displayed.

4. **Right-click [Wireless Network Connection] in the list, and then click [Properties] in the menu displayed.**

The [Wireless Network Connection Properties] window will be displayed.

5. **Click the [Wireless Network] tab.**

6. **Make sure that the [Use Windows to configure my wireless network settings] check box is ticked, and click the [Add] button.**

The [Wireless Network Properties] window will be displayed.

7. **Enter the information required for connection to the wireless LAN.**

1. Enter the network name (SSID).

Enter the name of the desired network in less than 32 ASCII characters.

- For ad hoc connection

Assign the same network name to all the personal computers to be connected.

- For infrastructure connection

Assign the appropriate data according to the type of Access Point to be accessed.

For Access Point setting, refer to the manual of the Access Point.

2. For ad hoc connection, tick the next item. For infrastructure connection, clear the tick mark.

- This is a computer-to-computer (ad hoc) network; wireless access points are not used.

8. **Enter the data for encoding communications data.**

IMPORTANT

- It is strongly recommended that you enter the network key for encoding communications data. If the network key is not entered, since the network can be accessed from all personal computers containing the wireless LAN function, there is a danger of your data being stolen or damaged by other users.

1. Tick the [Data encryption (WEP enabled)] check box.

For ad hoc connection, clear the tick mark from the [Network Authentication (Shared mode)] check box.

For infrastructure connection, if the Access Point to be accessed has acquired shared-key authentication, tick the [Network Authentication (Shared mode)] check box.

For open-system authentication, clear the tick mark. For Access Point setting, refer to the manual of the Access Point.

2. Clear the tick mark from the [The key is provided for me automatically] check box.

3. Enter data in [Network Key].

Depending on the number of entered characters or digits, whether the key is an ASCII character code or a hexadecimal code will be identified automatically.

Critical Points

- ◆ Use five or thirteen characters to enter the key in the ASCII character code format. The characters that can be used as the “network key” are as follows:
0 - 9, A - Z, _ (underscore)
 - ◆ Use 10 or 26 characters to enter the key in the hexadecimal character code format. The characters that can be used as the “network key” in this case are as follows:
0 - 9, A - Z, a - f
 - ◆ For ad hoc connection
Assign the same network name to all the personal computers to be connected.
 - ◆ For infrastructure connection
Assign the appropriate data according to the type of Access Point to be accessed.
For Access Point setting, refer to the manual of the Access Point.
4. In [Confirm network key], enter the same data as that of [Network key].
 5. Make sure that [Key index (advanced)] is set to “1”.

Critical Points

- ◆ Any value from “1” to “4” can be assigned to [Key index (advanced)]. Usually, however, assign “1”.
9. **Click the [Authentication] tab and then verify the settings of [Enable network access control using IEEE 802.1X].**
For internal use at an organization such as a company, when access by wireless LAN clients is to be limited using IEEE 802.1x authentication, tick the [Enable authentication for this network IEEE 802.1X] check box.
For home use, clear the tick mark from the [Enable authentication for this network IEEE 802.1X] check box.
For the setting method relating to IEEE 802.1x authentication, refer to the manual of the Access Point which you are using.
 10. **After the setting operations have been completed, click the [OK] button.**
Processing will return to the [Wireless Network Connection Properties] window.
 11. **Verify that the network name entered in step 7 above is added in [Preferred Networks], and then click the [OK] button.**

Critical Points

- ◆ In [Preferred Networks], register only the desired connection settings.
12. **Close the [Network Connection] window.**

Connection to the network

This section explains connection to the network.

If there is the administrator of the network, contact the network administrator for data settings.

Setting the network

Perform the [Setting TCP/IP] and [Computer Name and Workgroup Name] operations required for network connection.

□ Setting TCP/IP

Critical Points

- ◆ To change the setting of the IP address, you need to be logging in from Windows as a user having administrator's authority.

1. Click the [Start] button first and then [Control Panel].

2. Click [Network and Internet Connections].

3. Click [Network Connections].

A list of currently installed networks will be displayed.

4. Right-click [Wireless Network Connections] in the list, and then click [Properties] in the menu displayed.

The [Wireless Network Connection Properties] window will be displayed.

5. Click the [General] tab.

6. Click [Internet Protocol (TCP/IP)] and then click [Properties].

The [Internet Protocol (TCP/IP) Properties] window will be displayed.

7. Set the IP address.

- For ad hoc connection
Select [Use the following IP address] and then enter data in [IP address] and [Subnet mask].
- For infrastructure connection
Select [Obtain an IP address automatically] and [Obtain DNS server address automatically].
Follow the directions if you are directed from the network administrator about IP address setting, DNS server setting, and the default gateway.

8. Click the [OK] button.

Processing will return to the [Wireless Network Connection Properties] window.

9. Click the [OK] or [Close] button.

10. Click the [Close] button in the [Network Connection] window.

☐ Confirming the Computer Name and the Workgroup Name

Critical Points

◆ To modify the computer name and/or the workgroup name, you need to log in from Windows as an administrator.

1. Click the [Start] button first and then [Control Panel].

2. Click [Performance and Maintenance].

3. Double-click the [System] icon.

The [System Properties] window will be displayed.

4. Click the [Computer Name] tab.

5. Confirm the settings of [Computer Name] and [Workgroup name].

- The setting of [computer name] denotes the name for identifying the computer. Any name can be assigned to each personal computer. Enter the desired name in less than 15 ASCII character code format.

Identifiability can be enhanced by entering the model number, the user name, and other factors.

- [Workgroup name] is the group name of the network. Enter the desired name in less than 15 ASCII character code format.

- For ad hoc connection

Assign the same network name to all personal computers existing on the network.

- For infrastructure connection

Assign the name of the workgroup to be accessed.

Critical Points

◆ To change the name, click [Change] and then proceed in accordance with the instruction messages displayed on the screen.

Processing will return to the [System Properties] window.

6. Click the [OK] button.

If a message is displayed that requests you to restart the personal computer, click [Yes] and then restart the computer.

Setting the sharing function

Set the sharing function to make file and/or printer sharing with other network-connected personal computers valid.

The setting operation is not required unless the sharing function is to be used.

The folder and printer for which the sharing function has been set will be usable from any personal computer present on the network.

Critical Points

- ◆ To share a file and/or the connected printer, you need to be logging in from Windows as a user having administrator's authority.

□ Setting the Microsoft network-sharing service

1. Click the [Start] button first and then [Control Panel].
2. Click [Network and Internet Connection].
3. Click [Network Connection].
A list of currently installed networks will be displayed.
4. Right-click [Wireless Network Connection] in the list, and then click [Properties] in the menu displayed.
The [Wireless Network Connection Properties] window will be displayed.
5. If [File and Printer Sharing for Microsoft Networks] is displayed, proceed to step 6.
If [File and Printer Sharing for Microsoft Networks] is not displayed, skip to step 7.
6. Make sure that the [File and Printer Sharing for Microsoft Networks] check box is ticked, and then click the [OK] button.
7. Click [Install].
The [Select Network Component Type] window will be displayed.
8. Click [Service], and then click the [Add] button.
The [Select Network Service] window will be displayed.
9. Click [File and Printer Sharing for Microsoft Networks] and then click the [OK] button.
Processing will return to the [Wireless Network Connection Properties] window, and [File and Printer Sharing for Microsoft Networks] will be added to the list.
10. Click the [Close] button.

❑ Setting the file sharing function

The procedure for setting the file sharing function is laid down below taking the “work” folder within drive C as an example.

1. Click the [Start] button first and then [My Computer].
2. Double-click [Local disk (C:)].
3. Right-click the “work” folder, and then click [Sharing and Security] in the menu displayed.

The [work Properties] window will be displayed.

Critical Points

- ◆ Setting the file sharing function for the file which has been used to execute Network Setup Wizard is suggested on the screen. For the wireless LAN, however, since security is guaranteed by entry of the network name (SSID) and the network key, the steps to be taken to set the file sharing function easily without using Network Setup Wizard are shown below.
4. Click [If you understand the security risks but want to share files without running the wizard, click here].

Critical Points

- ◆ If [If you understand the security risks but want to share files without running the wizard, click here] has already been clicked, this window is not displayed. Skip to step 5.

Details of the [work Properties] display in the [Network sharing and security] window will change.

5. Tick the [Share this folder on the network] check box.

Critical Points

- ◆ To specify the corresponding folder as a read-only folder, clear the tick mark from the [Allow network users to change my files] check box.
6. Click the [OK] button.

The folder will be set as a sharable folder, and the display of the icon for the “work.” folder will change.

❑ Setting the printer sharing function

1. Click the [Start] button , [Control Panel] select [Printers and Other Hardware], select [Printers and Faxes].
A list of connected printers will be displayed.
2. Right-click the printer for which the sharing function is to be set, and then click [Sharing] in the menu displayed.
The Properties window corresponding to the selected printer will be displayed.

Critical Points

- ◆ Setting the printer-sharing function where Network Setup Wizard has been executed is suggested on the screen. For the wireless LAN, however, since security is guaranteed by entry of the network name (SSID) and the network key, the steps to be taken to set the printer-sharing function easily without using Network Setup Wizard are shown below.
3. Click [If you understand the security risks but want to share files without running the wizard, click here].
The [Printers properties] window will be displayed.
 4. Click [Share this printer] and then click the [OK] button.
Control will be returned to the property window corresponding to the selected printer.
 5. Click [Share this printer] and after confirming the name displayed in [Share Name], click the [OK] button.
Printer sharing will be set and the display of the icon for the printer will change.

Confirming connection

After you have finished the network setup operations, access the folder whose sharing has been set for other personal computers. Also, confirm the status of the radio waves in case of trouble such as a network connection failure.

Critical Points

- ◆ In the case of infrastructure connection, enter the necessary data for the Access Point before confirming connection. Refer to the manual of the Access Point for the Access Point setup procedure.

❑ Connecting your personal computer to another personal computer

1. Click [Start] first and then [My Computer].
The window [My Computer] will be displayed.
2. Click [My Network] in the “Others” list.
The window [My Network] will be displayed.
3. Click [Workgroup Computer name] in the list of network tasks.
The computers in your work group will be listed.

4. Double-click the personal computer to which your personal computer is to be connected.
5. Double-click the folder to be accessed.

Confirming the status of the radio waves

The procedure for setting the file-sharing function is laid down below taking the “work” folder within drive C as an example.

1. Click the **[Start]** button, **[All Programs]**, **[Intel Network Adapter]**, and **[Intel(R) PROSet]**, in that order.

The [Intel(R) PROSet] window will be displayed.

2. Click the **[General]** tab and confirm radio-wave status in the window displayed.

The current connection status will be displayed.

- Quality of the signals
The quality of the signals is displayed on a graph.
- Network name (SSID)
The connected network name (SSID) is displayed.
- Profile name
“<No profile>” is displayed.
- Mode
If infrastructure connection is in use, “Infrastructure (Access point)” will be displayed.
If ad hoc connection is in use, “Ad hoc” will be displayed.
- Security
The setting status of WEP is displayed.
- Speed
The communications speed is displayed.
- Band (Frequency)
The current operating frequency band is displayed.
When communication is possible, “802.11b (2.4 GHz)” is displayed.
- Channel
The channel number currently being used for the communications is displayed.

Connection Using Windows 2000

□ Setting TCP/IP

The wireless LAN connection procedure is outlined below.

- 1. Make sure that the personal computer is ready for the transmission of radio waves from the wireless LAN.**
- 2. Assign the parameters required for wireless LAN connection.**
 1. Enter the network name (SSID) and other data.
 2. Enter the network key (the key to be used to encode communications data).
- 3. Perform setting operations relating to network connection.**
 1. Specify TCP/IP as the protocol, and confirm the name of the workgroup and other settings.
 2. Enter the data required for file/printer sharing on the network. Perform this operation as required.
 3. For infrastructure connection, enter data for the Access Point.
Refer to the manual of the Access Point for further details.
 4. Verify that you have been able to connect your computer to the network.

Preparation for Wireless LAN Connection

This section explains the preparation (parameter assignment) required for the use of the wireless LAN.

Assigning parameters

Enter the network name (SSID), the network key, and other data required for wireless LAN connection. If there is the administrator of the network, contact the network administrator for data settings.

IMPORTANT

- Wireless channels 1 to 14 are used for the IEEE802.11b-compliant wireless LAN adopted by this personal computer.

Critical Points

- ◆ To use infrastructure connection, refer to the manual of the Access Point for the Access Point-setting procedure.
- ◆ In the case of infrastructure connection, to use ADSL (PPPoE) for accessing the Internet, the MTU size (see page 50) of this personal computer needs to be changed. For further details, refer to the manual of the Access Point.

1. **Click the [Start] button, [Programs], [Intel Network Adapter], and [Intel(R) PROSet].**

The [Intel(R) PROSet] window will be displayed.

2. **Click the [Network] tab.**

3. **Click the [Add] button.**

The [Profile Wizard] window will be displayed.

4. **Enter the information required for connection to the wireless LAN.**

1. Enter data in [Profile name].

Enter the name of the system file for saving the parameter information that you are going to enter. Enter the desired character string consisting of less than 40 ASCII characters.

Also, multiple [Profile] items can be created covering both ad hoc connection and infrastructure connection. When there are multiple wireless LANs to which your computer is to be connected, each LAN can be accessed by selective use of the profiles.

2. Enter the network name (SSID).
Enter the appropriate network name according to the “Operation mode” to be used. Enter the desired network name in less than 32 ASCII characters.
 - For infrastructure connection
Select [Infrastructure-Connect to an Access Point] of the selected “Operation mode”, and assign the appropriate data according to the ID code of the Access Point to be accessed. For Access Point setting, refer to the manual of the Access Point.
 - For ad hoc connection
Select [Ad hoc-Connect directly to other computers] of the selected “Operation mode”, and assign the same network name to all the personal computers to be connected.

Critical Points

- ◆ No data needs to be entered in [Mandatory access point].

5. Click the [Next] button.

6. Set security.

1. Select [Network Authentication].
Depending on the ID code of the Access Point to be accessed, select whether you desire network authentication.
 - [No]
Select [No] if you desire open-system authentication or open-key authentication.
 - [Yes]
Select [Yes] if you desire shared-key authentication.

Critical Points

- ◆ Network authentication cannot be selected for ad hoc connection.
2. Select [Data encryption (WEP)].
Specify the method of encoding communications data.
 - “None”
Encoding is not assigned.
 - “64-bit” or “128-bit”
Specify the network key in a 64-bit or 128-bit format. Use either [Use pass phrase] or [Use WEP Keys] to enter the network key.

Critical Points

- ◆ If [Use pass phrase] has been selected above, enter an ASCII character string consisting of five or thirteen characters.
The characters that can be used for [Path phrase] are as follows:
0 - 9, A - Z, a - z
 - ◆ If [Use WEP Keys] has been selected, enter a hexadecimal number consisting of 10 or 26 characters.
The characters that can be used for [Key] are as follows:
0 - 9, A - F
3. Select [Key index].
- For infrastructure connection
Any number from “1” to “4” can be assigned to [Key index]. Usually, however, assign only “1”.
 - For ad hoc connection
[Key index] cannot be selected.

Critical Points

- ◆ For infrastructure connection
Set the appropriate key index according to the ID code of the Access Point to be accessed. For Access Point setting, refer to the manual of the Access Point.
 - ◆ For ad hoc connection
The same key index number must be set for all the personal computers to be connected to the wireless LAN.
The index number may range from 0 to 3 or from 1 to 4, depending on factors such as the type of equipment and the version number of the operating system (OS).
Be careful since the index number has the following relationship with respect to this personal computer:
 - If the index number of the key is from 0 to 3
The index number corresponding to this personal computer is “0”.
 - If the index number of the key is from 1 to 4
The index number corresponding to this personal computer is “1”.
7. Click the [Finish] button.
[Profile Wizard] will be terminated and the created profile added to [Profile List] of the [Network] tab.

Critical Points

- ◆ About [Advanced Security Settings]
The currently valid profile can be protected with the password.
To make the password protection valid, tick the [Password protect this profile] check box and then click the [Next] button. The password entry window will be displayed.

Connection to the network

This section explains connection to the network.

If there is the administrator of the network, contact the network administrator for data settings.

Setting the network

Perform the [Setting TCP/IP] and [Computer Name and Workgroup] operations required for network connection.

□ Setting TCP/IP

Critical Points

- ◆ To change the setting of the IP address, you need to be log in from Windows as an administrator.
 1. **Click the [Start] button first and then [Control Panel].**
 2. **Double-click the [Network and DIAL-UP Connection] icon.**
The [Network and DIAL-UP Connection] window will be displayed.
 3. **Right-click [Local Area Connection], and click [Properties] in the menu displayed.**
The [Local Area Connection Properties] window will be displayed.
 4. **Click [Internet Protocol (TCP/IP)] and then click [Properties].**
The [Internet Protocol (TCP/IP) Properties] window will be displayed.
 5. **Set the IP address.**
 - For ad hoc connection
Select [Use the following IP Address] and then enter data in [IP address] and [Subnet mask].
 - For infrastructure connection
Select [Obtain an IP address automatically] and [Obtain DNS server address automatically].
Follow the directions if you are directed from the network administrator about IP address setting, DNS server setting, and the default gateway.
 6. **Click the [OK] button.**
Processing will return to the [Local Area Connection Properties] window.
 7. **Click the [OK] button.**
If a message is displayed that requests you to restart the personal computer, click [Yes] and then restart the computer.

❏ Confirming the Computer Name and the Workgroup Name

Critical Points

- ◆ To modify the computer name and/or the work group name, you need to be logging in from Windows as a user having administrator's authority.
 1. **Click the [Start] button, [Setting], and [Control Panel], in that order.**
 2. **Double-click the [System] icon.**

The [System properties] window will be displayed.
 3. **Click the [Network ID] tab.**
 4. **Confirm the settings of [Computer Name] and [Workgroup].**
 - The setting of [computer name] denotes the name for identifying the computers on the network. Any name can be assigned.

The computer name will be identified more easily if the model number, the user name, and other factors are already set.
 - [Workgroup] denotes the group name of the network.
 - For ad hoc connection
Assign the same network name to all personal computers existing on the network.
 - For infrastructure connection
Assign the name of the work group to be accessed.

Critical Points

- ◆ To change the name, click [Property] and then proceed in accordance with the instruction messages displayed on the screen.

Processing will return to the [System properties] window.
- 5. **Click the [OK] button.**

If a message is displayed that requests you to restart the personal computer, click [Yes] and then restart the computer.

Setting the sharing function

Set the sharing function to make file and/or printer sharing with other network-connected personal computers valid.

The setting operation is not required unless the sharing function is to be used.

The folder and printer for which the sharing function has been set will be usable from any personal computer present on the network.

Critical Points

- ◆ To share a file and/or the connected printer, you need to be logging in from Windows as a user having administrator's authority.

□ Setting the Microsoft network-sharing service

1. **Click the [Start] button, [Set], and [Control Panel], in that order.**
2. **Double-click the [Network and DIAL-UP Connection] icon.**
The [Network and DIAL-UP Connection] window will be displayed.
3. **Right-click [Local Area Connection], and click [Properties] in the menu displayed.**
The [Local Area Connection Properties] window will be displayed.

Critical Points

- ◆ If multiple [Local Area Connection] items are displayed, select the [Local Area Connection] item where the setting of [Device name] is [Intel(R) PRO/Wireless LAN 2100 3B Mini PCI Adapter].
4. **If [File and Printer sharing for Microsoft Networks] is displayed, proceed to step 5.**
If [File and Printer sharing for Microsoft Networks] is not displayed, skip to step 6.
 5. **Make sure that the [File and Printer sharing for Microsoft Networks] check box is ticked, and then click the [OK] button.**
 6. **Click [Install].**
The [Select Network Component Type] window will be displayed.
 7. **Click [Service], and then click the [Add] button.**
The [Select Network Service] window will be displayed.
 8. **Click [File and Printer sharing for Microsoft Networks] and then click the [OK] button.**
Processing will return to the [Local Area Connection Properties] window, and [File and Printer sharing for Microsoft Networks] will be added to the list.
 9. **Click the [OK] or [Close] button.**

❑ Setting the file sharing function

The procedure for setting the file-sharing function is shown below taking the “work.” folder within drive C as an example.

1. **Double-click [My Computer] on the Desktop, and then double-click [Local disk (C:)].**
2. **Right-click the “work.” folder, and then click [Sharing] in the menu displayed.**
The [work properties] window will be displayed.
3. **Select [Share this folder] and then enter data in necessary items.**
 - “Share Name”
Enter the name of the folder to be shared.
 - “Comment”
Enter explanatory statements on the folder to be shared.
 - “User limit”
Enter the number of users who share the folder.
 - “Access permission”
Enter the access level with respect to the folder.
 - “Cache”
Set the cache for the folder.
4. **Click the [OK] button.**
The folder will be set as a sharable folder, and the display of the icon for the “work.” folder will change.

❑ Setting the printer-sharing function

1. **Click the [Start] button, [Setting], and [Printers].**
A list of connected printers will be displayed.
2. **Right-click the printer for which the sharing function is to be set, and then click [Sharing] in the menu displayed.**
The property window corresponding to the selected printer will be displayed.
3. **Click [share as] and after confirming the name of the printer to be shared, click the [OK] button.**
Printer sharing will be set and the display of the icon for the printer will change.

Confirming connection

After you have finished the network setup operations, access the folder whose sharing has been set for other personal computers. Also, confirm the status of the radio waves in case of trouble such as a network connection failure.

Critical Points

- ◆ In the case of infrastructure connection, enter the necessary data for the Access Point before confirming connection. Refer to the manual of the Access Point for the Access Point setup procedure.

□ Connecting your personal computer to another personal computer

1. **Double-click [My Network] on the Desktop.**
The window [My Network] will be displayed.
2. **Double-click the [Computers near me] icon.**
The personal computers connected to the network will be listed.
3. **Double-click the name of the personal computer to which you wish to connect your own personal computer.**
The folder that has been set in [Shared folder] will be displayed.
4. **Double-click the folder to be accessed.**
The contents of the folder will be displayed to indicate that the folder has become usable.

□ Confirming the status of the radio waves

1. **Click the [Start] button, [Programs], [Intel Network Adapter], and [Intel(R) PROSet], in that order.**
The [Intel(R) PROSet] window will be displayed.
2. **Click the [General] tab and confirm radio-wave status in the window displayed.**
The current connection status will be displayed.
 - Quality of the signals
The quality of the signals is displayed on a graph.
 - Network name (SSID)
The connected network name (SSID) is displayed.
 - Profile name
“<No profile>” is displayed.
 - Mode
If infrastructure connection is in use, “Infrastructure (Access point)” will be displayed.
If ad hoc connection is in use, “Ad hoc” will be displayed.
 - Security
The setting status of WEP is displayed.

- Speed
The communications speed is displayed.
- Band (Frequency)
The current operating frequency band is displayed.
- Channel
The channel number currently being used for the communications is displayed.

Appendix

❏ Other Settings

Other wireless LAN settings are described.

Setting of power-saving function

After you have finished the network setup operations, access the folder whose sharing has been set for other personal computers. Also, confirm the status of the radio waves in case of trouble such as a network connection failure.

IMPORTANT

- You can set the power-saving function of wireless LAN. Default setting is auto-setting. In case of using the power-saving function, manually control the communication performance.

1. Click the [Start] button, [All Programs], [Intel Network Adapter], and [Intel(R) PROSet], in that order.

The Intel(R) PROSet window will be displayed.

2. Click [Adapter] tab.

3. Click [Configure] in [Power setting].

[Power setting] window will be displayed.

4. After selecting [Manual], control the bar to set the power-saving function.

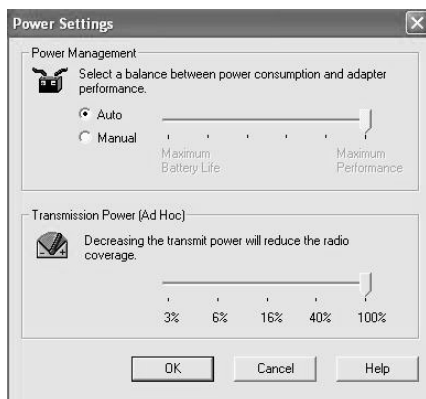

Setting of transmission power during ad hoc connection

IMPORTANT

- By controlling the transmission power during ad hoc connection, you can increased or decreased the communication range. This setting is only effective during ad hoc connection. It will be ineffective during infrastructure connection.

1. Click the [Start] button, [All Programs], [Intel Network Adapter], and [Intel(R) PROSet], in that order.
The Intel(R) PROSet window will be displayed.
2. Click [Adapter] tab.
3. Click [Configure] in [Power setting].
[Power setting] window will be displayed.
4. Control the “Transmission power (ad hoc)” bar to set the transmission power.

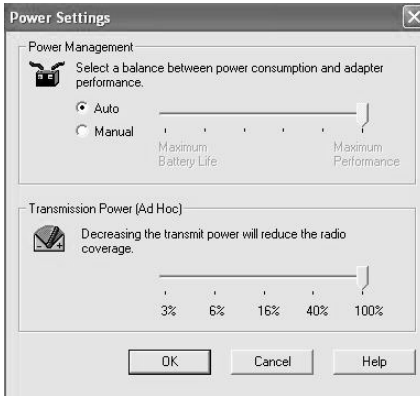

Setting of channels during ad hoc connection

IMPORTANT

- You can set channels during ad hoc connection.
 - Channel 11 is set by default.
 - In case of connecting to the existing ad hoc network, no channel setting will be effective.
 - This setting is only effective during ad hoc connection. It will be ineffective during infrastructure connection.
1. Click the [Start] button, [All Programs], [Intel Network Adapter], and [Intel(R) PROSet], in that order.
The Intel(R) PROSet window will be displayed.
 2. Click [Adapter] tab.
 3. Click [Setting] in [Ad hoc setting].
[Ad hoc setting] window will be displayed.
 4. Change channels during ad hoc connection.

Troubleshooting

Causes and countermeasures for troubles you may encounter while using wireless LAN are described. Refer to the relevant item.

Unavailable connection to the network

- Even if you double-click [Network computer] icon, no other computer will be displayed or no connection can be established if it is displayed.
- During infrastructure connection, you cannot connect to the Access Point.

❑ Causes

- “Incorrect network name (SSID) or network key”
- “Unreachable electric wave due to poor condition of electric wave”
- “Under the condition of stopped electric wave transmission”
- “The computer to be connected with is turned OFF.”
- “Active channel duplication due to multiple wireless LAN networks on the same floor, etc.”
- “No right of access to the network to be connected with”
- “The set channel for the Access Point is different from those which can be used by this computer.”
- “It takes too long to retrieve the network and display the connected computers.”
- “Incorrectly-performed network setting”
- “Incorrect setting of IP address”
- “Unmatched “Network authentication (shared mode)” settings in case of Windows XP”

❑ Incorrect network name (SSID) or network key

○ Countermeasure

In case of ad hoc connection, set the network names (SSIDs) and network keys of all computers to be connected to the same values. In case of infrastructure connection, set the network name (SSID) and network key to the same values as those of Access Point. Also, set the network authentication according to the Access Point.

Unreachable radio wave due to poor condition of radio wave

Countermeasure

In case of ad hoc connection, retry connection after shortening the distance to the destination computer or removing any obstacle for better sight. In case of infrastructure connection, retry connection after shortening the distance to the Access Point or removing any obstacle for better sight.

- **Windows XP**
- **Windows 2000**

Under the condition of stopped radio wave transmission

Countermeasure

Check if the wireless switch is turned ON. Also make sure of "Disable Radio" (condition of sending radio wave) in "Network setting" window.

The computer to be connected with is turned OFF.

Countermeasure

Check if the computer to be connected is turned ON.

Active channel duplication due to multiple wireless LAN networks on the same floor, etc.

Countermeasure

If there is any other wireless LAN network nearby, change channels to avoid active channel duplication.

No right of access to the network to be connected with

Countermeasure

Check if you have a right of access to the network to be connected with.

- The set channel for the Access Point is different from those which can be used by this computer.**

- Countermeasure**

Set the channel of Access Point within the range of 1~14. For the method of setting, refer to the Access Point manual.

- It takes too long to retrieve the network and display the connected computers.**

- Countermeasure**

Retrieve computers in the following procedure:

- **In case of Windows XP**

1. Click [Start] button, then click [Search].
2. Click [Computer or people].
3. Click [Computers on the network].
4. Input the name of computer to be connected with in [Computer name] and click [Find].
5. Double-click the icon of connected computer.

- **In case of Windows 2000**

1. Click [Start] button -> [Search] -> [Files and folders].
2. Click [Computer] in [Search for Files Folders].
3. Input the name of computer to be connected with in [Computer name] and click [Search Now].
4. Double-click the icon of connected computer.

- Countermeasure**

Check the protocol, work group name or shared setting.

❑ Incorrect setting of IP address

○ Countermeasure

Check the network setting.

In case of using TCP/IP protocol, you can check IP address in the following procedure:

1. Perform checking as follows:
 - In case of Windows XP
Click [Start] button -> [All programs] -> [Accessories] -> [Command prompt].
 - In case of Windows 2000
Click [Start] button -> [Program] -> [Accessories] -> [Command prompt].
2. In [Command prompt] or [MS-DOS prompt] window, input [IPCONFIG] command as follows to press [Enter] key.

```
IP Address.....: 10.0.1.3
Subnet Mask.....: 255.255.255.0
Default Gateway.....: 10.0.1.1
```

Critical Points

- ◆ When IP address is displayed as [169.254.XXX.YYY] or [0.0.0.0], IP address is not correctly fetched from the Access Point. In that case, restart the computer itself. If the display is still unchanged, check the setting of TCP/IP.
- ◆ If [Cable Disconnected] or [Media Disconnected] is displayed without showing IP address, check the setting of network name (SSID) and network key. Also, set the network authentication according to the Access Point.

❑ Unmatched [Network authentication (shared mode)] settings in case of Windows XP

○ Countermeasure

If the setting of [Network authentication (shared mode)] is not matched with that of Access Point or computer to be connected with, no communication can be established.

Connection check with executed PING command

Check if IP packet has correctly reached the destination by executing PING command in the following procedure:

Critical Points

◆ In order to execute PING command, it is necessary to install TCP/IP protocol in advance.

1. Perform the following procedure:-

In case of Windows XP

Click [Start] button -> [All programs] -> [Accessories] -> [Command prompt].

In case of Windows 2000

Click [Start] button -> [Program] -> [Accessories] -> [Command prompt].

2. At command prompt, input ping command as follows:

Example: If IP address set as 10.0.1.3

If properly connected, the following screen will be displayed:

```
Pinging 10.0.1.3 with 32 bytes of data:
Reply from 10.0.1.3: bytes =32 time =1ms = 32
Reply from 10.0.1.3: bytes =32 time <10ms TTL = 32
Reply from 10.0.1.3: bytes =32 time =4ms TTL = 32
Reply from 10.0.1.3: bytes =32 time =10ms TTL = 32
```

In case of no connection, "Request timed out" or "Destination host unreachable" will be displayed.

Disconnected communication a few minutes after every connection to the station

In case of Windows XP, check the setting of "Enable network access control using IEEE 802.1X".

Critical Points

- ◆ In case of restricting the access of wireless LAN clients using IEEE802.1X authentication, put a check mark on " Enable network access control using IEEE 802.1X ".In case of home use, remove a check mark on "Enable network access control using IEEE802.1X".For the method of setting related with IEEE802.1X authentication, refer to the Access Point manual.

SECTION

2

This section explains installation of options for this computer.

1 Options

Options

You can expand the functions of this computer by connecting various options, which are sold separately.

Fujitsu offers some of the optional accessories. Please check with your local Fujitsu sales representative on the available option list.

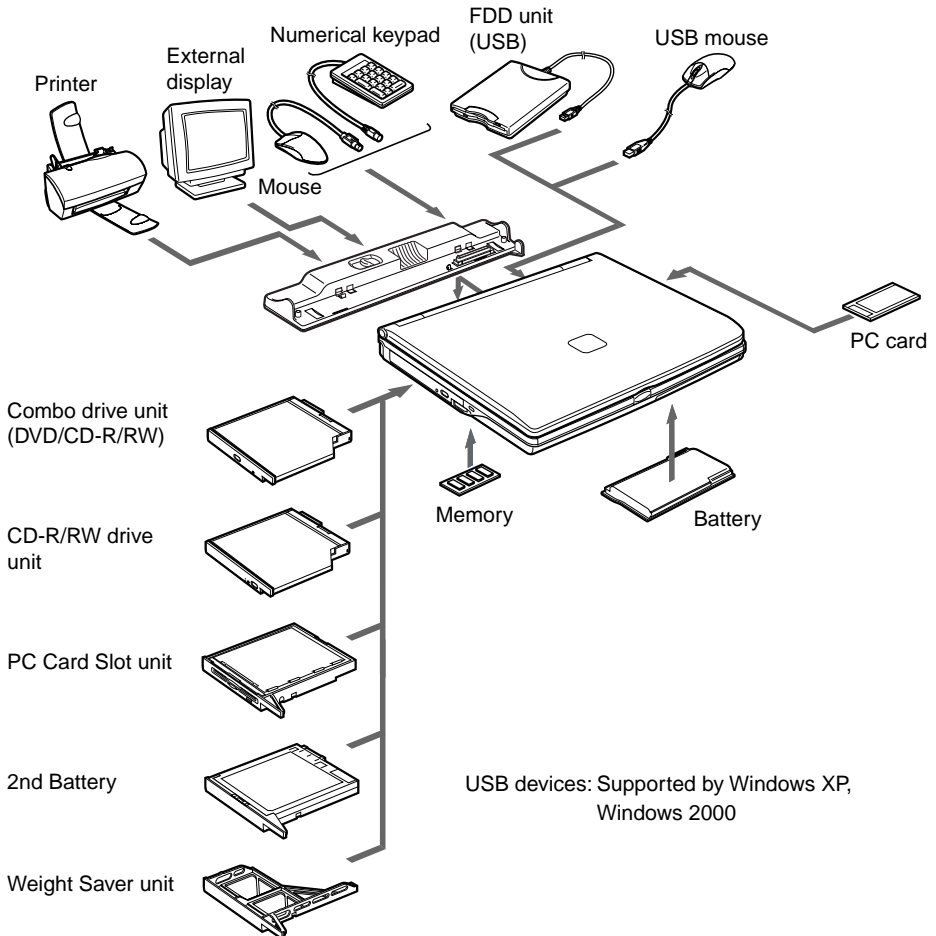

(Your computer or situation may not look exactly like this illustration.)

Peripherals

Below explanation is necessary for your knowledge before connecting your peripherals.

- **Some setting up works are required for a certain peripherals**

You cannot use some PC peripherals just by connecting it to a PC. Those peripherals require some setting up work after connection. For example, printers and PC cards require “driver installation” work after connecting them. And memory and other peripherals do not require such setting up works. Make sure to consult with this document for the peripheral connection to complete the work correctly.

- **See also the documents for the peripherals**

The peripheral installation methods shown in this document are only a few examples. Make sure to consult with the documents for the peripherals as well as this document.

- **Use genuine products**

Use genuine optional device from our company. We cannot guarantee proper function on this PC for the peripherals from other sources. When it is necessary to use the peripheral from the other source, consult with the manufacturer of the product.

- **Use the peripherals that conform to ACPI standard**

This PC is set to ACPI mode for Windows XP and Windows 2000. Power save and other functions may not work correctly if a peripheral does not conform to ACPI mode.

- **Notes on installation/removal**

The installation of the peripheral must be done after the setting up of an operating system except for a PS/2 mouse. The set-up function might not complete correctly if such a peripheral is attached before the operating system set up.

Critical Points

- ◆ When you connect a peripheral to a connector, make sure that the direction of the connection is correct and connect straight.
- ◆ When you connect more than one peripherals, complete setting for each peripherals before installing others.

2 Adding Memory

❑ Where to install memory

Your computer has an expansion RAM module slot (slot 2) so that memory can be added. Your computer came with 256/512 MB of memory installed in slot 1. (depends on the model you have)

The memory capacity of your computer can be increased to a maximum of 1GB (512 MB of memory x 2).

❑ Preparing necessary items

Philips screwdriver (No. 1)	Used to remove screws from the computer. To avoid damage to screw heads, use a screwdriver appropriate to the size of the screws (M2.5).
-----------------------------	--

Critical Points

◆ Table of combinations of memory

The table below shows combinations of memory that can be installed on your computer.

The installation of any combination of memory other than the combinations shown below can impair the functioning of your computer.

- Model with 256MB as standard memory.

Total capacity	Slot 1	Slot 2
256 MB (Installed as standard)	256 MB	
384 MB	256 MB	128 MB
512 MB	256 MB	256 MB
768 MB	256 MB	512 MB
1 GB (Maximum)	512 MB*	512 MB

* The memory currently installed in slot 1 needs to be removed.

- Model with 512MB as standard memory.

Total capacity	Slot 1	Slot 2
512 MB (Installed as standard)	512 MB	
640 MB	512 MB	128 MB
768 MB	512 MB	256 MB
1 GB (Maximum)	512 MB	512 MB

❑ Installing memory

To install memory, perform these steps.

WARNING

ELECTRIC SHOCK



- When installing or removing memory, be sure to turn off your computer and disconnect the AC adapter from it to avoid shock hazards.

SUFFOCATION



- Keep small objects, such as a cover, caps and screws, out of the reach of babies and children to avoid the danger of suffocation.
In case a baby or child has swallowed such an object, consult the doctor immediately.

CAUTION

HOT



- Some components around the memory slot are very hot immediately after use. To avoid burns, do not install or remove memory immediately after turning off the computer but wait for a while until its internal components cool down.

BREAKAGE



- When installing or removing memory, hold its edge so as not to touch any terminal or IC. Also, be careful not to touch internal components or terminals of the computer. Touching these parts with oily fingers could result in poor electrical contact.



- Memory is composed of static-sensitive parts, and it is easily broken by static discharged from a human body. Before touching memory, always touch an appropriate metal object to discharge static from your body.



- When installing or removing memory, be sure to turn off your computer. If you install or remove memory with the computer placed in standby or hibernation mode, data not saved could be lost or the computer or memory could be broken.

Critical Points

- ◆ To avoid damage, do not touch internal components unnecessarily.
- ◆ To avoid damage, be careful not to drop small objects removed, such as screws, into the computer.

1. Turn off your computer and disconnect the AC adapter from it.
2. Close the LCD panel, and place the computer upside down.
3. Remove the screws (two) securing the expansion module slot cover and remove the cover.

Remove the expansion module slot cover at the bottom of the computer.

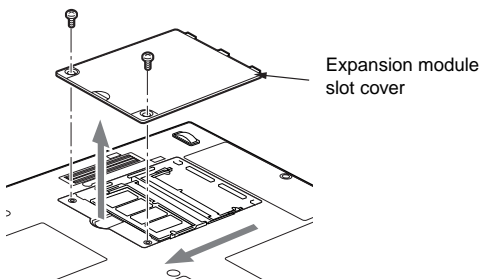

(Your computer or situation may not look exactly like this illustration.)

4. Install memory.

Insert the memory module into the slot with the notch in the memory module aligned with the projection on the connector, and turn it down until it clicks into place.

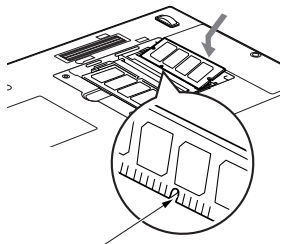

Notch in the module

5. Attach the expansion RAM module slot cover and secure it with the screws.

Attach the cover removed in step 3.

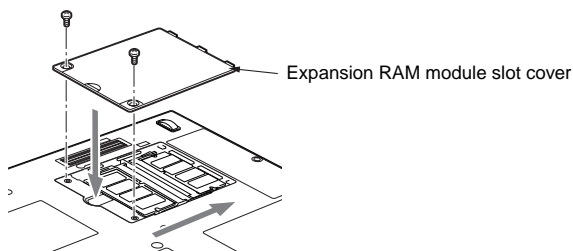

(Your computer or situation may not look exactly like this illustration.)

Checking the memory capacity

IMPORTANT

- In case memory is not installed properly, the error message “Expansion memory error” or another message will be displayed in English when you first turn on the computer after installing the memory. If such a message appears, press the power button to shut down the computer, and reinstall the memory.

1. Turn on the computer.

2. Click the Start button and select Control Panel.

The Control Panel window is displayed.

3. Click Performance and Maintenance, and then System.

The System Properties dialog box is displayed.

4. Check whether the circled numeric value in the figure below has increased by the size of the memory you have added.



In this example, 512 MB of memory installed.

* The memory capacity displayed is 8 MB less than the actual memory capacity, since your computer uses 8 MB of memory exclusively for graphics.

5. Click OK.

The Performance and Maintenance window appears again.

Critical Points

- ◆ If the numeric value displayed does not agree with the memory capacity of your computer, check to see if the memory is installed properly.

□ Changing memory

The memory installed on your computer can be replaced with a larger size of memory.

1. Turn off your computer and disconnect the AC adapter from it.
2. Close the LCD panel, and place the computer upside down.
3. Remove the screws (two) securing the expansion RAM module slot cover and remove the cover.

Remove the expansion RAM module slot cover at the bottom of the computer.

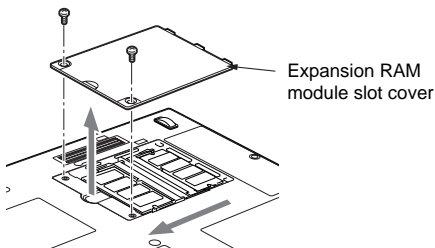

(Your computer or situation may not look exactly like this illustration.)

4. Remove the memory.

Remove the hook on each side from the memory module. The memory comes up slightly. Then, pull the memory diagonally up to detach it from the slot.

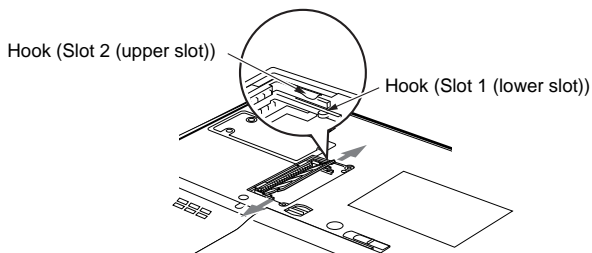

5. Install a new memory module.

Insert the memory diagonally into the slot with the notch in the memory aligned with the projection on the connector, and then turn the memory down until it clicks into place.

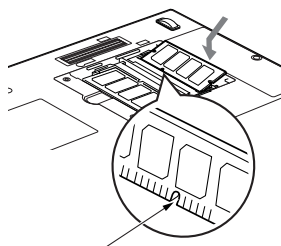

Notch in the memory

6. Attach the expansion RAM module slot cover.

Attach the cover removed in step 3.

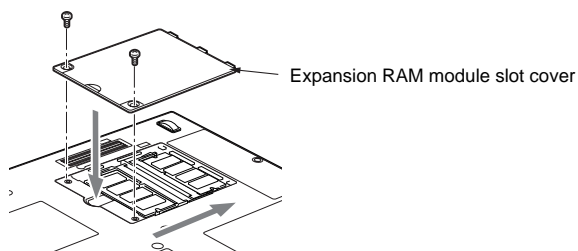

(Your computer or situation may not look exactly like this illustration.)

Critical Points

- ◆ After you have changed memory, check the memory capacity of your computer to be sure that the memory is installed properly.

3 Connecting a USB Device

□ Preparing necessary items

USB devices	<p>Devices that can be plugged in USB ports on your computer. Prepare USB device that meets your needs.</p> <ul style="list-style-type: none"> • Digital camera • Mouse • Printer • Scanner • Keyboard
USB cables	<p>Used to connect a USB device to your computer. Some USB devices come standard with a cable as separate part, and others come with a cable already connected like a mouse. For more information, refer to the documentation supplied with the your USB device.</p>
USB device drivers	<p>Some USB devices come with a CD or floppy disk containing their respective drivers. If necessary, install a Windows-compatible driver according to the instructions in your USB device manual.</p>
USB device instruction manual	<p>Ways of connection cables vary from USB device to USB device. Before connecting a USB device for the first time, read its manual carefully.</p>

Critical Points

- ◆ Each USB port on your computer is capable of supplying the USB device connected with power of up to 500 mA. For more information, refer to the documentation supplied with your USB device.

Connecting a USB device

1. **Plug a USB cable in the connector of your USB device.**
2. **Plug the cable from the USB device in a USB port on the back of your computer.**
Insert the connector with the face marked with  up.

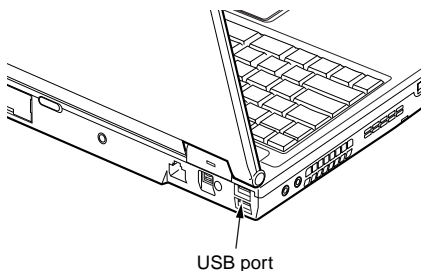

(Your computer or situation may not look exactly like this illustration.)

3. **Install the driver.**
Some USB devices require no driver to be installed. For information about this, refer to the documentation supplied with your USB device.

Critical Points

- ◆ If the Install Hardware dialog box appears when you connect the USB cable, click Continue to continue the installation of the driver.

4 Connecting an External Monitor

□ Preparing necessary items

External monitor	Your computer supports PC/AT-compatible and DOS/V-compatible monitors.
Monitor cable	Used to connect an external monitor to your computer. Most external monitors come with this cable, as a separate part for some monitors and already connected for others. If this cable is not included with your monitor or it cannot be plugged in the external monitor port of your computer, prepare a PC/AT-compatible or DOS/V-compatible monitor cable with a connector that fits the external monitor port of your computer.
Instruction manual for your external monitor	Ways of connecting cables vary from monitor to monitor. For the way of connecting your monitor, therefore, refer to the documentation supplied with it.

Connecting an external monitor

This section explains how to connect a CRT monitor to your computer via the external monitor port on its back.

WARNING

ELECTRIC SHOCK



- Before connecting or disconnecting an external monitor, always turn off your computer and disconnect the AC adapter from it to avoid shock hazards.

CAUTION

BREAKAGE



- Connect cables correctly according to the instructions in this manual. Incorrect connection of the cable could result in damage to your computer and monitor.

1. Turn off the computer and disconnect the AC adapter from it.
2. Plug the monitor cable in the external monitor port on the back of the computer.

The external monitor port has a trapezoidal cross-section.

(1) Insert the connector straight into the external monitor port with the right side up, and (2) secure it with the screws on both sides of the connector.

External monitor port

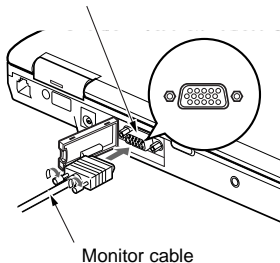

(Your computer or situation may not look exactly like this illustration.)

3. Connect the other end of the cable to the CRT monitor.

For the way of connecting the cable to your monitor, refer to its manual.

4. Plug the power cable of the CRT monitor in a wall outlet, and then turn on the monitor.

5. Connect the AC adapter to your computer, and turn on the computer.

After that, switch from the LCD monitor to the external CRT monitor if you like.

If the Add New Hardware Wizard appears after you have connected the external display, perform these steps.

- Some external monitors come with a CD or floppy disk containing files necessary for using them. If a CD or floppy disk is included with your monitor, install all necessary files according to the instructions in your monitor manual.

Critical Points

- ◆ In some cases, images are displayed on both the LCD screen of your computer and the external monitor connected.

SECTION

3

This section explains what to do when trouble occurs with this computer and when messages are displayed. Read this section as the necessity arises.

1 When This Happens

When you are having trouble with this computer, there is something you think is strange, or there is something you want to do, but do not know how. This section is divided into related items.

❑ The power does not come on.

Checkpoint	Cause and Solution
Is the AC adaptor connected?	When using this computer for the first time after purchase, the battery is not yet charged, so you must connect the AC adaptor and turn on the main switch.
Is the main switch turned on?	If the main switch is not turned on, the power will not come on even if the SUS/RES button is pressed.
Is the battery charged?	If a beep is heard when the main switch is turned on, then the battery is running low (LOW BATTERY). Connect the AC adaptor.
Has the computer been left unused for a long time?	When using the computer for the first time after leaving it unused for a long time, connect the AC adaptor and switch on the main switch to switch on the power.

❑ Nothing displayed on the LCD panel

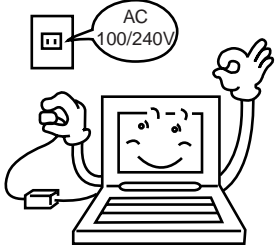
Checkpoint	Cause and Solution
<p>Is  displayed on the LCD panel?</p> 	<ul style="list-style-type: none"> • Displayed Adjust the brightness and darkness with the brightness and contrast controls. • Flashing or not displayed Press the SUS/RES button to put the computer into operating mode. Check if the battery is charged. If it is not charged, connect the AC adaptor and charge it. If you are already using this computer with the AC adaptor connected, check that it is correctly plugged into the power socket and into the computer.
Is anything displayed on the status indicator LCD?	Connect the AC adaptor and switch on the main switch.

Checkpoint	Cause and Solution
Have you been pressing any of the keys?	On this computer, if the power management functions are set and no key is pressed for a certain period of time, the CPU stops and the LCD panel backlight goes out. (In this state, pressing any key lights up the backlight again.) If the computer stops too frequently, change the BIOS setup settings.
Is it set to output to the CRT?	Switch over to the LCD display with the [Fn] + [F10] keys.

LCD panel hard to read

Checkpoint	Cause and Solution
Is the control adjusted?	Adjust the brightness with the brightness and contrast controls.

Battery is not charged

Checkpoint	Cause and Solution
Is the AC adaptor connected?	Check that the AC adaptor is correctly plugged into the power socket and into the computer.
Is the battery overheated (The → on the LCD display flashes.)?	If the ambient temperature is high and the battery temperature becomes too high during use, the battery protection function may be triggered to stop the charging.
Is the computer too cold (The → on the LCD display flashes.)?	If the battery temperature falls too low, the battery protection function may be triggered to stop the charging.
Was the charging stopped midway?	If you use the computer and disconnect the AC adaptor between the start of charging and the time the → LCD turns off, then the battery will not become fully charged. Once you start charging do not remove the AC adaptor until the → LCD turns off.

❑ The remaining battery charge indicator does not stop flashing.

Checkpoint	Cause and Solution
Is the battery connected correctly?	Check that the battery is connected correctly. If it is connected correctly, there is an abnormality in the battery pack, so replace the battery pack.
Is the battery low?	Attach the AC adaptor and charge the battery.

❑ Floppy disk can not be used.

Checkpoint	Cause and Solution
If the floppy disk loaded into the floppy disk drive correctly?	Insert the floppy disk with its label facing up, into the drive shutter and keep inserting firmly until you hear a clicking sound.
Is the floppy disk formatted?	New floppy disks can not be used until they are formatted (initialized). Format the floppy disk.
Is Diskette A set to Not Installed in the BIOS setup?	Check the Diskette A item in the BIOS setup Main menu.
Is Diskette access set to Supervisor only in the BIOS setup?	Check the Diskette access item in the BIOS setup Security menu.
Is the floppy disk write inhibited?	Set the write protect tab on the floppy disk to the write enable position.
Does it work with a different floppy disk?	If it works with a different floppy disk then the problem floppy disk may be damaged.

No sound or minimal sound from speaker

Checkpoint	Cause and Solution
Is the volume control correctly adjusted?	Turn the volume control for the correct volume. If this does not change the volume, double click the task bar sound indicator and adjust the volume. Check also whether the sound driver is installed correctly.

Can not record from Mic or Line In jack

Checkpoint	Cause and Solution
Is the mic correctly adjusted?	Turn the volume control to obtain the correct volume. If the line jack is connected to the sound source, then check that connection. If this still does not solve the problem, then double click the task bar sound indicator and adjust the volume.

LCD panel does not close.

Checkpoint	Cause and Solution
Is something caught in the LCD display panel?	Forcing the LCD display panel closed can damage it. Check for something caught in the LCD display panel. Also, a metal object such as a paper clip can cause a breakdown if it gets caught in between the keys.

The power management function is not executed.

Checkpoint	Cause and Solution
Is Power Savings set to off in the BIOS setup?	Reset the BIOS setup.
Are you executing a program that rewrites the screen?	If you are executing a program that rewrites the screen even when no key is pressed, for example a clock display or screen save, the power management function is not executed.

Data cannot be read from the CD-ROM drive.

Checkpoint	Cause and Solution
Is the CD-ROM correctly set?	Set the CD-ROM correctly with its label facing upwards.
Is there any dirt, condensation or water on the CD-ROM?	Wipe it from the center outwards with a dry, soft cloth.
Is the CD-ROM scratched or extremely warped?	Replace the CD-ROM.
Are you using a non-standard CD-ROM?	Use a CD-ROM which conforms to the standards.

The CD cannot be ejected from the CD-ROM.

Checkpoint	Cause and Solution
Is it in operating mode?	<p>The CD can only be ejected when the personal computer main unit is in operating mode because its CD-ROM drive has an electronic lock. Check that the personal computer main unit is in operating mode and press the EJECT button. If for some reason the CD tray does not come out even when you press the EJECT button, insert a clip or something into the hole to the right of the EJECT button and pull the tray out.</p> <p>If the tray doesn't still come out, click the CD-ROM icon in the "My Computer" window with the right button of the mouse and then click "EJECT".</p>

2 Care and Maintenance

If you use your Fujitsu LifeBook notebook carefully, you will increase its life and reliability. This section provides some tips for looking after the notebook and its devices.

Caution:

Electrical equipment may be hazardous if misused. Operations of this product or similar products, must always be supervised by an adult. Do not allow children access to the interior of any electrical products and do not permit them to handle any cables.

LIFEBOOK NOTEBOOK

Caring for your LifeBook Notebook

- Your LifeBook notebook is a durable but sensitive electronic device. Treat it with care.
- Make a habit of transporting it in a suitable carrying case.
- Do not attempt to service the computer yourself. Always follow installation instructions closely.
- Keep it away from food and beverages.
- If you accidentally spill liquid on your notebook:
 1. Turn it off.
 2. Position it so that the liquid can run out.
 3. Let it dry out for 24 hours, or longer if needed.
 4. If your notebook will not boot after it has dried out, call your support representative.
- Do not use your LifeBook notebook in a wet environment (near a bathtub, swimming pool).
- Always use the AC adapter and batteries that are approved for your notebook.
- Avoid exposure to sand, dust and other environmental hazards.
- Do not expose your LifeBook notebook to direct sunlight for long periods of time as temperatures above 140°F (60°C) may damage your notebook.
- Keep the covers closed on the connectors and slots when they are not in use.
- Do not put heavy or sharp objects on the computer.
- If you are carrying your LifeBook notebook in a briefcase, or any other carrying case, make sure that there are no objects in the case pressing on the lid.
- Do not drop your LifeBook notebook.
- Do not touch the screen with any sharp objects.

Cleaning your LifeBook Notebook

- Always disconnect the power plug. (Pull the plug, not the cord.)
- Clean your LifeBook notebook with a damp, lint-free cloth. Do not use abrasives or solvents.
- Use a soft cloth to remove dust from the screen. Never use glass cleaners.

Storing your LifeBook Notebook

- If storing your notebook for a month or longer, turn your LifeBook notebook off and remove all Lithium Ion batteries.
- Store your LifeBook notebook and batteries separately. If you store your notebook with a battery installed, the battery will discharge, and battery life will be reduced. In addition, a faulty battery might damage your notebook.
- Store your LifeBook notebook in a cool, dry location. Temperatures should remain between -25°C (13°F) and 60°C (140°F).

Travelling with your LifeBook Notebook

- Do not transport your LifeBook notebook while it is turned on.
- Do not check your LifeBook notebook as baggage. Carry it with you.
- Always bring your System Recovery CD that came with your LifeBook notebook when you travel. If you experience system software problems while travelling you may need it to correct any problems.
- Never put your LifeBook notebook through a metal detector. Have your notebook hand-inspected by security personnel. You can, however, put your LifeBook notebook through a properly tuned X-ray machine. To avoid problems, place your notebook close to the entrance of the machine and remove it as soon as possible or have your notebook hand-inspected by security personnel. Security officials may require you to turn your notebook On. Make sure you have a charged battery on hand.

Outlet type	Location
	United States, Canada, parts of Latin America, Japan, Korea, the Philippines, Taiwan
	Russia and the Commonwealth of Independent States (CIS), most of Europe, parts of Latin America, the Middle East, parts of Africa, Hong Kong, India, most of South Asia
	Mexico, United Kingdom, Ireland, Malaysia, Singapore, parts of Africa
	China, Australia, New Zealand

- When travelling with the hard drive removed, wrap the drive in a non-conducting materials (cloth or paper). If you have the drive checked by hand, be ready to install the drive if needed. Never put your hard drive through a metal detector. Have your hard drive hand-inspected by security personnel. You can however, put your hard drive through a properly tuned X-ray machine.
- Take the necessary plug adapters if you're travelling overseas. Check the following diagram to determine which plug adapter you'll need or ask your travel agent.

BATTERIES

Caring for your Batteries

- Always handle batteries carefully.
- Do not short-circuit the battery terminals (that is, do not touch both terminals with a metal object). Do not carry loose batteries in a pocket or purse where they may mix with coins, keys, or other metal objects. Doing so may cause an explosion or fire.
- Do not drop, puncture, disassemble, mutilate or incinerate the battery.
- Recharge batteries only as described in this manual and only in ventilated areas.
- Do not leave batteries in hot locations for more than a day or two. Intense heat can shorten battery life.
- Do not leave a battery in storage for longer than 6 months without recharging it.

Increasing Battery Life

- Power your LifeBook notebook through the AC or optional auto/airline adapter whenever possible.
- If your LifeBook notebook is running on battery power all day, connect it to the AC adapter overnight to recharge the battery.
- Keep brightness to the lowest level comfortable.
- Set the power management for maximum battery life.
- Put your LifeBook notebook in Suspend mode when it is turned on and you are not actually using it.
- Limit your DVD/CD-RW/CD-ROM access.
- Disable the Windows CD automatic insertion function.
- Always use fully charged batteries.
- Eject PCMCIA cards when not in use.

FLOPPY DISKS AND DRIVES

Caring for your Floppy Disks

- Avoid using the floppy disks in damp and dusty locations.
- Never store a floppy disk near a magnet or magnetic field.
- Do not use a pencil or an eraser on a disk or disk label.
- Avoid storing the floppy disks in extremely hot or cold locations, or in locations subject to severe temperature changes. Store at temperatures between 50°F (10°C) and 125°F (52°C)
- Do not touch the exposed part of the disk behind the metal shutter.

Caring for your Floppy Disk Drive

- To clean, wipe the floppy disk drive clean with a dry soft cloth, or with a soft cloth dampened with water or a solution of neutral detergent. Never use benzene, paint thinner or other volatile material.
- Avoid storing the floppy disk drive in extremely hot or cold locations, or in locations subject to severe temperature changes. Store at temperatures between 50°F (10°C) and 125°F (52°C)
- Keep the floppy disk drive out of direct sunlight and away from heating equipment.
- Avoid storing the floppy disk drive in locations subject to shock and vibration.
- Never use the floppy disk drive with any liquid, metal, or other foreign matter inside the floppy disk drive or disk.
- Never disassemble or dismantle your floppy disk drive.

□ DVD/CD-RW/CDs

Caring for your DVD/CD-RW/CDs

- DVD/CD-RW/CDs are precision devices and will function reliably if given reasonable care.
- Always store your DVD/CD-RW/CDs in its case when it is not in use.
- Always handle DVD/CD-RW/CDs by the edges and avoid touching the surface.
- Avoid storing any DVD/CD-RW/CDs in extreme temperatures.
- Do not bend DVD/CD-RW/CDs or set heavy objects on them.
- Do not spill liquids on DVD/CD-RW/CDs.
- Do not scratch DVD/CD-RW/CDs.
- Do not put a label on DVD/CD-RW/CDs.
- Do not get dust on DVD/CD-RW/CDs.
- Never write on the label surface with a ballpoint pen or pencil. Always use a felt pen.
- If a DVD/CD-RW/CD is subjected to a sudden change in temperature, cold to warm condensation may form on the surface. Wipe the moisture off with a clean, soft, lint free cloth and let it dry at room temperature, DO NOT use a hair dryer or heater to dry DVD/CD-RW/CDs.
- If a DVD/CD-RW/CD is dirty, use only a DVD/CD-RW/CD cleaner or wipe it with a clean, soft, lint free cloth starting from the inner edge and wiping to the outer edge.

Caring for your DVD/CD-RW/CD-ROM Drive

Your DVD/CD-RW/CD-ROM drive is durable but you must treat it with care. Please pay attention to the following points:

- The drive rotates the compact disk at a very high speed. Do not carry it around or subject it to shock or vibration with the power on.
- Avoid using or storing the drive where it will be exposed to extreme temperatures.
- Avoid using or storing the drive where it is damp or dusty.
- Avoid using or storing the drive near magnets or devices that generate strong magnetic fields.
- Avoid using or storing the drive where it will be subjected to shock or vibration.
- Do not disassemble or dismantle the DVD/CD-RW/D-ROM drive.

PC CARDS**Caring for your PC Cards**

PC Cards are durable, but you must treat them with care. The documentation supplied with your PC Card will provide specific information, but you should pay attention to the following points:

- To keep out dust and dirt, store PC Cards in their protective sleeves when they are not installed in your notebook.
- Avoid prolonged exposure to direct sunlight or excessive heat.
- Keep the cards dry.
- Do not flex or bend the cards, and do not place heavy objects on top of them.
- Do not force cards into the slot.
- Avoid dropping cards, or subjecting them to excessive vibration.