

SANYO

INSTRUCTION MANUAL

SFX-20

Facsimile Transceiver

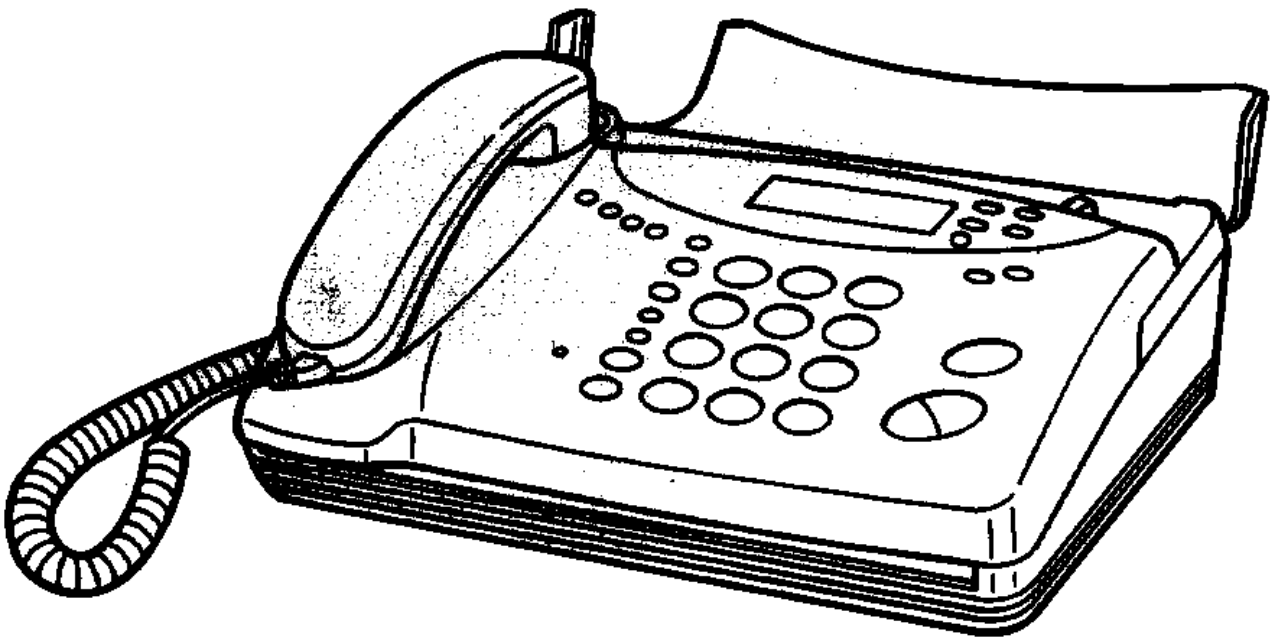

Introduction

Thank you for purchasing the SFX-20. This international-standard high-speed digital facsimile transceiver has many outstanding features, including:

- 5-page automatic document feed
- Automatic switching between telephone, fax machine and answering system (connection-ready)
- 24-number automatic dialing memory
- Paper-save mode reception with reform copy capability
- Superfine resolution
- Halftone
- 30-meter roll of recording paper
- Hands free phone call and conversation
- Dial bank (frequently dialed number can be stored)
- Closed network communication
- 16-character digital display
- Built-in telephone handset
- Voice response (with auto reception)
- Enlargement/reduction copy
- Compatible with new plain-paper quality thermal paper (high-grade thermal paper)

In order to use the SFX-20 effectively and keep it in good working order for a long time, read this instruction manual thoroughly and keep it for future reference.

Table of contents

Before use

Precautions	3
Unpacking	3
Part names and functions	4
Accessories	5
Operation panel	6
Telephone line and AC connections	8
Setting the dialing method	9
Recording paper	10
Confirming proper operation (Copying)	11

Setting up

Header print (setting your station name and fax number)	12
Entering names	14
Calendar and clock	16

Telephone use

Phone calls	17
Hold	18
Redial	18
Hands free phone calls and conversation	19
One-touch dial	21
Speed dial	22
Dial bank	23
Extension telephone/answering machine	24

Fax use

Original documents	25
Transmission	26
Contrast/Resolution	26
Placing original documents	27
Manual dialing transmission	28
Automatic dialing transmission	29
One-touch dialing transmission	30
Speed dialing transmission	31
Dial bank	32
Redial	33
Overseas transmission	34
Reception	35
Reception modes	35
Fax reception mode	36
Telephone reception mode	37
Answer reception mode	38
Remote reception	39
Paper-save reception	40
Phone reservation	41
Copying modes (Enlargement/Reduction/Reform)	42
Issuing memo sheet and fax message sheet	43
Diagnostic reports	44

Programming functions

Menu selection	45
Polling reception	46
Activity report	47
One-touch dial/Speed-dial memory programming	49
Printing a number list	51
Timer transmission	52
Set mode selection	56
Feature switches	57
Feature switch list	59
Closed network communication (feature switch No. 26)	62
Duplex ringing (feature switch No. 56)	63
Black list programming	64
Dial bank editing	66

Maintenance

Thermal paper handling	69
Jammed original	70
Jammed recording paper	71
Cleaning	72
Troubleshooting	74

Specifications

Specifications	76
Optional accessories	76

Precautions

Placement precautions

- Avoid placing the SFX-20 in humid or dusty places, or in places where it will be exposed to excessive heat (direct sunlight, heaters, etc.).
- Do not step on or set anything on the AC cord. **DAMAGE TO THE AC CORD IS A SAFETY RISK AND CAN CAUSE A FIRE.**
- Install the unit only on a stable surface.
- Do not connect the SFX-20 to the same AC outlet as appliances that generate large amount of interference (heaters with thermostats, appliances with motors, etc.). It is best to use a completely separate electrical outlet.
- Keep the SFX-20 away from water. If water accidentally enters the unit, unplug the AC power cord immediately. **DO NOT PLUG THE UNIT IN AGAIN.** Contact an authorized Sanyo service center or dealer.

Before use

Handling precautions

- Avoid bending, kinking or damaging the power cord.
- Never insert or remove the power cord with wet hands. Also, be sure to hold the cord by the plug when removing it from the outlet.
- Do not remove any parts that are held in place with screws. (The SFX-20 does not contain any user-serviceable items.)
- Maintain standard room temperature 5°C-35°C(41°F-95°F) during use. Do not subject the unit to shock or vibration. Do not move the unit while it is in use.
- A rapid increase in room temperature in cool weather can cause condensation to form inside the unit. If this happens, wait at least 15 minutes after turning the unit on before attempting to operate it. Failure to do so may result in paper jams and/or poor print quality.
- When cleaning the cover or operation panel of the unit, wipe gently using a damp cloth to which a small amount of a neutral detergent has been added. **NEVER USE SOLVENTS OR CHEMICALLY TREATED CLOTHS.**

Unpacking

To unpack the SFX-20:

1. Open the carton.
2. Remove the accessories (handset, recording paper roll, etc.) from the carton.
3. Remove the fax machine along with the foam braces on both sides.
4. Remove the polyethylene wrapping around the fax machine.
5. Remove the transportation tapes.
6. Save the carton and the foam braces for later storage and/or shipping.
7. Place the machine where there is access to an AC outlet and a modular phone jack. (Be sure to observe the precautions.)

Part names and functions

Front view

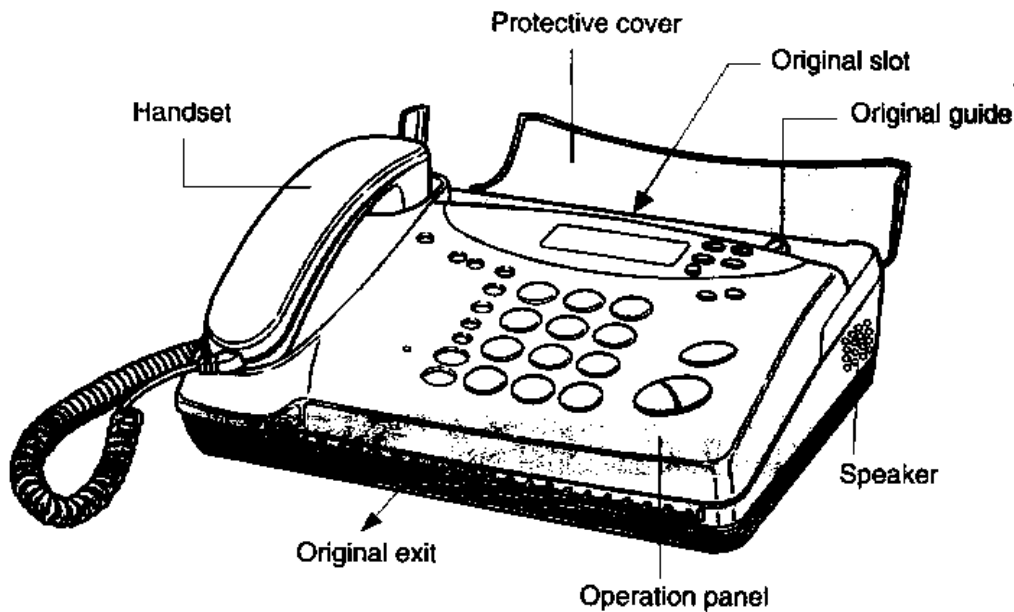

Rear view and left side

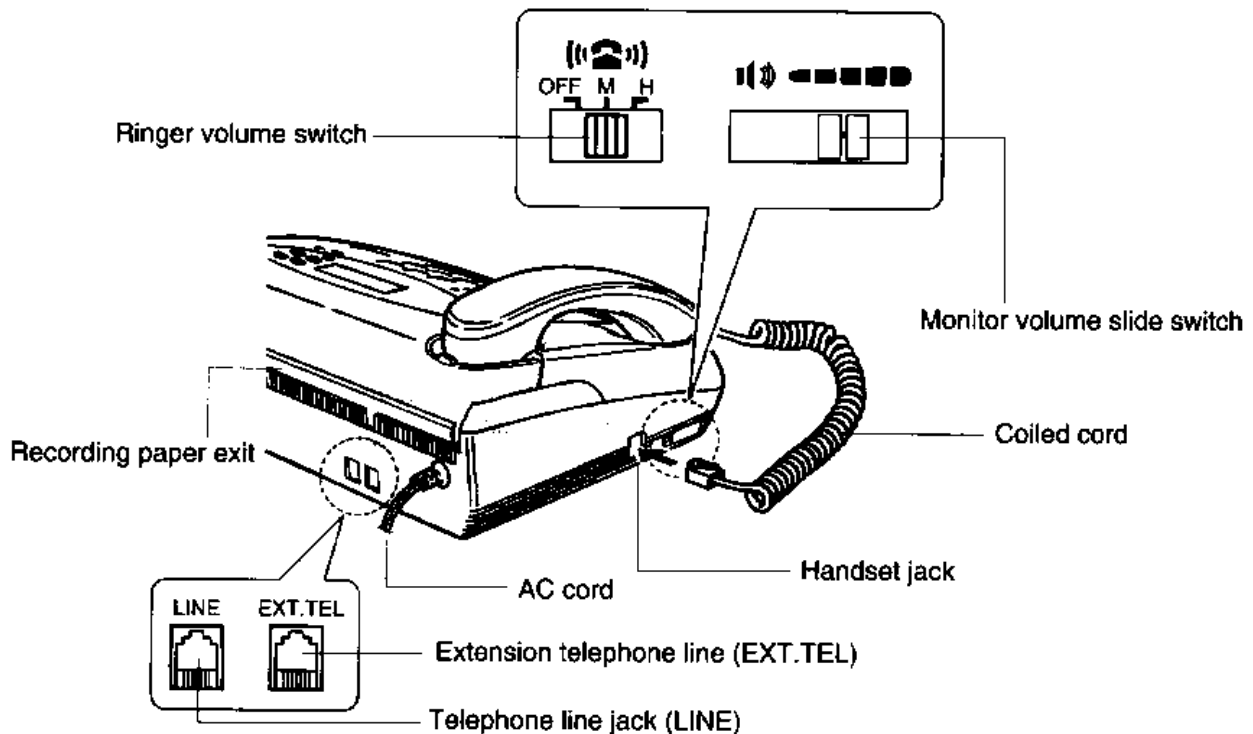

Inner view

Before use

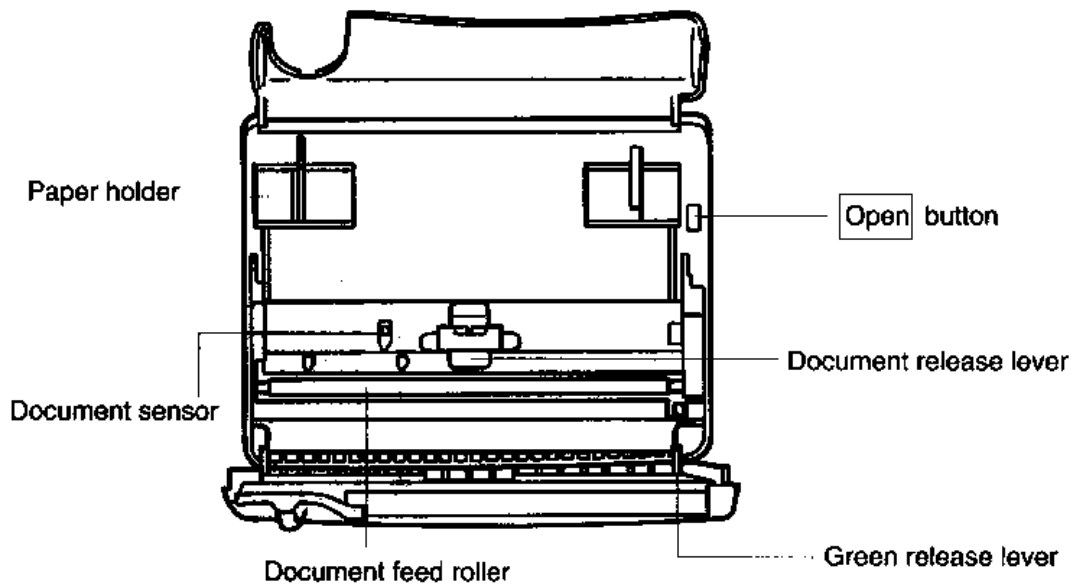

Accessories

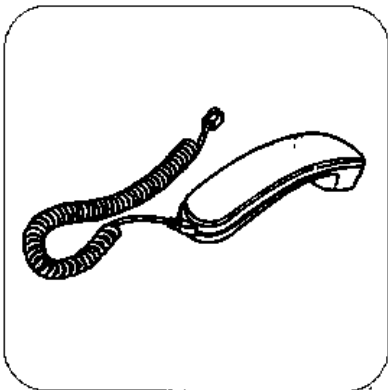

● Handset with coiled cord x 1

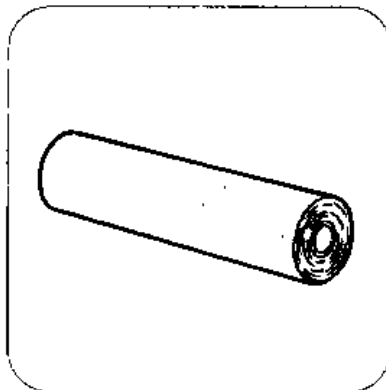

● Thermal paper x 1

- Telephone line cord x 2
- Adhesive label x 2
- Instruction manual x 1

Operation panel

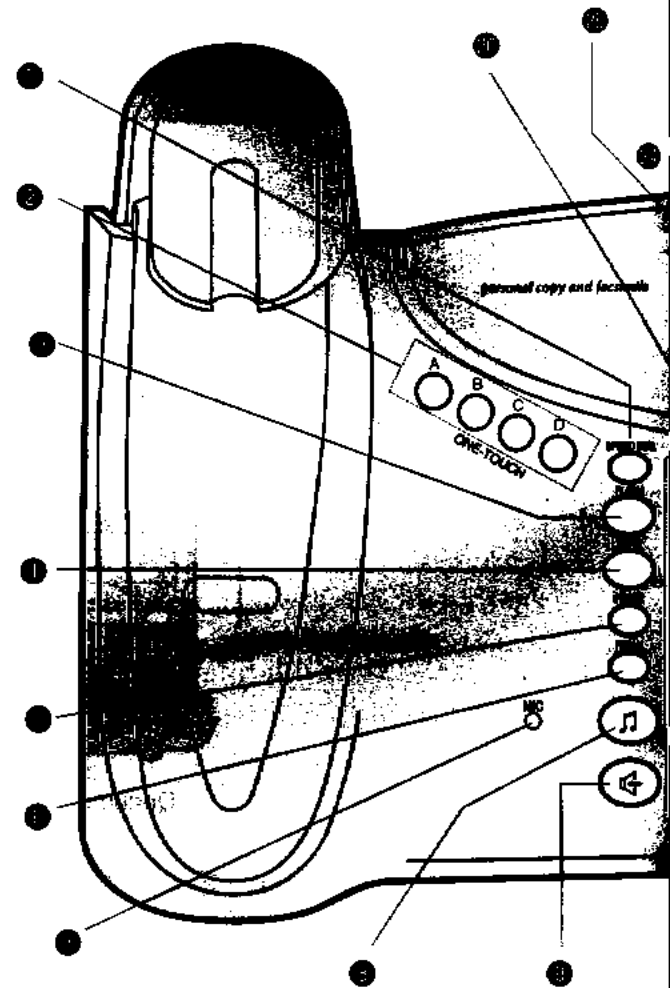

① [SPEED DIAL] key	● Press this key when using speed dial.
② ONE-TOUCH keys	● Frequently dialed numbers can be stored in memory using these 4 keys.
③ [FLASH] key (See Note)	● Press this key to transfer a call from PABX extension to other PABX extension.
④ [TONE] key	● Press this key to switch from pulse dialing to Touch-Tone dialing.
⑤ [PAUSE] key	● Press this key to insert a pause between two digits in a number being dialed.
⑥ [REDIAL] key	● Press this key to redial the last number dialed.
⑦ MIC(Microphone)	● This microphone is used for a hands free telephone conversation.
⑧ [] key	● Temporarily places a call on hold.
⑨ [] key	● Allows you to monitor a call without using the handset. ● Press this key when making a hands free telephone conversation.
⑩ Number keys 0-9 # *	● These keys are used to dial fax and phone numbers and to change various functions.
⑪ [COPY] key	● Press to make a copy.
⑫ [START] key	● Press to start transmission or manual reception.
⑬ [STOP/C] key	● Press to interrupt transmission/reception/copying or to stop the ERROR indicator lighting. ● Press to cancel various setting and dialing functions and to remove an original document that has been placed in the unit.

Note: It is required that the PABX has a call transfer function using flash signal.

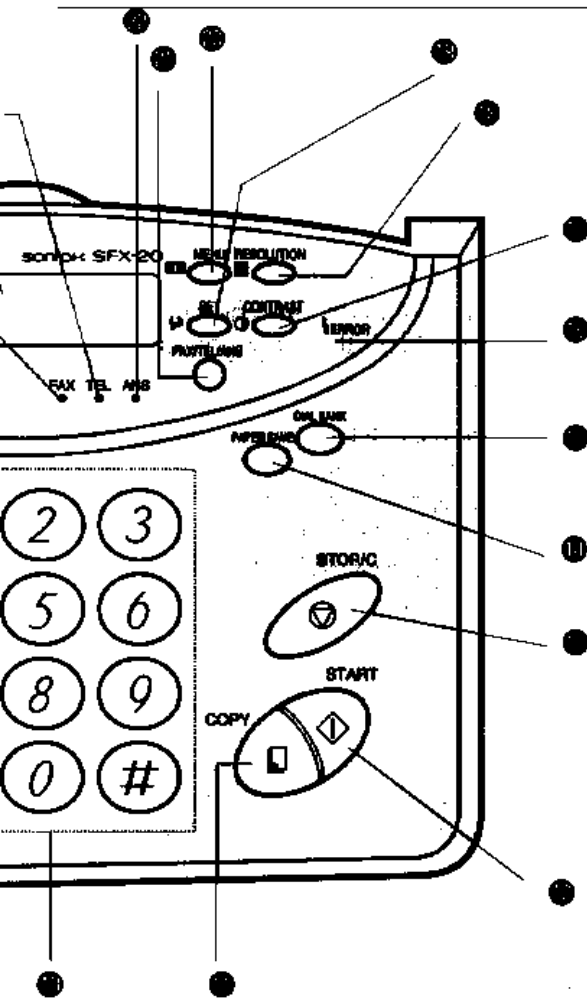

● [PAPER SAVE] key	● Press this key to set paper save feature. Lights when the unit set to paper save mode.
● [DIAL BANK] key	● Press this key to dial the number stored in dial bank memory.
● ERROR lamp	● Lights if a communication error occurs.
● [CONTRAST] key	● Press this key to select contrast settings.
● [RESOLUTION] key	● Press this key to select resolution settings.
● [SET] key	● Press this key to confirm selections.
● [MENU] key	● Press this key when selecting various functions.
● [FAX/TEL/ANS] key	● Press this key when setting receiving mode.
● ANS lamp	● Lights when the unit is set to answer reception mode.
● TEL lamp	● Lights when the unit is set to telephone reception mode.
● Display	● Shows calendar and clock functions, operation guidance, machine status, etc.
● FAX lamp	● Lights when the unit is set to fax reception mode.
● A/P lamp (Auto progress)	● Lights when the unit switches to auto progress mode. Auto progress mode: Transmission or reception starts automatically while it is performed manually by picking up handset or pressing  .

Telephone line and AC connections

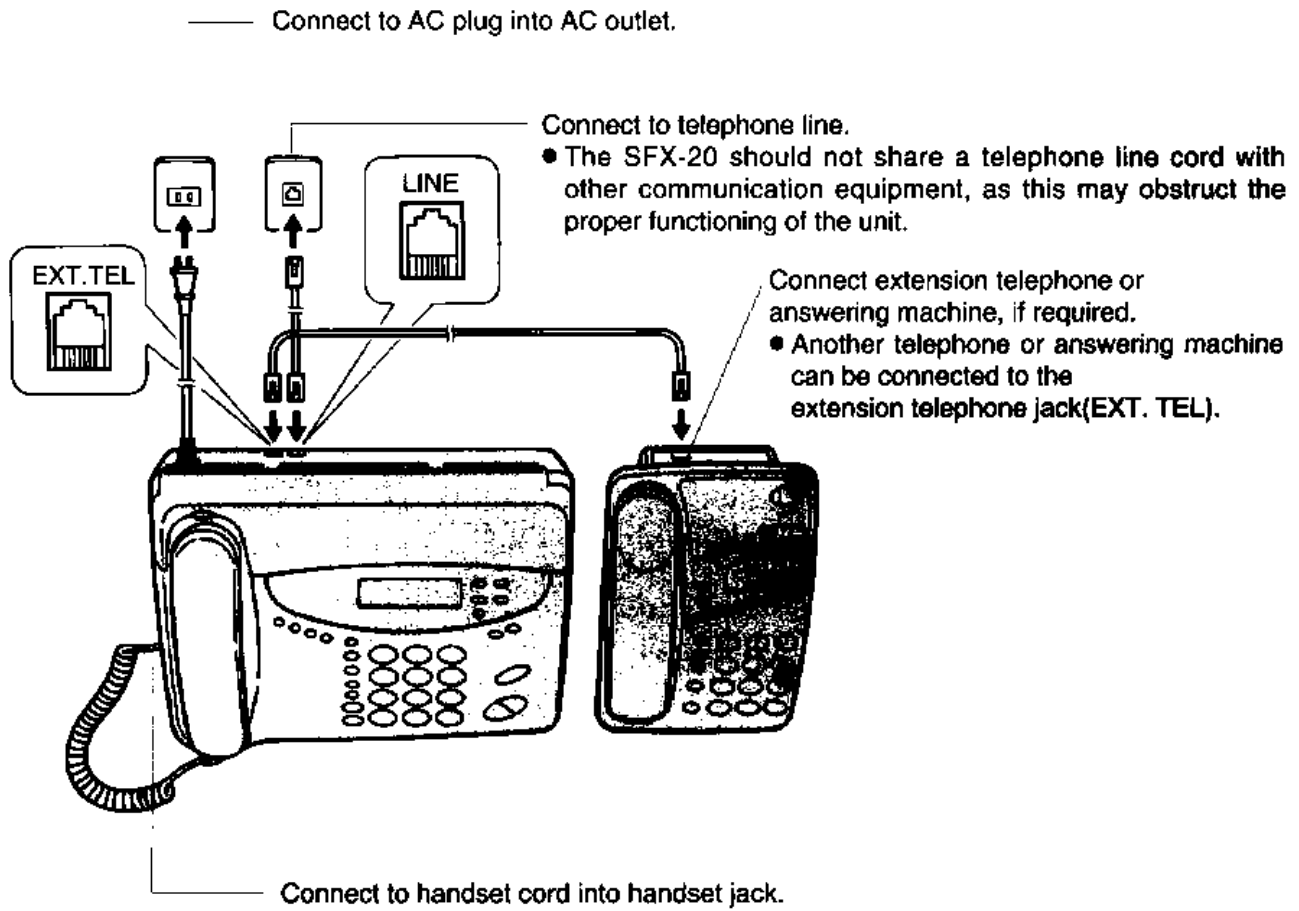

Setting the dialing mode switch

Set the dialing mode switch (DIAL) to the correct position for your telephone line.

Before use

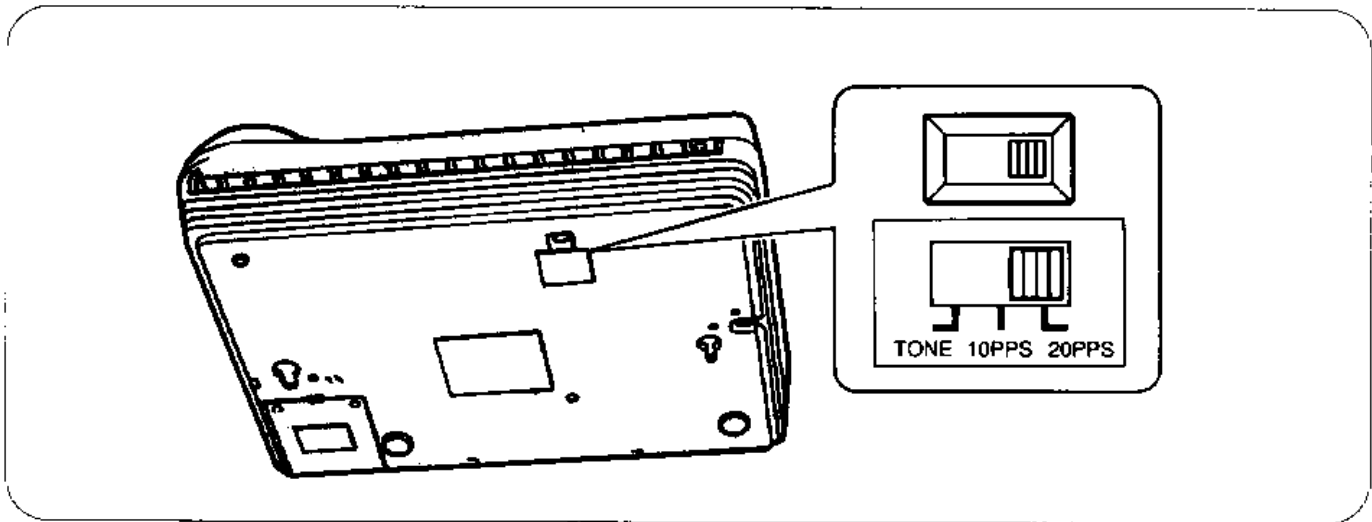

If you are not sure which dialing system your telephone is using, contact your telephone company.

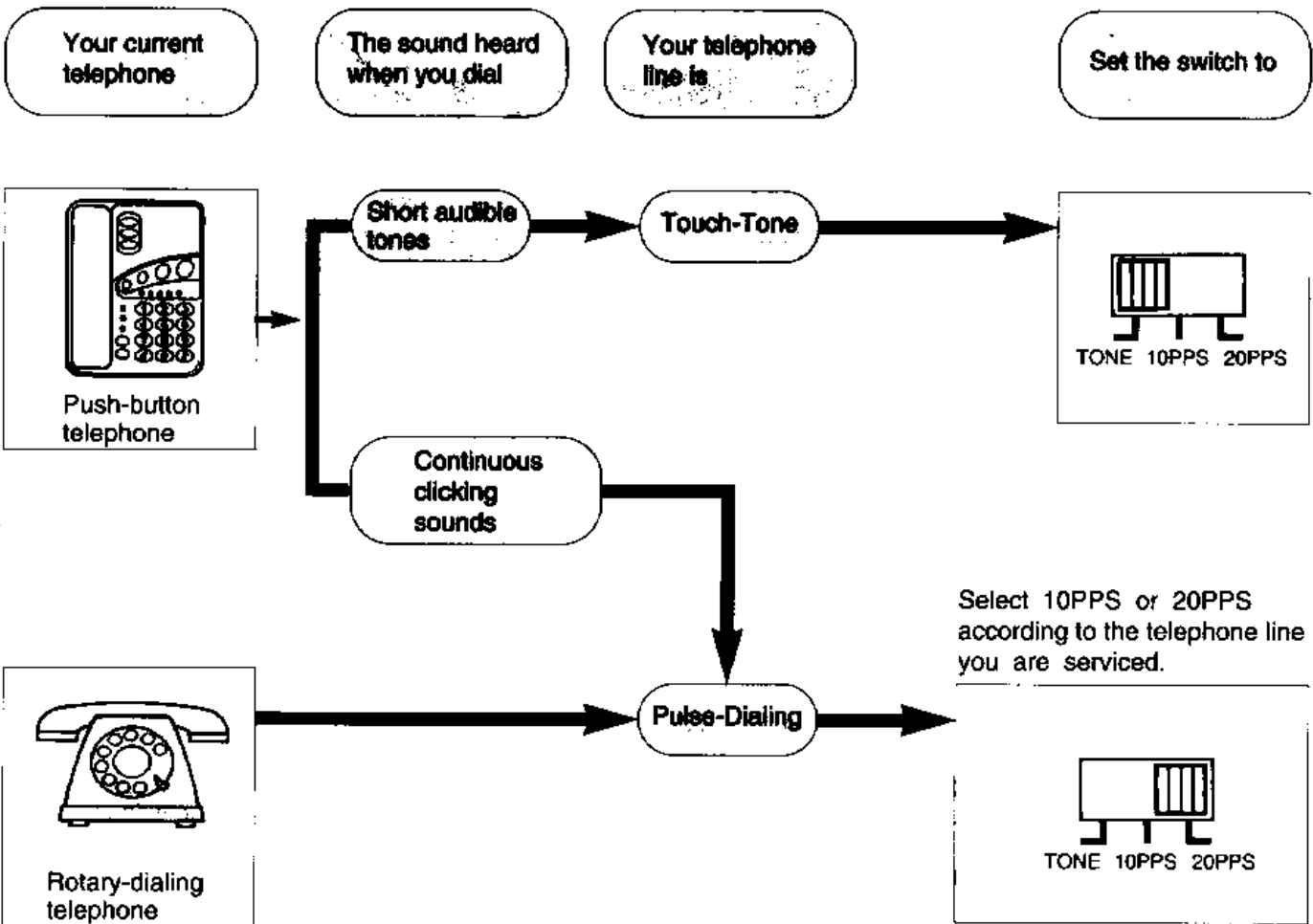

Recording paper

How to install the recording paper roll:

1. Open the recording paper cover.

- (1) Take off the handset.
- (2) Open the protective cover.
- (3) Lift the operation panel forward.
- (4) Press [OPEN] button.

2. Place the supplied roll, in the direction shown in the diagram, in the paper holder with both sides seated securely.

- Remove any slack from the roll.

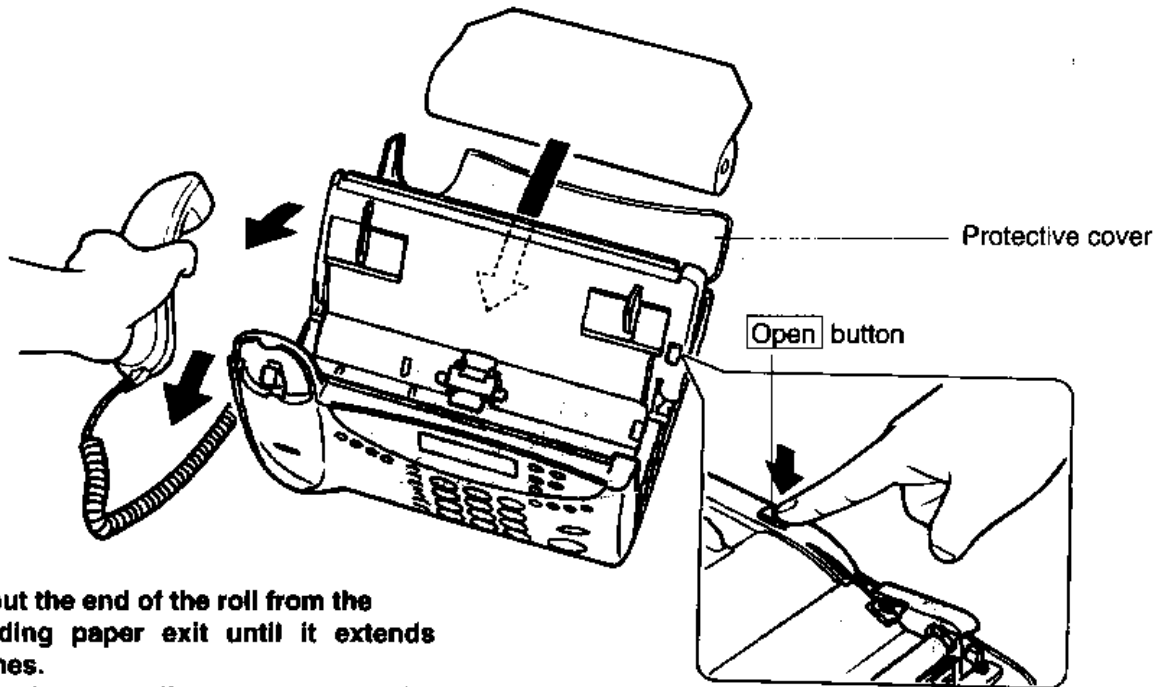

3. Pull out the end of the roll from the recording paper exit until it extends 4 inches.

Close the recording paper cover by pressing both left and right corners of the far end of the cover firmly.

4. Cut the extra recording paper. Replace the handset.



* Use only the recording paper specified for the SFX-20.

High-grade thermal paper

The SFX-20 is compatible with the high-grade thermal paper, a new type fax recording paper with plain-paper quality. Unlike regular thermal paper, the high-grade thermal paper does not fade with time, can be written on with pencil and can be erased.

SANYO Type: 3RE2182800450, 216 mm (8.5") wide and 25 m (82') long.

Thermal paper

SANYO Type: R-4079448-1, 216 mm (8.5") wide and 30 m (98') long.

To purchase, contact your dealer.

A 10-meter (32.8') long roll is supplied with your SFX-20.

Confirming proper operation (Copying)

Make a copy to confirm that the unit is operating properly.

1



Place the original document face down.
Adjust the paper guide to the width of the document.

STANDARD
NORMAL
STAND-BY

2

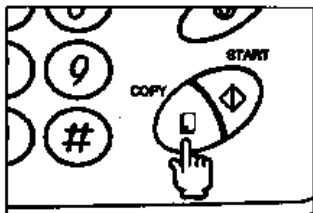

Press **COPY**.
To enlarge, reduce or reform a copy, see page 42.

STANDARD
NORMAL
ZOOM RATE ? 100%

3

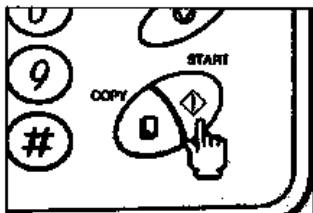

Press **START**.

STANDARD
NORMAL
*** COPY ***

4

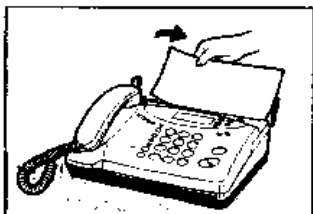

After copying is completed, cut the recording paper.

- For copying, the SFX-20 uses FINE or SUPERFINE resolution only. If the RESOLUTION key is set to STD, FINE setting is automatically used.

STANDARD
NORMAL
10 Jun. '94 12:00

Header print (Setting your station name and fax number)

Once you have programmed your station name and fax number into the SFX-20, this information is printed at the top of all faxes you send.

1

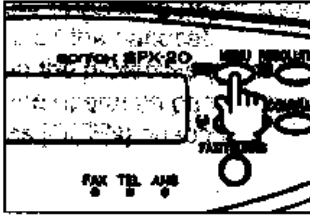

Press **MENU**.

STANDARD
NORMAL
1 : POLLING R x . ?

2

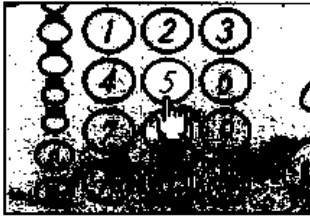

Press **5**.

STANDARD
NORMAL
5 : SET MODE ?

3



Press **SET**.

STANDARD
NORMAL
1 : TIME SET ?

4

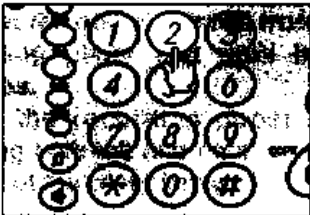

Press **2**.

STANDARD
NORMAL
2 : STATION CODE ?

5

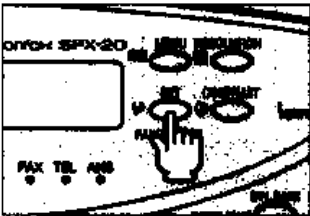

Press **SET**.

STANDARD
NORMAL
█ : A B C D E

6

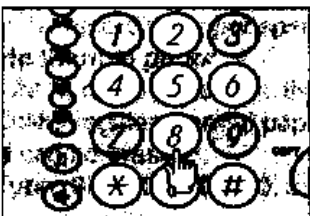

Enter your station name.
A maximum of 24 characters can be entered.
(See page 14 for detailed instructions.)

STANDARD
NORMAL
S F X 2 0 █ : 6 7 8 9 0



HOLD

7

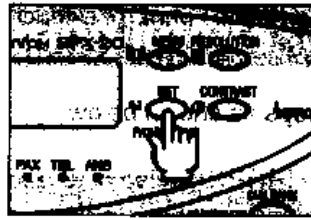

Press **SET**.

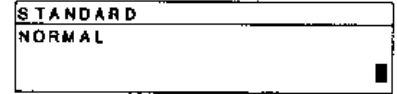

8

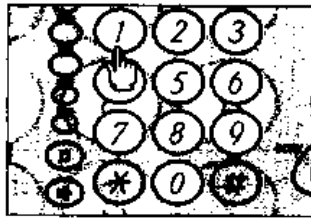

Enter your fax number.
Your fax number can be entered up to 20 digits in length.
Example: 123456

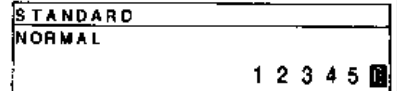

9

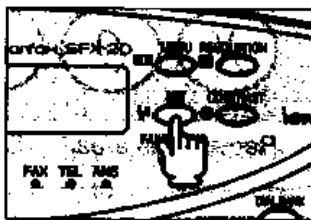

Press **SET**.



10

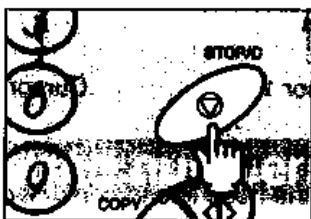

Press **STOP/C**.

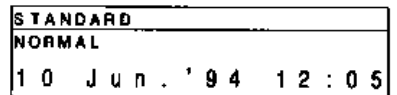

11

Print an activity report (See page 48) to make sure that your station name and fax number have been programmed correctly.

- To interrupt programming, press **STOP/C**.
- If you make a mistake in entering a fax number, press **STOP/C** and then re-enter the number.
- To enter a hyphen (-) between two digits, press **SPEED DIAL**.
- To enter a plus sign (+) preceding your fax number, press **HOLD**.
- The header can be printed either outside the original document (in the top margin) or inside the document itself. You can select the desired setting using feature switch No. 20 (see page 57). Default setting is printing outside of the original.

NOTE: If you choose to print the header inside the document, the top of the original document (about 1 cm) may not be reproduced.

Printing outside of the original.

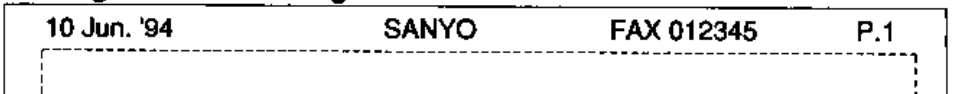

Printing inside of the original.

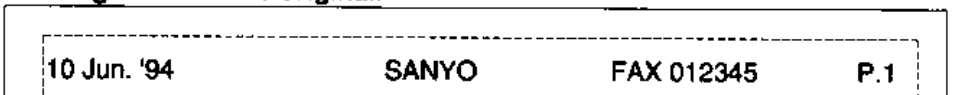

SPEED/DIAL
SET

MENU
STOP/C

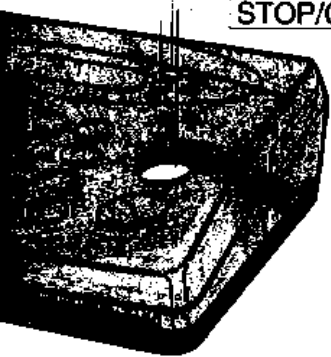

Entering names

You can enter the names when programming header print, one-touch dial and speed dial.

The usable characters are separated to 3 groups as shown below.

- To enter the names, use the keys 2, 4, 5, 6, 8, 0, * and # which are being light.

Group 1	Group 2	Group 3
ABCDE	abcde	12345
FGHIJ	fghij	67890
KLMNO	klmno	...:~
PQRST	pqrst	+/&*~
UVWXY	uvwxy	#""()
Z	z	<>!?=

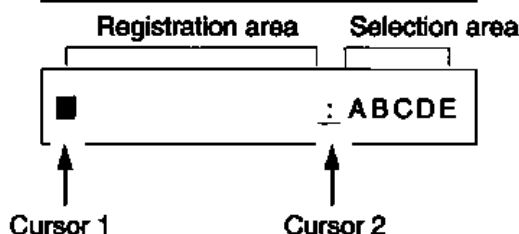
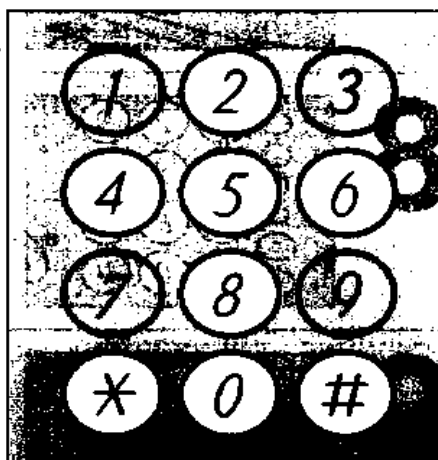

Character selection

- To select the character group, press [5].
Each time pressing [5], the display shows the head line of characters of each group.
- To change the character on the display among the group, press [8].
Each time pressing [8], the display shows the characters of next line.
(Each time pressing [2], the display shows the characters of previous line.)
- To move the cursor 2 to the right, press [6].
- To move the cursor 2 to the left, press [4].

Entering character

- To fix the character on the cursor 1, press [#] when desired character is shown on cursor 2.
The cursor 1 moves to the right..
- Only to move the cursor 1 to the right, press [#] when cursor 2 is positioned under colon (:).
- Only to move the cursor 1 to the left, press [*] when cursor 2 is positioned under colon (:).
- To erase the character and to make a space, press [0].



Entering letters

- Press **8** to select "PQRST".

Press **6** to move the cursor 2 to "S".

Press **#** to fix "S" and then the cursor 1 moves to the right.

STANDARD
NORMAL
S █ : P Q R S T
↑ cursor 1 ↑ cursor 2

- Press **8** to select "FGHIJ".

Press **#** to fix "F" and then the cursor 1 moves to the right.

STANDARD
NORMAL
S F █ : F G H I J

- Press **8** to select "UVWXY".

Press **6** to move the cursor 2 to "X".

Press **#** to fix "X" and then the cursor 1 moves to the right.

STANDARD
NORMAL
S F X █ : U V W X Y

Entering numbers

- Press **5** to select the character group 3.

Press **6** to move the cursor 2 to "2".

Press **#** to fix "2" and then the cursor 1 moves to the right.

STANDARD
NORMAL
S F X 2 █ : 1 2 3 4 5

- Press **8** to select "67890".

Press **6** to move the cursor 2 to "0".

Press **#** to fix "0" and then the cursor 1 moves to the right.

STANDARD
NORMAL
S F X 2 0 █ : 6 7 8 9 0

- If you make a mistake in entering a letter or number, simply press **#** to move the cursor right or ***** to move left to the appropriate space and then enter the correct letter or number.
- If the cursor 2 is at ":" position, **#** and ***** are only effect to move the cursor 1.
- If you interrupt the entering names operation about 1 minute, the display returns to stand-by mode. Operate from step 1 of the programming.

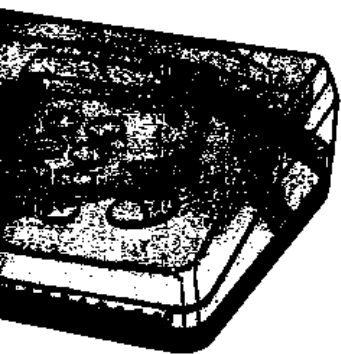

Calendar and clock

To set the date and the clock time.

1

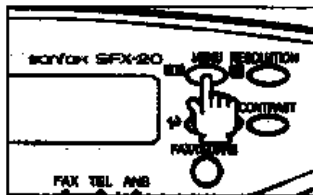

Press **MENU**.

STANDARD
NORMAL
1 : POLLING Rx. ?

2

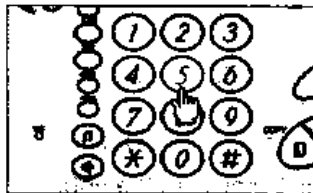

Press **5**.

STANDARD
NORMAL
5 : SET MODE ?

3

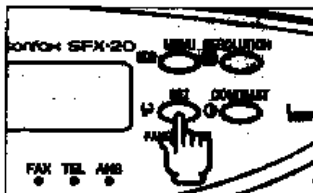

Press **SET**.

STANDARD
NORMAL
1 : TIME SET ?

4

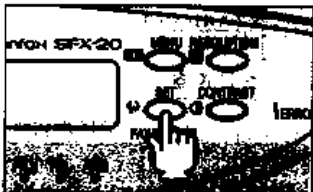

Press **SET** again.

STANDARD
NORMAL
0 0 6 . ' 9 4 1 2 : 1 0

5

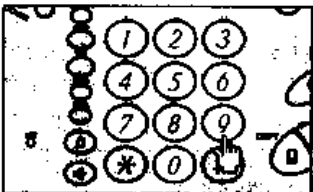

Enter the day, month, year and time using the number keys.

- The time must be entered using 24-hour system.
- The day, month and year should be entered in 2 digits each.

Example: to enter 23 June, 1994, 12:00, press **2, 3, 0, 6, 9, 4, 1, 2, 0** and **0**.

STANDARD
NORMAL
2 3 0 6 . ' 9 4 1 2 : 0 0

6

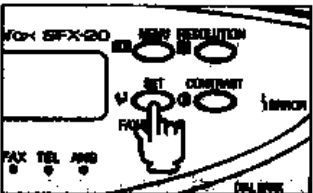

Press **SET**.

- To finish the setting, press **STOP/C**.

STANDARD
NORMAL
2 : STATION CODE ?

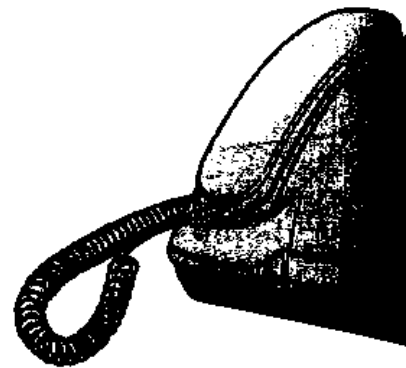

■ If you make a mistake, move the cursor to the appropriate place, then enter the correct number.

Press **#** to move the cursor right.

Press ***** to move the cursor left.

Phone calls

Making phone calls

1

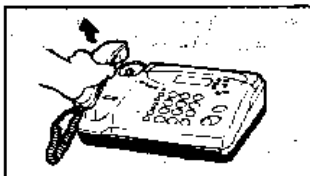

- Lift the handset.
 → The dial light turns on.
 ● You can hear the dial tone.

STANDARD
NORMAL
1 0 Jun . ' 9 4 1 2 : 0 0

2

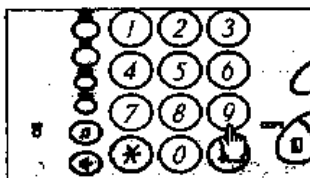

- Dial the number you want to call.
 ● The dial light turns off after 5 seconds you completed the dialing.

STANDARD
NORMAL
1 2 3 4 5 6 7 8 9

3

When the call is answered, talk.

STANDARD
NORMAL
1 2 3 4 5 6 7 8 9

4

Hang up after the conversation is completed.

STANDARD
NORMAL
1 0 Jun . ' 9 4 1 2 : 0 0

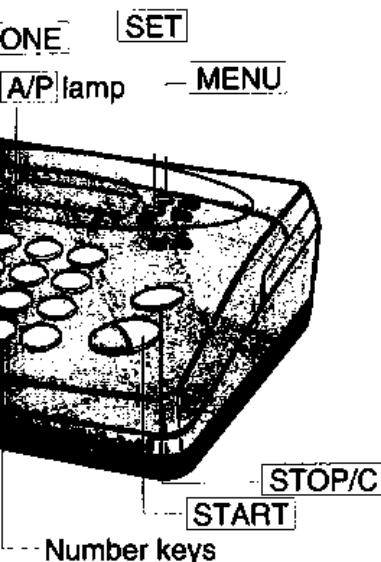

- If you need to switch from Pulse Dialing to Touch-Tone dialing temporarily when the PULSE/TONE switch is set to PULSE, press **TONE** in a dialing.
- To insert a pause between two digits in a number being dialed, press **PAUSE**.

Answering telephone calls

1

- The telephone rings.
 → The dial light blinks.

2

- Lift the handset and talk.
 → The dial light turns off at the same time of lifting the handset.

3

Hang up after the conversation is completed.

- If you hear an incoming fax tone when you lift the handset, replace the handset after the A/P(Auto Progress) lamp lights and the display shows RECEIVING. The SFX-20 receives the incoming fax automatically. If the reception is not initiated, press **START** to initiate reception.

Hold

1

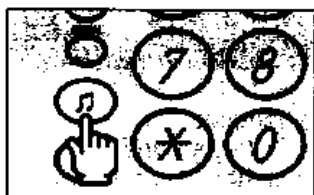

- Press  during a telephone call.
- ➔ The holding melody is released.
 - The dial light blinks.

STANDARD
NORMAL
*** HOLD ***

2

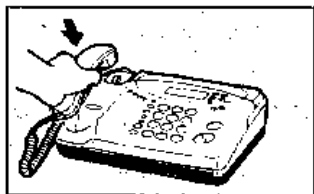

- Replace the handset.
- ➔ The call is on hold.

STANDARD
NORMAL
*** HOLD ***

3

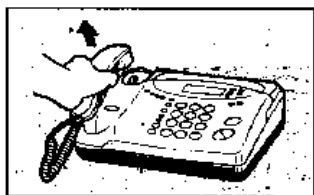

- Lift the the handset to continue the conversation.
- The dial light turns on and then turns off after 5 seconds you lift the handset.

- If you do not replace the handset at step 2, press  again to resume the conversation.
- If an extension phone is picked up while a call is on hold, the extension phone user can talk with the other party.
- The music-on-hold feature offers several musical choices. To select the music of your choices, set feature switch No. 10. (See page 57.)
The choices are: ● Silence(no music) ● MINUET ● GREENSLEEVES
(The factory preset default setting is GREENSLEEVES.)

Redial

The REDIAL key redials the last number dialed.

1

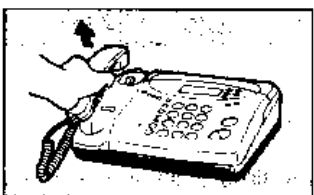

- Lift the handset.
- ➔ The dial light turns on.
 - You can hear the dial tone.

STANDARD
NORMAL
10 Jun. '94 12:00

2



- Press .
- ➔ The last number dialed is redialed.

STANDARD
NORMAL
1 2 3 4 5 6 7 8 9

3

Talk.

REDIAL

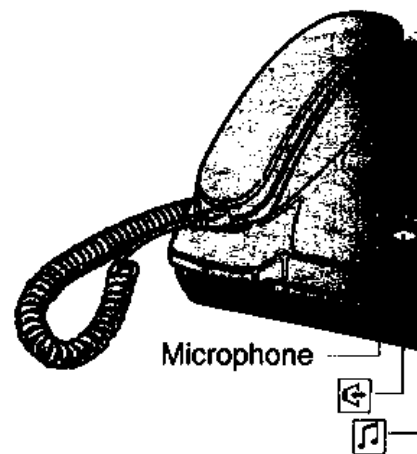

Hands free phone calls and conversation

You can make a telephone call and talk to the party you called without lifting the handset(hands free).

Making phone calls

1

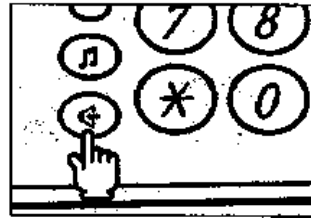

Press .

➔ You can hear the dial tone from the speaker.

●  light and the dial light turns on.

STANDARD
NORMAL
** HANDS FREE **

2

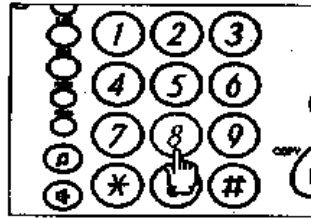

Dial the number you want to call.

● Use one-touch dial, speed dial and direct dial.

● The dial light turns off after 5 seconds you completed the dialing

STANDARD
NORMAL
9 8 7 6 5 4 3 2 1

3

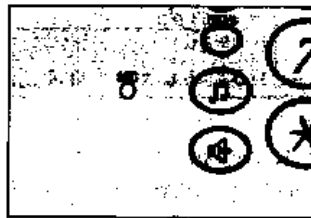

When the call is answered, speak to the microphone.

● Speak to microphone approx. 50 cm (20") away from.

4

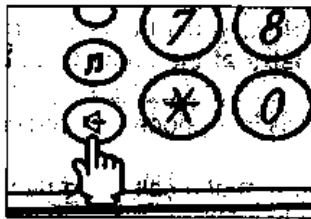

Press  when the conversation is completed.

●  light turns off.

STANDARD
NORMAL
10 Jun '94 12:00

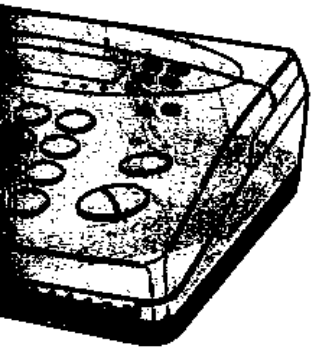

Answering telephone calls

1

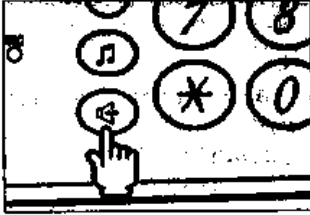

The telephone rings.
Press .

STANDARD
NORMAL
** HANDS FREE **

2

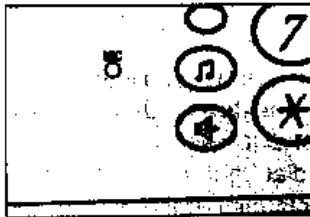

When the call is answered, speak to the microphone.

3

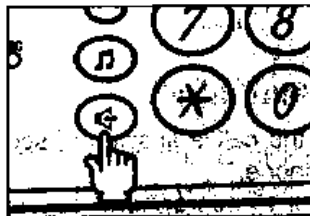



Press  when the conversation is completed.

STANDARD
NORMAL
10 Jun. '94 12:00

- If you hear an incoming fax tone at step 1, replace the handset after the A/P (Auto Progress) lamp lights and the display shows RECEIVING. The SFX-20 receives the incoming fax automatically. If the reception does not performed, press **START** to initiate reception.
- To perform hands free conversation smoothly, you'd better to start talking after the party stop talking. If each other talks at the same time, the voice from the speaker may not be heard.
- When you pick up the handset during a hands free phone call, you can talk to the other party using the handset.
- When you press  while you are making a phone call using handset, you can perform a hands free call. Replace the handset.

Note:

- Do not place the unit at noisy spot. If the unit is located noisy place, the hands free call is not performed smoothly.
- If the call is disconnected at the other party, the  key is not canceled automatically. To cancel, press .

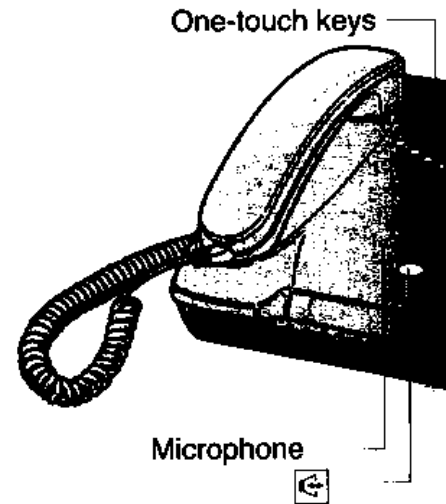

One-touch dial

The feature allows you to dial a stored number at the one-touch of a single button.

The one-touch keys can be performed hands free phone call automatically when no original is placed in the original slot.

Before one-touch dialing can be used, the phone numbers of the parties must be programmed into memory. A maximum of 4 one-touch dialing numbers can be stored in memory. (See page 49 for programming instructions.)

To place a call using one-touch dialing buttons:

1

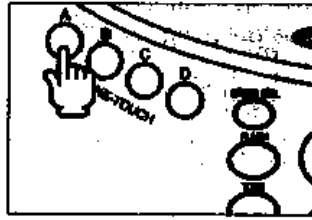

Press one-touch key (A-D) for the party you want to call.

→ The phone number programmed in the one-touch dialing memory is dialed out.

STANDARD
NORMAL
DEALER A

2

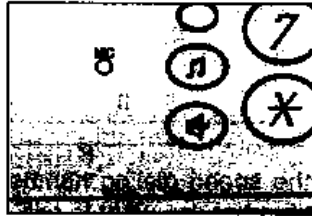

When the call is answered, speak to the microphone.

● Speak to microphone approx. 50 cm (20") away from.

STANDARD
NORMAL
** HANDS FREE **

3

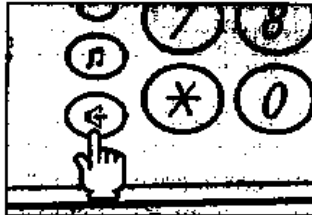

Press **STOP/C** when the conversation is completed.

STANDARD
NORMAL
10 Jun. '94 12:00

■ If you make a mistake when pressing one-touch key, press **STOP/C**, then operate from the first step.

■ When you pick up the handset at step 2, you can talk with the other party using the handset.

/P lamp

STOP/C

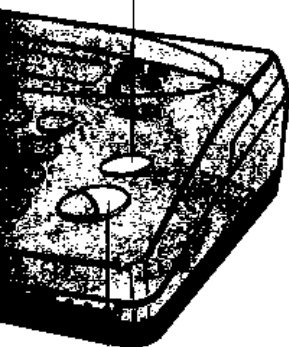

START

Speed dial



This feature allows you to place a call without dialing the entire number. Before speed dialing can be used, the phone numbers of the parties must be programmed into memory. A maximum of 20 speed dialing numbers can be stored in memory. (See page 49 for programming instructions.)

To place a call using speed-dialing:

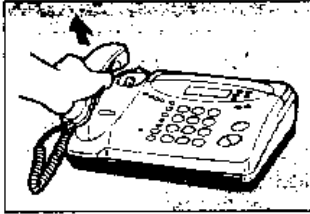
1



Lift the handset (or press )

- The dial light turns on.
- In case pressing ,  light turns on.

STANDARD
NORMAL
10 Jun. '94 12:00

2

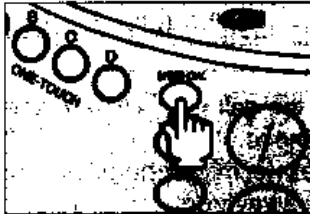

Press **SPEED DIAL**.

STANDARD
NORMAL
S . D : ■

3

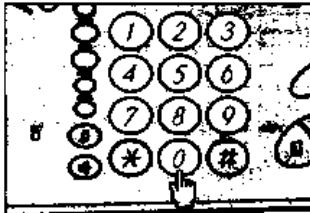

Enter the speed dialing number (01-20) for the number you want to call.

- ➔ The phone number programmed in the speed dialing memory is dialed.

STANDARD
NORMAL
DEALER B

4

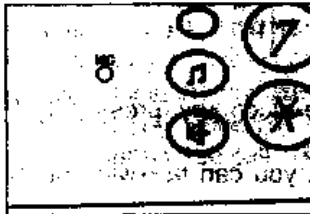



When the call is answered, talk.

- In case pressing  at step 1, speak to microphone approx. 50 cm (20") away from.

5



When the conversation is completed, replace the handset.

- In case pressing  at step 1, press  again.

STANDARD
NORMAL
10 Jun. '94 12:00

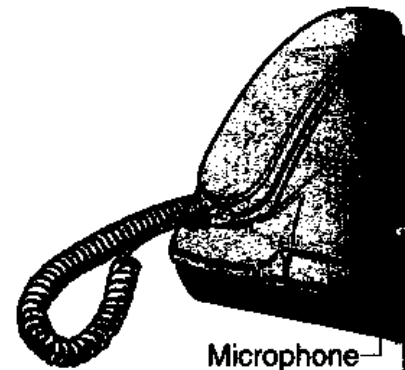

Microphone

- If you make a mistake when pressing speed dial number, press **STOP/C**, then operate from the first step.

Dial bank

Frequently dialed numbers using number keys can be stored (up to 20 numbers) in memory automatically.

Each time pressing **DIAL BANK**, the display shows the numbers from the most frequent dialed number.

To place a call using dial bank

1

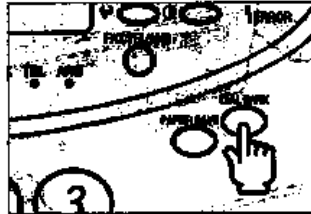

Press **DIAL BANK** to select the number you want to call.

STANDARD
NORMAL
9 8 7 6 5 4 3 2 1

2

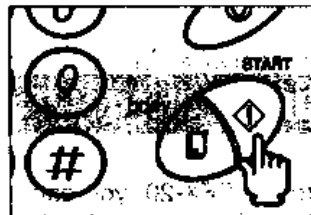

Press **START**.

➔ light turns on and the unit begins dialing.

STANDARD
NORMAL
** HANDS FREE **

3



When the call is answered, lift the handset and talk, or speak to the microphone.

STANDARD
NORMAL
10 Jun. '94 12:00

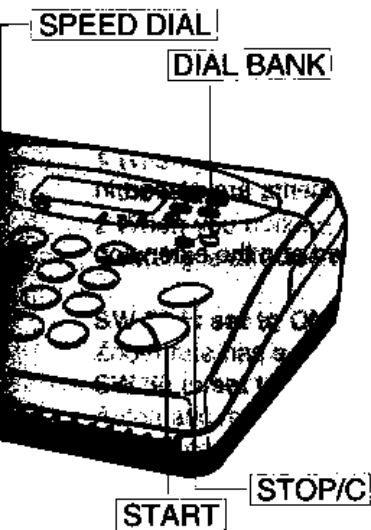

- The stored number in the dial bank can be transferred to one-touch or speed dial. (See page 66.) In this case, the party's name can be added to the telephone number, if required. (See page 66.)
- When the party's name you dialed is shown on the display during transmission, it is automatically stored in the dial bank in stead of the telephone number.
- A maximum 16 characters (party's name) or 32 digits (telephone number) can be stored in the dial bank.

Extension telephone/answering machine

An answering machine or extension phone can be connected to the EXT. TEL jack on the rear of the unit.

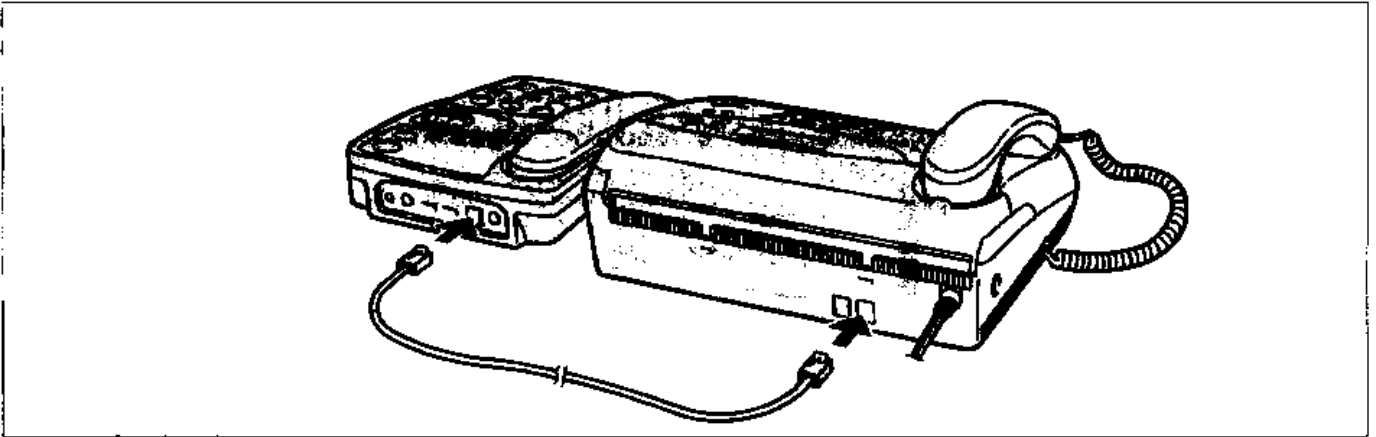

Answer reception mode

When an answering machine is connected to the SFX-20, you can set the SFX-20 to receive both voice and fax messages while you are away. (See page 35 and 38 for more details.)

Remote reception

You can switch the SFX-20 to fax reception mode from the connected extension phone if a caller wants to transmit a fax after a telephone conversation. (See page 39.)

- You can also use the connected extension phone to place a phone call when original documents are placed in the original slot for timer transmission. (See page 52.)
- If an extension phone is picked up while a call is on hold at the unit, putting on hold is canceled and the extension phone user can talk with the other party.
- When the AC cord is disconnected, the extension phone can be used.
- The connected extension phone and the unit can not be used at the same time.
- If you have initiated the call from the extension phone, remote reception will not work.

Original documents

■ Transmittable original size

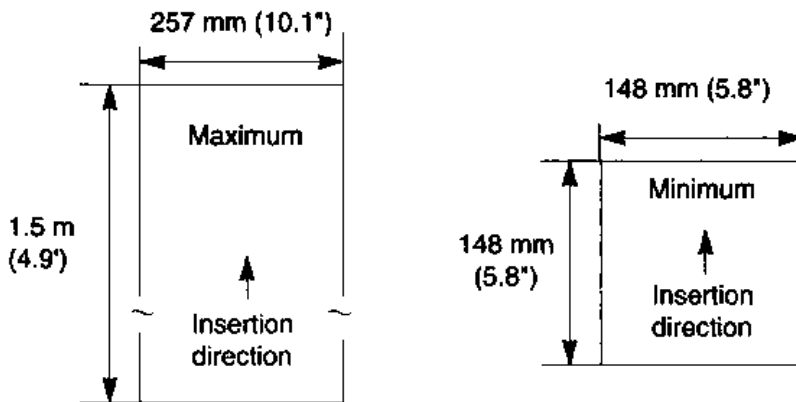

■ Effective text width

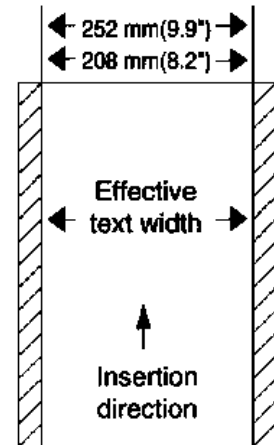

Note: An original other than specified should be reduced or enlarged by the photo copier then the copy can be used as an original.

■ Effective thickness

	1 original sheet	multi sheets
thickness (per sheet)	0.05-0.15 mm (0.002"-0.006")	0.08-0.13 mm (0.003"-0.005")

Automatic reduction

This feature is carried out in such a manner.

1. When you send a B4 width of document and the receiver's recording paper is A4, the sending machine reduces the width of document from B4 to A4 automatically.
2. When you make a copy of B4 document while A4 recording paper is set, the feature switch (No. 50) of zoom copy setting is affected as follows.

SW 50 is set to ON

Zoom rate has a priority and the copy is carried out according to the zoom rate set by **[MENU]**.

SW 50 is set to OFF

Automatic reduction is carried out.

So, the copy of B4 width of document is reduced to A4.

■ Notes on the suitability of documents:

- Allow ink and/or glue to dry completely before inserting a document.
- Do not transmit curled or folded documents.
- Make sure that any paper clips, staples or pins have been removed from documents.
- When an original is carbon paper, waxed paper or vinyl-coated paper, use a photocopy of the original.
- Never use documents thicker than 0.15 mm (0.006"), metal sheets or cloth. Use a photocopy instead.

Contrast/Resolution

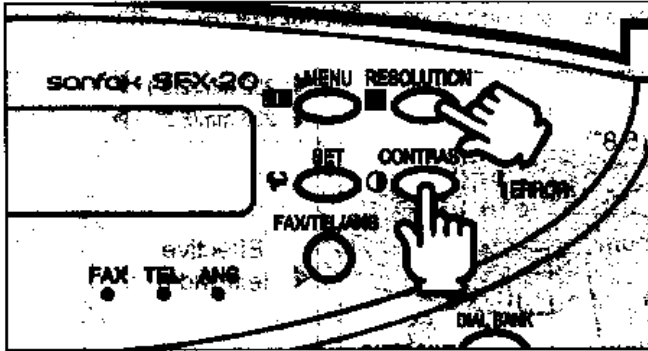

The SFX-20 allows you to select different contrast/half-tone and resolution modes for fax transmission and copying. Select the most suitable mode for your original documents after placing the documents in the original slot.

You can also set the SFX-20 either to remain in the selected mode until another selection is made, or to return to the default mode after each transmission/copying. Use the feature switch No. 27 and 28 to switch between **Not return** and **Return home** modes. (See page 57.) The initial factory setting is **Not return** position.

● CONTRAST

NORMAL

For normal contrast documents.



LIGHT

For low contrast documents.



HALF TONE

For transmitting or copying halftone documents (photographs, for example).
When HALFTONE is selected, the resolution mode is automatically set to FINE.

● RESOLUTION

STANDARD

For text in standard typefaces.



FINE

For text with fine type and for drawings.



SUPER FINE

For text with very small characters and/or graphics. The superfine communication is possible only with Sanyo fax models with superfine feature and non-Sanyo models that have ITU-T standard superfine feature.

Placing original documents

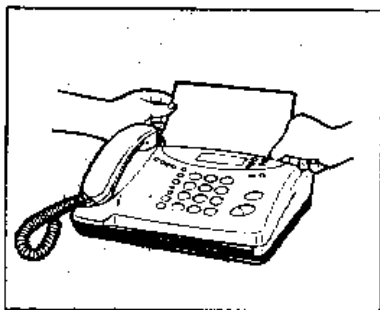
**1**

Open the protective cover.

2

Adjust the paper guide to the width of the document.

3

Place the document face down between the guides and gently insert it in the original slot. The document advances slightly.

Manual dialing transmission

1  Place the original document face down. Adjust the paper guide to the width of the document. (Max. 5 sheets.)

STANDARD
NORMAL
STAND-BY

2  Select a contrast/resolution mode if necessary. (See page 26.)

FINE
NORMAL
STAND-BY

3  Lift the handset and dial the number.

FINE
NORMAL
1 2 3 4 5 6 7 8 9

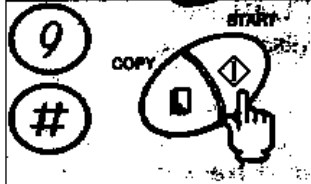
4  After the conversation, press **START**.
 ➔ The SFX-20 switches to transmission mode, transmission begins.

FINE
NORMAL
** TRANSMISSION **

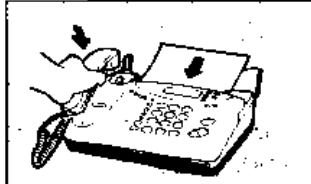
5  Replace the handset.

FINE
NORMAL
1 2 3 4 5 6 7 8 9

- If you hear a receiving fax tone before pressing **START** at step 4 and A/P(Auto Progress) lamp lights, replace the handset after the display shows TRANSMISSION. The SFX-20 transmits the original document automatically.
- Press **STOP/C** to interrupt a transmission or to remove a document set for transmission.
- If you make a mistake when entering a phone number, press **STOP/C**, then enter the correct number.

Transmission report

When a fax transmission is completed, the SFX-20 can print out a transmission report showing the other party's name or phone number, the number of the transmitted originals and the transmission result.

The automatic transmission report printout has been factory-set to the OFF (non-issue) position. To change the setting to ON(after each transmission) or ON(when an error occurs), use the feature switch No. 31. See page 57.

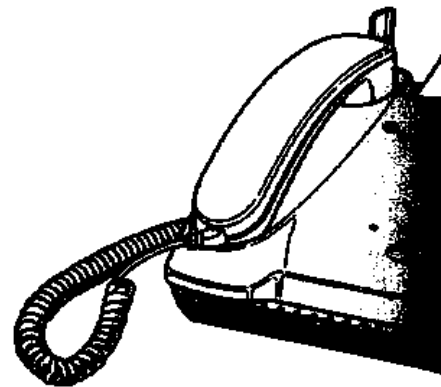

Automatic dialing transmission

1

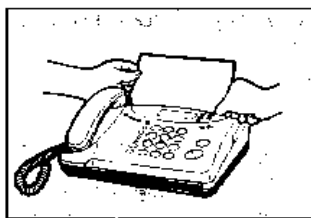

Place the original document face down.
(Max. 5 sheets.)

STANDARD
NORMAL
STAND-BY

2

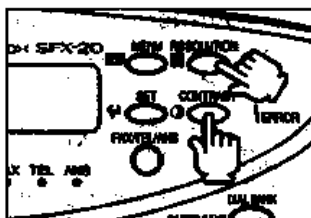

Select a contrast/resolution mode if necessary. (See page 26.)

FINE
NORMAL
STAND-BY

3

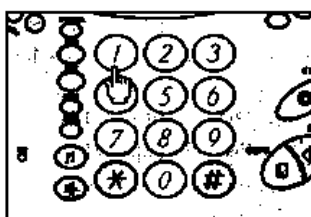

Dial the number using the number keys.

FINE
NORMAL
1 2 3 4 5 6 7 8 9

4

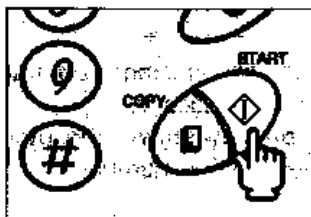

Press **START**.
➔ When the line is connected, transmission begins automatically.

FINE
NORMAL
** TRANSMISSION **

- Press **STOP/C** to interrupt a transmission or to remove a document set for transmission.
- If you make a mistake when entering the number, press **STOP/C**, then enter the correct number.

A/P lamp
CONTRAST
RESOLUTION

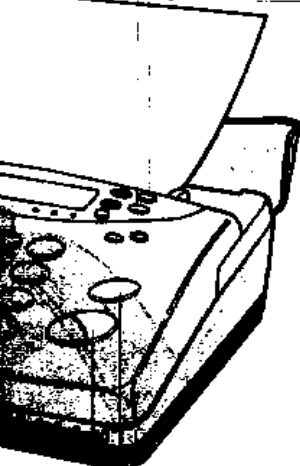

STOP/C

START

One-touch dialing transmission

1

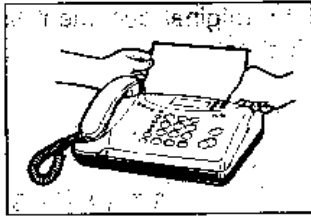

Place the original document face down.



2

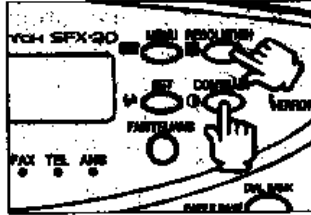

Select a contrast/resolution mode if necessary. (See page 26.)



3

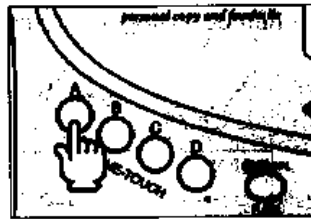

Press the one-touch key (A-D) for the party you want to send a fax to.

- ➔ Dialing starts.
- The stored party's name in the one-touch button is displayed.

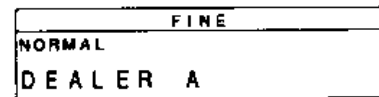

4

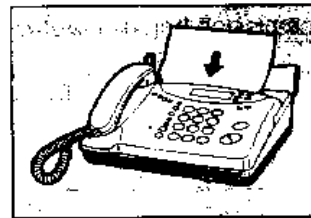

When the line is connected, transmission begins automatically.

- The display shows the other party's name or phone number.

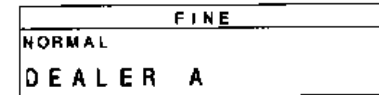

- For detailed instructions on programming one-touch dial numbers, see page 49.
- Press **[STOP/C]** to interrupt a transmission or to remove a document set for transmission.
- If you make a mistake when pressing one-touch key, press **[STOP/C]**, then enter the correct number.

One-touch keys

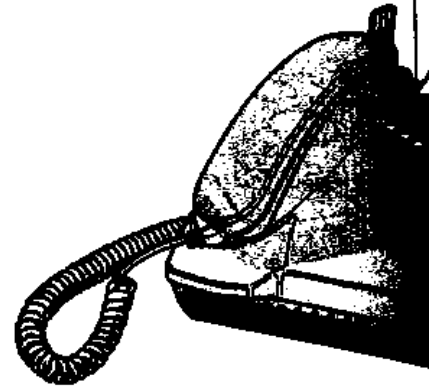

Speed dialing transmission

1



Place the original document face down.



2

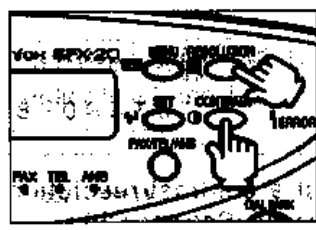

Select a contrast/resolution mode if necessary.
(See page 26.)



3

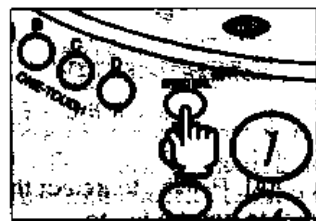

Press **SPEED DIAL**.

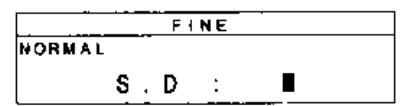

4

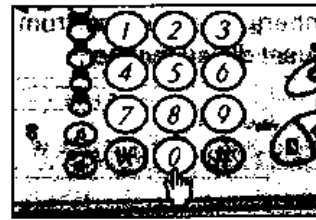

Press the speed dial number (01-20) for the party you want to send a fax to.
➔ When the line is connected, transmission begins automatically.

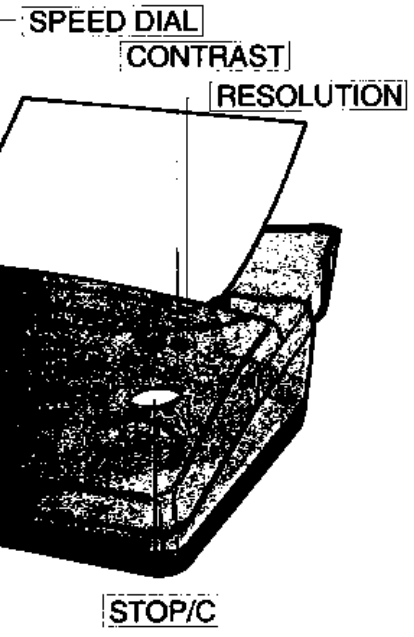
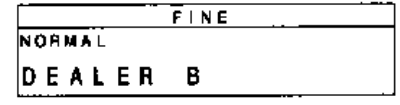

- For detailed instructions on programming speed dial numbers, see page 49.
- Press **STOP/C** to interrupt a transmission or to remove a document set for transmission.
- If you make a mistake when entering a speed dial number, press **STOP/C**, then enter the correct number.

asn ye-1

Dial bank

Frequently dialed numbers using number keys can be stored (up to 20 numbers) in memory automatically.

Each time pressing **DIAL BANK**, the display shows the numbers from the most frequent dialed number.

1

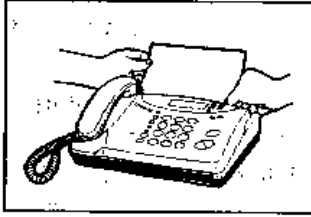

Place the original document face down.

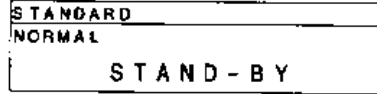

2

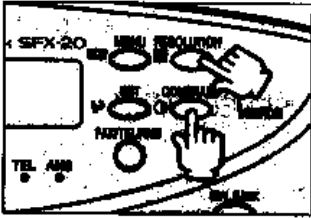

Select a contrast/resolution mode if necessary. (See page 26.)



3

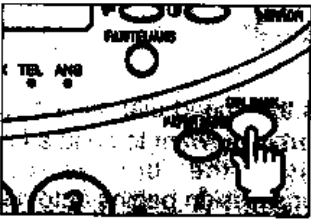

Press **DIAL BANK** to select the number you want to send a fax to.

• The display shows the max. 20 numbers in sequence from the most frequent dialed number.

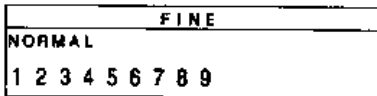

4

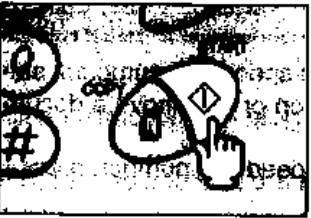

Press **START**.
➔ Dialing begins.

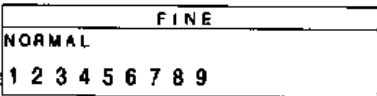

5

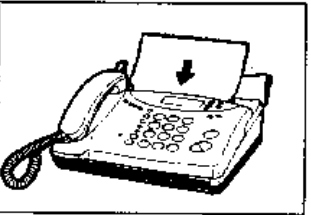

When the line is connected, transmission begins automatically.

- The stored number in the dial bank can be transferred to one-touch or speed dial. (See page 66.) In this case, the party's name can be added to the telephone number, if required. (See page 66.)
- When the party's name you dialed is shown on the display during transmission, it is automatically stored in the dial bank in stead of the telephone number.
- A maximum 16 characters (party's name) or 32 digits (telephone number) can be stored in the dial bank.

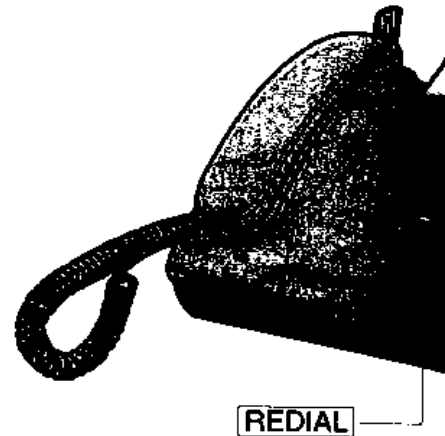

Redial

If a number that has been dialed (using manual dialing, one-touch/speed dialing, dial bank, polling reception or timer transmission) is busy, the SFX-20 automatically redials. You can also redial manually by pressing the **REDIAL** key.

Automatic redial

The dialed number is automatically redial. (If the document has been removed, automatic redialing is canceled.)

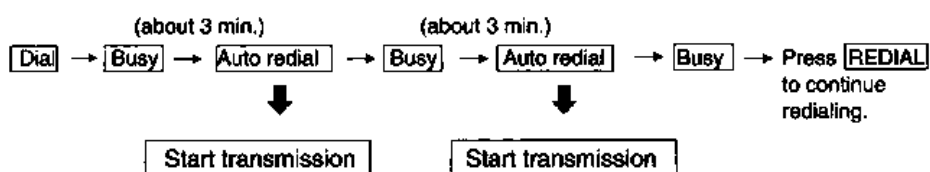

- The SFX-20 is set to redial a number twice (three times for a number dialed using the timer transmission feature). These settings can be changed using the feature switches No. 05 and 06. (See page 57.)
- Display shows:

Automatic redial
(Normal transmission)

WAITING REDIAL

(Timer transmission)

< TIMER Tx . 17 : 00 >

Manual redial

- 1 Press **REDIAL**. The number is redialed.
(If the document is removed, place the original document again.)

STANDARD
NORMAL
1 2 3 4 5 6 7 8 9

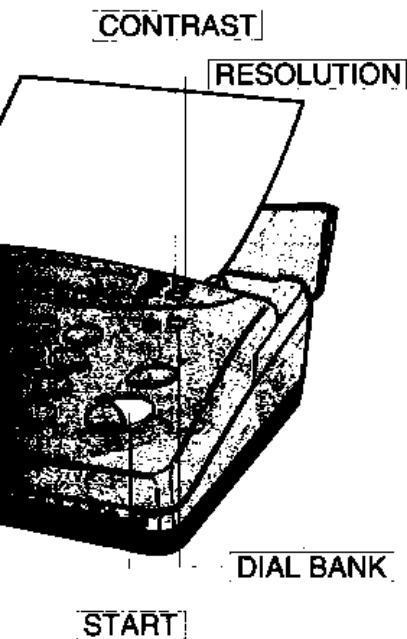

Overseas transmission

If you transmit the original document to overseas parties, the error condition may occur under the bad phone line situation. In this case, use this overseas transmission mode.

1



Place the original document face down.

STANDARD
NORMAL
STAND-BY

2

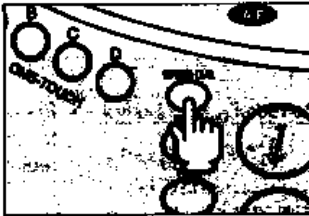

Press **SPEED DIAL**.

STANDARD
NORMAL
S . D : ■

3

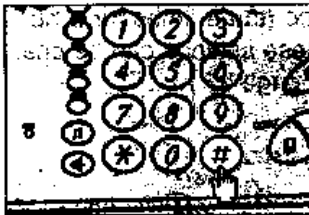

Press **#**.
 → A beep sounds.

STANDARD
NORMAL
4 8 0 0 B P S SET

SPEED DIAL

4

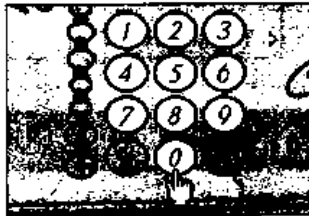

Enter the fax number.
 • Use Number keys, One-touch/Speed dial or Dial bank.

STANDARD
NORMAL
1 2 3 4 5 6 7 8 9

5

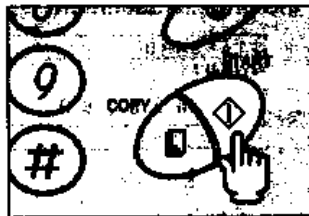

Press **START**.
 → When the line is connected, transmission begins automatically.

STANDARD
NORMAL
1 2 3 4 5 6 7 8 9

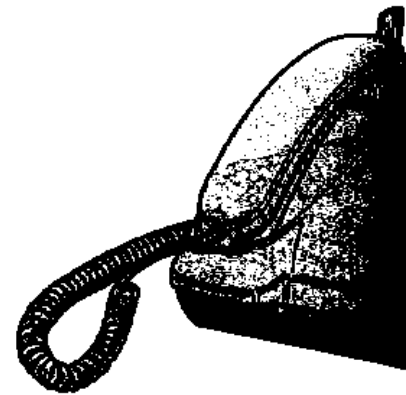

- This function setting is effective only one transmission.
- To cancel this function before transmitting, press **STOP/C** to remove inserted document. Once the inserted document is removed, overseas transmission is canceled.

Reception

Reception modes

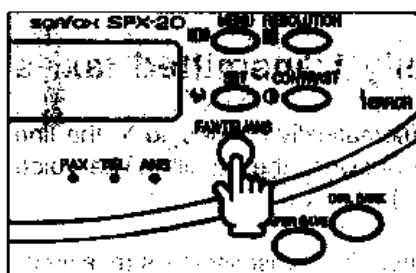

The SFX-20 provides 3 reception modes: FAX, TELEPHONE and ANSWER.

Set the **FAX/TEL/ANS** key to select the reception mode.

FAX

The SFX-20 receives incoming fax messages automatically without ring. Incoming telephone calls are received by the built-in phone and connected extension phone (if any).

The telephone and the SFX-20 both ring 5 times. You can change this number from 0-11 times by using the feature switch No. 09. (See page 57.)

TEL

Use this mode if you use the SFX-20 mainly for phone calls.

You can receive an incoming fax message after completing a phone conversation.

ANSWER

Use this mode if you expect both phone calls and faxes while you are away.

Incoming phone calls are received by the built-in handset (and connected answering machine).

Incoming faxes are received by the SFX-20 automatically.

See the next 3 pages for more details of each reception mode.

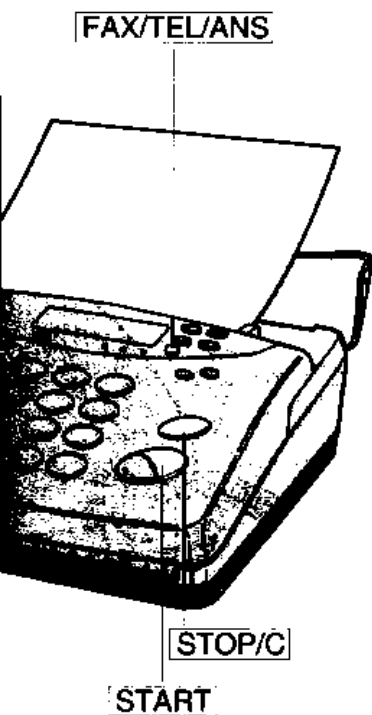

Fax reception mode

When an automatically transmitted fax is received:

Incoming faxes that are automatically transmitted are received automatically without ring.

When a phone call or manually transmitted fax is received:

A voice call or manual fax transmission is automatically connected to the line without ring and the built-in voice response answers the caller. (The voice response can be turned off. See note 1 below.)

Here's what happens when a voice call or manual fax transmission is received:

Incoming call.

As soon as the line is connected, the voice response 1 is heard.

<Voice response 1>

"Please wait for a moment."

The caller is billed for the call.

After this voice response, the SFX-20 rings 5 times. (See note 2 below.) You can talk to the party when you pick up the handset during the SFX-20 is ringing.

If the telephone is not picked up, voice response 2 is heard.

<Voice response 2>

"No one is here now, however if you wish to send a fax, please transmit at the tone."

The SFX-20 automatically switches to the fax receiving mode after the voice response.

Notes:

1. Using the feature switch No. 16, you can switch the voice response on or off. (See page 57.) If this switch is set to 00, no voice response will be heard.
2. The number of rings that sound after the line is connected can be changed to no rings (position 00) or any number 3-11 rings. Use the feature switch No. 09. (See page 57.)
If this switch is set to 00 (no rings), you can not receive the voice calls.

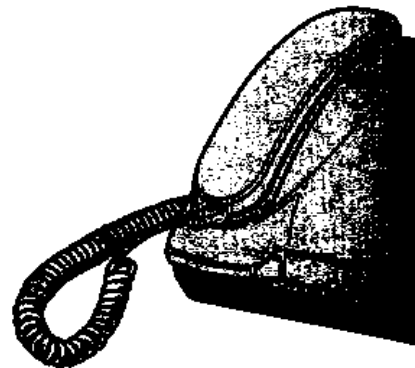

Telephone reception mode

Use this mode if you use the SFX-20 mainly for phone calls.
You can receive an incoming fax message when a phone conversation ends.

1



The telephone rings.
(See note 1 below.)
Lift the handset.

2

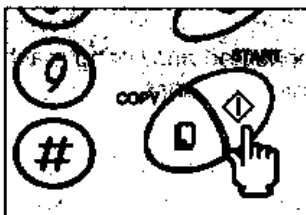

When the conversation is complete,
press **START**.
● Your caller can start fax transmission
after hearing a fax tone.

3



Replace the handset.

STANDARD
NORMAL
*** RECEIVE ***

4



When reception is complete, a beep
sounds.

STANDARD
NORMAL
10 Jun. '94 12:00

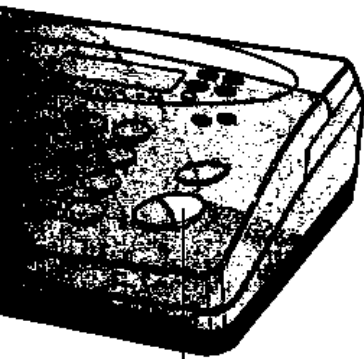

START

Notes

- The number of rings has been factory-set to 00 (unrestricted).
The number can be changed 7-15 rings by using the feature switch No. 07.
(See page 57.)
If you set the switch to 01-05 (7-15 rings), the SFX-20 switches to the receiving mode after the rings.
- If you hear an incoming fax tone when you pick up the handset, replace the handset after the display shows RECEIVING and A/P (Auto Progress) lamp lights.
The SFX-20 receives the incoming fax automatically.
- If you set the feature switch No. 07 to 02-05 (9-15 rings), SFX-20 may not receive the incoming fax transmission automatically, because the transmitter exceeds the time limit (waiting time of the receiver's response).

Answer reception mode

Use this mode if you want to receive both phone messages and faxes while you are away. (Connect an answering machine to the EXT. TEL jack on the rear side of the SFX-20.)

1

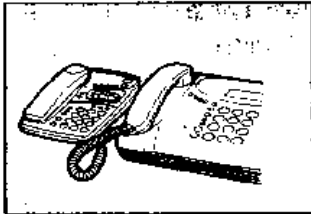

The telephone rings according to the ring delay setting of your answering machine.

2

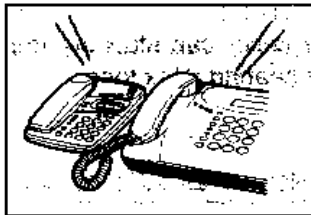

The connected answering machine plays your announcement.

3



When an incoming fax signal is received:

The SFX-20 automatically switches to the receiving mode.



When a phone call is received:

- The SFX-20 can receive a fax after the answering machine plays the announcement if the caller is trying to send a fax manually.
- Be sure to advise callers in your announcement that fax transmission takes place by transmitter's operation. Example: If you need to send a original document, please begin fax transmission.
- If there is no voice signal for 6 seconds, the SFX-20 automatically switches over to the fax receiving mode and sends a fax signal to the caller.

■ The answering machine must be set to answer a call within 10 rings. (If the telephone is allowed to ring more than 11 times, the SFX-20 switches to fax receiving mode.)

■ Automatic switching may not function properly on certain answering systems.

■ When the SFX-20 is set to the ANSWER mode, there may be some difficulties in remote message retrieval operation of the connected answering machine.

If you need to access the answering machine by remote, the SFX-20 must be set to the TEL mode.

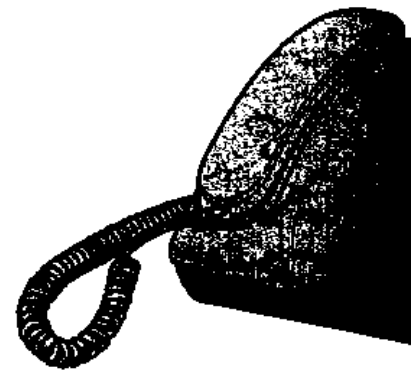

Remote reception

The remote reception feature allows a fax reception after a telephone call is answered by an extension telephone connected to the SFX-20.

The remote reception features are initially set to ON (remote activation number 33) position. You can change the setting ON (remote activation number 10-99) or OFF (no remote reception possible) using the feature switch No. 08. (See page 57.)

1



The telephone rings.
Lift the handset of extension phone.

2



After the conversation or when you hear the incoming fax tone, enter [3] twice on the extension phone to activate a fax reception.
➔ The SFX-20 switches to the receiving mode.

3



Replace the handset of extension phone.

ANS lamp

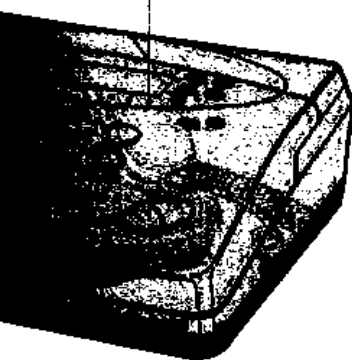

- When you make a mistake in entering the remote activation number, re-enter the correct number.
- If you initiated the call from the extension phone, remote reception will not work.
- Remote reception may not function properly on certain telephones.

Paper-save reception

Once this feature is set, the images of all received faxes are automatically compressed in length 50% or 75%, so less recording paper is used.

The compression ratio (50% or 75%) can be selected using the feature switch No. 55 (See page 57.)

The factory-set position is 50%.

To set paper-save reception

1

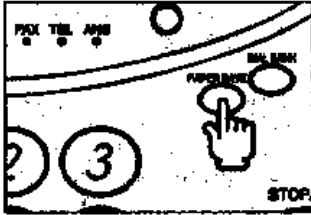

Press **PAPER SAVE**.

→ **PAPER SAVE** light turns on.

■ To turn off the paper-save function, press **PAPER SAVE** again.

→ **PAPER SAVE** light turns off.

■ This feature is effective only when the original document is transmitted in the STANDARD resolution mode with NORMAL or LIGHT contrast mode.

■ This feature is not effective for copying.

■ The copy received in the paper-save mode can be reformed to its original document size. (See reform copy on page 42.)

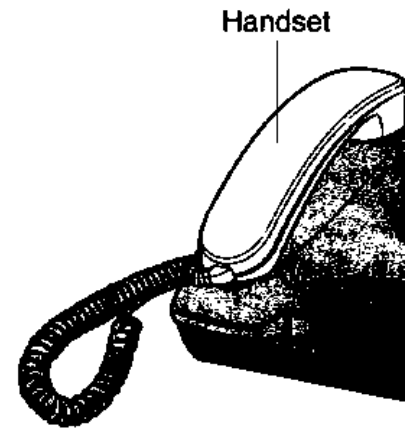

Phone reservation

The feature allows you to start a phone conversation after sending or receiving a fax.

To start a phone conversation after sending or receiving a fax:

1

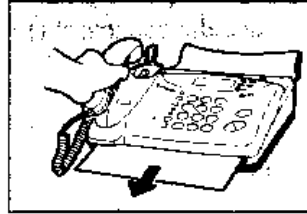

Lift the handset during fax reception or transmission.

- ➔ When the fax reception (or transmission) is completed, a beep sounds at the other side.
- In case of transmission, a beep sounds at the other side for 10 seconds.
- In case of reception, a beep sounds at the other side for 14 seconds.

2

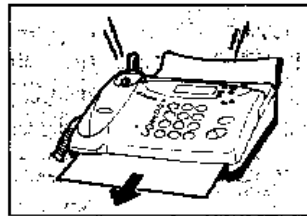

When the other party pick up the handset, you hear the short beep.

- If you lift the handset and replace it, phone reservation is canceled.
- If the other party does not pick up the handset while the beep sounds, the phone line will be disconnected.
- If the other unit does not have phone reservation function, the phone line will be disconnected.

Phone reservation reception

If the other party initiates phone reservation, a beep sounds and the display shows PHONE CALLING. Lift the handset and talk to the calling party.

PAPER SAVE

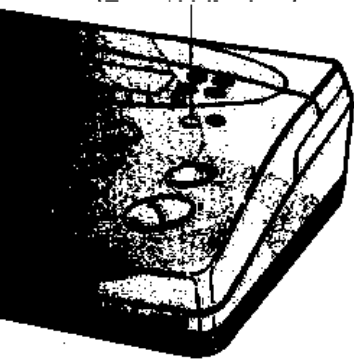

Copying modes (Enlargement/Reduction/Reform)

The copying feature of the SFX-20 offers four modes: **normal** (100%), **enlargement** (125%), **reduction** (80%) and **reform** mode.

The reform mode is used to stretch compressed images received by the paper-save mode back to the original appearance. The paper-save reception feature can be set using the menu. See paper-save reception on page 40.

1



Place the original document face down.

STANDARD
NORMAL
STAND-BY

2

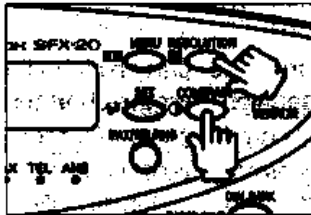

Select a contrast/resolution mode if necessary. (See page 26.)

- For copying, the SFX-20 uses FINE or SUPERFINE resolution only. (If the RESOLUTION key is set to STANDARD, FINE setting is automatically used.)

FINE
NORMAL
STAND-BY

3

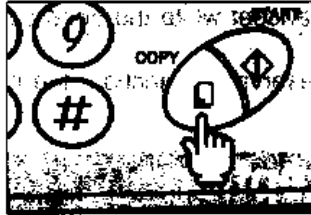

Press **COPY** to select the desired mode.

- The display changes each time the key is pressed: 100%-125%-80%-REFORM.

(REFORM is displayed when **PAPER SAVE** key lights.)

FINE
NORMAL
ZOOM RATE ? 100%

4

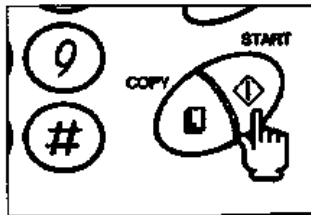

Press **START**.
➔ Copying begins.

FINE
NORMAL
*** COPY ***

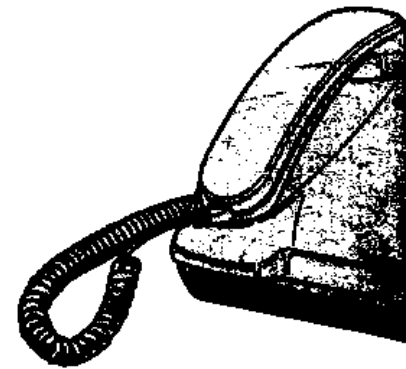

■ The feature switch No. 50 turns the zoom copy function (enlargement, reduction and reform) on and off. The initial setting is ON (01). (See page 57.)

Issuing memo sheet and fax message sheet

You can issue a memo sheet and a fax message sheet.

Operate the following procedure with no original document inserted in the original slot.

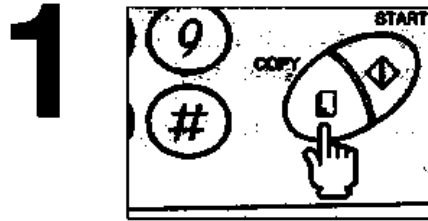

Press **[COPY]** to select the desired sheet.

- The display changes each time the key is pressed: MEMO SHEET-FAX SHEET.

STANDARD
NORMAL
MEMO SHEET ?

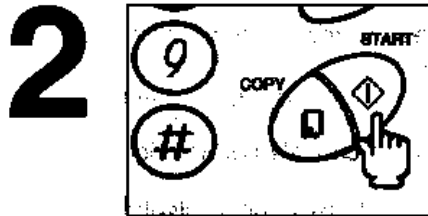

Press **[START]**.

- ➔ The selected sheet is issued.

STANDARD
NORMAL
** MEMO SHEET **

■ The memo sheet and fax message sheet can also be issued during telephone use.

Sample of memo sheet

<MEMO>

Sample of fax message sheet

*** FAX MESSAGE SHEET ***	
ATTN.	From
	Date
	FAX
Re:	

■ The programmed your station name and fax number appears automatically at the place of "From".

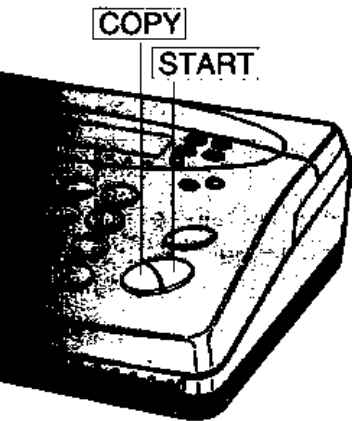

Diagnostic reports

The codes shown below appear on the activity report and transmission reports to help you diagnose any problems quickly and accurately.

ERROR CODE	DESCRIPTION
OK:	●Transmission/reception satisfactory.
10:	●No response from other party. Contact other party to make sure other machine is ready to receive.
12:	●No response to timer transmission.
20:	●[STOP/C] key pressed during transmission/reception.
21:	●Original jammed. Remove and replace correctly.
23:	●Recording paper ran out during reception. Replace recording paper.
27:	●Timer transmission canceled or no original inserted for timer transmission.
30:	●Printing quality poor due to poor telephone line connection. If this code appears frequently, contact an authorized Sanyo service center.
40:	●Other party's fax machine in abnormal condition (no recording paper, etc.). Contact the other party.
50:	●Transmission was halted by the other party. (Line was disconnected during transmission/reception.)
60:	●Communication impossible due to phone line.
71:	●Communication impossible due to compatibility problems. Contact other party.

Menu selection

Press **MENU** and number keys (1-5) to select the function that you want to program or change.

Press **1**.

To set polling reception	STANDARD
	NORMAL
	1 : POLLING Rx . ?

Press **2**.

To set activity report	STANDARD
	NORMAL
	2 : ACT. REPORT ?

Press **3**.

To program one-touch/speed dial	STANDARD
	NORMAL
	3 : O.T & S.D SET ?

Press **4**.

To set timer transmission.	STANDARD
	NORMAL
	4 : TIMER Tx . ?

Press **5**.

To set set mode for details see page 56.	STANDARD
	NORMAL
	5 : SET MODE ?

Polling reception

The polling reception feature allows the SFX-20 to call another party and instruct the other party's machine to transmit a document to your number. (The other party's fax machine must be set to polling transmission mode.) The cost of the call is billed to the receiving party.

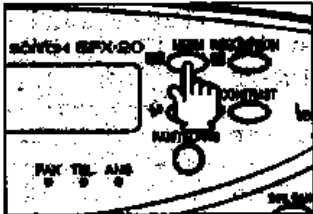
1  Press **MENU**.

STANDARD
NORMAL
1: POLLING Rx. ?

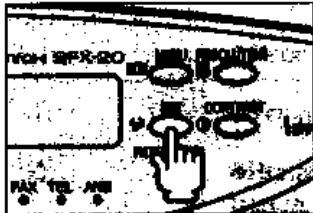
2  Press **SET**.

STANDARD
NORMAL
PARTY ?

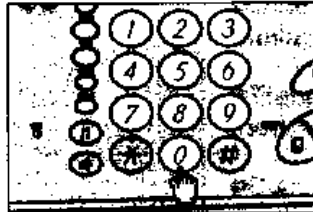
3  Dial the other party's fax number.
 • Use the Number keys or One-touch/Speed dial/DIAL BANK.

STANDARD
NORMAL
1 2 3 4 5 6 7 8

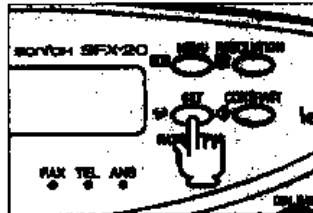
4  Press **SET**.
 → Dialing begins.

STANDARD
NORMAL
1 2 3 4 5 6 7 8 9

5  When the line is connected, reception begins automatically.

■ If you make a mistake when entering a phone number, press **STOP/C**, then enter the correct number.

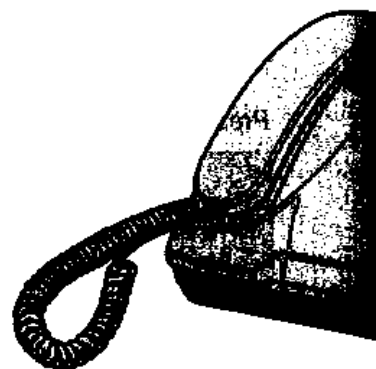

Activity report

The SFX-20 prints out an activity report automatically reached 20 of the transmissions and/or receptions. The results issued automatically are cleared from memory.

The initial factory-setting is OFF (non-issue). You can change the setting to ON (issue), follow the procedure below.

To set activity report

1

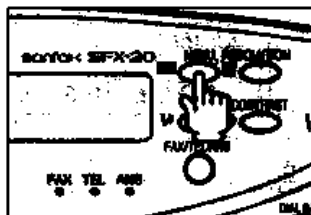

Press **MENU**.

STANDARD
NORMAL
1: POLLING Rx. ?

2

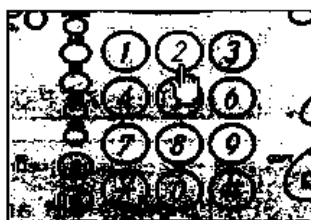

Press **2**.

STANDARD
NORMAL
2: ACT. REPORT ?

3

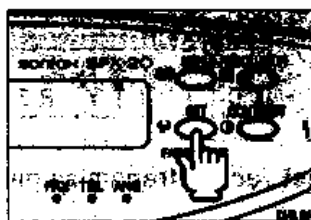

Press **SET**.

STANDARD
NORMAL
AUTO PRINT: OFF

4

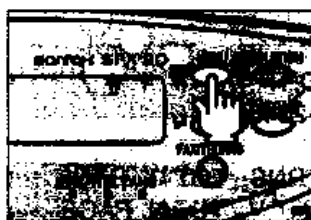

Press **MENU** to select ON or OFF.
 • Each time the key is pressed, the display shows ON-OFF.

STANDARD
NORMAL
AUTO PRINT: ON

5

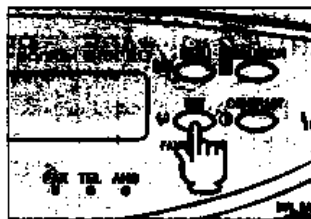

Press **SET**.
 → A beep sounds.

STANDARD
NORMAL
10 Jun. '94 12:00

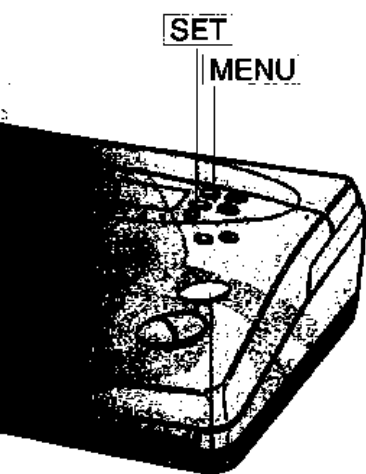

STOP/C

To issue an activity report manually

You can print out an activity report at any time and confirm the result of transmissions and/or receptions.

1

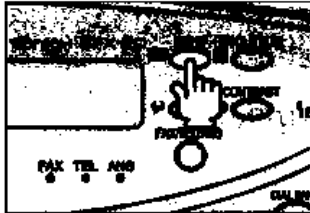

Press **MENU**.

```
STANDARD
NORMAL
1 : POLLING R x . ?
```

2

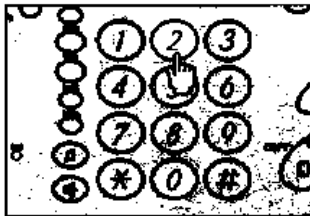

Press **2**.

```
STANDARD
NORMAL
2 : ACT. REPORT ?
```

3

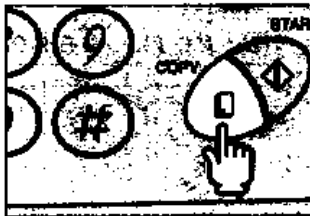

Press **COPY**.

→ The SFX-20 prints out an activity report.

```
STANDARD
NORMAL
ACTIVITY REPORT
```

■ The report shows up to 20 of the most recent transmissions and/or receptions.

Sample of activity report

*** ACTIVITY REPORT ***						
10 Jun '94 15:00 SFX20 123456						
					TRNS. TOTAL PAGE	000002
					RECV. TOTAL PAGE	000003
TRNS.						
No.	DATE	START	TIME	PARTNER	PAGE	RESULT ERROR CODE
1	10 Jun.	12:15	0'25	DEALER A	1	OK
1	10 Jun.	13:14	0'35	DEALER B	1	OK
RECV.						
No.	DATE	START	TIME	PARTNER	PAGE	RESULT ERROR CODE
1	10 Jun.	12:35	0'32	DEALER A	1	OK
1	10 Jun.	14:05	0'52	DEALER B	2	OK

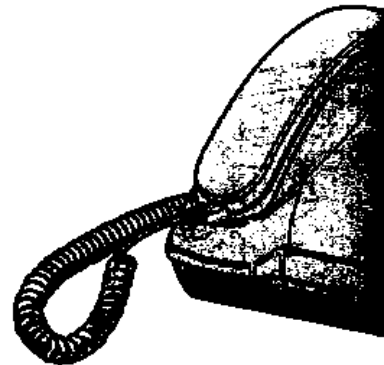

One-touch dial/Speed dial memory programming

Up to 24 telephones or fax numbers (and corresponding names) can be stored in the SFX-20's digital memory. Each of the 4 one-touch dialing keys (A-D) can be used to store a fax number or a telephone number. An additional 20 numbers (fax or telephone) can be stored using the speed dialing numbers (01-20).

1

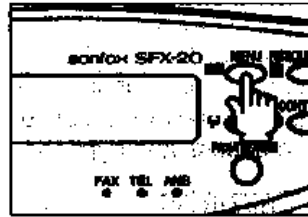
Press **MENU**.

STANDARD
NORMAL
1 : POLLING Rx . ?

2

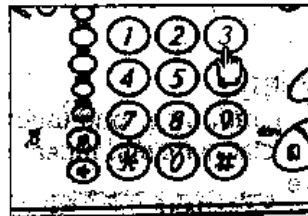
Press **3**.

STANDARD
NORMAL
3 : O.T & S.D SET ?

3

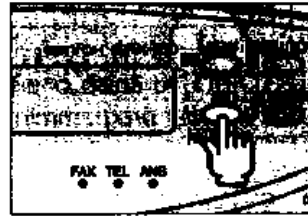
Press **SET**.

STANDARD
NORMAL
O.T No. = [] ?

4

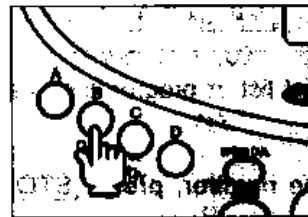

Press one-touch dialing key (A-D) or 2 digits speed dial number(01-20).

STANDARD
NORMAL
O.T No. = [] ?

5

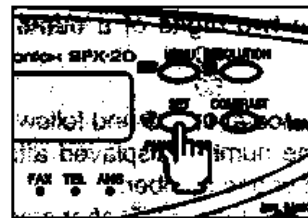
Press **SET**.

STANDARD
NORMAL
PARTY'S NAME ?

6

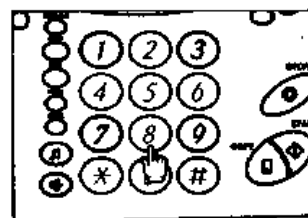

Enter the party's name (to a maximum of 16 characters).

See page 14 for detailed instructions.

STANDARD
NORMAL
DEALER A [] : ABCDE

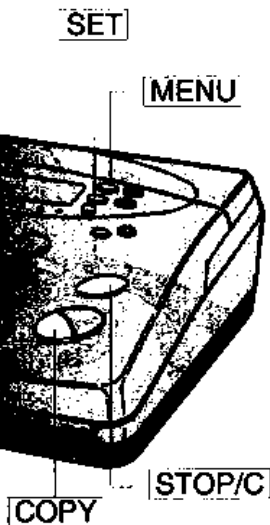

7

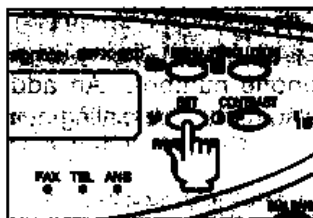
Press **SET**.

STANDARD
NORMAL

8

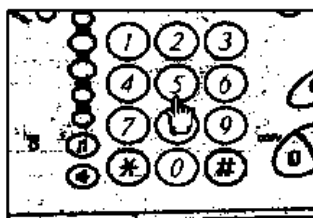

Enter the fax (or telephone) number. (A maximum of 32 digits can be entered including pauses and hyphens.)

STANDARD
NORMAL
1 2 3 4 5 6 7 8

9

Press **SET**.

- To program other one-touch keys or speed dial numbers, repeat steps 4-9 above.

STANDARD
NORMAL
O. T No. = ?

10

Press **STOP/C** to finish one-touch and speed dial number programming.

STANDARD
NORMAL
10 Jun. '94 12:00

- For instructions on printing out a numerical list of programmed names and numbers, see page 51.
- To interrupt programming, press **STOP/C**.
- If you make a mistake in entering phone number, press **STOP/C** and re-enter the correct number.
- To enter a hyphen (-), press **SPEED DIAL**.
- To enter a three-second pause between two digits of a number, press **PAUSE** in the appropriate place.
A semicolon (;) indicates a pause.
- To change the programming, press **SET** twice at step 5 and follow the steps 6-10. In this case, the programmed phone number displayed after step 7, press **STOP/C** and enter the your desired phone number.
- To cancel the programming, press **MENU** and then **SET** after step 5.

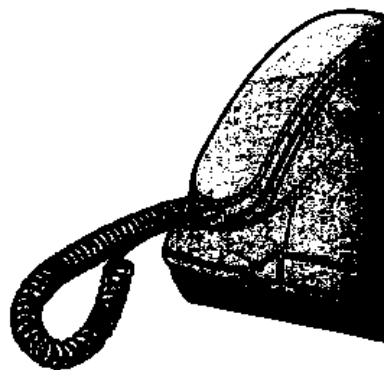
**PAUSE**

Printing a number list

You can print a list of the programmed one-touch dialing and speed-dialing numbers.

1

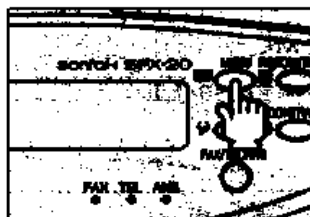

Press **MENU**.

STANDARD
NORMAL
1 : POLLING R x . ?

2

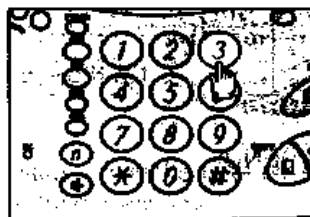

Press **3**.

STANDARD
NORMAL
3 : O . T & S . D SET ?

3

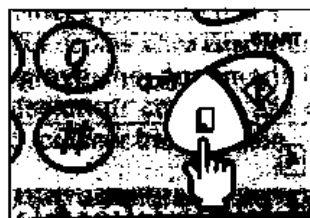

Press **COPY**.

- ➔ The SFX-20 issues a number list.
- To return to stand-by mode, press **STOP/C**.

STANDARD
NORMAL
** O . T & S . D LIST **

Sample of a number list

* * * ONETOUCH,SPEED DIAL LIST * * *			
10 Jun '94 17:03 SFX20 123456			
	No.	PARTY'S NAME	NUMBER
ONETOUCH DIAL	A	DEALER A	123456789
	B	DEALER B	112233
SPEED DIAL	01	DEALER C	556677
	02	DEALER D	778899

SPEED DIAL

SET

MENU

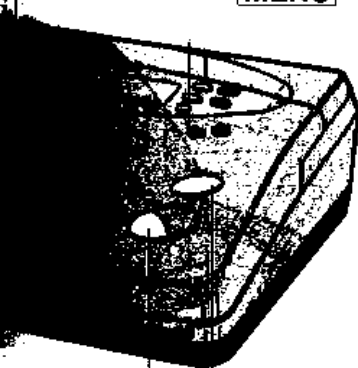

STOP/C

COPY

Timer transmission

The SFX-20 can be programmed for delayed fax transmission. The delayed start time can be set up to 24 hours in advance. A document of up to 5 pages can be programmed for timer transmission to one destination.

1 Place the original document face down.



2 Select a contrast/resolution mode if necessary. (See page 26.)



3 Press **MENU**.

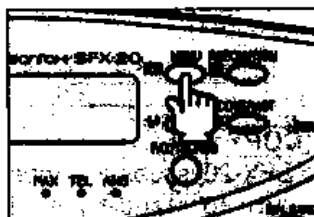

4 Press **4**.

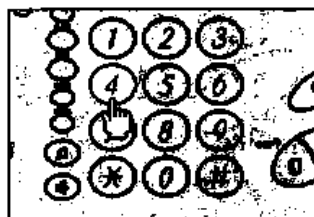

5 Press **SET**.

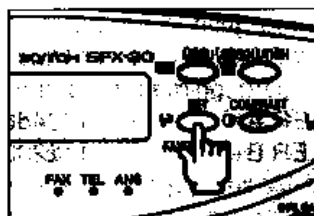

6 Enter a delayed start time using the number keys. (The start time must be entered using the 24-hour system.)

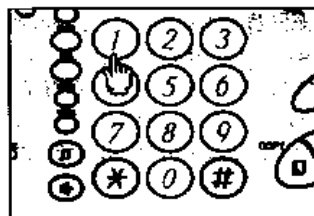

7 Press **SET**.

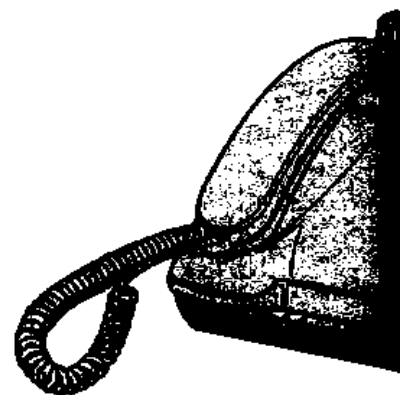
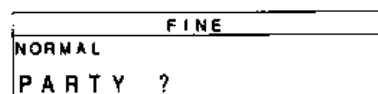
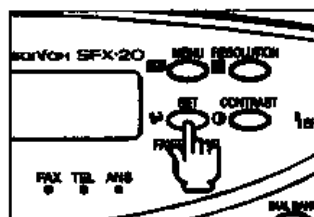

8

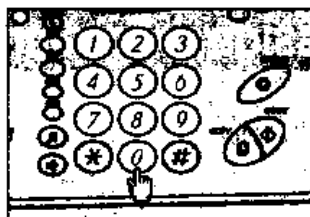

Enter the fax number.

- Use the number keys, one-touch and speed dial numbers.

FINE
NORMAL
DEALER A

9

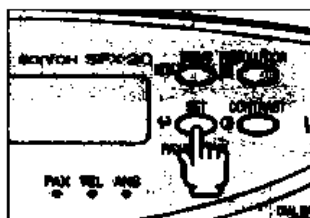
Press **SET**.

FINE
NORMAL
< TIMER Tx . 17 : 00 >

- If you make a mistake in entering a start delayed time, press **STOP/C** and re-enter the correct time.
- Incoming fax messages can still be received (auto and manual reception) after a timer transmission is set. It is also possible to transmit fax messages and make copies after timer transmission is set. To do this, press **STOP/C** and remove the document inserted for timer transmission. When transmission or copying are completed, simply replace the document inserted for timer transmission.

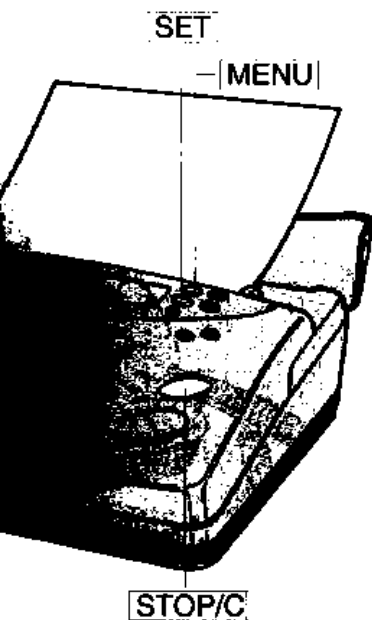

Timer transmission report

When a timer transmission is completed, a timer transmission report is printed out automatically.

Sample of a timer transmission report

* * * TIMER TRNS. REPORT * * *				
10 Jun '94 17:01 SFX20 123456				
No.	START	PARTNER	SET TIME 17:00 PAGE	RESULT ERROR CODE
1	17:00	2	1	OK

- Timer transmission report feature can be disabled using feature switch No. 32. (See page 57.) The switch is initially factory-set to the ON (issue) position.
- If a fax number is busy when a timer transmission is attempted, the number is automatically redialed three times. The number of redials can be changed using the feature switch No. 05. (See page 57.)

functions

To change timer transmission programming

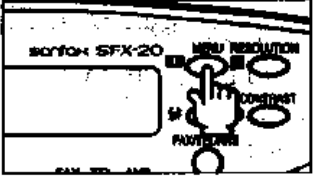
1  Press **MENU**.

	FINE
NORMAL	
1 : POLLING R x . ?	

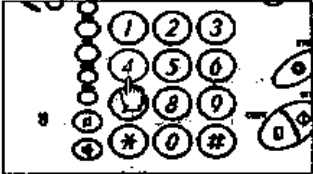
2  Press **4**.

	FINE
NORMAL	
4 : TIMER T x . ?	

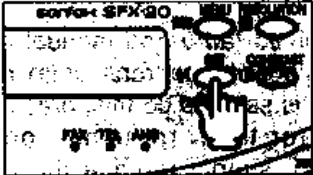
3  Press **SET**.

	FINE
NORMAL	
TIMER T x . : CHANGE	

4  Press **SET** again.

	FINE
NORMAL	
START TIME 17 : 0	

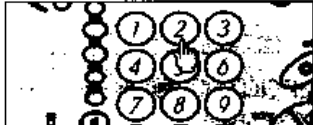
5  Enter a delayed start time, if required to change.

- If not required to change the time, proceed to step 6.

	FINE
NORMAL	
START TIME 17 : 3	

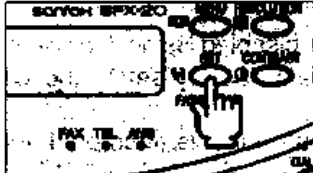
6  Press **SET**.

	FINE
NORMAL	
DEALER A	

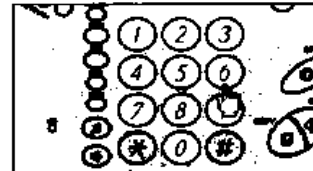
7  Press **STOP/C** to clear the programmed phone number and enter the new phone number.

- If not required to change the phone number, proceed step 8.

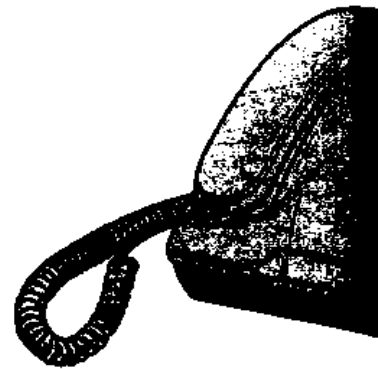

8

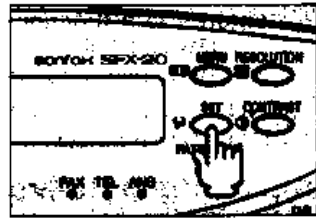

Press **SET**.

FINE
NORMAL
< TIMER Tx . 17 : 30 >

To cancel timer transmission

1

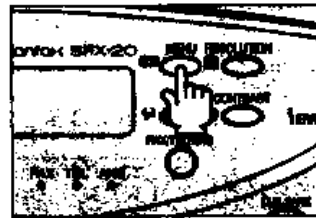

Press **MENU**.

FINE
NORMAL
1 : POLLING Rx . ?

2

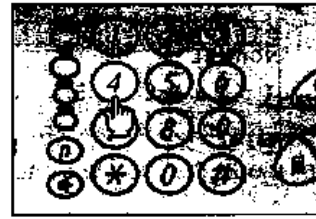

Press **4**.

FINE
NORMAL
4 : TIMER Tx . ?

3

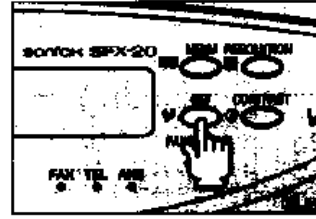

Press **SET**.

FINE
NORMAL
TIMER Tx . : CHANGE

4



Press **MENU**.

FINE
NORMAL
TIMER Tx . : CANCEL

5



Press **SET**.

➔ A beep sounds.
 Timer transmission is canceled.
 The SFX-20 issues a timer transmission report.

FINE
NORMAL
** CANCELLED **

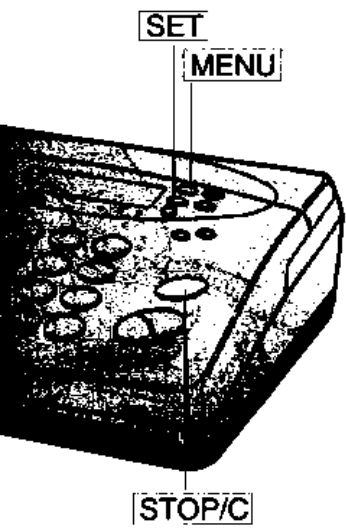

Programming functions

Set mode selection

Various programming modes for the SFX-20 features and functions can be selected using **MENU** and number keys.

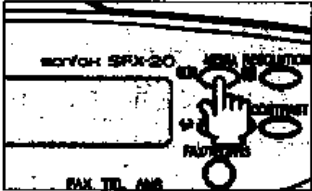
1  Press **MENU**.

STANDARD
NORMAL
1 : POLLING Rx. ?

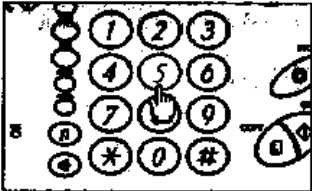
2  Press **5**.

STANDARD
NORMAL
5 : SET MODE ?

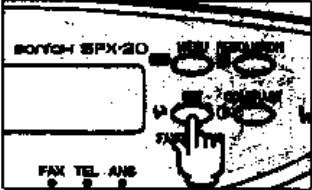
3  Press **SET**.

STANDARD
NORMAL
1 : TIME SET ?

4 Press number keys to select the set mode that you want to program or change.

Press **1**.

Calendar/clock setting mode (see page 16.)
STANDARD
NORMAL
1 : TIME SET ?

Press **2**.

Header print programming mode
STANDARD
NORMAL
2 : STATION CODE ?

Press **3**.

Feature switch setting mode
STANDARD
NORMAL
3 : FEATURE SW. ?

Press **4**.

Black list setting mode
STANDARD
NORMAL
4 : BLACK LIST ?

Press **5**.

Dial bank setting mode
STANDARD
NORMAL
5 : DIAL BANK ?

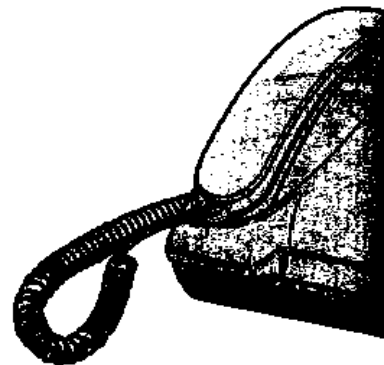

Feature switches

The SFX-20 various feature switches were factory-preset to standard (default) settings before the unit was shipped to you.

To provide you with more choices the SFX-20 allows you to change these feature switch settings.

The feature switches and their functions are listed on page 59-61.

To change feature switch settings

1

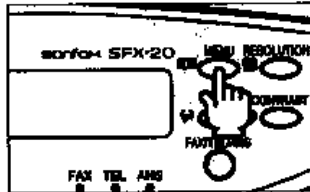
Press **MENU**.

STANDARD
NORMAL
1 : POLLING Rx . ?

2

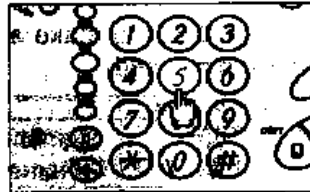
Press **5**.

STANDARD
NORMAL
5 : SET MODE ?

3

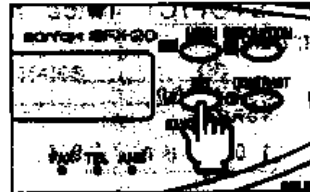
Press **SET**.

STANDARD
NORMAL
1 : TIME SET ?

4

Press **3**.

STANDARD
NORMAL
3 : FEATURE SW . ?

5

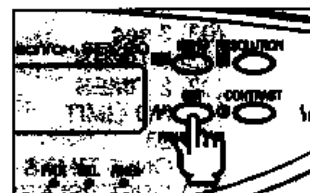
Press **SET**.

STANDARD
NORMAL
(0) PAUSE TIME

6

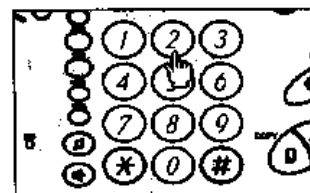

Enter the number of the switch you want to change.

Example: To change the hold button melody, press **1** and **0** to select feature switch No. 10.

STANDARD
NORMAL
(1) MELODY

SET
MENU

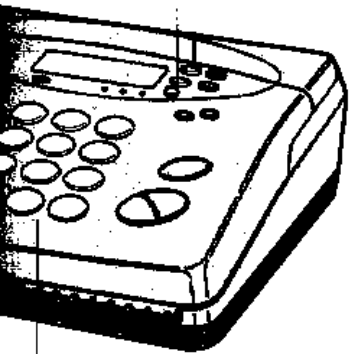

Number keys

7

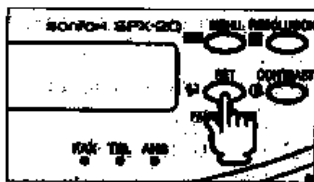
Press **SET**.

STANDARD
NORMAL
GREENSLEEVES (0)

8

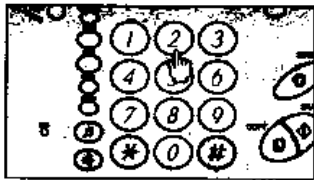

Enter the code of your choice.

Example: To change the hold button melody to Minuet, enter **0** and **1**.

STANDARD
NORMAL
MINUET (0)

9

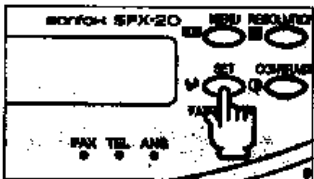
Press **SET**.

● Repeat steps 6-9 to make additional changes (as required).

STANDARD
NORMAL
(1) VOICE

10

Press **STOP/C** twice to finish programming.

STANDARD
NORMAL
10 Jun. '94 12:00

■ To interrupt the feature switch setting procedure, press **STOP/C**.

■ To print out a feature switch setting list, press **COPY** after step 4.

Sample of feature switch list

* * * FEATURE SW. LIST * * *		
23 Jun. '94 12:00		
No.	SWITCH NAME	INITIAL SET
[01]	PAUSE TIME	(03) 3 sec
[05]	TIMER REDIAL	(03) 3 TIMES
[06]	AUTO REDIAL	(02) 2 TIMES
[07]	No. OF RINGS	(00) NO LIMIT
[08]	REMOTE Rx.	(33) 33
[09]	F/T SW. OVER	(02) ON: 5 TIMES
[10]	MELODY	(02) GREENSLEEVES
[16]	VOICE	(01) ON
[17]	KEY SOUND	(02) HIGH
[19]	REDUCTION	(01) ON
[20]	HEADER PRINT	(01) ON: OUTSIDE
[26]	CLOSED (Rx.)	(00) OFF
[27]	RESOLUTION	(03) NOT RETURN
[28]	CONTRAST	(03) NOT RETURN
[31]	Tx. REPORT	(00) OFF
[32]	TIMER REPORT	(01) ON
[36]	HALFTONE	(01) PATTERN2
[50]	ZOOM COPY	(01) ON
[54]	AUTO PROG.	(01) ON
[55]	PAPER SAVE	(00) 50% SAVE
[56]	DUPLEX RING.	(00) OFF

Feature switch list

Switch No.	Setting items	Setting No.	Description	Factory setting
01	Pause time.	02	02 sec.	03
		03	03 sec.	
		04	04 sec.	
		05	05 sec.	
		06	06 sec.	
		07	07 sec.	
		08	08 sec.	
		09	09 sec.	
		10	10 sec.	
		11	11 sec.	
		12	12 sec.	
		05	Number of redial attempts after timer transmission attempt. (3-4 minutes intervals)	
01	1 time			
02	2 times			
03	3 times			
06	Number of automatic redial attempts after regular transmission attempt using manual, one-touch or speed dialing. (2-3 minutes intervals)	00	OFF (No redial)	02
		01	1 time	
		02	2 times	
		03	3 times	
07	Number of rings the SFX-20 issues before connecting to the line.	00	No limit	00
		01	7 rings	
		02	9 rings	
		03	11 rings	
		04	13 rings	
		05	15 rings	
08	Remote receiving capability	00	OFF (No remote reception possible)	33
		10	ON	
		1	(2-digit remote reception activation number.)	
		99		
09	Number of rings that the SFX-20 issues after connecting to the line during the FAX reception mode, but before switching to fax reception mode for an incoming manual fax or voice call.	00	OFF (No rings/No auto switching)	02
		01	3 rings (Auto switching)	
		02	5 rings (Auto switching)	
		03	7 rings (Auto switching)	
		04	9 rings (Auto switching)	
		05	11 rings (Auto switching)	
10	Music on hold (See page 18.)	00	Silence (No music)	02
		01	Minuet	
		02	Greensleeves	

Switch No.	Setting items	Setting No.	Description	Factory setting
16	Voice response	00 01	OFF ON	01
17	Key operation beeps	00 01 02	OFF (No beep) ON (Low) ON (High)	02
19	Auto reduction	00 01	OFF ON	01
20	Header print Determines whether your station name, fax number and date/time are printed on the header	00 01 02	OFF ON (Printing outside of original) ON (Printing inside of original)	01
26	Closed network communication (Receiving). Determines whether reception is restricted to programmed fax number. (See page 62.)	00 01 02	OFF ON (White list) ON (Black list)	00
27	Home position of the resolution mode. (See page 26.)	00 01 02 03	STANDARD FINE SUPERFINE Not return	03
28	Home position of the contrast mode. (See page 26.)	00 01 02 03	NORMAL LIGHT HALFTONE Not return	03
31	Transmission report (See page 28.)	00 01 02	OFF ON (after each transmission) ON (when an error occurs)	00
32	Timer transmission report (See page 53.)	00 01	OFF (No report issued) ON (Report issued after timer transmission.)	01
36	Halftone quality (relative to transmission speed)	00 01	Faster transmission Better halftone quality at slower speed	01

Switch No.	Setting Items	Setting No.	Description	Factory setting
50	Enlargement/Reduction/Reform copy (See page 42.)	00	OFF (No enlargement/reduction/reform possible)	01
		01	ON (Enlargement/reduction/reform possible)	
54	Auto progress transmission and reception	00	OFF (need to press START key for manual transmission and reception.)	01
		01	ON (no need to press START key for manual transmission and reception.)	
55	The compression percentage of paper save (See page 40.)	00	50%	00
		01	75%	
56	Duplex ringing After turn on duplex ringing feature, the switch No. 07 and 09 will be NO FUNCTION and the machine automatically receive incoming FAX after two ringings. (See page 63.)	00	OFF	00
		01	ON	

Closed network communication (feature switch No. 26)

This feature allows you restrict reception to certain parties. When this feature is selected, the unit checks the other party's fax/phone number (last 4 digits) and decides whether to receive.

Closed network communication can be turned ON (white list), ON (black list) or OFF using feature switch No. 26. (See page 57.) The initial factory setting is OFF.

Closed network communication has 2 ways.

White list

■ Reception is possible only when the other party's number is stored in the one-touch (4 parties) and speed dialing (20 parties) memory of your SFX-20. (Be sure to enter the other party's telephone number correctly.)

Notes:

- Unregistered numbers cannot be received.
- Even a registered number cannot be received if the other fax machine does not have a station identification feature or the station number has not been programmed in their fax machine. Check with your parties before setting this function.

Black list

■ The unit can not receive from the programmed parties as black list (Max. 5 parties).
To set the black list, see page 64.

Note:

- Also, if the other fax machine does not have a station identification feature or the station number has not been programmed in their fax machine, no receiving is carried out.

Duplex ringing (feature switch No. 56)

Duplex ringing can be turned ON or OFF using feature switch No. 56.
The initial factory setting is OFF.

Once duplex ringing has been set to the ON position, the feature switch No. 07 and 09 are not effective regardless of their setting position.

In case of FAX ring: SFX-20 detects FAX ring and FAX tone is released.

In case of normal ring: SFX-20 does not detect the ring and the ring sounds continuously until the operator picks up the handset or press .

When duplex ringing is set to ON position, **FAX/TEL/ANS** key is no longer activated and the lamps corresponding to each reception mode are all turned off.

Note: It is required to apply Hongkong Telecom to use this function.

Unless otherwise, do not change feature switch No. 56. If you changed feature switch No. 56 to ON position, it may cause a malfunction of the unit.

Black list programming

This feature allows you to restrict non-reception to the 5 parties.
Closed network communication feature (feature switch No. 26) must be set to 02 (ON/Black list).

1

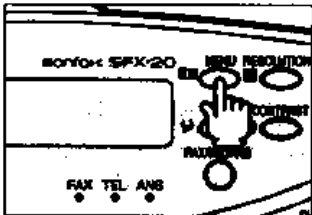

Press **MENU**.

STANDARD
NORMAL
1 : POLLING R x . ?

2

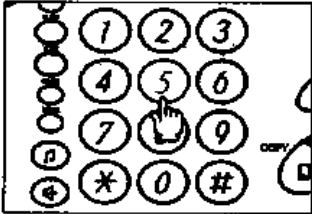

Press **5**.

STANDARD
NORMAL
5 : SET MODE ?

3



Press **SET**.

STANDARD
NORMAL
1 : TIME SET ?

4

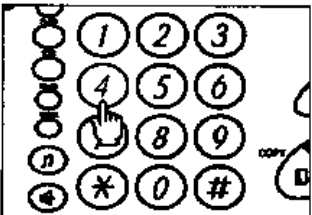

Press **4**.

STANDARD
NORMAL
4 : BLACK LIST ?

5

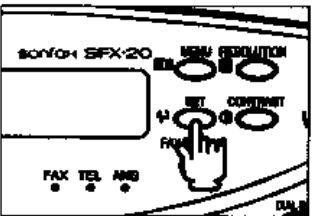

Press **SET**.

STANDARD
NORMAL
1 : ENTRY 2 : CNCL

6

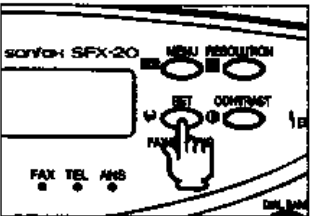

Press **SET** again.

STANDARD
NORMAL
(1) ■ : ENTRY

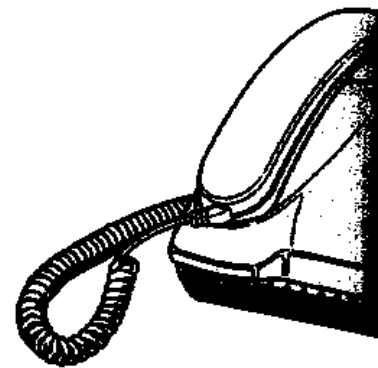

7

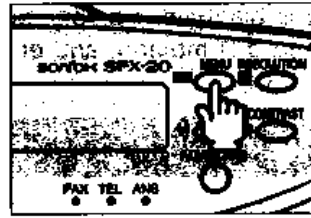

Press **MENU** to select the black list number(1-5).

●The display changes each time the key is pressed: (1)-(2)-(3)-(4)-(5).

STANDARD
NORMAL
(2) ■ : ENTRY

8

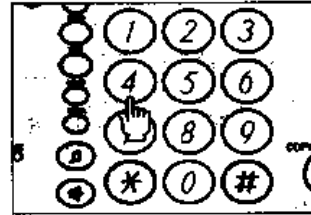

Enter the last 4 digits number of party's phone number.

STANDARD
NORMAL
(2) 1 2 3 ■ : ENTRY

9

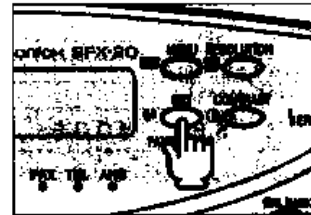

Press **SET**.

STANDARD
NORMAL
(2) 1 2 3 4 : ENTRY

10

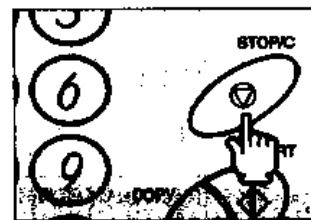

Press **STOP/C** twice to finish black list programming.

STANDARD
NORMAL
1 0 Jun. '94 12:00

SET
MENU

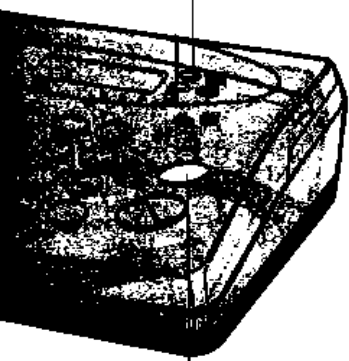

STOP/C

- If you make a mistake in entering 4 digits number, press **STOP/C** and then re-enter the correct number.
- To change the programming, press **STOP/C** after pressing **MENU** to select the number to be changed at step 7 and then re-enter the new 4 digits number. Follow the steps 9-10.
- To cancel the programming, press **2** instead of **SET** at step 6. Press **SET** after pressing **MENU** to select the number to be canceled at step 7.

Dial bank editing

You can edit the contents of the stored data in dial bank memory, adding the name, transferring to the one-touch and speed dial memory and erasing are available.

To add the party's name

1

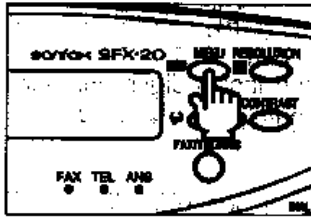
Press **MENU**.

STANDARD
NORMAL
1 : POLLING Rx . ?

2

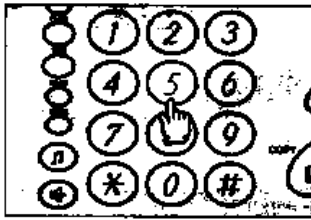
Press **5**.

STANDARD
NORMAL
5 : SET MODE ?

3

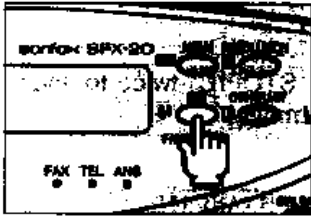
Press **SET**.

STANDARD
NORMAL
1 : TIME SET ?

4

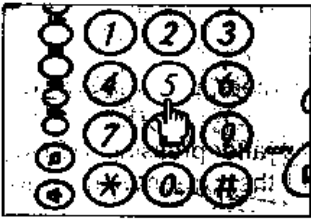
Press **5**.

STANDARD
NORMAL
5 : DIAL BANK ?

5

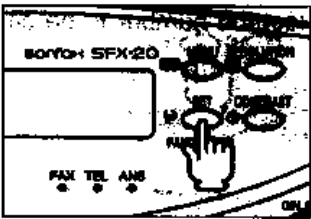
Press **SET**.

STANDARD
NORMAL
1 2 3 4 5 6 7 8 9

6

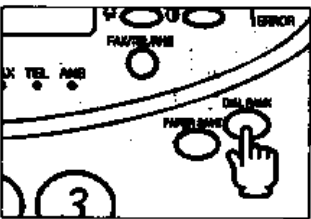
Press **DIAL BANK** to select the phone number to be program the name.

STANDARD
NORMAL
1 1 2 2 3 3

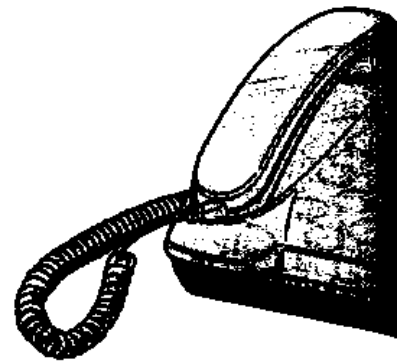

7

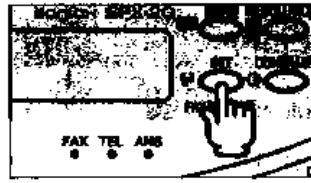
Press **SET**.

STANDARD
NORMAL
█ : A B C D E

8

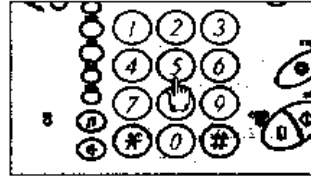

Enter the party's name. (See page 14 for detailed instructions.)

- To program this number and name to one-touch keys/speed dial numbers, proceed to step 7 of "to transfer to one-touch keys/speed dial numbers."

STANDARD
NORMAL
DEALER C █ : A B C D E

9

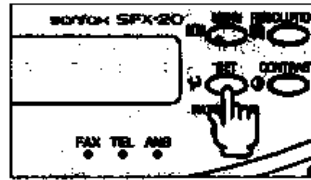
Press **SET**.

➔ The display shows the next phone number.

- Repeat steps 6-9 to program party's name to other phone numbers of dial bank.

STANDARD
NORMAL
5 5 6 6 7 7

10

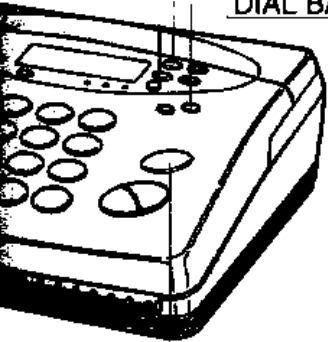
Press **STOP/C** twice to finish the dial bank editing.**SPEED DIAL****SET****MENU****DIAL BANK****STOP/C**

To transfer to one-touch keys/speed dial numbers

Operate steps 1-6 and follow the operation below.

7

Press **MENU**.

STANDARD
NORMAL
DATA ENTRY

8

Press one-touch dialing keys (A-D) or press **SPEED DIAL** and speed dial number using number keys.

STANDARD
NORMAL
S . D : 0 █

9

Press **SET**.

- Repeat steps 6-9 to program the number of dial bank to other one-touch keys or speed dial numbers.

STANDARD
NORMAL
ENTER D

10

Press **STOP/C** twice to finish the dial bank editing.

To erase

Operate steps 1-6 and follow the operation below.

7

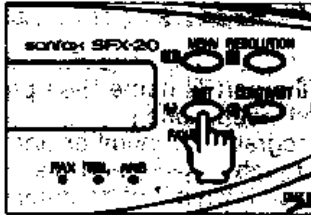

Press **SET**.

STANDARD
NORMAL
█ : A B C D E

8

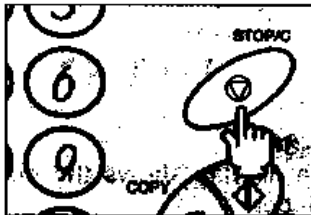

Press **STOP/C**.

STANDARD
NORMAL
CLEAR THE DATA ?

9



Press **SET**.

➡ The phone number is cleared.
The display shows the next phone number.

● Repeat steps 6-9 to clear the phone number of dial bank.

STANDARD
NORMAL
DATA CLEARED

10

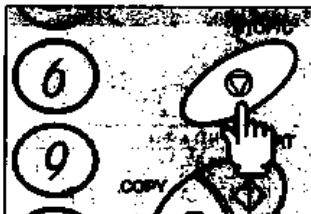

Press **STOP/C** twice to finish the dial bank editing.

STANDARD
NORMAL
10 Jun. '94 12:00

Thermal paper handling

The thermal paper is heat-sensitive. Follow the precautions below while handling it.

Storage precautions

The thermal paper will start to discolor gradually at about 70°C (158°F). It should not be exposed to heat, humidity or light, even when not in use.

To store it, take the following precautions.

1. Store in a dark, cool and dry place.
Avoid storing near heat-generating appliances or in enclosed places enclosed places subject to high temperatures (the trunk of a car, for example).
2. Once the package is opened, use the paper as soon as possible.

Handling precautions

1. If the thermal paper is touched with sweaty hands, fingerprints or smeared images may result.
2. If the thermal paper is rubbed against a hand, coloring may be caused by heat due to friction.
3. Coloring or erasure may occur if oil or other chemicals are allowed to come into contact with the paper.
Be careful in the following cases:
 - When gluing, use only water-soluble glue (commercially available).
 - When some adhesive tapes are used, coloring may result. The use of double-sided tapes on the back of the paper is recommended.
 - When storing the paper in plastic cases, use ones that are made of polyethylene, polypropylene or polyester. (Do not use PVC cases.)
 - Do not stack the paper along with polyvinyl chloride (PVC) films or heat-sensitive wax-type paper. The recorded images will fade, as these materials contain plastics.
 - Do not stack the paper with diazo- or wet-type photocopies immediately after they have been copied on. Ammonia, etc., may cause discoloring.
 - The paper will discolor if it comes into contact with alcohol or other volatile organic solutions.
4. Avoid exposing the paper to direct sunlight, as this tends to cause yellowing.

Jammed original

A beep sounds and display shows **ORIGINAL JAM**, if an original jams.
(If the **ERROR** lamp lights when the original jams, press **STOP/C** before operating below.)

1. Lift the operation panel forward.
 - ① Take off the handset.
 - ② Open the protective cover.
 - ③ Lift the operation panel forward.

3. Remove the jammed original while pressing the green release lever.

2. Raise the document release lever.

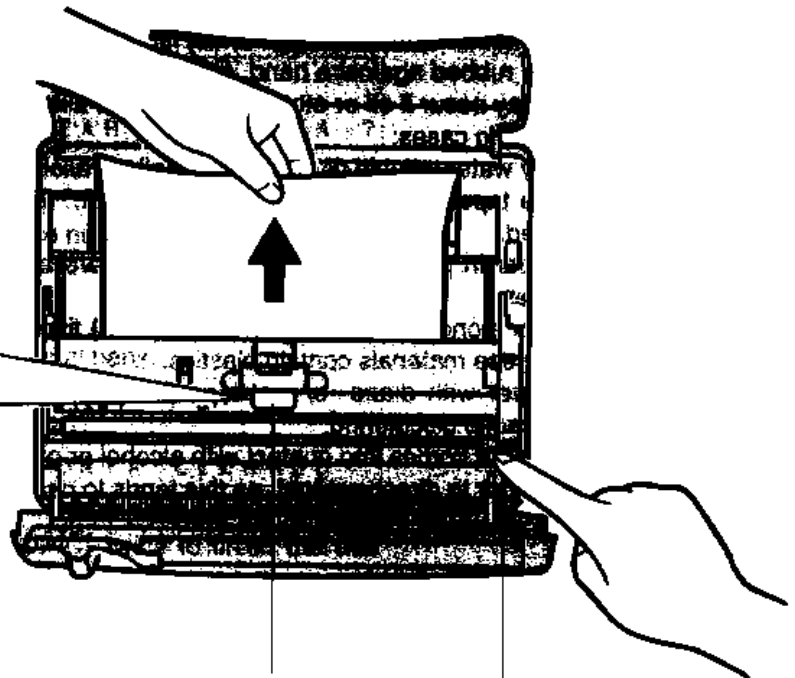
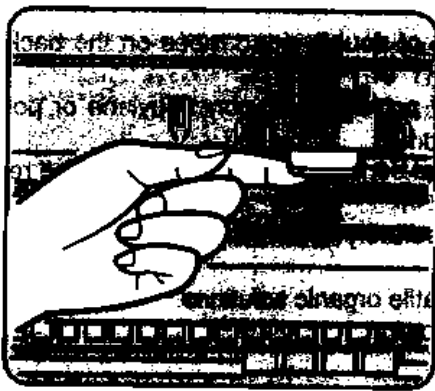

Document release lever

Green release lever

Jammed recording paper

A beep sounds and display shows **CHECK PAPER ROLL**, if the recording paper jams.

1. Open the recording paper cover.

- ① Take off the handset.
- ② Open the protective cover.
- ③ Lift the operation panel forward.
- ④ Press **OPEN** button.

2. Remove the jammed recording paper.

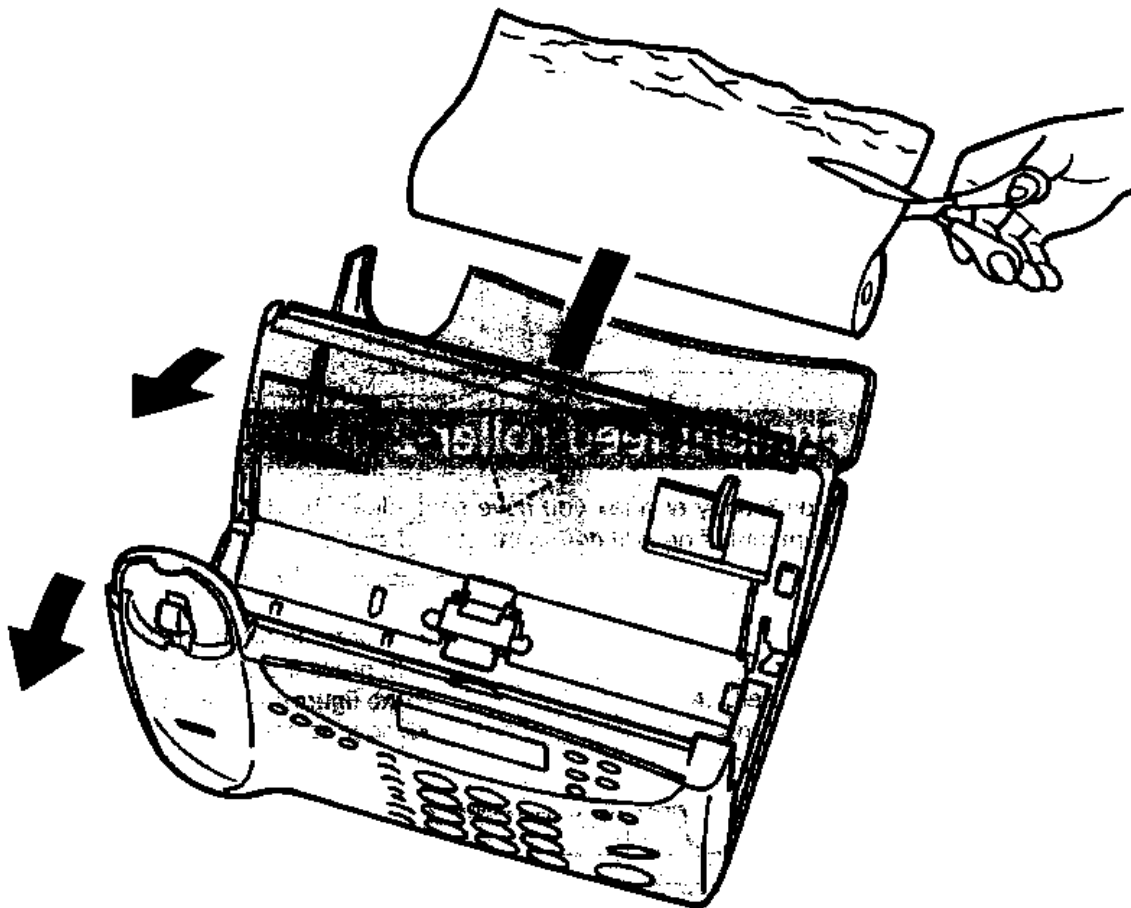

3. Cut off the jammed section of the recording paper and reinstall the roll.

Cleaning

Cleaning the housing (exterior plastic parts)

Gently wipe the housing with a soft, clean cloth dampened with a small amount of a neutral detergent.

●Do not use a cleaning agent such as alcohol or benzene.

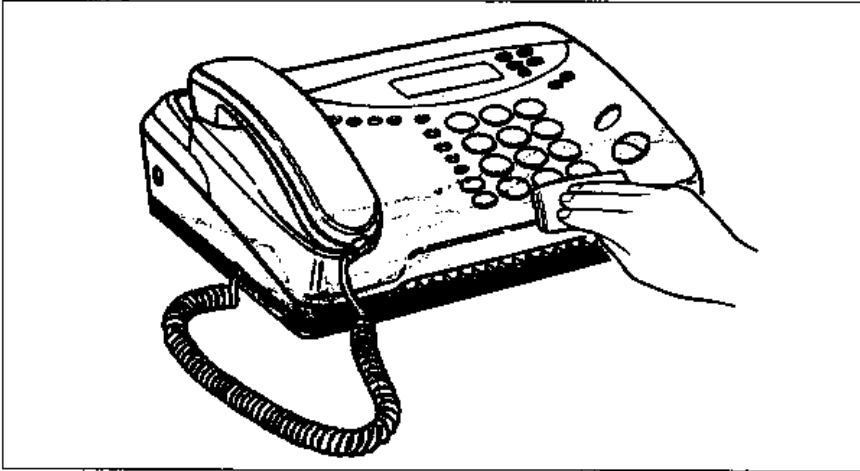

Cleaning the document feed roller-2

If a streak or dirty pattern appears on a copy or a fax you have sent, clean the document feed roller-2 with a soft, clean cloth dampened with a small amount of neutral detergent.

1. Lift the operation panel forward.

- ① Take off the handset.
- ② Open the protective cover.
- ③ Lift the operation panel forward.

2. In order to rotate the document feed roller-2, press the document sensor as shown in the figure.

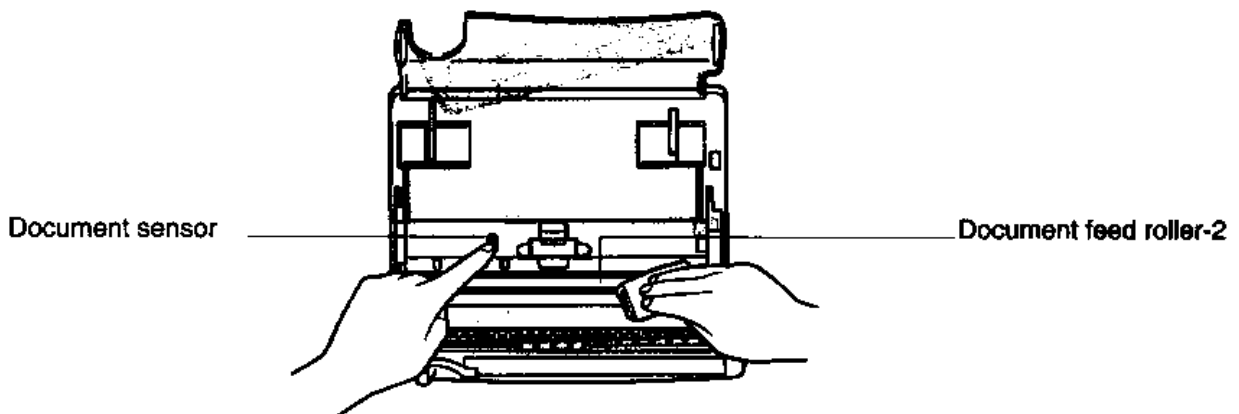

3. Clean the document feed roller-2, then dry it thoroughly to prevent the document from jamming.

Cleaning the document feed roller-1

If the document jamming or overlapping frequently occurs, clean the documentfeed roller-1 with a cotton swab dampened with a small amount of a neutral detergent.

1. Lift the operation panel forward.

- ① Take off the handset.
- ② Open the protective cover.
- ③ Lift the operation panel forward.

2. Pull the document release lever.

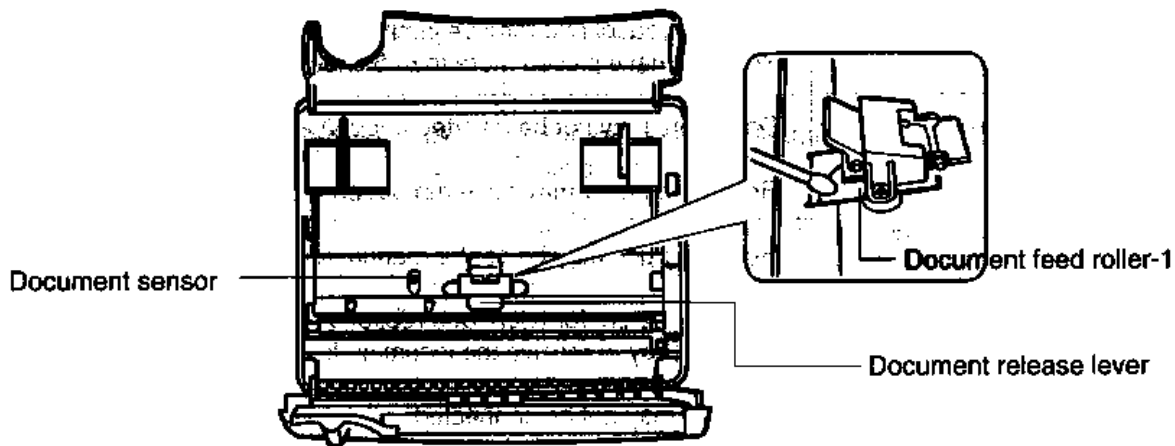

3. In order to rotate the document feed roller-1, press the document sensor as shown in the figure.

4. Clean the document feed roller-1, then dry them thoroughly to prevent the document from jamming.

Troubleshooting

If problems occur during operation, check below before taking the unit for service. If the problem cannot be corrected, contact dealer from whom the unit was purchased.

	Symptoms	Possible Causes/Solution	Page No.
General	Unit does not operate.	AC plug may not be connected to electrical outlet.	8
	The display indicates CHECK PAPER ROLL.	Recording paper may not be set properly.	10
		Recording paper may have run out.	
	Document cannot be inserted.	Document may be too thin too thick.	25
Another document may be jammed inside. Open operation panel and remove jammed document. You may have placed more than 5 sheets.		70	
Transmitting	Transmission is not possible.	Document may not be inserted enough into the slot.	27
		Recording paper may have run out on receiving unit.	-
		Receiving unit may be set for manual reception.	-
Reception	Reception is not possible. (Bell rings.)	Unit may be set for telephone reception mode. Press [START] key to receive the incoming fax transmission.	37
		AC cord may not be connected.	8
		Recording paper may have run out.	10
	Reception is not possible.	Closed network communication may be on. Check feature switch No. 26.	62
		Recording paper may have run out.	10
	Received copy is not dark enough.	The recommended recording paper is not used.	10
	Received copy is blank.	Transmitted original may be light.	26
		Recording paper may have been inserted upside-down.	10
	Transmitted original may have been upside-down.		
	Received copy contains illegible/distorted characters.	Phone connection may have been poor. (If problem continues, contact dealer.)	-
Red line appears on recording paper.	Recording paper has almost run out. Install a new recording roll.	10	
Error light	Error lamp lights.	Press [STOP/C] to turn off the error light. Print an activity report and check the error code.	48/44

	Symptoms	Possible Cause/Solution	Page
Phone call	No dial tone when handset is picked up.	Telephone line may not be connected properly.	8
	Sound from speaker is too low.	Monitor volume slide switch may be set to low.	4
	No ringer volume is heard.	Ringer volume switch may be set to "OFF".	4
	Fax/phone call does not connect to other party.	Wrong dialing mode may be set.	9
Extension phone	Impossible to place phone call.	Fax possibly being transmitted or received.	-
	Telephone does not ring.	Too many phones may have been connected to the same line.	-
	Remote reception does not work.	Remote reception feature switch No. 08 may have been set to off.	59
		If you have initiated the call from the extension phone, remote reception will not work.	-

Specifications

Type	Desk-top type transceiver
Line connected	Public switched telephone network
Size of recording paper	Thermal paper : 216mm(8.5") x 30m(98") High-grade thermal paper : 216mm(8.5") x 25m(82")
Effective scanning width	208mm (8.2") 252mm (9.9")
Effective recording width	212mm (8.3")
Transmission speed	9600/7200/4800/2400 BPS
Transmission time	Approx. 15 sec. (Transmission mode: Standard)
Main scanning density	8 pels
Sub scanning density	Standard mode : 3.85 lines/mm Fine mode : 7.7 lines/mm Super fine mode : 15.4 lines/mm
Compression mode	MH(Modified Huffman) and Sanyo original
Reading method	Flat-bed by Contact Image Sensor
Recording method	Flat-bed by Thermal printing head
Power supply	AC 220V, 50/60Hz
Power consumption	Stand-by: 10 W, Transmission: 25 W, Reception: 100 W, Copy: 110 W
Overall dimensions	299(W) x 126(H) x 231(D) mm 11.8"(W) x 5.0"(H) x 9.1"(D)
Weight	Approx. 3.3 kg (7.3 lb)
Ambient temperature	5°C - 35°C (41°F - 95°F)

Optional accessories:

Recording paper (30m/98")	R-4079448-1
High-grade thermal recording paper (25m/82")	3RE2182800450