

CONTAX T VS DIGITAL



Instruction manual

GB

Thank you for purchasing this Contax product.

The Contax Tvs DIGITAL is a digital camera equipped with a 3x optical zoom lens for high performance and high quality digital still photography.

Please read these instructions carefully before using the camera to ensure proper use and long service life.

The photographs used in these instructions are simulated images provided for the purpose of explanation.

Memory card

Use an SD memory card or a MultiMediaCard. These cards are referred to as "memory cards" in this instruction manual.

- * MultiMediaCard™ is a trademark of Infineon Technologies AG (Germany), and a technology licensed to MMCA (MultiMediaCard Association).

Check the Contents



Digital camera



Remote control



Memory card (SD card)



Battery pack (rechargeable in the camera)



Instruction manual



AC adapter (connect to camera when recharging the battery pack)



Quick Start Guide



USB cable (for connecting the camera to a PC)



Video cable (for connecting the camera to a TV)



CD-ROM (driver software)



Strap

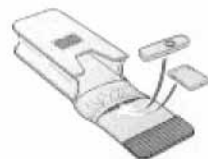

Camera case

Shooting images



Viewing images on the LCD monitor

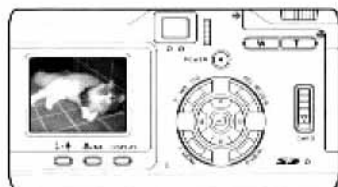

● Attach images to E-mail

- Save images to hard disk or CDR
- Use images as screen savers

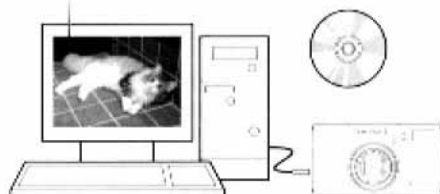

● Process images using retouch software

Connecting to a PC

You can connect your camera to a PC with a USB cable. Some operating systems may require you to install a USB driver. If this is the case, connect the camera to the PC after installing the USB driver. Note that the driver may not be correctly installed if the installation process is not performed correctly. For details, refer to page 96.

Viewing images on a TV screen

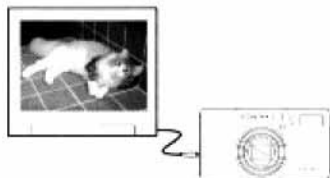

Printing digital images

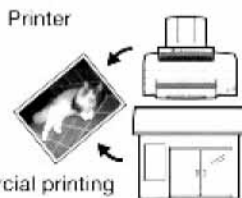

- * Like conventional film, digital prints can be processed by a commercial printing service. For details on services provided, contact your dealer.

Contents

Check the Contents	2
What this Camera Can Do	3
Handling Precautions	6
Names of Parts	10
LCD Monitor Indications	11
Viewfinder Display and Display Panel	12
LED Indicators	13

Preparations and Operating Checks

Preparations Before Shooting

1. Loading and Charging the Battery Pack	15
2. Installing and Removing the Memory Card	16
3. Setting the Time and Date	17
4. Imprinting the Date (Still Mode)	18
5. Adjusting the Diopter	18
6. Holding the Camera	18

Basic Operations

1. POWER Button	20
2. Shutter Release Button	20
3. Zoom Button	21
4. Mode Dial	21
5. "M/AF" Button	21
6. "M/MF" Button	22
7. REC REVIEW Button	22
8. ±WB ISO Button	22
9. "C MENU" Button	23
10. "D MENU" Button	24
11. AFL Button	25
12. DISPLAY Button	26
13. Optical Viewfinder	27

Photography

Simple Still Photography Procedure

1. "P" Program Auto Function	29
2. "Av" Aperture-Priority Auto	30
3. Confirming and Erasing Images	32
4. Flash Photography	34

Still Photography Techniques

1. Focus Lock Photography	39
2. Macro Photography	41
3. Manual Focus Photography	42
4. Exposure Compensation	43
5. White Balance Adjustment	44
6. ISO Setting	45
7. "C MENU" Photography	46
① Self-Timer/Remote Control Photography	46
② Spot Auto Focus Photography	48
③ Metering Mode Selection	49
④ Taking Pictures with the Exposure Auto Bracketing Control Mode (ABC mode)	50
⑤ Continuous Shooting	51
⑥ "LT" Longtime Exposure	52
⑦ Flash Exposure Compensation	53
8. "D MENU" Photography	54
① Changing Image COLOR	54
② PIXELS and QUALITY	54
③ Taking Pictures with the White Balance Shifted in Three Steps (WB/BKT Exposure)	56
④ Setting SHARPNESS	57
⑤ Adjusting CHROMA	57

Movie Recording

1. Recording Movies	59
2. Functions for Enhancing Movie Recording	60
① Focusing	60
② LCD Monitor Display	60
③ Exposure Compensation	60
④ Setting White Balance	61
⑤ Self-timer and Remote Control Recording	61
⑥ Setting Focus Area	62
⑦ With Sound/No Sound	62
⑧ Changing COLOR	63
⑨ Resizing	63

Playing and Erasing

Playing and Erasing Still Images

1. Displaying Images on the LCD Monitor 66
2. Close-up Image Playback (2x, 4x) 67
3. Displaying Exposure Information (Information Display) 68
4. Displaying Histogram (Brightness Distribution Graph) 68
5. Multiple Image Playback (Index Display) 69
6. [RECORDING] Adding Voice Memos to an Image 70
7. [PROTECT] Preventing Accidental Erasure 72
8. Erasing Images 73
9. [RESIZE] Resizing and Trimming 74
10. [ROTATE] Rotating Images 76
11. [AUTO PLAY] Playing Back Images Sequentially 77
12. [PRINT] Using DPOF to Prepare for Printing 78

Playing and Erasing Movies

1. Playing Movies 82
2. Protecting Movies 83
3. Erasing Movies 84

How to Use the Camera Setup Functions

1. Setup Function Lists 86
2. How to Change Setup Settings 87
3. Setup Menu Contents 88
 - <SET UP C.> 88
 - <SET UP D.> 89
4. "FORMAT" - Initializing the memory card 92
5. Setting a Start Screen 93

Connecting to Other Devices

1. Viewing Images on a TV 95
2. Connecting to a PC 96
 - <1. Computer Operating Environment> 96
 - <2. Connecting the USB Cable to the PC> 98
 - <3. Viewing Images on a PC> 99
 - <4. Removing Devices> 101
 - <5. When the Driver is no Longer Needed> 101
 - <6. Installing PIXELA ImageMixer Ver.1.0> 101

Other Information

1. Troubleshooting 103
 2. Modes and Function Settings 105
 3. Main Specifications 106
- Index 108

Attaching the Strap

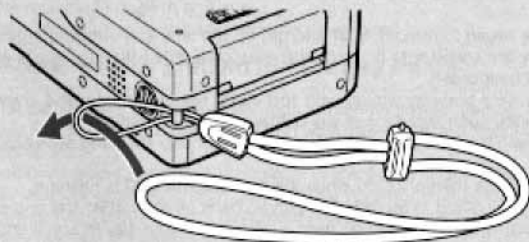

Preparations and Operating Checks

Photography

Playing and Erasing

Setup

Connecting to Other Devices

Other Information

Caution and Warning Symbols

This instruction manual features the following caution and warning symbols to indicate items of special importance. Be sure to read through the contents of these warnings, and use the features correctly.



DANGER

This symbol indicates an immediately hazardous situation which if not avoided, will result in death or serious injury.



WARNING

This symbol indicates a potentially hazardous situation which if not avoided, could result in death or serious injury.



CAUTION

This symbol indicates a potentially hazardous situation which, if not avoided, may result in minor injury or equipment damage.

Handling Precautions

<Camera Handling Precautions>



WARNING

- If the camera or battery pack becomes hot, emits smoke or a strange smell, or display other abnormal symptoms, remove them from the camera immediately to prevent fire. When handling the battery pack, take precautions to avoid being burned.
- Never attempt to disassemble or modify the camera, since you may receive a severe electric shock.
- Do not operate the electronic flash in close proximity to a person's eyes (especially those of an infant), since eye damage may result.
- Do not look at the sun or other strong light source through the camera, since your eyesight may be damaged.
- Do not attempt to take pictures while driving or walking, particularly when looking through the viewfinder or at the LCD monitor, since you may cause an accident.
- When taking pictures, remain aware of your surroundings and what is happening around you.



CAUTION

- Clean the camera well after using it on the beach or other locations where it may be exposed to sand or dust. Salt air may lead to corrosion of metal components and damage or short circuit electronic parts, causing the camera to emit smoke or catch fire. Sand inside the camera may result in internal damage and operating malfunctions.
- Sudden changes in temperature that occur when the camera is brought from a cold place to a warm room may cause the lens to fog up. This condition will clear after a while, but repeated exposure may cause condensation to form on the lens and internal parts. Such condensation may damage or short circuit electronic parts, causing the camera to emit smoke or catch fire. Whenever possible, avoid subjecting the camera to sudden changes in temperature.
- This camera is a precision electronic instrument, and should be protected from impacts and shocks that might damage or short-circuit internal components.
- **When taking the camera overseas or using it to record important events, check its operating condition and take test pictures beforehand to confirm proper operation.**

- This camera is not designed to be waterproof, and cannot be used in the rain or under water. If the camera should inadvertently be exposed to water, it should immediately be taken to a Contax Service Center for inspection.
- Use a blower brush to remove dust and dirt on the lens and viewfinder glass, or wipe gently with a soft lens brush. If they are soiled with fingerprints, wipe off lightly with lens tissue. Wipe off dust and dirt on the mirror lightly with a lens brush.
- Clean the camera body by wiping with soft cloth. Never use benzene, thinner, or other volatile solvents or cleansers, since such substances will damage the body materials.
- The camera will become warm when used for extended shooting sessions. This is normal and not a cause for concern.
- Do not remove the memory card while the card access LED is flashing.
- Interference may occur in recorded or played back images when the camera is used in areas subject to strong electromagnetic interference (e.g., near a television set or stereo speakers).
- Do not aim the camera lens directly at the sun when shooting, since the CCD element may be damaged.
- Dropping the camera may cause damage to internal parts even though the camera may appear to be undamaged. Always take the camera to a Contax Service Center for inspection if it has been dropped.
- Do not touch the inside of the memory card slot, since damage or malfunction may result.

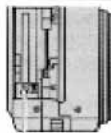

Reset button (R)

Microprocessor Protection Circuit:

This camera incorporates a safety circuit to protect its microprocessor against strong external static electricity. In rare instances, the camera may fail to function because this safety circuit has been triggered.

Should this happen, set the main switch to OFF, remove the battery pack, reload it and press the reset button (R) inside the memory card door. Then turn the camera on again.

- Note that this operation will reset the date and time settings to their factory defaults.

For best performance, we recommend the use of genuine Contax accessories.

Contax is not responsible for any accidents or damage caused by the use of accessories made by other manufacturers or fashioned by the user.

Copyright

Photographs taken of professional performances, exhibitions, displays, or copyrighted materials may be used only for your own personal enjoyment, and only with the consent of the copyright holders.

Other use may constitute violation of applicable copyright laws.

Be aware that some performances, exhibitions, or displays may impose restrictions on photographic or other recording even when the purpose of such recordings is personal enjoyment.

Test Photos and Warranties

Make it a practice to take test shots before taking pictures on important occasions, in order to confirm that images are being recorded properly. Contax will not be held responsible for failure of photographs to be recorded or transmitted to a computer as the result of any defects in recording media (memory card).

<Storing the Camera>



CAUTION

- Store the camera in a well-ventilated location, avoiding damp or dusty areas, drawers or boxes containing mothballs, or in laboratories or other locations where chemicals are handled. Exposure to such chemical fumes can result in damage to camera circuitry, resulting in short circuits and causing the camera to emit smoke or catch fire.

- Do not place the camera in locations exposed to high temperatures for extended periods of time (the beach in summer, a closed car under bright sun, etc.). Such high temperatures may adversely affect or damage the camera, battery pack, or memory cards.
- Remove the battery pack before storing the camera for extended periods of time, to prevent battery leakage and resulting damage.

<Display Panel and LCD Monitor>



CAUTION

- Strongly rubbing or pressing against the LCD monitor screen can cause damage or other malfunctions. Use a blower brush to remove dirt or dust from the display panel or LCD monitor. In the event of severe soiling, wipe gently with a soft cloth or chamois.
- If the LCD monitor breaks, take precautions to prevent personal injury from glass fragments.
- If the LCD monitor breaks and its liquid contacts your skin, quickly wipe away any remaining liquid and wash the skin with soap and water. If the liquid should enter the eyes, wash with clean running water for at least 15 minutes, and then seek medical attention immediately.

- Due to the nature of LCD panels, a few pixels may appear permanently lit or may not light at all. This is not a malfunction, and does not affect the recorded image in any way.
- The LCD monitor may appear difficult to see in some outdoor lighting situations.

<Precautions for Handling Rechargeable Lithium Ion Battery Pack>



DANGER

- Do not charge or place battery pack near sources of high heat (near flames, heaters, or in direct sunlight, etc.), or in places exposed to flammable gases, since it may generate heat, emit smoke, or rupture.
- Do not allow the positive (+) and negative (-) terminals of the battery pack to be short-circuited by metallic wires or objects, since it may generate heat or emit smoke or flames.
- Do not store the battery pack together with keys, necklaces, coins or other metallic objects, since the objects may contact the battery pack terminals and short-circuit them.
- Do not try to heat the battery pack, or dispose of it in fire, since it may generate heat, emit smoke or flame, or rupture.

 DANGER	<ul style="list-style-type: none"> Do not attempt to disassemble or modify the battery pack, since it generate heat, emit smoke or flame, or the internal battery liquid may enter your eyes, causing blindness or other personal injury. Should battery liquid enter the eyes, wash them with clear running water and seek medical attention immediately. Use only the designated battery charger for charging the battery pack. Use of other charger may cause the battery pack to generate heat or smoke, catch fire or explode.
--	---

 WARNING	<ul style="list-style-type: none"> Never place the battery pack in a microwave oven or other container exposed to high-voltage, since battery liquid may leak, or the battery may generate heat, emit smoke or flame, or rupture. Do not use a leaking battery pack. Battery liquid may contact your skin, causing personal injury. In the event battery liquid does contact skin, wash immediately with clean water. Do not use broken or ruptured battery pack, since it may generate heat, emit smoke or flame, or cause electrical shock.
---	--

 CAUTION	<ul style="list-style-type: none"> Do not place the battery pack in water of any kind, or allow it to become wet, since it may generate heat, emit smoke or flame, or cause electrical shock. Do not use or attempt to recharge a wet battery pack, since it may generate heat, emit smoke or flame, or cause electrical shock. Do not store the battery pack in locations accessible to small children, since injury could result. Do not throw the battery pack or subject them to strong shocks, since it may be damaged and leak battery fluid. Whenever possible, use the battery pack at room temperature (20°C ± 5°C). The battery capacity and usable time between charging may be reduced in situations of extreme heat or cold, such as during mid-summer or deep winter weather, or when the battery pack is left in a hot location (e.g., inside a closed car exposed to sun). Such conditions may also shorten the usable service life of the battery pack. When not using the battery pack, store it in a cool, dry location.
---	---



Lithium-Ion Battery Pack.

Please recycle after use.

<Battery Charger and AC Adapter Handling Precautions>

 WARNING	<ul style="list-style-type: none"> Make sure that charger and AC adapter plugs are connected securely before use. Loose plugs and poor contacts can cause generation of heat, fire, and electrical shock. Do not attempt to modify the AC adapter cords, or subject them to unreasonable force. Damaged cords can cause fire and electrical shock. Discard cords whose wire cores are exposed and consult your dealer or Contax Service Center. Do not attempt to remove covers, disassemble, repair or modify your charger or AC adapter, since dangerous electrical shock could result. Charger or AC adapter plugs that have become laden with dirt or household dust should not be used, especially not in the vicinity of metal objects, since electricity might be transmitted through the metal, causing fire or electrical shock. If the plug is heavily soiled, disconnect it and clean it before reuse. In the event that a charger or AC adapter plug emits smoke, unusual smell or sound, or if it is damaged by impact or by being dropped, cease use immediately. Continued use of a damaged plug could result in fire danger. If a plug is damaged, consult your dealer or Contax Service Center. Do not connect the AC adapter to any sources of power other than a household AC outlet (AC 100-240V, 50/60Hz). Using the adapter with other voltages or ratings may cause a fire hazard or electrical shock.
---	---

 CAUTION	<ul style="list-style-type: none"> Use only the designated AC adapter and charger. Using other adapters or chargers may result in accidents and fire danger. Never attempt to splice the AC adapter cord, or subject it to severe twisting, bending, or stretching. Do not handle the charger or AC adapter with wet hands, since electrical shock could result. Always grasp the plug (not the cord) when removing the AC adapter plugs from camera and power outlet. Pulling the cord could cause breakage or wire damage, resulting in danger of fire or electrical shock. If you notice any damage to the charger or AC adapter, including broken wires and faulty plug contacts, discontinue use and consult your dealer or Contax Service Center.
---	--

- Prolonged use may cause the AC adapter to feel warm; this is only normal and not a malfunction.
- When not using the AC adapter for an extended period of time, first remove the plug from the camera, then disconnect the adapter from its AC outlet.

- If you wish to use the AC adapter while the battery pack is loaded in the camera, first set the camera's power switch to OFF, then connect the AC adapter before turning on the camera again.
- The AC adapter has been designed for exclusive use with this camera. To prevent the danger of fire and electrical shock, do not use the adapter with products other than the specific digital camera for which it was designed.



- * The SD logo is a trademark.
- * Microsoft and Windows are registered trademarks of Microsoft Corporation in the United States and other countries.
- * Macintosh, Mac OS, QuickTime™ and the QuickTime logo are the registered trademarks of Apple Computer Inc.
- * The PRINT Image Matching and PRINT Image Matching II technology are owned by Seiko Epson Corporation.
- * All other corporate and brand names are the registered trademarks or trademarks of their respective owners.

PRINT Image Matching

- * This product supports PRINT Image Matching II. Printing images on a printer that supports PRINT Image Matching II or image processing using supported software will most faithfully reproduce the colors of the original scene and the photographer's intent.

FCC COMPLIANCE STATEMENT FOR AMERICAN USERS

DIGITAL STILL CAMERA CONTAX TVs DIGITAL



Tested To Comply With FCC Standards

FOR HOME OR OFFICE USE

FCC Statement

This device complies with Part 15 of the FCC Rules. Operation is subject to the following two conditions:

(1) This device may not cause harmful interference, and (2) this device must accept any interference received, including interference that may cause undesired operation.

NOTE

This equipment has been tested and found to comply with the limits for a Class B digital device, pursuant to Part 15 of the FCC Rules. These limits are designed to provide reasonable protection against harmful interference in a residential installation.

This equipment generates, uses and can radiate radio frequency energy and, if not installed and used in accordance with the instructions, may cause harmful interference to radio communications. However, there is no guarantee that interference will not occur in a particular installation. If this equipment does cause harmful interference to radio or television reception, which can be determined by turning the equipment off and on, the user is encouraged to try to correct the interference by one or more of the following measures:

- Change the direction of the radio or TV antenna. Move the equipment or the radio or TV. For example, if the equipment is to the right of the TV, move it to the left of the TV. Or, move the equipment farther away from the radio or TV.
- Plug the equipment into a different outlet. Do not plug your radio or TV into the same circuit as your equipment.
- Ensure that all expansion slots (on the back or side of the equipment) are covered. Also, ensure that all metal retaining brackets are tightly attached to the equipment.
- If these suggestions do not help, consult your equipment dealer or experienced radio/TV technician for help.

CAUTION

If you modify the camera in any way, without getting approval from KYOCERA CORPORATION, your camera may violate FCC regulations. Violation of FCC regulations may cause the FCC to void your right to use the modified camera.

Shielded cables must be used for this equipment to comply with the relevant FCC regulation.

For customers in Canada CAUTION

This Class B digital apparatus complies with Canadian ICES-003.

Cet appareil numérique de la classe B est conforme à la norme NMB-003 du Canada.

Names of Parts

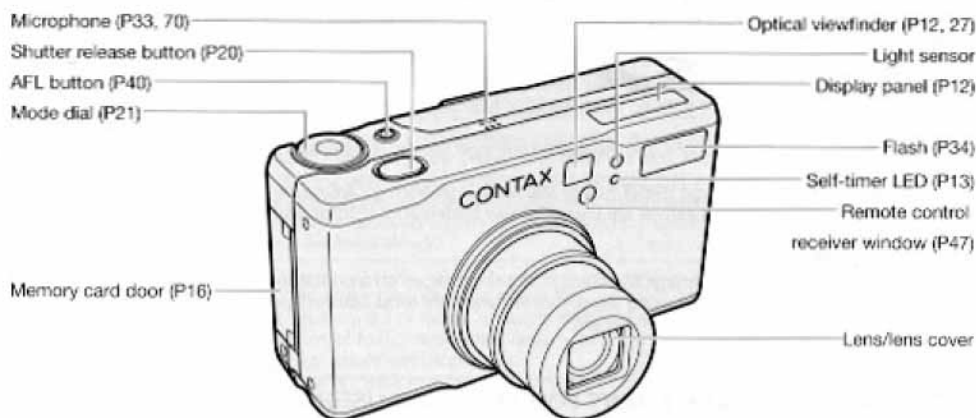

USB out connector (P98)

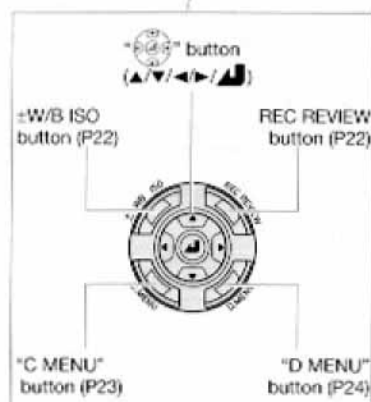
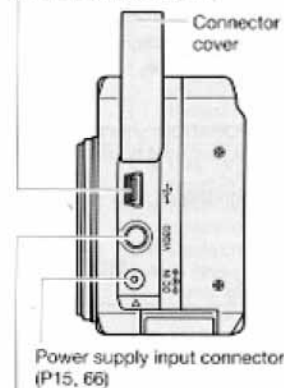

Memory card insertion slot (P16)



LCD Monitor Indications (Photography Mode)

Still photography mode

In this diagram all icons are shown on the LCD monitor. In actual use, the icons that appear depend on made settings.

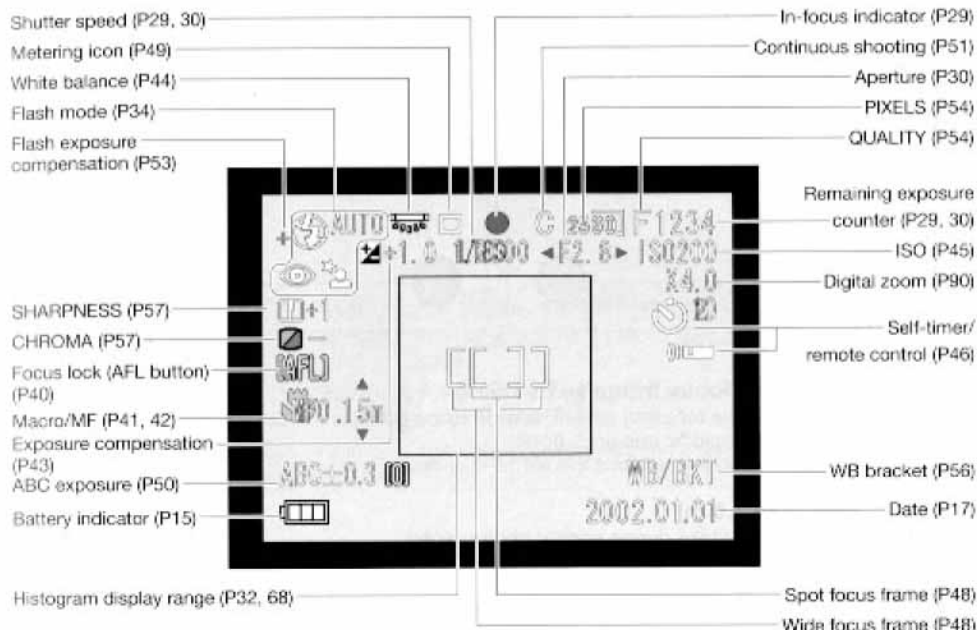

Movie mode

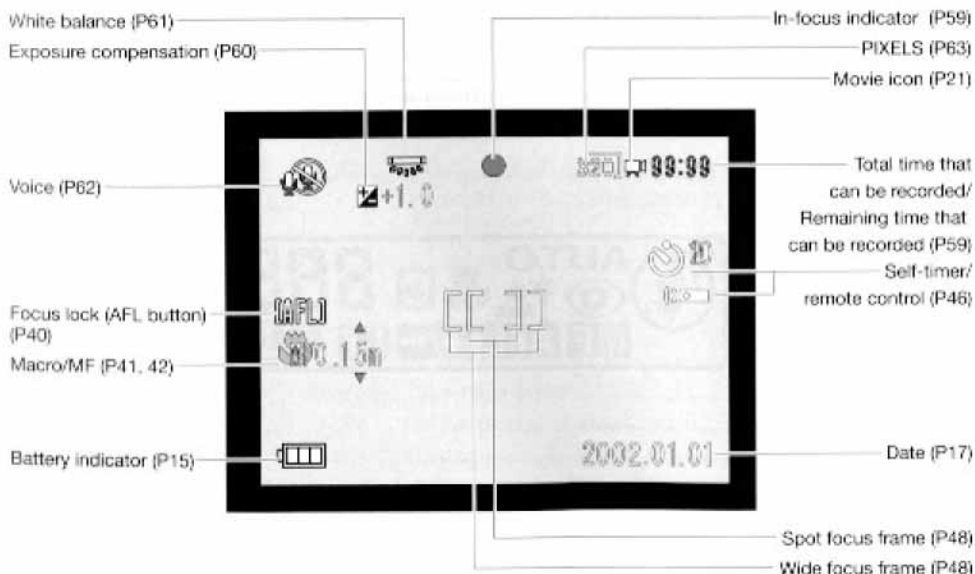

Viewfinder Display and Display Panel

Viewfinder Display

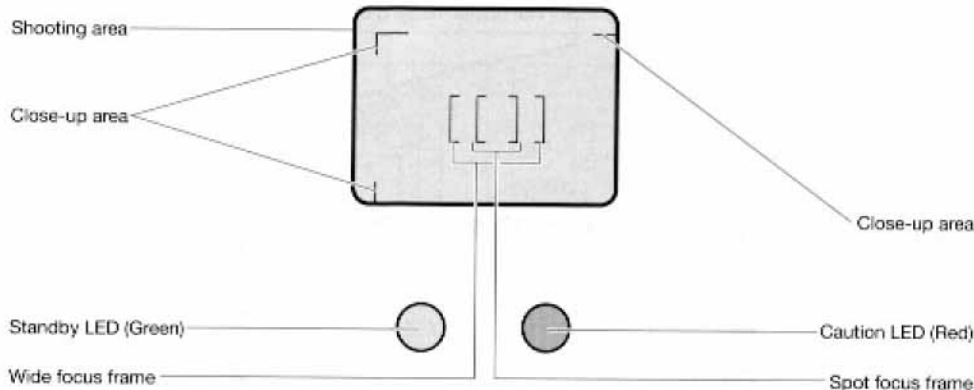

Wide focus and spot focus frame (∞ to 1.5 m)

These indications show the focusing area. The wide focus frame is the default setting. Use the spot focus frame to focus on specific subjects. (P48)

- Use the LCD monitor to focus on subjects that are 1.5 m or closer.

Shooting area (∞ to 1.5 m)

This area shows what you take during normal photography.

Close-up area (1.5 to 0.6 m)

This area shows the area of the subject that you capture during close-up photography. Use the LCD monitor for macro photography.

Display Panel

In this diagram all icons are shown on the display panel. In actual use, the icons that appear depend on made settings.

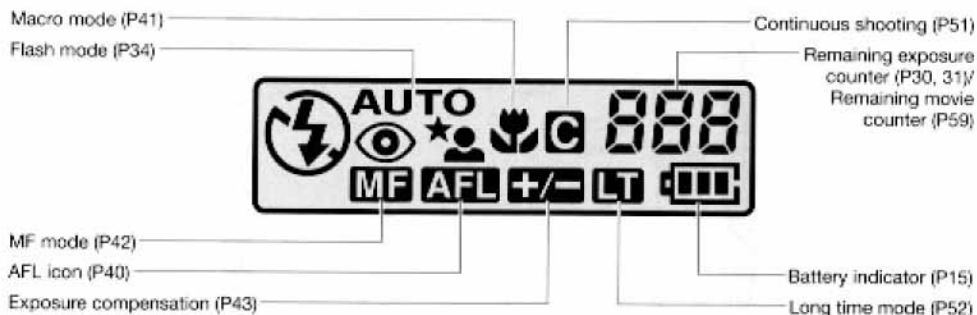

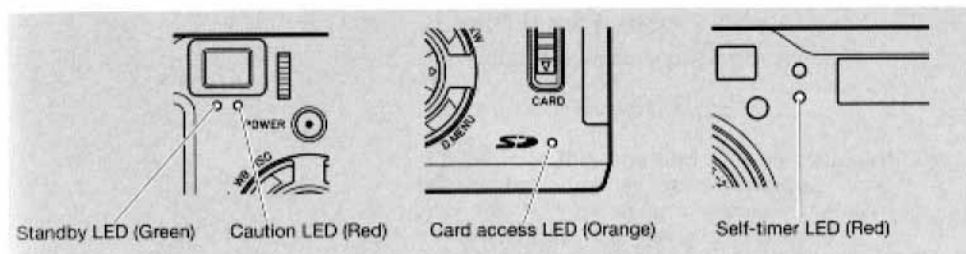

Standby LED (Green)

"Movie, Av, P" modes	On	The subject is in focus and a photograph can be taken.
	Flashing	The subject is not in focus, but a photograph can be taken.
	Flashes twice	When the remote control sensor receives the remote control signal (P47).
During battery pack charging	On	The battery pack has been charged.

Caution LED (Red)

"Movie, Av, P" modes	Fast flashing	Sets a slow shutter speed. Take care to avoid camera shake.
	Slow flashing	The flash is charging. Wait until flashing stops before taking the picture.
During battery pack charging	On	Battery pack charging
	Flashing	The battery pack, AC adapter or camera is malfunctioning.

Card access LED (Orange)

"Movie, Av, P, Play, SETUP" modes	Flashing	Indicates that the memory card is being accessed. For example, data is being saved to or read from the memory card.
-----------------------------------	----------	---

- The memory card door must not be opened and the memory card must not be removed when the LED is flashing.

Self-timer LED (Red)

"Movie, Av, P" modes	Flashing	Self-timer is on
	ON	In still picture or movie mode
"Play, SETUP" modes	ON	In play mode or SETUP mode
"PC"	Flashing	When connected to a PC

Preparations and Operating Checks

Preparations Before Shooting

1. Loading and Charging the Battery Pack

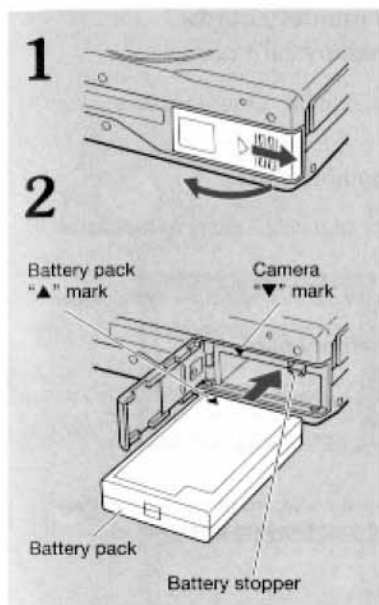

<Loading the battery pack>

1 Open the battery pack cover.

Slide it open as shown in the figure.

2 Slide in the supplied battery pack until the battery stopper locks in place.

Align the "▼" mark on the camera with the "▲" mark on the battery pack to ensure correct loading.

- The battery pack cannot be charged if it is loaded upside-down.

3 Close the battery pack cover.

<Removing the battery pack>

Release the battery stopper lock to remove the battery pack.

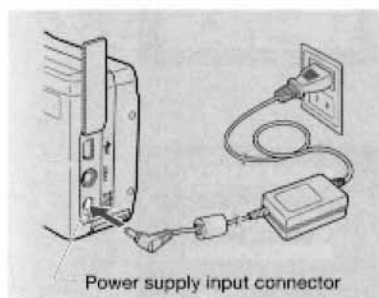

<Charging the battery pack>

Load the battery pack in the camera, connect the supplied AC adapter to the power supply input connector on the camera.

- Make sure that the camera is turned off before charging.

It takes about 6 hours to charge the battery pack. The Caution LED (Red) is lit during charging. When the battery pack is fully charged, the Caution LED goes out and the Standby LED (Green) lights.

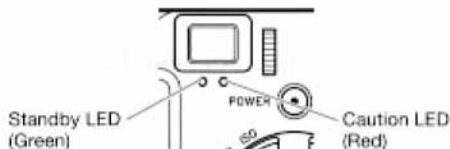

<Charging status>

Use the battery indicator on the LCD monitor to check whether or not the battery pack needs to be charged.



Sufficient battery power



Half of the battery power has been used.



Battery power is low. Time to charge.



No remaining charge and camera does not operate. Charge the battery pack.

2. Installing and Removing the Memory Card

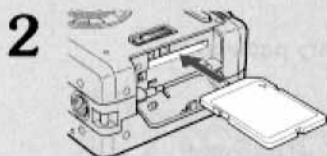
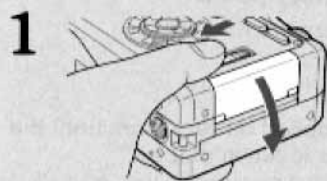

<Card removal>

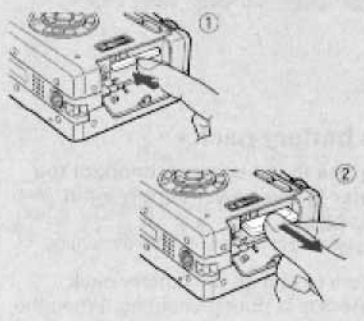

<Installing the memory card>

1 Open the memory card door.

Slide the memory card door release to open the card door.

2 Insert the memory card.

Slide in the memory card until it stops with a secure click.

- Take care to insert the memory card in the right direction.

3 Close the memory card door.

- Do not attach a seal, etc. on the memory card. If you do so, you may not be able to remove the memory card.

<Removal>

① Gently press the memory card to eject it and take it out holding the edges of the card as shown at ② in the illustration.

<SD card write protect switch>

Write protect switch

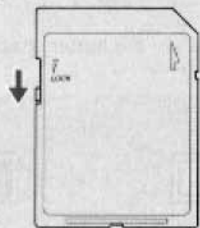

As shown in the illustration, an SD memory card is provided with a write protect switch.

When this switch is moved down, further recording on the card is disabled to protect any images and data already on the card. In this status, images cannot be recorded and images on the card cannot be erased. The LCD monitor will display "WRITE PROTECT".

3. Setting the Time and Date

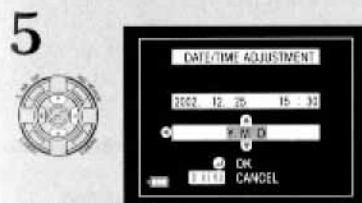
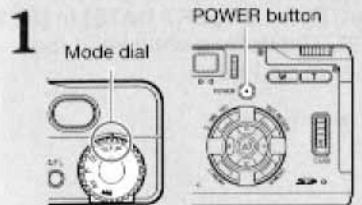

Follow these instructions to set the date and the calendar.

1 Set the mode dial to "SETUP" and press the POWER button.

The power goes on and the LCD monitor enters the [SET UP] mode.

2 Press the "D MENU" button to display the [SET UP D] screen.

3 Use "▲" or "▼" on the "D MENU" button to select [DATE] and press the "▶" button.

The LCD monitor enters the [DATE/TIME ADJUSTMENT] mode.

4 Press the "◀" or "▶" button to select the item to change and press the "▲" or "▼" button to change the numerical value.

- The time is displayed according to the 24-hour clock.

5 Press the "▶" button and select [Y.M.D].

To change the [Y.M.D], order press the "▲" or "▼" button. You can select Year-Month-Day, Month-Day-Year or Day-Month-Year.

- Pressing the "D MENU" button cancels the setting.

6 Press the "▲" button to complete the setting.

The LCD monitor returns to the [SET UP] mode.

Be sure to set the time and date.

A digital camera stores images with the date and time on a memory card and this makes it easier to process the images on a computer and place them in an album.

4. Imprinting the Date (Still Mode)



You can imprint the date on an image by setting [WITH DATE] for [INSERT DATE] in [SET UP D] on page 89. The date is entered in the lower right corner of an image.

- An imprinted date cannot be erased.

5. Adjusting the Diopter

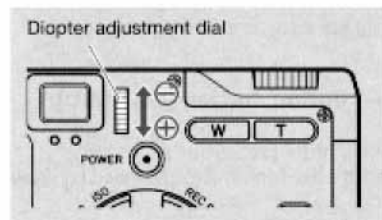

This camera has a built-in diopter mechanism. Turn the diopter adjustment dial until you can see the focusing frame clearly.

The adjustable range is -3.0 to $+1.0$ D (diopter).

6. Holding the Camera

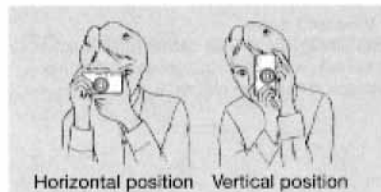

- ① Keep your elbows tucked in to stabilize the camera.
- ② Hold your breath when you press the shutter release button.
- ③ Keep your arms and hands relaxed and press the shutter release button gently.

It is important to hold the camera firmly to take sharp photographs. Camera shake is the most common cause of poorly focused photographs.

Practice with the camera to find the most comfortable positions for you to make vertical and horizontal compositions. Propping yourself against a building or a tree can often be effective.

- Make sure that the strap or your fingers do not get in the way of the lens, light sensor or the flash.
- Placing the flash at the top during vertical composition produces a photograph with a lighting that more closely resembles a daylight shot.
- Be sure not to touch the lens when you hold the camera.

Preparations and Operating Checks

Basic Operations

1. POWER button

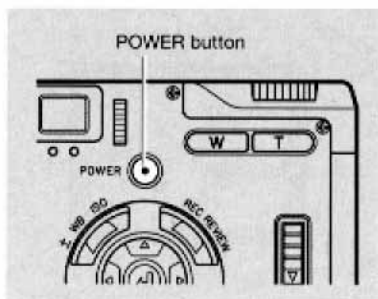

The POWER button turns the camera ON and OFF.

When the power is turned on, a beep is heard and the start screen appears on the LCD monitor. Pressing the button once more turns the power off.

- If you wish, you can set up the camera so that the start screen does not appear. (P90)

2. Shutter Release Button

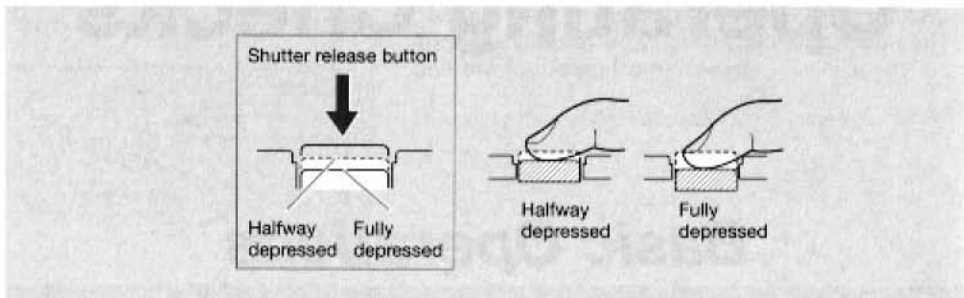

The shutter release button has two positions. The first position is referred to as "halfway", the second position, or "fully depressed" is achieved by pressing the shutter release button all the way down. These shutter release button positions have the following functions.

Halfway

Focuses the lens and measures exposure.

Fully depressed

The shutter is released and the picture is taken.

* To prevent camera shake, place your index finger firmly on top of the button and press it gently. Be sure to read the section on how to hold the camera (P18).

- The sound of the shutter (SHUTTER VOL) heard when the shutter is released can be adjusted on this camera. (P90)

3. Zoom Button

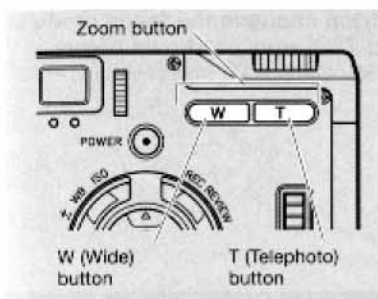

Photography (Movie, Av, P) mode:

In the above modes, the zoom button can be used to set the optical zoom or digital zoom (X1.3, X1.6, X2.0, X3.0 and X4.0).

"Playback" mode:

Use the button to toggle between normal playback and enlarged playback (X2, X4). (Still photography only)

Digital zoom

- The digital zoom uses interpolation to enlarge the image. Note that picture quality deteriorates as images are enlarged.
- Use the LCD monitor to view digital zoom images. The optical viewfinder cannot be used to view digital zoom images.
- Only "Av" and "P" modes are available during digital zoom operation.

4. Mode Dial

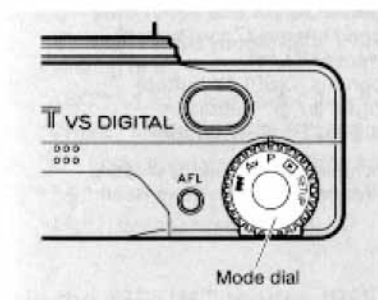

The mode dial allows you to select the following modes.

- ① "Movie" (movie) mode (P59)
- ② "Av" (aperture-priority auto) mode (P30)
- ③ "P" (program auto) mode (P29)
- ④ "Playback" (playback) mode (P66)
- ⑤ "SETUP" mode (P86)

5. "Flash/Rec" Button

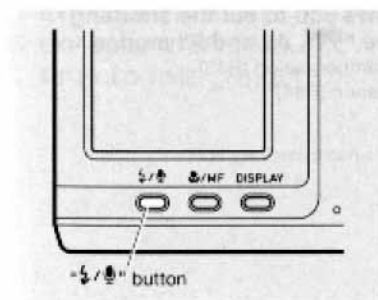

This button is used to make the following settings.

- In "Av, P" mode: Use to switch between different flash modes. (P34)
- In "REC REVIEW": Use to enter the recording mode. Use the "Flash" button to stop and start recording. (P33)
- "Play": Use to change still picture playback to recording mode. (P70)

6. "🌸 / MF" Button

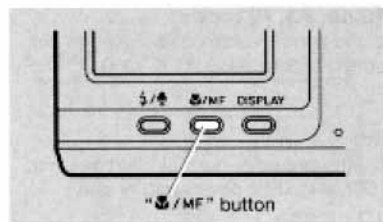

The "🌸 / MF" button changes the focus mode in the "🌸, Av and P" modes as shown below.

AF (auto focus) → Macro AF → MF (manual focus) → AF (and back)

7. REC REVIEW Button

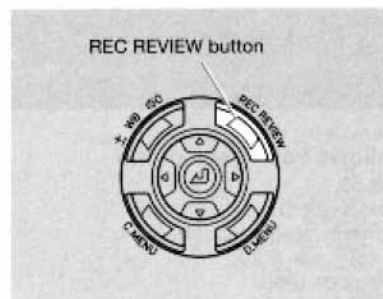

This button allows you to check a recorded image in the "Av, P" modes. Press the REC REVIEW button to display the last image shot when the power was on.

It also allows you to perform the functions listed below while viewing images. (P32)

- ① Displaying enlarged images (Zoom button)
- ② Displaying information (▲/▼)
- ③ Displaying histograms (DISPLAY button)
- ④ Making recordings ("📷 / 🎤" button)
- ⑤ Deleting images (REC REVIEW button)

● REC REVIEW is not available during movie shooting.

8. ±WB ISO Button

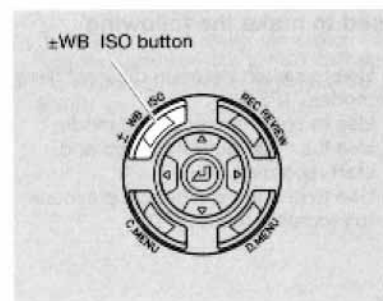

This button allows you to set the shooting conditions in the "🌸, Av and P" modes.

- ① "±" exposure compensation (P43)
- ② "WB" white balance (P44)
- ③ "ISO" (P45)

● ISO cannot be set when movies are shot.

9. "C MENU" Button

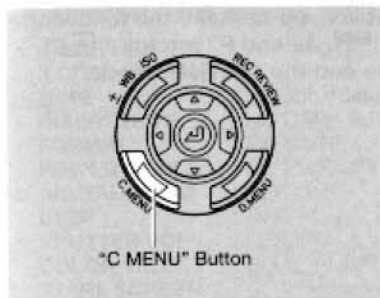

This button allows you to set the shooting conditions in the "M", Av and P" modes and the "SETUP" mode.

- is the default mode.

<In the "M" mode>

- 1 "⏱" self-timer, remote control photography: OFF, 10 sec, 2 sec, 0 sec (P61)
- 2 "AF" auto focus and focus frame setting: "[]" spot, "[]" wide (P62)

<In the "Av, P" modes>

- 1 "⏱" self-timer, remote control photography: OFF, 10 sec, 2 sec, 0 sec (P46)
- 2 "AF" auto focus and focus frame setting: "[]" spot, "[]" wide (P48)
- 3 "METERING" mode: "☒" evaluative metering, "◼" spot metering, "◻" center-weighted metering (P49)
- 4 "ABC": no compensation (0.0), ±0.3, ±0.5, ±1.0 (P50)
- 5 "DRIVE" mode: "S" single-frame mode, "C" continuous shooting mode (P51)
- 6 "LT" (long time) exposure time setting: OFF, 1 sec, 2 sec, 4 sec, 8 sec (P52)
- 7 "± 1/2" flash exposure compensation: "- 1/2" (- compensation), "1/2" (no compensation), "+ 1/2" (+ compensation) (P53)

<In the "SETUP" mode> (P88 - 89)

- 1 **DEFAULT FLASH** (flash mode set when the camera is turned on): 1/2 AUTO (Auto flash mode), 1/2 Ⓞ AUTO (Red-eye reduction auto flash mode), 1/2 OFF (Flash-off mode), 1/2 (Fill-in flash mode), 1/2 Ⓞ AUTO (Night portrait flash mode)
- 2 **ABC**: (0) (standard)/+ (over)/- (under), + (over)/(0) (standard)/- (under)
- 3 **AFL HOLD TIME**: 1 FRAME ONLY, UNTIL OFF
- 4 **AFL FUNCTION**: AF LOCK, AF-AE LOCK
- 5 **EXP COMP TIME**: UNTIL OFF, UNTIL CANCEL
- 6 **EXP COMP STEP**: 0.3 EV, 0.5 EV
- 7 **MF HOLD TIME**: UNTIL OFF, UNTIL CANCEL

10. "D MENU" Button

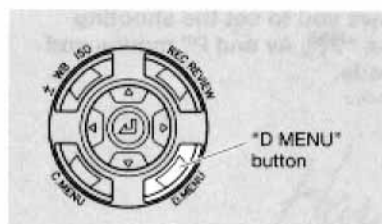

This button enables you to make the following settings in the "M", Av and P modes, "▶" (Playback) mode and the "SETUP" mode.

● is the default mode.

<In the "M" mode>

- ① "SOUND" **SOUND**: ON, OFF (P62)
- ② "COLOR" mode: COLOR, B/W (black and white), SEPIA (P63)
- ③ "PIXELS": "320" 320 x 240, "160" 160 x 120 (P63)

<In the "AV, P" modes>

- ① "COLOR" mode: COLOR, B/W (black and white), SEPIA (P54)
- ② "PIXELS": "2560" 2560 x 1920, "1600" 1600 x 1200, "1280" 1280 x 960, "640" 640 x 480 (P54)
- ③ "QUALITY (compression ratio)": FINE, NORMAL (P54)
- ④ "WB/BKT" WB bracket: ON, OFF (P56)
Note: WB bracket cannot be combined with ABC.
- ⑤ "SHARPNESS": -1, 0 (STANDARD), +1, +2, +3 (P57)
- ⑥ "CHROMA": -, 0 (STANDARD), + (P57)

<In the "▶" mode>

- ① Playback screen display: "■" (SINGLE) single image playback, "▣" (MULTI) multiple image playback (6 images) (P69)
- ② "RECORDING" (still photography only) (P70)
- ③ "PROTECT": SET, SET (cancel) (P72)
- ④ "ERASE" (P73)
- ⑤ "ERASE ALL" (P73)
- ⑥ "RESIZE" (still photography only) (P74)
- ⑦ "ROTATE": Rotate 90° to the left "↶ 90°", rotate 90° to the right "↷ 90°" (not during multiple playback) (still photography only) (P76)
- ⑧ "AUTO PLAY" (P77)
INTERVAL (2 SEC, 10 SEC, 15 SEC and 30 SEC)
START FRAME (1ST FRAME, THIS FRAME)
- ⑨ "SETTING PRINT (DPOF menu screen): (still photography only) (P78)
 - 1) PRINT
 - 2) INDEX
 - 3) ALL RESET

<In the "SETUP" mode> (P89 - 91)

- ① **BRIGHT CNTRL (LCD luminance)** : +2, +1, STANDARD, -1, -2
- ② **DATE** : Set according to provided instructions. (P17)
- ③ **INSERT DATE** : NO DATE, WITH DATE
- ④ **FORMAT** : EXECUTE, CANCEL
- ⑤ **POWER SAVE** : NO PWR OFF, 1 MIN., 3 MIN., 6 MIN.
- ⑥ **DIGITAL ZOOM** : OFF, ON
- ⑦ **BEEP** : OFF, +1, +2, +3
- ⑧ **SHUTTER VOL** : OFF, +1, +2, +3
- ⑨ **COLOR SELECT** : BLUE, PURPLE, RED, YELLOW
- ⑩ **START SCREEN** : CONTAX screen, User setting, OFF
- ⑪ **AUTO PLAYBACK** : OFF, 2 SEC, 4 SEC
- ⑫ **LANGUAGE** : JAPANESE, ENGLISH, FRANÇAIS, DEUTSCH, ESPAÑOL
- ⑬ **VIDEO OUT** : NTSC, PAL
- ⑭ **FILE NO.** : EXECUTE, CANCEL
- ⑮ **MODE RESET** : EXECUTE, CANCEL

11. AFL Button

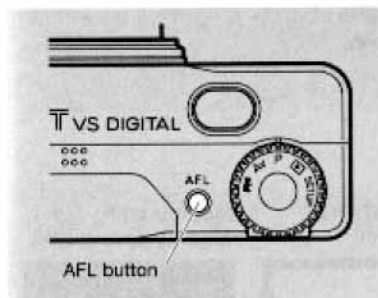

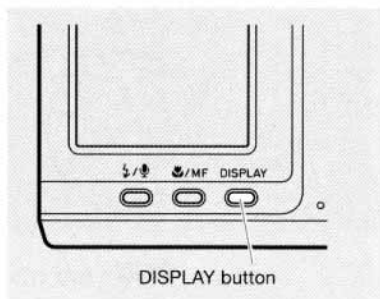

You can use the AFL button to lock the focus. This allows you to concentrate on the task at hand: pressing the shutter release button to take the picture. (P40)

12. DISPLAY Button



This button switches the LCD monitor as described below.

- “AV, P”:
INFORMATION display ON → INFORMATION + Histogram display → INFORMATION display OFF → Monitor OFF
- “”:
INFORMATION display ON → INFORMATION display OFF → Monitor OFF
- “”:
Histogram display ON, OFF (still photography only)

“AV, P”

INFORMATION display ON



Shows a number of settings such as white balance, exposure compensation, ISO and sharpness.

INFORMATION + Histogram

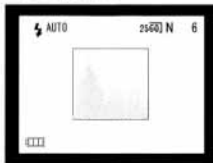

Shows INFORMATION display and histogram. When the shutter release button is pressed halfway down, the histogram is replaced by the focus frame (excluding when LT is set).

INFORMATION display OFF

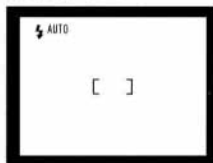

Shows only the flash symbol and focus frame (in-focus icon). However, LT, C, ABC, WB/BKT and self-timer symbols also appear if set.

Monitor OFF (Energy save mode)



“”

INFORMATION display ON

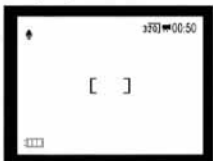

Shows a number of settings.

INFORMATION display OFF



The self-timer, if set, is indicated.

Monitor OFF (Energy save mode)



- When the power is turned on, the camera starts in the mode it had when it was last turned off. However, if the camera is turned off in the Monitor OFF mode, it starts in the INFORMATION display ON mode.

13. Optical Viewfinder

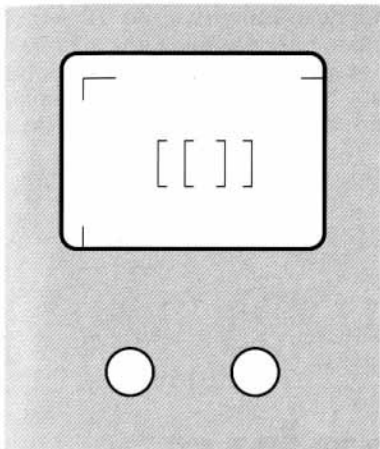

When you are on a trip or in a situation where you cannot easily charge the battery pack, it is recommended that you turn off the LCD monitor and instead use the optical viewfinder to conserve battery power. (P12)

<Parallax>

Parallax is the difference between the image produced by the optical viewfinder and the image captured by the camera. This difference is particularly noticeable at close distances. Use the LCD monitor for taking macro photographs.

- When the macro mode is entered, the LCD monitor, if off, is automatically turned on.

Photography

Simple Still Photography Procedure

1. "P" Program Auto Function

In the "P" program auto-exposure mode, the camera automatically sets the combination of the shutter speed and aperture (the exposure value) according to the brightness of the subject. We recommend using this mode if you are using a camera for the first time or if you want to take photos without worrying about the aperture and shutter speed settings.

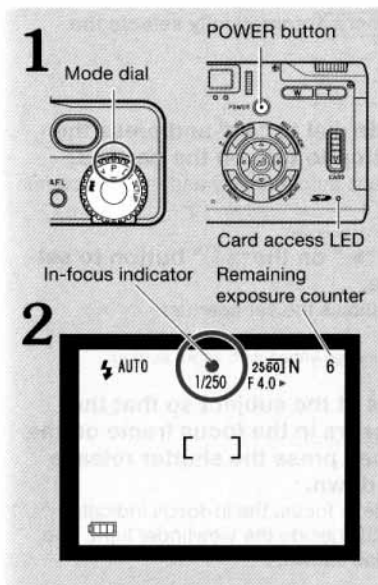

1 Set the mode dial to "P" and press the POWER button to turn on the camera.

The lens cover opens automatically and the lens comes out.

2 Aim the lens at the subject so that the subject appears in the focus frame on the LCD monitor and press the shutter release button halfway down.

When the subject is in focus, the in-focus indicator ("○") and the standby LED beside the viewfinder light. The shutter speed and aperture are also indicated.

- A flashing 1/2000 shutter speed indicates overexposure.

3 When you have confirmed that the in-focus indicator ("○") lights, fully depress the shutter release button to take the picture.

The captured image is stored on the memory card. The memory card access LED flashes during image storage.

- You can still depress the shutter release button even if the in-focus indicator ("○") flashes.

Program auto control diagram (ISO 100)

Wide (7.3 mm)

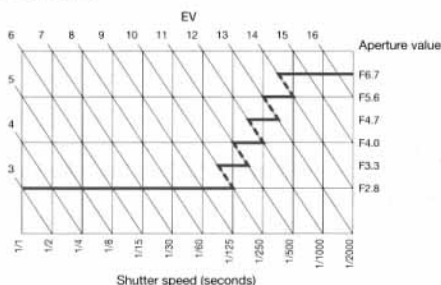

Telephoto (21.9 mm)

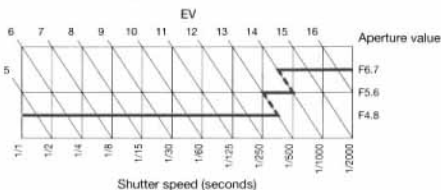

- When there is no more space left on the memory card, "MEMORY CARD FULL" is indicated on the LCD monitor, the remaining exposure counter on the display panel will show a flashing "000" and the shutter release button cannot be depressed. Replace the memory card with one that is empty or has enough free space left.
- While the memory card access LED flashes, the camera is writing an image to the card. To prevent corruption of the data and damage to the camera, make sure that none of the following occurs while the LED is flashing.
 - The camera is exposed to vibration or shock.
 - The memory card door is opened.
 - The battery pack is removed or the power is turned off.
- * The combinations of the aperture and shutter speed in the program auto mode are shown in the diagram.

2. "Av" Aperture-Priority Auto

It is a characteristic of the lens that when a subject is in focus not only the subject itself but also an area behind and in front of the subject are sharp. This is referred to as depth of field.

The area that is sharp increases with smaller apertures and decreases with larger apertures. You can use this either to make sure that both the subject and the background are in focus or that only the subject is sharp while the background is blurred. Set the aperture that suits the purpose of the picture you are composing.

In aperture-priority auto, you set the aperture and the camera automatically selects the shutter speed according to the brightness of the subject.

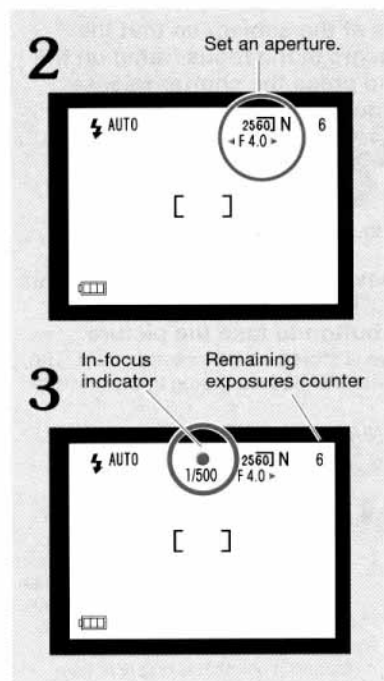

1 Set the mode dial to "Av" and press the POWER button to turn on the camera.
The lens cover opens automatically and the lens comes out.

2 Use "◀" or "▶" on the "⊙" button to set the aperture.
The LCD monitor shows the set aperture.

- Available aperture range varies with zoom setting.

3 Aim the lens at the subject so that the subject appears in the focus frame on the LCD monitor, then press the shutter release button halfway down.

When the subject is in focus, the in-focus indicator ("○") and the standby LED beside the viewfinder light. The shutter speed is also shown.

- When appropriate exposure cannot be achieved at 1/2000 sec, the camera automatically sets the appropriate aperture.
- A flashing 1/2000 shutter speed indicates overexposure.

4 When you have confirmed that the in-focus indicator ("○") is lit, fully depress the shutter release button to take the picture.

The captured image is stored on the memory card. The memory card access LED flashes during image storage.

- You can still depress the shutter release button even if the in-focus indicator ("○") flashes.
- When there is no more space left on the memory card, "MEMORY CARD FULL" is indicated on the LCD monitor, the remaining exposure counter on the display panel will show a flashing "000" and the shutter release button cannot be depressed. Replace the memory card with one that is empty or has enough free space left.
- While the memory card access LED flashes, the camera is writing an image to the card. To prevent corruption of the data and damage to the camera, make sure that none of the following occurs while the LED is flashing.
 - The camera is exposed to vibration or shock.
 - The memory card door is opened.
 - The battery pack is removed or the power is turned off.

Aperture-priority auto control diagram (ISO 100)

Wide (7.3 mm)

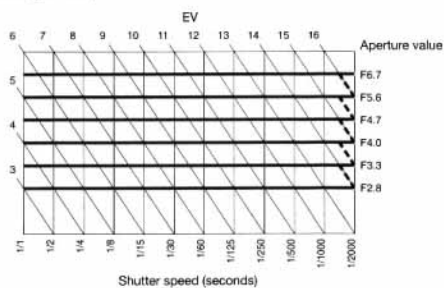

Telephoto (21.9 mm)

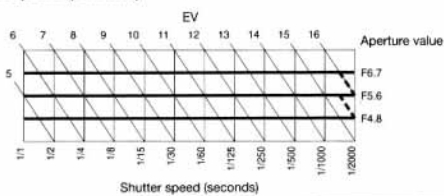

3. Confirming and Erasing Images (REC REVIEW button)

Normal image



Enlarged image



INFORMATION screen

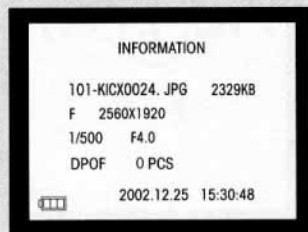

Histogram

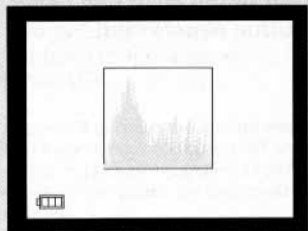

<Checking a recorded image>

The REC REVIEW button allows you to check the most recent image you took on the LCD monitor when the camera was on.

In combination with other buttons, you can also do the following.

- 1 Enlarge the image (x2, x4)
- 2 Display INFORMATION (shooting data)
- 3 Display histograms (brightness distribution)
- 4 Make recordings (voice recording)
- 5 Delete images

The camera returns to the exposure screen when the shutter release button is pressed halfway down during REC REVIEW.

- The camera can be set up so that images are automatically displayed as they are taken. (AUTO PLAYBACK: P90)

1 Playback zoom (x2, x4)

In REC REVIEW, use the "T" zoom button to enlarge the image you view (x2, x4).

Use "▲/▼/◀/▶" on the "INFO" button to scroll the image to view image areas not visible in the monitor.

- Use the "W" zoom button to return to the original view of the image.

2 Displaying INFORMATION

In REC REVIEW, use "▲" or "▼" on the "INFO" button to display the aperture, shutter speed and other shooting data regarding the image (refer to P68).

- Press "▲/▼" again to hide the information display.

3 Histogram (brightness distribution)

In REC REVIEW, use the DISPLAY button to view a histogram.

- Press the DISPLAY button again to hide the histogram.

A histogram is a graph showing the distribution of brightness in a recorded image. The higher the histogram is towards the left side the darker the image is, while the higher it is towards the right side the brighter it is. (The horizontal axis shows pixel brightness, while the vertical axis shows the number of pixels of equal brightness.)

- Set the exposure compensation towards the + end for a dark image and towards the - end for a bright image, then take the picture again.

1



4

Voice recording icon

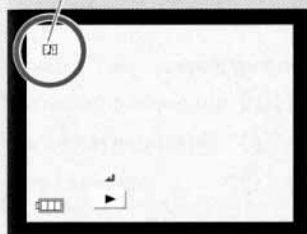

④ Making recordings (voice recording)

Recorded messages or comments can be added to a still picture.

1 Press the “” button in REC REVIEW. [RECORDING] appears on the LCD monitor.

2 Press “▲” on the “” button to select [EXECUTE] and press the “” button to start recording. Speak into the microphone to record a message.

You can record a message up to 30 seconds; the LCD monitor shows the remaining time of recording.

3 To stop the recording, press the “” button again.

4 To playback the recorded voice memo, press the “” button again.

- Use “▲/▼” on the “” button to adjust the volume.
- You cannot delete or rerecord a recording in the REC REVIEW screen.

1

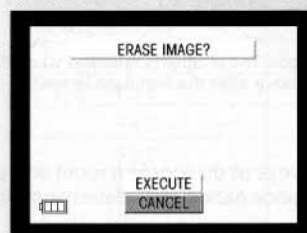

2

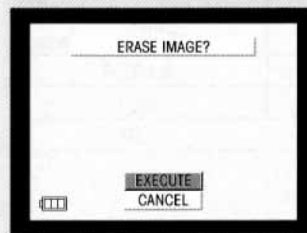

⑤ Deleting images

Images that are no longer needed can be deleted.

1 In REC REVIEW, press REC REVIEW button to enter erase mode.

2 Press “▲” on the “” button to select [EXECUTE] and press the “” button. The image is erased and camera returns to the photography screen.

- An erased image cannot be restored so take care when erasing images.

4. Flash Photography

The camera allows you to select the flash mode that you think best suits the image or the scene. In the P or Av exposure mode, use the “/” button to cycle through the different flash modes shown on the display panel and the LCD monitor as shown below. Select the desired flash mode.

① Auto flash mode → ② Red-eye reduction auto flash mode → ③ Flash-off mode
→ ④ Fill-in flash mode → ⑤ Night portrait flash mode

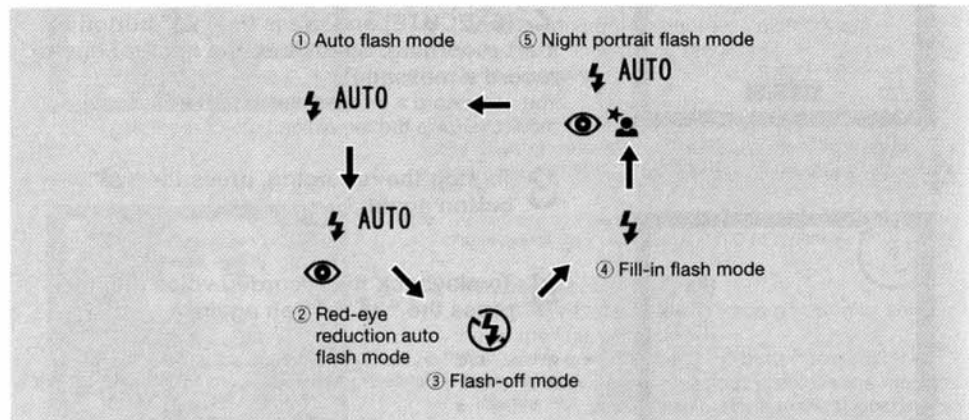

<1. Auto Flash Mode> “ AUTO”

The camera is automatically set to flash exposure mode when the scene is so dark that a shutter speed lower than 1/60 sec is required. The shutter speed is then set to 1/60 sec.

<2. Red-eye Reduction Auto Flash Mode> “”

This mode reduces the red-eye effect that a flash can sometimes cause in photos of people.

- In this mode, two flashes are fired with a 0.8 second interval between them. The shutter is released when the second flash is fired. Be sure not to move the camera or let the subject move after the first flash is fired.

<3. Flash-off Mode> “”

Use this mode when you want to capture the mood a subject conveys at dusk or in a room and you do not want the flash to fire. This mode provides a natural image since exposure is determined by the light on the subject.

- Shooting in dark places requires a slow shutter speed (up to 1 sec) and use of a tripod is recommended to prevent camera shake.

<4. Fill-in Flash Mode> “”

In this mode, the flash fires regardless of ambient light conditions.

When you are taking photos outside in strong sunlight or subjects that are backlit, the subject may often become dark. In this situation, the fill-in flash mode lightens the shadows to produce photos with clearly lit subjects and backgrounds. (daylight sync exposure)

- When the subject is dark and a shutter speed slower than 1/60 sec is required, the shutter speed is set to 1/60 sec.



<5. Night Portrait Flash Mode> “ AUTO”



Use this mode to take pictures of people at dusk or in a night scene when you want the background to appear in the photo.

Since this mode is combined with the red-eye reduction mode, the shutter speed can become as slow as 1 sec. (Slow sync exposure)

- Use of a tripod is recommended to prevent camera shake for the slow shutter speeds used by slow sync exposure.

- Available flash modes depend on camera modes as shown below.

“C” continuous shooting: “” (flash-off mode) ↔ “” (fill-in flash mode)

“LT” longtime exposure: “” (flash-off mode) ↔ “ AUTO” (red-eye reduction auto flash mode)

“” macro mode: “” (flash-off mode) ↔ “” (fill-in flash mode)

<Flash Range>

ISO: AUTO

Wide (7.3 mm)

Exposure/aperture	Distance (m)					
	0.6	1	2	3	4	5
P, F2.8	[Flash range bar from 0.6 to 3.0]					
F3.3	[Flash range bar from 0.6 to 2.5]					
F4.0	[Flash range bar from 0.6 to 2.0]					
F4.7	[Flash range bar from 0.6 to 1.8]					
F5.6	[Flash range bar from 0.6 to 1.5]					
F6.7	[Flash range bar from 0.6 to 1.2]					

Telephoto (21.9 mm)

Exposure/aperture	Distance (m)					
	0.6	1	2	3	4	5
P, F4.8	[Flash range bar from 0.6 to 1.8]					
F5.6	[Flash range bar from 0.6 to 1.5]					
F6.7	[Flash range bar from 0.6 to 1.2]					

ISO: 100, 400

Wide (7.3 mm)

□ ISO100 ■ ISO400

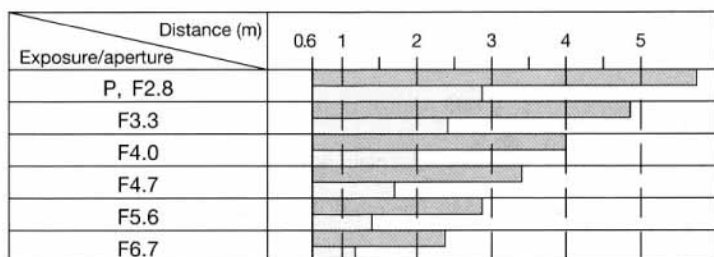

Telephoto (21.9 mm)

□ ISO100 ■ ISO400

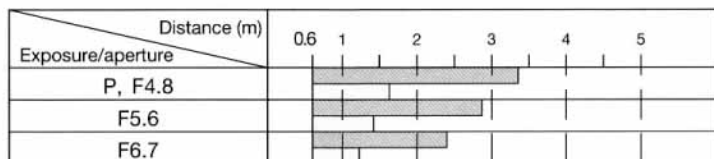

<DEFAULT FLASH>

The flash mode set when the camera is turned on can be changed.

To have the camera ready at all times, set "☺", "⚡ AUTO" or other flash mode you most often use. For details, see Section "Setup Menu Contents" on P88.

<Flash exposure compensation>

You can set flash exposure compensation. For details, see P53.

Photography

Still Photography Techniques

PIXELS and QUALITY

Pixels are the dots that make up an image. More dots produce images with a higher resolution but the resulting image files are larger meaning that fewer files can be stored on the memory card. **Quality is the compression ratio used when digitizing captured image data.** "FINE" uses a low compression ratio to minimize corruption of image details. "NORMAL" uses a higher compression ratio that produces lower quality images but means that more images can be stored on a memory card.

- For details on how to set the number of pixels and quality, refer to page 54.

Number of images that can be recorded on a 16 MB memory card

PIXELS	QUALITY	
	"F" FINE	"N" NORMAL
"2560"] 2560x1920	Approx. 4 – 6	Approx. 8 – 12
"1600"] 1600x1200	Approx. 10 – 15	Approx. 20 – 29
"1280"] 1280x960	Approx. 16 – 23	Approx. 30 – 43
"640"] 640x480	Approx. 54 – 73	Approx. 88 – 112

1. Focus Lock Photography

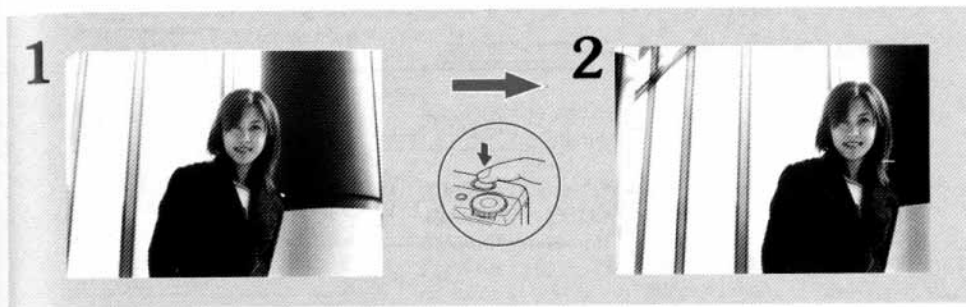

Press the shutter release button halfway down to focus the subject. The in-focus indicator ("O") lights and the focus is locked (focus lock). Focus is locked as long as the shutter release button is halfway depressed and does not change even when you move the camera.

Use the focus lock function when the composition forces you to place the subject outside of the camera's focus frame.

1 Aim the lens at the subject so that the subject appears in the focus frame and press the shutter release button halfway down.

The subject is focused, the in-focus indicator sounds and "O" on the LCD monitor and the standby LED (green) beside the finder light to indicate that focusing is locked.

- In addition to focus, the exposure is also locked (AE lock).

2 Keep the shutter release button halfway depressed, recompose the picture and fully depress the shutter release button.

- The focus lock is released when you take your finger off the shutter release button.

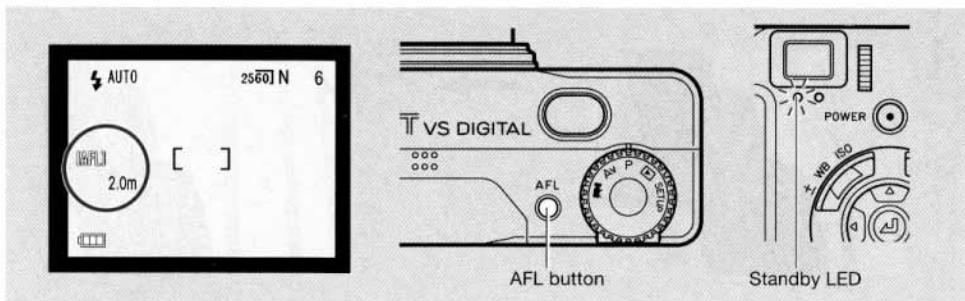

<Locking focus using the AFL button>

Focus can also be locked by pressing the AFL button. This allows you to concentrate on the task at hand: pressing the shutter release button to take the picture.

1 Aim the lens at the subject so that the subject appears in the focus frame and press the AFL button until the standby LED lights.

Focus is locked when the standby LED lights. You can now take your finger off the AFL button. The LCD monitor displays [AFL] and the distance.

- The subject is not in focus when the standby LED (Green) flashes.
- Focus lock is canceled by pressing the AFL button a second time.
- The focus lock is canceled when the photography mode is changed (P, Av ↔ ) or the "MF" button is pressed.

2 Recompose the picture and fully depress the shutter release button.

- The focus lock is canceled when the photo is taken.
- You can set up the camera so that it stays in focus lock mode until the camera is turned off. (P86)
- In addition to focus, the exposure is also locked. (P86)

<Subjects that are difficult or impossible for the auto focus function to handle>

Since the following subjects are difficult to focus, focus on a different subject located at the same distance, use the focus lock and recompose the picture.

- Low contrast subjects
- Subjects with repeating patterns
- Dark subjects
- Subjects consisting of only the horizon or horizontal lines
- Extremely bright or glossy subjects
- When there is a strong light source in the focus frame or its vicinity, or there is sunlight or other strong light source on the screen.
- When there are two or more subjects at extremely different distances within the focus frame.
- Subjects moving at high speed.

2. Macro Photography



Use the macro mode to capture subjects that are at a distance (*) of 0.6 to 0.15 m. Use auto focus to focus the subject. (*Distance from the CCD)

- Set the zoom position to wide-angle in the macro mode.

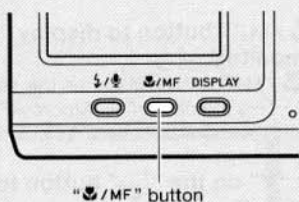

2



1 Set the mode dial to “P” or “Av” and turn on the camera.

2 Press the “ / MF” button to display “” on the LCD monitor.

This completes all the settings.

Each press of the “ / MF” button changes the settings as follows: normal AF “No indication” → Macro AF “” → Manual Focus “MF” (and back).

- The flash mode is set to “” (Flash-off).
- The macro setting is canceled when the camera is turned off.

3 Approach the subject, compose the picture in the LCD monitor and press the shutter release button halfway down.

When the subject is in focus, the in-focus indicator “○” lights.

- The standby LED (Green) lights to indicate that the subject is in focus.

4

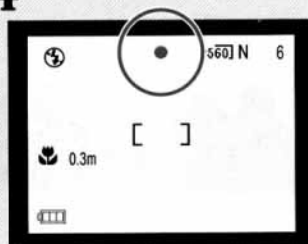

4 Check that “○” is lit and take the picture.

- Use the LCD monitor for taking photographs in the macro mode. The optical viewfinder shows an image that differs widely from the image that you actually capture.
- The flash can be fired with the “ / MF” button in the macro mode. However, since the subject is too close to be within adjustable range, use flash exposure compensation and make test shots to find the right exposure.
- The shooting area when closest to the subject is about 76 mm x 102 mm. (Shooting distance: 0.15 m)

3. Manual Focus Photography

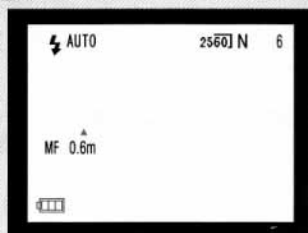

Focus can be set manually. If you take subjects at the same distance, you only have to adjust the focus once after which all you have to do is set an aperture and shoot.

2



1 Set the mode dial to “P” or “Av” and turn on the camera.

2 Press the “ / MF” button to display “MF” on the LCD monitor.

Each press of the “ / MF” button changes the settings as follows: normal AF “No indication” → Macro AF “” → Manual Focus “MF” (and back).

3 Press “▲” or “▼” on the “” button to set the desired shooting distance.

You can continue taking pictures at the same distance when the camera is turned on after making this setting.

3

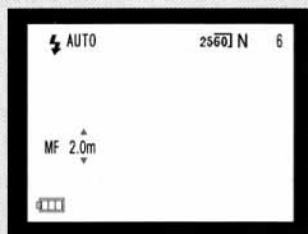

<The settable range (unit: m)>

0.6, 0.7, 0.8, 1, 1.5, 2, 5, ∞

- The standby LED (Green) is on during manual focusing.
- The manual focus distance is retained until canceled. (P86)

4 Compose the picture and shoot.

4. Exposure Compensation

When there is marked difference in brightness between the main subject and the background, the main subject will not be correctly exposed. Exposure compensation is required in this type of situation. It can also be used to intentionally over- or underexpose an image.

Exposure compensation can be set in 1/3 EV increments between +2 EV to -2EV.

2

Set exposure compensation is indicated.

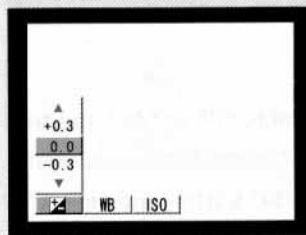

1 In the "P" or "Av" exposure mode, press the \pm WB ISO button to display a menu.

2 Use " \leftarrow " or " \rightarrow " on the " \odot " button to select " \pm " (exposure compensation) in the menu.

3 Use " \blacktriangle " or " \blacktriangledown " on the " \odot " button to select the "value to be compensated" and press the \pm WB ISO button.

The camera returns to the exposure screen and indicates the compensation value. This completes all the settings and you are ready to take the picture.

- If you decide not to take the shot after setting compensation, return the setting to "0.0" as described in steps 1 and 2.
- You can change the time period that the exposure compensation setting remains valid. (P88)
- You can set compensation in increments of 0.5 EV. (P88)

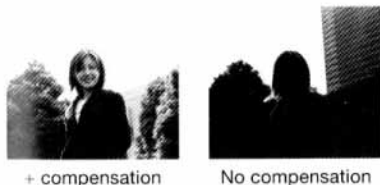

+ compensation

No compensation

Backlit subjects

Set a compensation value between "+0.3 EV and "+2EV. Subjects that are backlit or shot against the sky or sea, subjects near a window or similar situations when a strongly lit background occupies the major part of the frame tend to be underexposed and are often rendered as a silhouette. Use a compensation value between +0.3 EV and +2 EV to increase exposure.



- compensation

No compensation

Dark backgrounds

Set a compensation value in the range "-0.3 EV to "-2EV. A strongly lit subject against a dominating dark background, such as a person in a spot light, becomes overexposed and gets a "washed out" look. Use a compensation value between -0.3 EV to -2 EV to decrease exposure.

You can use the histogram function to check the distribution of brightness to adjust exposure. Press the DISPLAY button to display the histogram and press the \pm WB ISO button to select exposure compensation. For details on using the histogram feature, refer to P32.



5. White Balance Adjustment

Unlike the human eye that automatically adjusts for differences in ambient light, the CCD in a camera must be adjusted for the colors of the light source to render white as white. Thus sunlight, interior incandescent lighting, interior fluorescent lighting, etc. all require different white balance settings. Set white balance as dictated by the light source.

White balance types

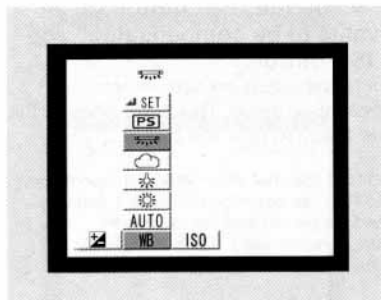
[AUTO]	Automatically set the white balance according to the light source.
[☀]	Bright outdoor daylight
[☀☁]	Interior incandescent lighting
[☁]	Cloudy outdoor lighting
[☀⚡]	Interior fluorescent lighting
[PS]	Manually set white balance
[▲ SET]	Set manually using a white object



- 1 Set the mode dial to “P” or “Av” and turn on the camera.
- 2 Press the \pm WB ISO button and select “WB” using “◀” or “▶” on the “” button.
- 3 Use “▲” or “▼” on the “” button to select the desired item and press the \pm WB ISO button.

The camera returns to the exposure screen and indicates the white balance value. This completes all the settings.

- “AUTO” is not displayed on the LCD monitor.

<To manually set the white balance>

In a scene with many different light sources, use the following procedure to make an accurate white balance setting.

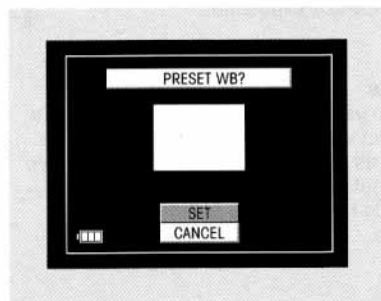

- 1 Press the \pm WB ISO button and select “WB” using “◀” or “▶” on the “” button.
- 2 Press the “▲” button to select “▲ SET” and press the “▲” button.
The [PRESET WB?] screen appears.
- 3 Bring the camera close enough to a white card or similar object you want to use as a reference for white so that it fills the entire screen then select [SET] and press the “▲” button. (The camera returns to the screen shown in step 2.)

- [PS] indicates a manually set white balance.

- 4 Press the \pm WB ISO button to return to the exposure screen and complete the setting.

- This manual white balance setting is stored and used for subsequent shooting. Change the setting when the light source changes.

6. ISO Setting

"ISO" corresponds to the ISO number used for expressing the sensitivity of a film to light. Lower ISO values indicate lower sensitivity to light. Higher ISO values indicate greater sensitivity to light and are appropriate when shooting in darker situations or with higher shutter speeds. However, higher ISO values make images more susceptible to visual noise so select a low ISO value when you wish to reduce noise.

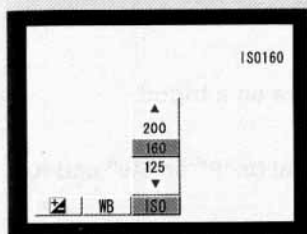

The settable ISO value:

AUTO, ISO 80, 100, 125, 160, 200, 250, 320, 400

- 1** Set the mode dial to "P" or "Av" and turn on the camera.
- 2** Press the \pm WB ISO button and select "ISO" using " \leftarrow " or " \rightarrow " on the " \odot " button.
- 3** Use " \blacktriangle " or " \blacktriangledown " on the " \odot " button to select the desired ISO value and press the \pm WB ISO button.

The camera returns to the exposure screen and indicates the ISO value. This completes all the settings.

- "AUTO" is not displayed on the LCD monitor.
- "AUTO" sets the camera to an ISO value that suits the lighting conditions of the subject.

7. "C MENU" Photography

① Self-Timer/Remote Control Photography

Use self-timer/remote control photography to perform the following types of photography.

- [10S]: Use this mode to include yourself in the photograph. (It can also be used with a remote control.)
- [2S]: Use this mode when taking close-ups and making copies to prevent camera shake. (It can also be used with a remote control.)
- [0S]: Use this mode to release the shutter remotely. (remote photography)
- [OFF]: Use this mode to cancel self-timer/remote control photography to enable use of the shutter release button.

4

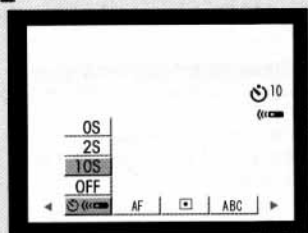

5

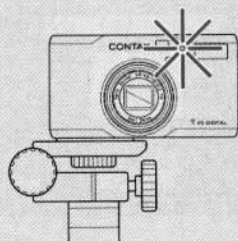
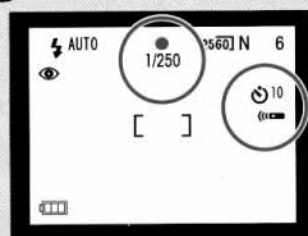

1 Place the camera on a tripod.

2 Set the mode dial to "P" or "Av" and turn on the camera.

3 Press the "C MENU" button and use "◀" or "▶" on the "DISP" button to select "⌚".

4 Use "▲" or "▼" on the "DISP" button to select "10S" or "2S" and press the "C MENU" button.

The camera returns to the exposure screen and displays the Self-timer. This completes all the settings.

5 Press the shutter release button halfway down, check that "○" on the LCD monitor lights before pressing the shutter release button fully.

The self-timer number on the LCD monitor starts to count down.

6 The self-timer is activated and the shutter is released after 10 seconds or 2 seconds.

- The self-timer setting is canceled when the camera is turned off.
- To cancel the self-timer after it has been activated, turn off the camera.
- The self-timer LED flashes during self-timer operation.
- The aperture and focus are locked once the self-timer starts operating.
- If the shutter release button is pressed during self-timer operation, the self-timer stops.
- The self-timer cannot be started when the flash is charging.

Transmission range

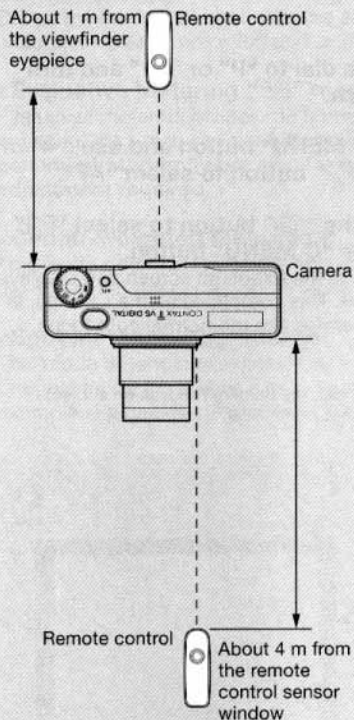

Remote control operation

You can use a remote control for "10S", "2S" and "0S". When "0S" is selected, the shutter is released immediately.

<Example of remote control photography>

Use the instructions on the previous page to set "10S".

1 Aim the camera at the subject, press the AFL button to lock focus.

- It is a feature of this camera that the shutter can be released even if the subject is not in focus so be sure to lock the focus with the AFL button.

2 Compose the picture.

3 Aim the sender window on the remote control at the remote control receiving window on the camera and press the send button.

The self-timer LED starts flashing and releases the shutter in 10 seconds.

- In rare instances, it may not be possible to use the remote control in backlighting or under inverter type fluorescent lighting.
- The shutter can be released on the camera back panel. The standby LED (green) beside the finder blinks twice when the camera receives the signal from the remote control.

② Spot Auto Focus Photography

The wide focus frame indicated by the wide "[]" brackets is the default auto focus setting. Select the spot focus frame indicated by the narrow "[]" brackets, to focus on a specific subject.

2

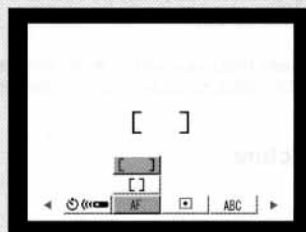

1 Set the mode dial to "P" or "Av" and turn on the camera.

2 Press the "C MENU" button and use "◀" or "▶" on the "⊙" button to select "AF".

3 Use "▼" on the "⊙" button to select "[]" and press the "C MENU" button.

The camera returns to the exposure screen and displays the spot focus frame. This completes all the settings. In other respects it operates like the normal auto focus mode.

- In the optical viewfinder, the camera focuses on subjects inside the focus frame.

3

Spot focus frame

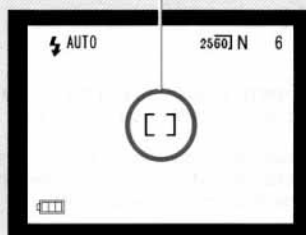

③ Metering Mode Selection

This camera is equipped with three metering modes: evaluative metering, center-weighted metering and spot metering.

Select the mode that best suits the ambient conditions and the image you have in mind to produce pictures of greater precision and artistic power.

<Evaluative Metering ("☰" mark)>

Evaluative metering divides the frame into segments and determines optimum exposure on data obtained from each segment. **Because of this, evaluative metering can be used not only for general photography but also for backlit subjects with virtually no exposure compensation or adjustment required.**

<Center-weighted Metering ("□" mark)>

This mode determines correct exposure by measuring the light with emphasis on the brightness of the subject at the center of the viewfinder, **which makes it ideal for general photography.**

<Spot Metering ("◻" mark)>

This mode determines exposure on brightness at the center of the frame.

Use this mode for scenes where the brightness of the subject and the background differ greatly. An example is a backlit subject or a person standing in a spot light on a stage.

2

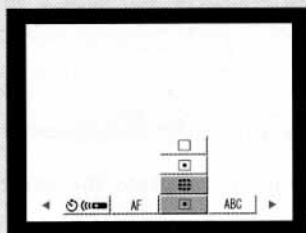

1 Set the mode dial to "P" or "Av" and turn on the camera.

2 Press the "C MENU" button and use "◀" or "▶" on the "◂" button to select "☰".

3 Use "▲" or "▼" on the "◂" button to select the desired metering mark and press the "C MENU" button.

The camera returns to the exposure screen and displays the selected metering mark. This completes all the settings.

- The measurement results are not displayed on the LCD monitor.

3

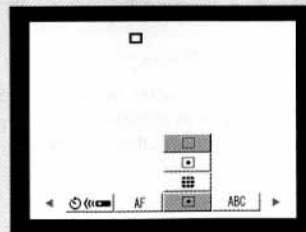

④ Taking Pictures with the Exposure Auto Bracketing Control Mode (ABC mode)

The ABC mode can be used to automatically take a series of three pictures with three exposures: standard, overexposed and underexposed.

Use this when shooting under difficult lighting conditions to ensure correct exposure.

* ABC: Automatic Bracketing Control

The ABC mode performs automatic exposure compensation by controlling the shutter speed.

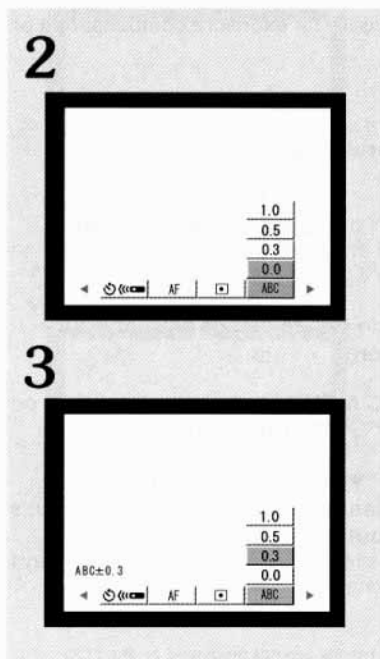

1 Set the mode dial to “P” or “Av” and turn on the camera.

2 Press the “C MENU” button and use “◀” or “▶” on the “” button to select “ABC”.

3 Use “▲” or “▼” on the “” button to select a compensation range and press the “C MENU” button.

The camera returns to the exposure screen and displays the compensation range. This completes all the settings.

The compensation range can be set to: ±0.3 EV, ±0.5 EV and ±1 EV.

- The flash mode is set to “” (Flash-off).
- It is not possible to use ABC mode together with flash.
- When exposure compensation is used, that value is used as the reference compensation value in the ABC mode.
- In drive mode “S”, the camera measures the exposure value for each shot. In drive mode “C”, exposure compensation is based on the exposure measured for the first shot.
- The ABC mode is canceled when the camera is turned off.

4 Focus on the subject and press the shutter release button.

In the ABC mode, the following indications are made on the LCD monitor.

Standard:	ABC ±0.3 [0]	flashing 0
Over:	ABC ±0.3 [+]	flashing +
Under:	ABC ±0.3 [-]	flashing -

In drive mode “S”, each time the shutter release button is pressed, frames are taken with the following exposures based on the set compensation range: standard, over and under.

When the shutter release button is pressed in drive mode "C", three frames are taken in standard exposure, overexposure and underexposure.

- The focus set for the first photo is used for all three photos.
- If the set compensation range exceeds the camera's exposure limits, the photos are taken at maximum possible compensation values.
- You can change the exposure order to over → standard → under. (P88)
- Shooting cannot be performed when there are less than three frames left (in drive mode "C").

⑤ Continuous Shooting "C"

The continuous shooting mode allows you to shoot a sequence of pictures as long as the shutter release button is depressed.

2

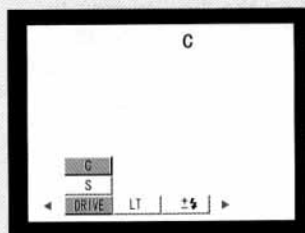

3

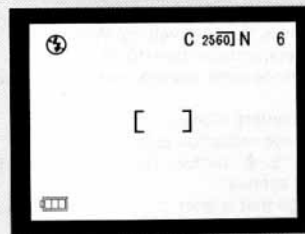

1 Set the mode dial to "P" or "Av" and turn on the camera.

2 Press the "C MENU" button and use "◀" or "▶" on the "DISP" button to select "DRIVE".

3 Use "▲" on the "DISP" button to select "C" and press the "C MENU" button.

The camera returns to the exposure screen and shows the C icon. This completes all the settings.

- The flash mode is set to "⊕" (Flash-off).

4 Focus on the subject and fully depress the shutter release button.

Exposures are made as long as the shutter release button is depressed.

- Continuous shooting is performed at a rate of 2 frames per second for the first three frames. Subsequent frames are shot at a speed that is determined by the time it takes to find free space in the memory.

- When "⚡" fill-in flash mode is selected, continuous shooting is performed with intervals to enable the flash to charge.
- The remote control cannot be used during continuous shooting.

⑥ “LT” Longtime Exposure

Long exposures from 1 to 8 seconds can be made, which is convenient for taking photos of fireworks or the night sky.

The following time settings are available: 1 sec, 2 sec, 4 sec, 8 sec.

2

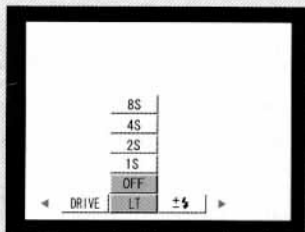

3

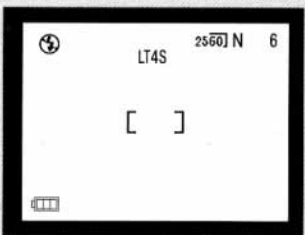
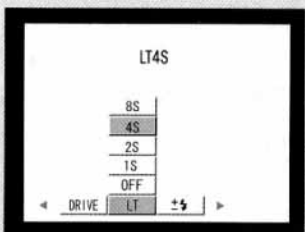

1 Set the mode dial to “P” or “Av” and turn on the camera.



2 Press the “C MENU” button and use “◀” or “▶” on the “” button to select “LT” (Longtime).

3 Use “▲” or “▼” on the “” button to select desired “TIME” and press the “C MENU” button.

The camera returns to the exposure screen and displays the longtime setting. This completes all the settings.

- The flash mode is set to “” (Flash-off).

4 Take the picture.

- Automatic exposure is not performed in this mode.
- Set the aperture manually in the “Av” setting. When set to “P”, the lens is set to maximum aperture (F2.8).
- To cancel the longtime mode once started, use steps 2 and 3 to set it to “OFF”.
- Use a tripod to prevent camera shake.
- You can turn on the red-eye reduction auto flash mode “ AUTO” by pressing the “” button. This is convenient for shooting people in night scenes.
- Noise may enter an image that is shot using a long exposure time.
- Exposure compensation and ABC exposure cannot be set during long time exposure.

⑦ Flash Exposure Compensation

Flash exposure compensation allows you to modify flash output. (± 1 EV)

3

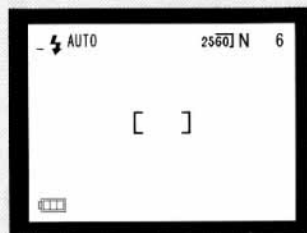
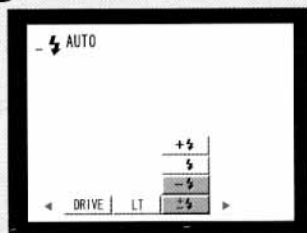



1 Set the mode dial to "P" or "Av" and turn on the camera.

2 Press the "C MENU" button and use "◀" or "▶" on the  button to select "+1/2".

3 Use "▲" or "▼" on the  button to select the desired setting and press the "C MENU" button.

The camera returns to the exposure screen and displays the flash exposure compensation icon. This completes all the settings.

	+ Compensation (+1 EV)
	Normal
	- Compensation (-1 EV)

4 Take the picture.

- Flash exposure compensation is retained even after the camera is turned off.

8. "D MENU" Photography

① Changing Image COLOR

The default setting is COLOR, but the camera can be set up to produce sepia or black and white images.

2

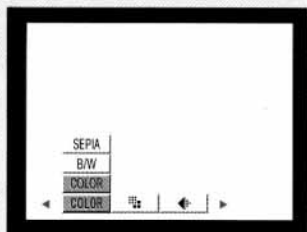

3

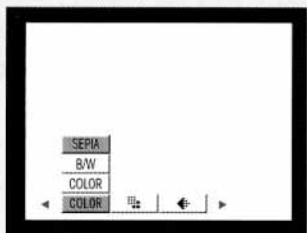

1 Set the mode dial to "P" or "Av" and turn on the camera.

2 Press the "D MENU" button and use "◀" or "▶" on the "DISP" button to select "COLOR".

3 Use "▲" or "▼" on the "DISP" button to select "B/W" or "SEPIA" and press the "D MENU" button.

The setup is completed when the LCD screen turns sepia or black and white.

- When "B/W" or "SEPIA" is selected, WB, WB/BKT and chroma adjustment cannot be set.

② PIXELS and QUALITY

Pixels are the dots that make up an image.

More dots produce images with a higher resolution but the resulting image files are larger, meaning that fewer files can be stored on the memory card.

Quality is the compression ratio used when digitizing captured image data.

"FINE" uses a low compression ratio to minimize corruption of image details. "NORMAL" uses a higher compression ratio which produces lower quality images but means that more images can be stored on a memory card.

Number of images that can be recorded on a 16 MB memory card

PIXELS	QUALITY	
	"F" FINE	"N" NORMAL
"2560" 2560 × 1920	Approx. 4 – 6	Approx. 8 – 12
"1600" 1600 × 1200	Approx. 10 – 15	Approx. 20 – 29
"1280" 1280 × 960	Approx. 16 – 23	Approx. 30 – 43
"640" 640 × 480	Approx. 54 – 73	Approx. 88 – 112

3

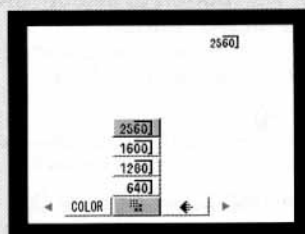

4

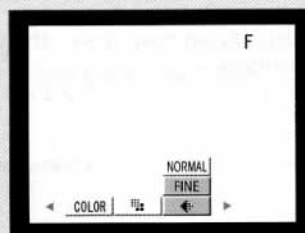

1 Set the mode dial to "P" or "Av" and turn on the camera.

2 Press the "D MENU" button and use "◀" or "▶" on the  button to select "⊞" (PIXELS).

3 Use "▲" or "▼" on the  button to select the desired PIXELS.

4 Use "◀" or "▶" on the  button to select "⚡" (QUALITY).

5 Use "▲" or "▼" on the  button to select the desired QUALITY.

6 Press the "D MENU" button.

The camera returns to the exposure screen and displays the PIXELS and QUALITY icons. This completes all the settings.

③ Taking Pictures with the White Balance Shifted in Three Steps (WB/BKT Exposure)

The "WB/BKT" exposure mode allows you to automatically take a series of three photographs using three different types of white balance: standard, over (with a slightly blue cast) and under (with a slightly red cast).

Use this when shooting under difficult light sources to ensure correct exposure.

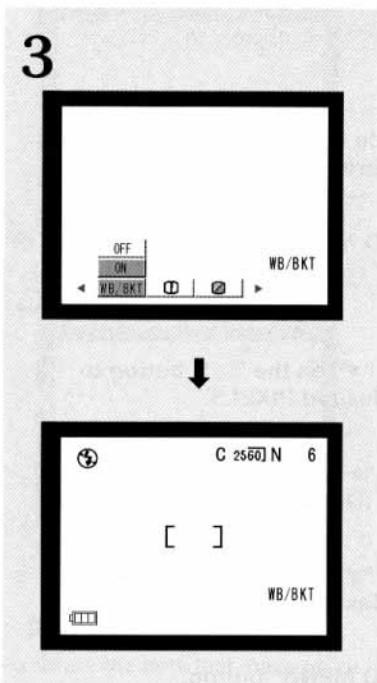

1 Set the mode dial to "P" or "Av" and turn on the camera.

2 Press the "D MENU" button and use "◀" or "▶" on the  button to select "WB/BKT".

3 Use "▼" on the  button to select "ON" and press the "D MENU" button.

The camera returns to the exposure screen and shows the WB/BKT icon. This completes all the settings.

- The flash mode is set to  (Flash-off).
- WB/BKT exposure is based on the set white balance value.
- The WB/BKT exposure is canceled when the camera is turned off.
- It is not possible to use WB/BKT exposure together with flash.
- When WB/BKT is set to "ON", the color mode "B/W" or "SEPIA" cannot be set.
- WB/BKT cannot be set in the "B/W" or "SEPIA" color mode.

4 Focus on the subject and hold down the shutter release button.

Three frames are taken in succession when the shutter release button is pressed.

- Shooting cannot be performed when there are less than three frames left.

④ Setting SHARPNESS

This feature adjusts the outlines of the subject.

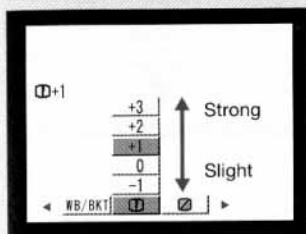

1 Set the mode dial to "P" or "Av" and turn on the camera.

2 Press the "D MENU" button and use "◀" or "▶" on the "D MENU" button to select "D".

3 Use "▲" or "▼" on the "D MENU" button to select the desired value and press the "D MENU" button.

The camera returns to the exposure screen, which shows the "D" icon and the selected value. This completes all the settings.

- This setting is retained even after the camera is turned off.

⑤ Adjusting CHROMA

CHROMA adjusts color intensity.

- [+] Heightens color intensity.
- [0] STANDARD
- [-] Reduces color intensity.

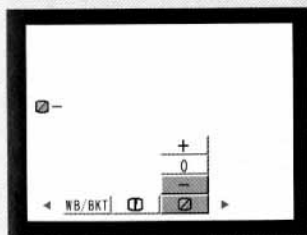

1 Set the mode dial to "P" or "Av" and turn on the camera.

2 Press the "D MENU" button and use "◀" or "▶" on the "D MENU" button to select "D".

3 Use "▲" or "▼" on the "D MENU" button to select the desired item and press the "D MENU" button.

The camera returns to the exposure screen and shows the "D" icon and the selected value. This completes all the settings.

- This setting is retained even after the camera is turned off.



Photography

Movie Recording

1. Recording Movies

This camera is provided with a movie function. You can make a 30 second recording at a resolution of 240 x 320 or a 120 second recording at a resolution of 120 x 160.

- 1** Counter display
Before shooting: total time that can be recorded
During shooting: remaining time that can be recorded (count-down display)

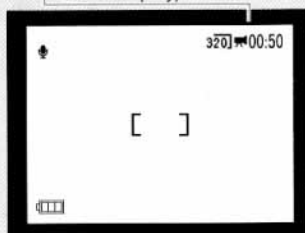

- 3** In-focus indicator (green)
Remaining time

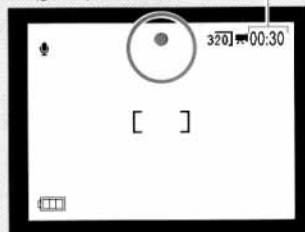

- 4** In-focus indicator (red): during shooting
Remaining time

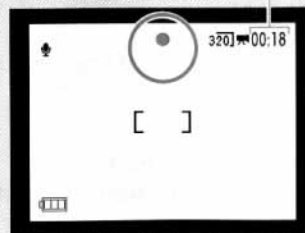

Display panel

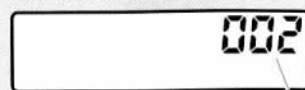

Remaining movie counter

- 1** Set the mode dial to "M" and press the **POWER** button to turn on the camera.

- The flash cannot be used during movie recording.

- 2** Look at the LCD monitor to compose the movie.

You can use the zoom button to enlarge the image on the monitor.

- 3** Aim the focus frame at the subject and depress the shutter release button halfway.

When the subject is in focus, the in-focus indicator "O" lights.

- The focus is locked during shooting.

- 4** Confirm that the in-focus indicator "O" lights before you fully depress the shutter release button.

The in-focus indicator "O" changes from green to red indicating that shooting has started. The recording time is also indicated.

- The zoom button cannot be used during shooting with sound recording. But it can be used for movies without sound (P62).

- 5** Depress the shutter release button halfway to end the shooting session.

- The shooting session ends automatically when the allowable shooting time is exceeded.

- The display panel shows the total number of movies that can be recorded (during the 30 or 120 second recording time). The remaining movie counter indicates "000" when remaining recording time is less than maximum recording time.

2. Functions for Enhancing Movie Recording

The following functions are available during a movie recording. Use them as required by the recording.

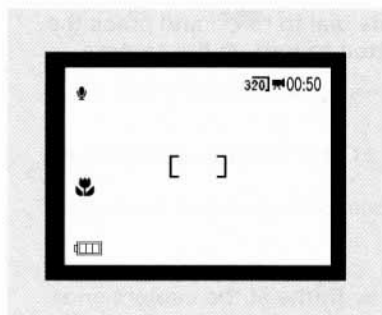

① Focusing

You can select auto focus (AF), macro auto focus (🌸) or manual focus (MF).

Press the “🌸 / MF” button to select the desired focusing mode.

Each press of the button changes the display as follows: “No display” (AF) → “🌸” (macro AF) → “MF” (manual focus) → “No display” (AF) (and back).

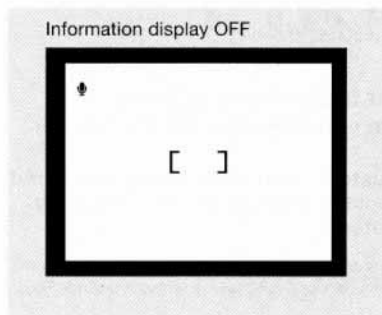

② LCD Monitor Display

You can select information display ON/OFF and monitor OFF.

Press the DISPLAY button to select the desired mode.

Each press of the button changes the display as follows: “Information display ON” → “Information display OFF” → “Monitor OFF” → “Information display ON” (and back).

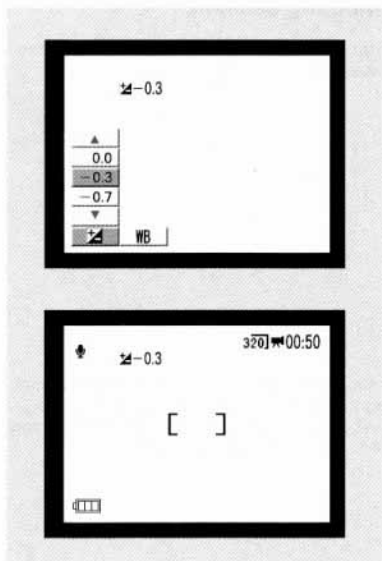

③ Exposure Compensation

The camera provides the same type of exposure compensation for movies as for still photography. (P43)

1 Press the ± WB ISO button and use “◀” or “▶” on the “🌸” button to select “±”.

2 Use “▲” or “▼” on the “🌸” button to select the desired compensation value and press the ± WB ISO button.

The camera returns to the exposure screen and indicates the compensation value. This completes all the settings.

④ Setting White Balance

The camera provides the same type of white balance for movies as for still photography. (For details on settings and presets, refer to P44.)

1 Press the \pm WB ISO button and select “WB” using “ \blacktriangleleft ” or “ \blacktriangleright ” on the “ \odot ” button.

2 Use “ \blacktriangle ” or “ \blacktriangledown ” on the “ \odot ” button to select the desired item and press the \pm WB ISO button.

The camera returns to the exposure screen and indicates the white balance setting. This completes all the settings.

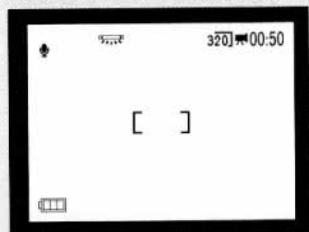
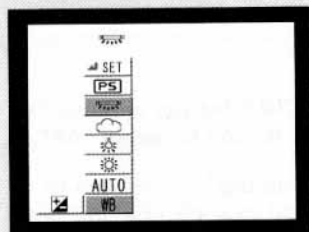

⑤ Self-timer and Remote Control Recording

The camera provides the same type of self-timer and remote control operation for movies as for still photography. (For details on settings, refer to P46.)

1 Press the “C MENU” button and use “ \blacktriangleleft ” or “ \blacktriangleright ” on the “ \odot ” button to select “ \odot ”.

2 Use “ \blacktriangle ” or “ \blacktriangledown ” on the “ \odot ” button to select the desired setting and press the “C MENU” button.

The camera returns to the exposure screen and indicates the setting. This completes all the settings.

- You can use the remote control to start a movie. To stop the movie, press the same button again.
- The remote control cannot be used to cancel the self-timer once it has started.

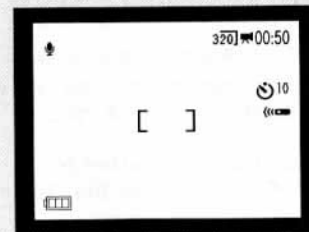
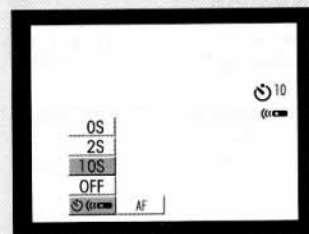

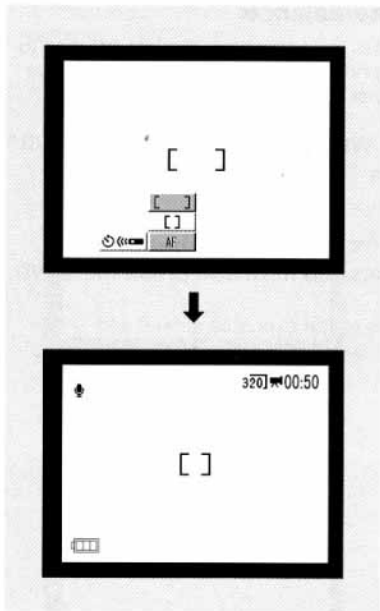

⑥ Setting Focus Area

The camera provides the same type of focusing for movies as for still photography. (For details on settings, refer to P48.)

- 1 Press the “C MENU” button and use “◀” or “▶” on the “” button to select “AF”.
- 2 Use “▲” or “▼” on the “” button to select the desired focus frame and press the “C MENU” button.

The camera returns to the exposure screen and shows the selected focus frame. This completes all the settings.

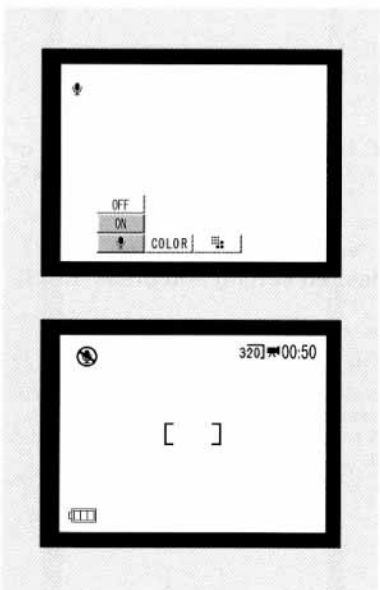

⑦ With Sound/No Sound

The camera allows you to select movie recording with or without sound.

- “ON” (With sound): adds sound to the movie, but you cannot zoom.
- “OFF” (No sound): does not add sound to the movie, but you can zoom.

- This camera does not allow the use of the zoom when recording a movie with sound to prevent zoom noise from interfering with movie-making.
- You cannot add sound to a movie afterwards (using “RECORDING”).

- 1 Press the “D MENU” button and use “◀” or “▶” on the “” button to select “”.
- 2 Use “▲” or “▼” on the “” button to select “ON” or “OFF” and press the “D MENU” button.

The camera returns to the exposure screen and shows “” (with sound) or “” (no sound). This completes all the settings.

⑧ Changing COLOR

Like for still photography, you can select color, B/W (black-and-white) and SEPIA.

1 Press the “D MENU” button and use “◀” or “▶” on the “” button to select “COLOR”.

2 Use “▲” or “▼” on the “” button to select “B/W” or “SEPIA” and press the “D MENU” button.

The setup is completed when the LCD screen changes to sepia or black and white.



- When “B/W” or “SEPIA” is selected, WB adjustment cannot be made.

⑨ Resizing

You can select one of two resolutions when making movies.

320] “240 x 320” (default setting) or **160**] “120 x 160”

- This mode setting survives a power off and remains valid until changed.

1 Press the “D MENU” button and use “◀” or “▶” on the “” button to select “”.

2 Use “▲” or “▼” on the “” button to select “**160**” or “**320**” and press the “D MENU” button.

The camera returns to the exposure screen and indicates the set resolution. This completes all the settings.

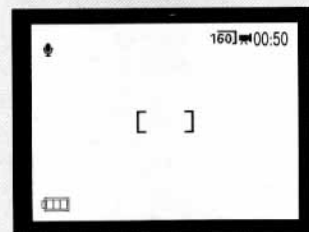
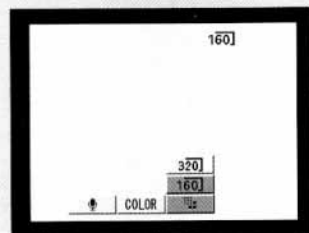
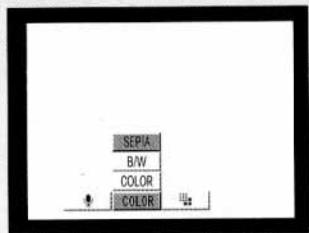

Playing and Erasing

Playback menu functions (○: usable, ×: cannot be used)

	MULTI Display/ SINGLE Display	RECORDING	PROTECT	ERASE	ERASE ALL	RESIZE	ROTATE	AUTO PLAY	PRINT
Still photography	○	○	○	○	○	○	○	○	○
Movie	○	×	○	○	○	×	×	○	×

Playing and Erasing Still Images

1. Displaying Images on the LCD Monitor

1

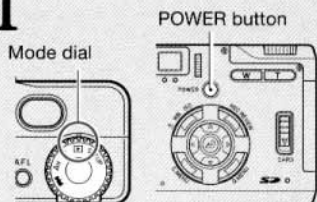

- 1 Set the mode dial to “” and turn on the camera.



2





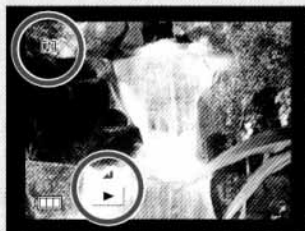

Still image without sound



Still image with sound



- 2 The last image shot appears on the LCD monitor. Press the “” button on the “” button to display the images in the order they were taken and use the “” button to view them in reverse order.

- The “” and “” icons appear when a still image with sound is played back. Press “” on the “” button to play back the sound. Use the “” or “” button to adjust the playback volume. (P71)

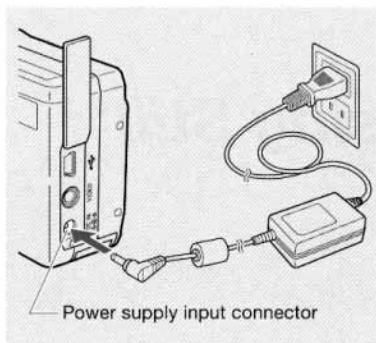

Connect the camera to the AC adapter for long shooting sessions.

- Check that a memory card is inserted.

2. Close-up Image Playback (2x, 4x)

Playback images can be enlarged to twice or four times their original size.

1 Display the image you want to enlarge.

2 Press the "T" (telephoto) zoom button.

Press the "T" zoom button once to double the center of the image and press it once more to enlarge it four times. "X2" or "X4" is indicated in the upper right corner of the screen.

3 Use "▲", "▼", "◀" or "▶" on the "⊕" button to select the area you want to display.

- To return to the original image size, press the "W" (wide) zoom button.

1



2



3



3. Displaying Exposure Information (Information Display)

The exposure information of an image such as exposure, shutter speed, exposure compensation, etc. can be displayed in an information display.

1 Select and display the image whose information you want to see.

2 Press “▲” or “▼” on the “” button.

The image and the exposure information is displayed.

3 Press “▲” or “▼” to return to the previous screen.

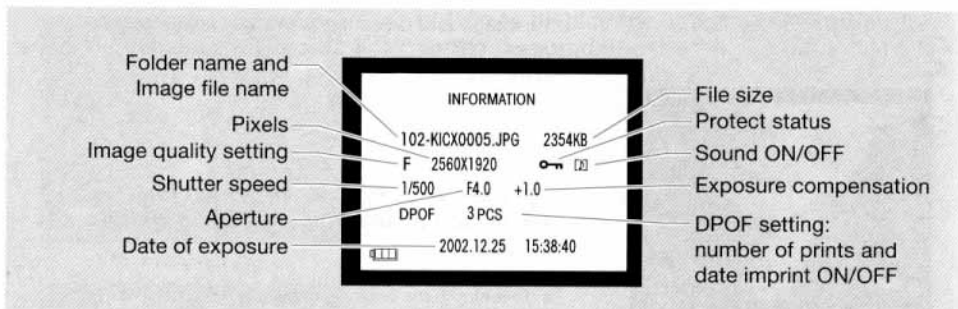

4. Displaying Histogram (Brightness Distribution Graph)

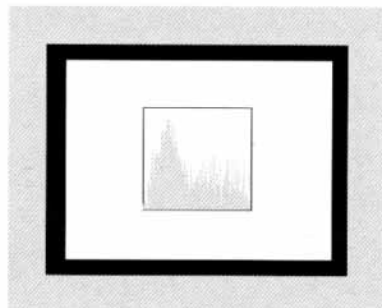

Histograms show the distribution of brightness in an image. You can use this as reference in processing over- or under-exposed images or other operations when using image processing software. (Still photography only)

1 Select and display the image whose histogram you want to see.

2 Press the **DISPLAY** button to view a histogram.

- To return to the original screen, press the **DISPLAY** button again.

A histogram is a graph showing the distribution of brightness in a recorded image. The higher the histogram is towards the left side the darker the image is, while the higher it is towards the right side the brighter it is. (The horizontal axis shows pixel brightness, while the vertical axis shows the number of pixels of each brightness.)

5. Multiple Image Playback (Index Display)

2

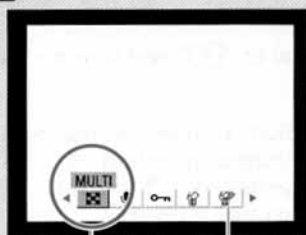

Multiple image display

Menu display

3

Multiple image screen

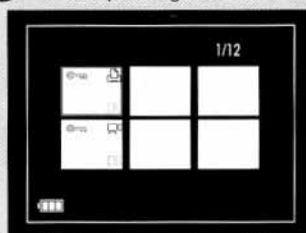

Multiple image playback allows you to display six images on the LCD monitor at the same time. This is helpful in making selections when there are a great many images on the memory card. This feature can be used together with other playback menu functions.

1 Set the mode dial to "▶" and turn on the camera.

2 Press the "D MENU" button and use "◀" or "▶" on the "D MENU" button to select "MULTI" and press "▶" button.

The multiple playback screen appears on the LCD monitor.

The icons in the image indicate the following:

- Protected image: "🔑"
- Image with sound: "[]"
- Movie: "🎬"
- DPOF setting: "📄"

3 Use "▲", "▼", "◀" or "▶" on the "D MENU" button to select an image.

4 To view the selected image at normal size (SINGLE display), press "▶" on the "D MENU" button.

<Convenient uses>

By pressing the "D MENU" button in multiple image display you can access other functions, such as recording, protect and erase. Use "◀" or "▶" on the "D MENU" button to select a menu.

- No images can be selected while the menu is displayed. To select images, press the "D MENU" button to close the menu.
- Rotate cannot be set in the multiple image display mode.

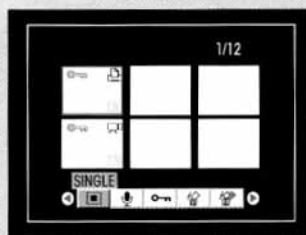

6. [RECORDING] Adding Voice Memos to an Image

2

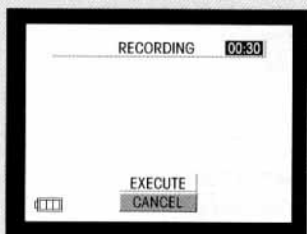

4



5

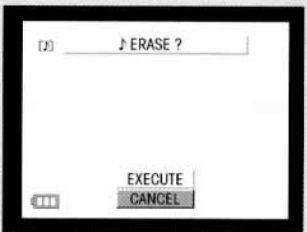

Recording allows you to add sound to a recorded image (still picture) or delete added sound data.

<Adding sound>

1 Set the mode dial to "▶" and turn on the camera.

2 Press the "D MENU" button and use "◀" or "▶" on the "⊙" button to select "RECORDING" and press the "▲" button. [RECORDING] appears on the LCD display.

- The [RECORDING] screen appears when the "⊙" button is pressed even when the "D MENU" button is not pressed.

3 Use "◀" or "▶" on the "⊙" button to select the image you want to add sound to.

- If you do this for an image already with recorded sound, "[]" and [ERASE?] are displayed. Erase the sound of an image you want to make a new sound recording for (see page 71).

4 Use "▲" to select [EXECUTE] and press the "▲" button to start recording. Speak into the microphone to record a message.

The number of seconds left of recording time is indicated on the LCD monitor.

- You can make a recording up to 30 seconds long.

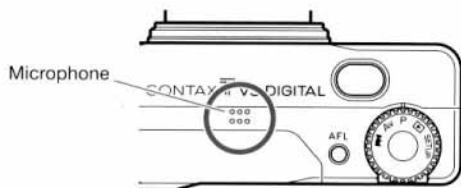

5 Recording stops when the "▲" button is pressed again.

[ERASE?] appears on the LCD monitor.

6 Press the "D MENU" button to return to the normal display (SINGLE display).

- A recording cannot be made in a protected image.

3



4



<Erasing sound>

Use this procedure for erasing the sound of still pictures that contain sound.

Note that sound once erased cannot be restored.

- 1 Set the mode dial to "▶" and turn on the camera.
- 2 Use "◀" or "▶" on the "⊙" button to select the image whose sound recording is to be erased.
[J] is displayed on the LCD monitor for a still image with a sound recording.
- 3 Press the "D MENU" button and use "◀" or "▶" on the "⊙" button to select "⊙" (RECORDING) and press the "▲" button. [JERASE?] appears on the LCD monitor.
- 4 Use "▲" to select [EXECUTE] and press the "▲" button.
- 5 Press the "D MENU" button to return to the normal display (SINGLE display).

The sound is erased and [RECORDING] appears on the display.

- The sound of a protected image cannot be erased.

Sound icon Normal sound playback

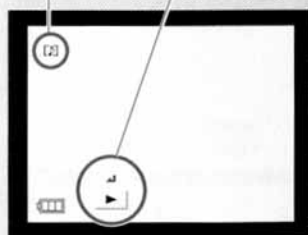

Sound volume adjustment

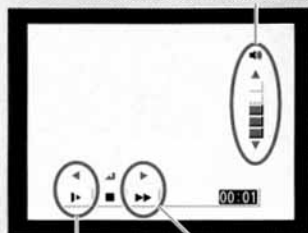

Sound playback at half normal speed

Sound playback at double speed

<Playing back sound>

A still image with sound is indicated as shown in the figure.

Press the "▲" button to start sound playback.

- To stop playback, press the "▲" button again.
- Press "▲" or "▼" button to adjust the sound volume.
- When the "▶" is held down, the sound is played back at double speed. Playback at normal speed resumes when the button is released.
- When the "◀" is held down, the sound is played back at half normal speed. Playback at normal speed resumes when the button is released.

7. [PROTECT] Preventing Accidental Erasure

You can use this function to protect important images from accidental erasure.

This function is particularly convenient for erasing multiple images when used together with the erase all function (P73).

- Note that although protected images remain after using the erase all function, the format function deletes every image on the card.

2

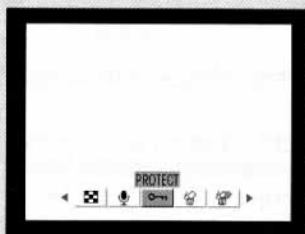

3

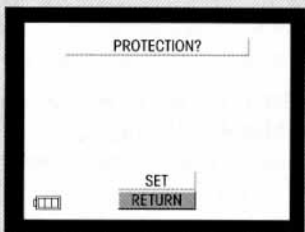

4

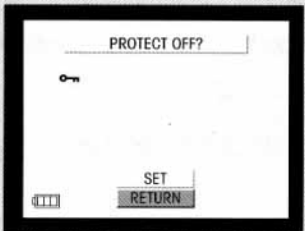

1 Set the mode dial to "▶" and turn on the camera.

2 Press the "D MENU" button and use "◀" or "▶" on the "⊙" button to select "🔑" (PROTECT) and press the "▲" button. [PROTECTION?] appears on the LCD monitor.

3 Use "◀" or "▶" on the "⊙" button to select the image that is to be protected.

4 Use "▲" to select [SET] and press the "▲" button to complete protection. Then the "🔑" icon and [PROTECT OFF?] appears on the LCD monitor.

- To unprotect the image, use "▲" to select [SET] and press the "▲" button. (The "🔑" icon goes out.)

To protect further images, repeat the procedures in steps 3 and 4.

5 Press the "D MENU" button to return to the normal display (SINGLE display).

- To check a protected image after making these settings, display information (P68) or look for the "🔑" icon in multiple playback (P69).

8. Erasing Images

2

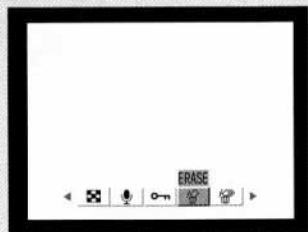

3



<Erasing individual images>

- 1 Set the mode dial to "▶" and turn on the camera.
- 2 Press the "D MENU" button and use "◀" or "▶" on the "DISP" button to select "ERASE" and press the "MENU" button. [ERASE IMAGE?] appears on the LCD monitor.
- 3 Use "◀" or "▶" on the "DISP" button to select the image that is to be erased.
- 4 Use "▲" to select [EXECUTE] and press the "MENU" button.

- When the image has been erased, the next image on the card will be displayed automatically.
- When an image with sound is erased, both the image and the sound are erased.
- Protected images cannot be deleted. To delete protected images, cancel the protection (P72) first.

1

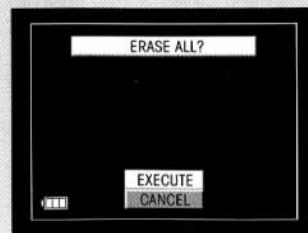

<Erasing All Images>

- 1 Set the mode dial to "▶" and turn on the camera.
- 2 Press the "D MENU" button and use "◀" or "▶" on the "DISP" button to select "ERASE ALL" and press the "MENU" button. [ERASE ALL?] appears on the LCD monitor.
- 3 Use "▲" to select [EXECUTE] and press the "MENU" button.

- When an image with sound is erased, both the image and the sound are erased.
- When all images have been erased, the [NO IMAGE] message is displayed. If a protected image is present, that image is displayed.
- Protected images cannot be deleted. To delete protected images, cancel the protection (P72) first.
- It may not be possible to erase images recorded by other cameras.

9. [RESIZE] Resizing and Trimming

Recorded images can be resized and trimmed. The original image is left intact since resized and trimmed images are saved as new images. (Still photography only)

- Resized images are stored as shown below.

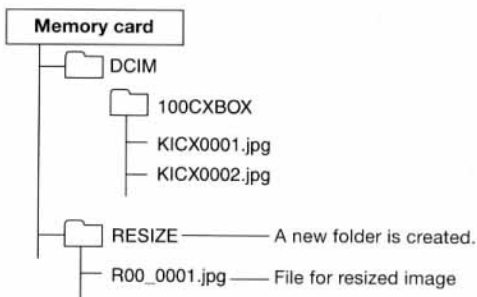

<Resizing>

- 1** Set the mode dial to “” and turn on the camera.
- 2** Press the “D MENU” button and use “◀” or “▶” on the “” button to select “” (RESIZE) and press the “” button.
The [RESIZE MENU] appears.
- 3** Use “▲” or “▼” on the “” button to select [EXECUTE RESIZING] and press the “” button.
The [SELECT RESIZE IMAGE] screen appears.
- 4** Use “◀” or “▶” on the “” button to select the image you want to resize. Then use “▲” to select [OK] and press the “” button.
The [SELECT AREA] screen appears.
- 5** Determine the area to be resized.

The area displayed in the [SELECT AREA] screen is resized.

Use the “T” and “W” buttons to change the zoom ratio (1x, 2x, 4x). Use “▲/▼/◀/▶” on the “” button to select the position and press the “” button.

2



3



4



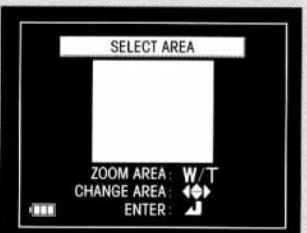

5



6



6 Use “▲” or “▼” on the “” button to select image size and press the “” button.

7



7 A new name for the resized image is displayed. Check the name and press the “” button.

8 Press the “D MENU” button to end the operation.

1

Checking and erasing resized images





<Checking and erasing resized images>

Resized images cannot be viewed using normal playback. Use the following procedure to view resized images.

Perform the first two steps in <Resizing> then follow these steps.

3



1 Use “▲” or “▼” on the “” button to select [RESIZED IMAGE PLAYBACK] and press the “” button.

The resized image is displayed.

2 Use “◀” or “▶” on the “” button to select normal or reverse viewing order.

3 To erase an image, use “▲” on the “” button to select “” and press the “” button.

- Note that no screen for confirming the erase operation is displayed so the image is deleted when the “” button is pressed.

4 Press the “D MENU” button to end the operation.

10. [ROTATE] Rotating Images

2

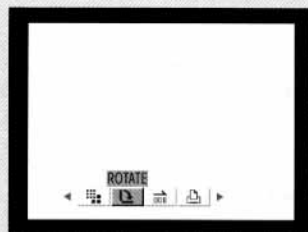

3

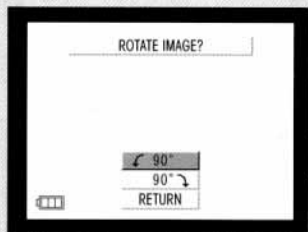

4

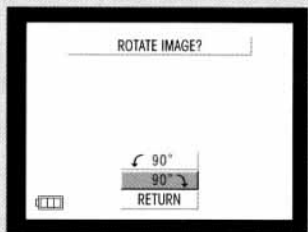

5

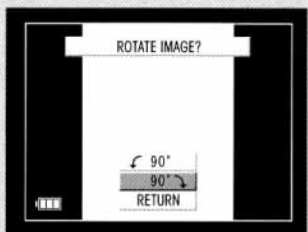



You can rotate images 90° clockwise or counterclockwise. (Still photography only)

1 Set the mode dial to "" and turn on the camera.

2 Press the "D MENU" button and use "◀" or "▶" on the "" button to select "[]" (ROTATE) and press the "" button. [ROTATE IMAGE?] appears on the LCD monitor.

3 Use "◀" or "▶" on the "" button to select the image that is to be rotated.

4 Use "▲" or "▼" on the "" button to select [ 90°] and press the "" button.

[ 90°]: Rotates images 90° counterclockwise.

[90° ]: Rotates images 90° clockwise.

[RETURN]: Cancels the operation and the camera returns to the menu display.

5 The rotated image is displayed.

- To rotate further images, repeat steps 3 and 4.

6 Press the "D MENU" button to end the operation.

- Rotate cannot be set in a protected image.

11. [AUTO PLAY] Playing Back Images Sequentially

2



4

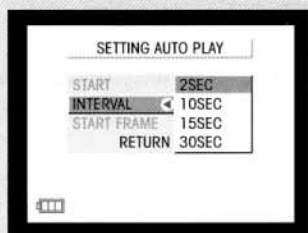

5, 6

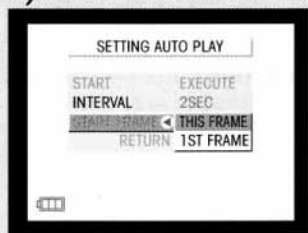

7

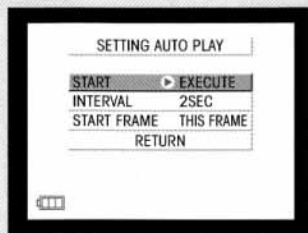

Images can be played back automatically at set intervals.

1 Set the mode dial to "▶" and turn on the camera.

2 Press the "D MENU" button and use "◀" or "▶" on the "MENU" button to select "▶" (AUTO PLAY) and press the "▶" button. [SETTING AUTO PLAY] appears on the LCD monitor.

3 Use "▲" or "▼" on the "MENU" button to select [INTERVAL] and press the "▶" button.

4 Use "▲" or "▼" to select a time interval and press the "▶" button.

5 Use "▲" or "▼" to select [START FRAME] and press the "▶" button.

6 Use "▲" or "▼" to select [THIS FRAME] or [1ST FRAME] and press the "▶" button.

7 Use "▲" or "▼" to select [START] and press the "▶" button to start auto play.

8 To end auto play, press the "▶" button.

12. [PRINT] Using DPOF to Prepare for Printing



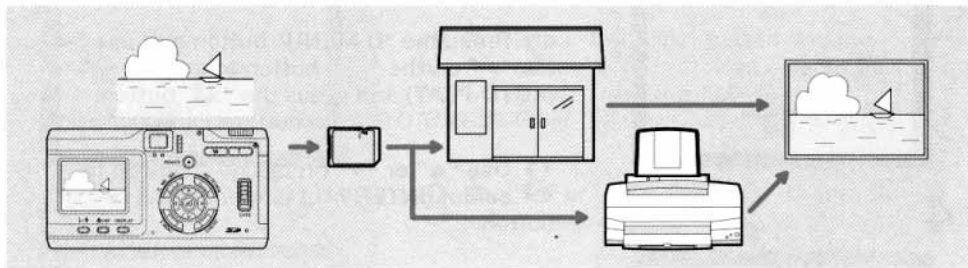

Digital Print Order Format (DPOF) is a standard for printing digital photographs on a home printer or by a commercial printing service. (Still photography only)
It allows you to easily specify the number of prints to be made, imprinting dates and so on. Before using this function, confirm that your printer or commercial photo printing service supports DPOF. When printing on your home printer, be sure to observe the operating instructions for the printer.

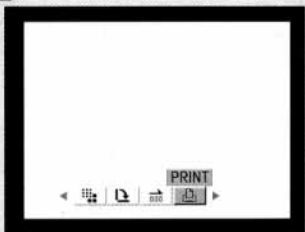

2







1 Set the mode dial to “” and turn on the camera.

2 Press the “D MENU” button and use “” or “” on the “” button to select “” (PRINT) and press the “” button.

The [SETTING PRINT] screen appears.

3





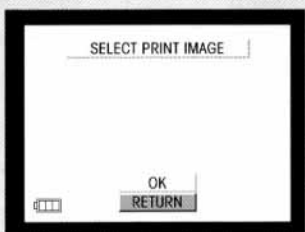

3 Use “” or “” on the “” button to select [PRINT] and press the “” button.

The [SELECT PRINT IMAGE] screen appears.

4



4 Use “” or “” on the “” button to select the image. Then use “” to select [OK] and press the “” button.

The [SETTING PRINT] screen appears.

5

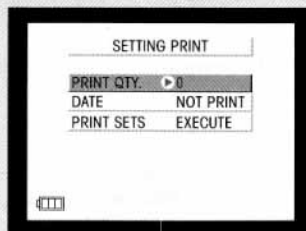

5 Use “▲” or “▼” to select [PRINT QTY] and press the “▶” button.

6 Use “▲” or “▼” to select the number of prints and press the “▲” button.

6

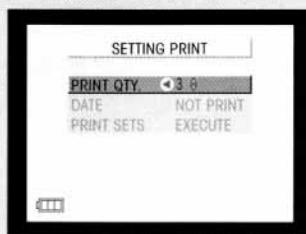

7 Use “▲” or “▼” to select [DATE] and press the “▶” button.

8 Use “▲” or “▼” to select [PRINT] or [NOT PRINT] and press the “▲” button.

9 Use “▲” or “▼” to select [PRINT SETS] and press the “▶” button.

8

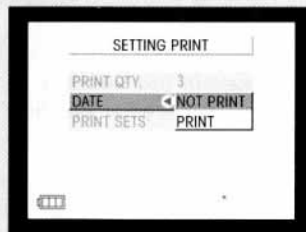

10 Use “▲” or “▼” to select [EXECUTE] and press the “▲” button to confirm selection of the DPOF settings.

The camera returns to the [SETTING PRINT] screen.

- To make DPOF settings for other images, repeat steps 3 to 10.
- To cancel a setting in Step 10, select [CANCEL].

10

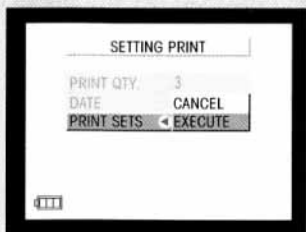

3



<Setting index printing>

This function allows you to prepare for printing a list of the images stored on a memory card.

Perform the first two steps in the Section "[PRINT] Using DPOF to Prepare for Printing" (P78) then perform the following steps.

3 Use "▲" or "▼" on the "⊙" button to select [INDEX] and press the "▶" button. The [SETTING INDEX PRINT] screen appears.

4



4 Use "▲" or "▼" to select [SET UP INDEX PRINT] and press the "⏏" button to complete the setup.

The camera returns to the [SETTING PRINT] screen.

3



<Canceling all print settings>

Perform the first two steps in the Section "[PRINT] Using DPOF to Prepare for Printing" (P78) then perform the following steps.

3 Use "▲" or "▼" on the "⊙" button to select [ALL RESET] and press the "▶" button.

The [DPOF SETTING CLEAR?] screen appears.

4 Use "▲" to select [EXECUTE] and press the "⏏" button to complete the setup.

The camera returns to the [SETTING PRINT] screen.

4

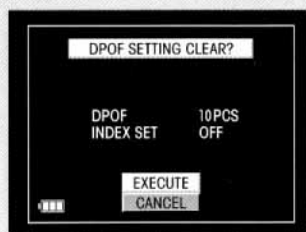



Playing and Erasing

Playing and Erasing Movies

1. Playing Movies

1

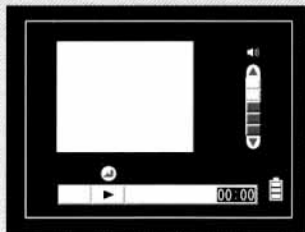

3

During playback



Frame-by-frame playback



4





Connect the camera to the AC adapter for long shooting sessions.

- Check that a memory card is inserted.



1 Set the mode dial to “” and turn on the camera.



The screen in the figure is displayed during movie playback.

2 Use “” or “” on the “” button to select the image to play back.

- Use multiple playback (P69) to simplify selection when the card contains many images.

3 Press the “” button to start playback and the playback screen shown in the illustration appears.

Use “” or “” to toggle between frame-by-frame playback either in forward or reverse direction during playback. When the buttons are held down more than two seconds, images are continuously played frame-by-frame either in forward or reverse direction.

Use “” or “” during playback to adjust the sound volume.

- Pressing the “” button during frame-by-frame playback either in forward or reverse direction starts movie playback.
- Sound is muted during frame-by-frame playback or reverse frame-by-frame playback.

4 Press the “” button to stop playback.

Use “” or “” to select the next image to play back.

2. Protecting Movies

You can use this function to protect important images from accidental erasure. This function is particularly convenient for erasing multiple images when used together with the erase all function (P84).

- Note that although protected images remain after using the erase all function, the format function deletes every image on the card.

2



3

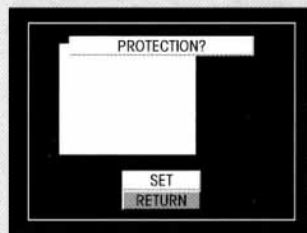

4



1 Set the mode dial to "▶" and turn on the camera.

2 Press the "D MENU" button and use "◀" or "▶" on the "⊙" button to select "🔑" (PROTECT) and press the "▲" button. [PROTECTION?] appears on the LCD monitor.

3 Use "◀" or "▶" on the "⊙" button to select the image that is to be protected.

4 Use "▲" to select [SET] and press the "▲" button to complete protection. Then the "🔑" icon and [PROTECT OFF?] appears on the LCD monitor.

- To unprotect the image, use "▲" to select [SET] and press the "▲" button (The "🔑" icon is turned off.)

To protect further images, repeat the procedures in steps 3 and 4.

5 Press the "D MENU" button to end the operation.

- To check a protected image after making these settings, look for the "🔑" icon in multiple playback (P69).

3. Erasing Movies

2

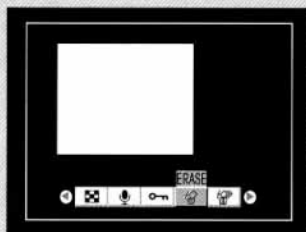

4

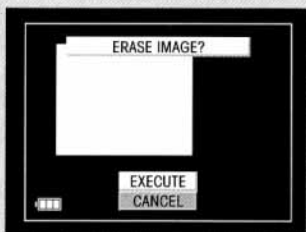

<Erasing individual images>

- 1 Set the mode dial to "▶" and turn on the camera.
- 2 Press the "D MENU" button and use "◀" or "▶" on the "⊙" button to select "🗑" (ERASE) and press the "▶" button.
[ERASE IMAGE?] appears on the LCD monitor.
- 3 Use "◀" or "▶" to select the image that is to be erased.
- 4 Use "▲" to select [EXECUTE] and press the "▶" button.

- When the image has been erased, the next image on the card will be displayed automatically.
- When an image with sound is erased, both the image and the sound are erased.
- To delete protected images, cancel the protection (P83) first.

2

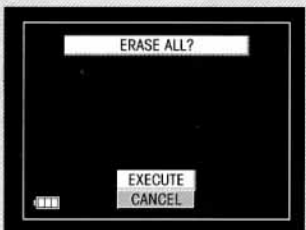
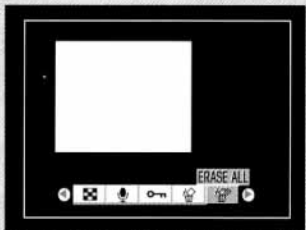

<Erasing All Images>

- 1 Set the mode dial to "▶" and turn on the camera.
- 2 Press the "D MENU" button and use "◀" or "▶" on the "⊙" button to select "🗑" (ERASE ALL) and press the "▶" button.
[ERASE ALL?] appears on the LCD monitor.
- 3 Use "▲" to select [EXECUTE] and press the "▶" button.

- When all images have been erased, the [NO IMAGE] message is displayed. If a protected image is present, that image is displayed.
- When an image with sound is erased, both the image and the sound are erased.
- To delete protected images, cancel the protection (P83) first.
- It may not be possible to erase images recorded by other cameras.

How to Use the Camera Setup Functions

1. Setup Function Lists

As shown below, the "SET UP C." has seven functions while the "SET UP D." has 15. Thus the setup function provide a total of 22 functions. The menu functions are in their default settings when the camera is purchased. (The functions in the "Default setting" column.)

To change the setup settings, follow the instructions in "2. How to Change Setup Settings" (P87).

<"SET UP C." List>

Item	Menu content	Default setting	Setting			
1. DEFAULT FLASH		⚡ AUTO	⚡👁️ AUTO	⚡ OFF	⚡	⚡👁️👁️ AUTO
2. ABC		(0)/+/-	+/(0)/-			
3. AFL HOLD TIME		1 FRAME ONLY	UNTIL OFF			
4. AFL FUNCTION		AF LOCK	AF-AE LOCK			
5. EXP COMP TIME		UNTIL OFF	UNTIL CANCEL			
6. EXP COMP STEP		0.3EV	0.5EV			
7. MF HOLD TIME		UNTIL OFF	UNTIL CANCEL			

<"SET UP D." List>

Item	Menu content	Default setting	Setting			
1. BRIGHT CNTRL		STANDARD	+2	+1	-1	-2
2. DATE		2002.01.01	-	-	-	-
3. INSERT DATE		NO DATE	WITH DATE			
4. FORMAT		-				
5. POWER SAVE		3MIN.	1MIN.	6MIN.	NO PWR OFF	
6. DIGITAL ZOOM		OFF	ON			
7. BEEP		+2	OFF	+1	+3	
8. SHUTTER VOL		+2	OFF	+1	+3	
9. COLOR SELECT		BLUE	PURPLE	RED	YELLOW	
10. START SCREEN		CONTAX screen	User setting	OFF		
11. AUTO PLAYBACK		OFF	2 SEC	4 SEC		
12. LANGUAGE		JAPANESE	ENGLISH	FRANÇAIS	DEUTSCH	ESPAÑOL
13. VIDEO OUT		NTSC	PAL			
14. FILE NO.		-				
15. MODE RESET		-				

2. How to Change Setup Settings

2

<SET UP C.>

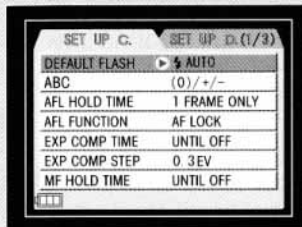

<SET UP D.>

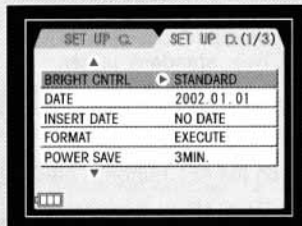

3, 4 Example: changing the DEFAULT FLASH

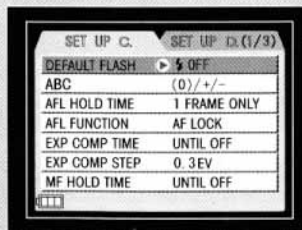

1 Set the mode dial to "SETUP" and turn on the camera.

2 Press the "C MENU" button to display the "SET UP C." item.

Press the "D MENU" button to display the "SET UP D." item.

- "SET UP D." consists of three screens (1/3 - 3/3). Use "▲" or "▼" on the  button to select items.

3 Use "▲" or "▼" on the  button to select the desired item and press the "▶" button.

The menu contents are displayed.

4 Use "▲" or "▼" on the  button to select the desired setting and press the "▶" button.

The camera returns to Setup Menu display.





- For information on how to set up DATE, refer to P17.
- For information on how to set up START SCREEN, refer to P93.

3. Setup Menu Contents

<SET UP C.>

1. DEFAULT FLASH

You can select the flash mode to be used in the exposure mode (P or Av) when the camera is turned on.

-  **AUTO** : Auto flash mode
-  **AUTO** : Red-eye reduction auto flash mode
-  **OFF** : Flash-off mode
-  : Fill-in flash mode
-  **AUTO** : Night portrait flash mode

2. ABC

You can select the sequence of exposure compensation values during ABC exposure.

- ① (0)/+/- exposures are made in the following order: standard, over, under.
- ② +/(0)/- exposures are made in the following order: over, standard, under.

- For details on ABC exposure, refer to P50.

3. AFL HOLD TIME

You can select the time that AFL (auto focus lock) is maintained when the AFL button is pressed.

- ① 1 FRAME ONLY canceled after one frame
- ② UNTIL OFF Valid as long as the camera is on (canceled when the camera is turned off).

- For information on exposures using the AFL button, refer to P40.

4. AFL FUNCTION

This function allows you to change AFL button functions.

- ① AF LOCK AF (auto focus) is locked.
- ② AF-AE LOCK AF (auto focus) and AE (exposure) are locked.

- For information on exposures using the AFL button, refer to P40.

5. EXP COMP TIME

You can change the time period that the exposure compensation setting remains valid.

- ① UNTIL OFF Valid as long as the camera is on
(canceled when the camera is turned off).
- ② UNTIL CANCEL Exposure compensation is valid until canceled
(turning the camera off does not cancel the setting).

- For details on exposure compensation, refer to P43.

6. EXP COMP STEP

You can change the exposure compensation steps for ABC exposure.

- ① 0.3 EV sets the exposure compensation steps to ± 0.3 EV.
- ② 0.5 EV sets the exposure compensation steps to ± 0.5 EV.

- For details on ABC exposure, refer to P50.

7. MF HOLD TIME

You can change the time that manual focus and the distance setting are held.

- ① UNTIL OFF the setting remains in effect while the camera is on and is canceled when the camera is turned off.
- ② UNTIL CANCEL ... Until MF setting is canceled with the "MF/MF" button (turning the camera off does not cancel the setting).

<SET UP D.>

1. BRIGHT CNTRL (LCD brightness control)

The LCD monitor can be set to one of five brightness levels.



2. DATE

This function sets camera date and time. For details on settings, refer to P17.

3. INSERT DATE

You can determine whether the "DATE" is to be imprinted on the recorded image or not.

- ① NO DATE, ② WITH DATE (A date imprint once made cannot be erased.)

4. FORMAT (memory card initialization)

This function erases all images and sound recorded on a memory card. Use this function with care since even protected images are erased.

- For details on "FORMAT", see page P92.

5. POWER SAVE

The time until the camera is automatically turned off when left on. This function prevents battery depletion if you forget to turn the camera off.

Select one of the following: ① NO PWR OFF, ② 1MIN., ③ 3MIN., ④ 6MIN.

- The default setting is 3MIN. When ① NO PWR OFF is selected, the camera is not turned off automatically. Do not forget to turn off the power when not using the camera.

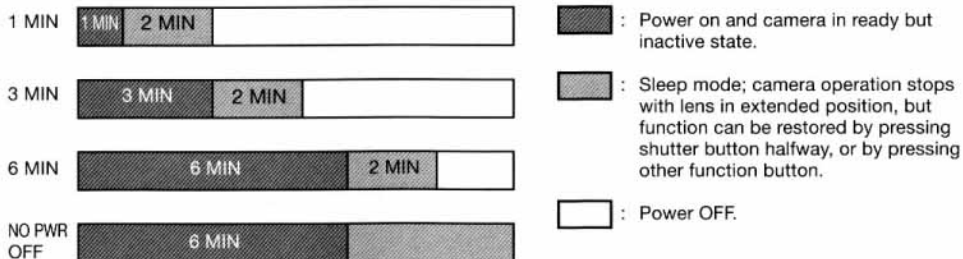

6. DIGITAL ZOOM

In the "Av, P" modes, in addition to the optical zoom, this zoom produces an electronically rendered zoom. It enables the camera together with the optical zoom to produce 12x zoom images. The digital zoom is activated by pressing the "T" (telephoto) zoom button until you reach maximum optical zoom ratio, then lift your finger off the button temporarily and press the button again to engage the digital zoom. The zoom ratio is indicated on the LCD monitor when the digital zoom is used.

- ① OFF The digital zoom cannot be used.
- ② ON The digital zoom can be used (x1.3, x1.6, x2.0, x3.0, x4.0)
- The digital zoom uses interpolation to enlarge the image. Note that picture quality deteriorates as images are enlarged.
- Use the LCD monitor to view digital zoom images. The optical viewfinder cannot be used to view digital zoom images.

7. BEEP

The beep can be adjusted.

Select one of the following: ① OFF, ② +1, ③ +2, ④ +3

- The default setting is ③ +2
- This also adjusts the sound when the camera is turned on.

8. SHUTTER VOL

Adjusts the shutter volume.

Select one of the following: ① OFF, ② +1, ③ +2, ④ +3

9. COLOR SELECT

The color of the cursor in the mode menus and in menu selections can be changed.

Select one of the following: ① BLUE, ② PURPLE, ③ RED, ④ YELLOW

10. START SCREEN

The start screen, which is displayed when the camera is turned on, can be set to one of the following three types:

- ① CONTAX screen the default setting
- ② User customized screen an image stored on the memory card can be used as start screen.
- ③ OFF screen (The start screen cannot be displayed.)
- For details, refer to "Setting a Start Screen" (P93).

11. AUTO PLAYBACK

The camera can be set up so that images are automatically displayed as they are taken. (still images only)

You can also set the time they are displayed.

① OFF (Not automatically displayed), ② 2 SEC, ③ 4 SEC

12. LANGUAGE

You can select one of the following five languages as the language used on the LCD monitor.

① JAPANESE, ② ENGLISH, ③ FRANÇAIS, ④ DEUTSCH, ⑤ ESPAÑOL

13. VIDEO OUT

The video output of the camera can be set to the NTSC or PAL system. The TV color system varies by country. When you are traveling, set the camera to the TV system of the country you are in.

- The NTSC system is used in Japan and America.

14. FILE NO.

A sequential number is assigned to the file names of new images as they are created, and the files are stored in a folder named "100CXBOX". FILE NO. allows you to create new folders on the memory card. The new files in the folder are assigned sequential numbers starting from 0001. This makes it easy to group image data for separate scenes in separate folders.

- Folders 100 to 999CXBOX can be created.
- When you wish to return the folder number to 100CXBOX, perform FILE NO. without inserting a memory card. This resets the folder number to 100CXBOX and the file name to KICX0001.jpg.

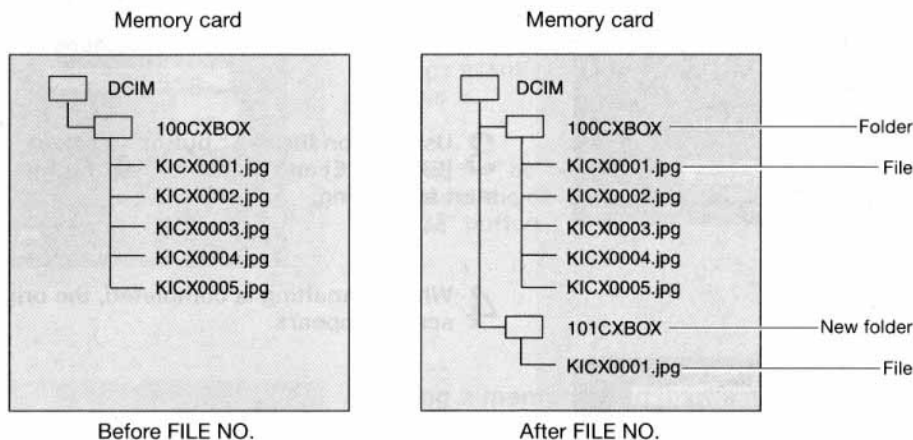

15. MODE RESET

Resets all camera settings except the DATE, VIDEO OUT and LANGUAGE [exposure mode (P, Av, M, S)] to their factory defaults. (For details, see P105.)

4. "FORMAT" - Initializing the memory card

2

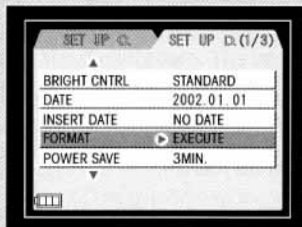

Use format to initialize a new memory card or to delete all data on a card.

- Format deletes all data and folders on a memory card. Use this function with care since also protected folders are deleted.

1 Set the mode dial to "SETUP" and turn on the camera.

2 Press the "D MENU" button and use "▲" or "▼" on the "D MENU" button to select [FORMAT] and press the "▶" button. [FORMATTING?] appears on the LCD monitor.

3 Use "▲" on the "D MENU" button to select [EXECUTE] and press the "▶" button to start formatting.

4 When formatting is completed, the original screen appears.

3

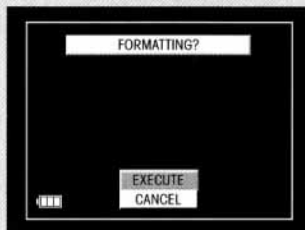

5. Setting a Start Screen

2

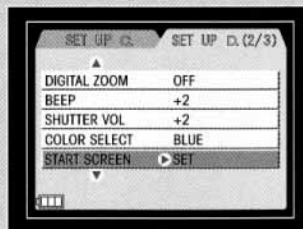

You can select one of the following three screens as the start screen.



- ① CONTAX screen (factory default)
- ② User customized screen an image stored on a memory card can be used as the start screen
- ③ OFF screen no start screen

1 Set the mode dial to “SETUP” and turn on the camera.

3



2 Press the “D MENU” button and use “▲” or “▼” on the “” button to select [START SCREEN] and press the “▶” button. [SELECT START SCREEN] appears on the LCD monitor.

3 Use “◀” or “▶” on the “” button to select the desired start screen and press the “” button.

4

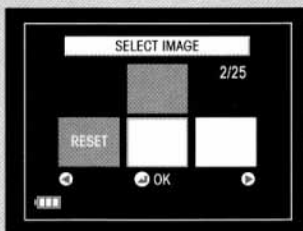

<Using a memory card image as start screen>



4 Select the center image in Step 3 above and press the “▼” button.

[SELECT IMAGE] appears and the memory card images are displayed.

- Selecting [RESET] cancels the selected image from the user customized screen.

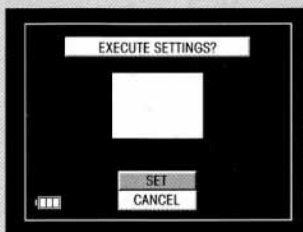
6



5 Press “◀” or “▶” on the “” button to select the desired image and press the “” button.

[EXECUTE SETTINGS?] is displayed.

6 Press “▲” on the “” button to select [SET].

The camera returns to the [SELECT START SCREEN] and the desired image is displayed at the center.

7 Press the “” button.

Connecting to Other Devices

1. Viewing Images on a TV

You can play back recorded images on a TV at home or your travel destination.

1 Connect the camera to the TV with the supplied video cable.

- Make sure that both the camera and the TV are turned off before connecting.
- Connect the AC adapter to the camera for long viewing sessions.

2 Turn on the TV and the camera and set the mode dial on the camera to "▶" to view images on the TV.

This connection allows you to shoot and play back images as well as use the SETUP functions.

- Set the TV to video input mode.
- The camera LCD monitor is off while the video cable is connected.

The video output of the camera can be set to the NTSC or PAL system. The TV color system varies by country. When you are traveling, set the camera to the TV system of the country you are in. For details on settings, refer to page 87.

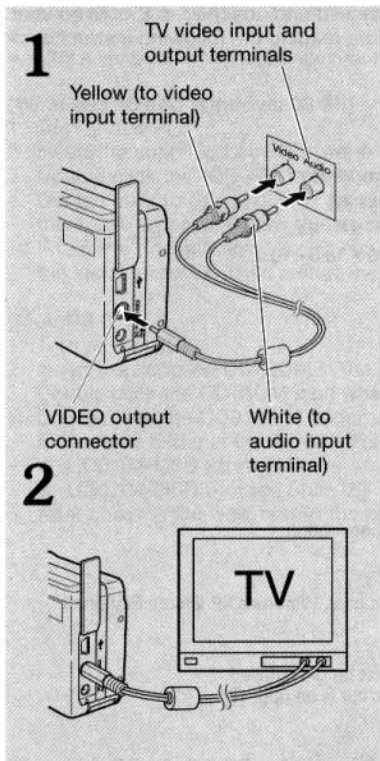

2. Connecting to a PC

Images taken by this camera can be viewed, copied and processed and attached to E-mail on your PC. First find out what operating system your PC is using before reading the following instructions.

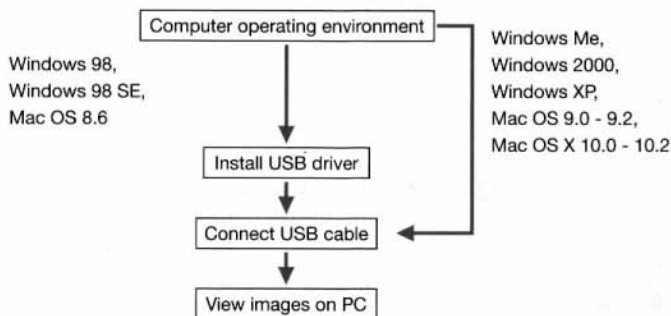

<1. Computer Operating Environment>

- The PC must provide a USB terminal as standard to allow camera connection.
- A CD-ROM drive is required to install the provided software.

[Windows environment]

- Windows 98, Windows 98 SE, Windows Me, Windows 2000 Professional, Windows XP (Home Edition or Professional) must be preinstalled.

[Macintosh environment]

- Mac OS 8.6 to 9.2 or OS X 10.0 to 10.2 (excluding OS X server) must be preinstalled.
- * Connection may not be possible with the above operating systems, if it is an upgrade.

Installing a USB driver

A USB driver must be installed for Windows 98, Windows 98 SE and Mac OS 8.6. A USB driver is provided on the CD-ROM supplied with the camera.

Connect the USB cable after installing the USB driver. The USB driver cannot be correctly installed if the USB cable is connected. If the USB cable was connected during the install process, remove the device as described on page 101.

The supplied CD-ROM contains the following software.

- USB driver
- PIXELA ImageMixer Ver 1.0 (image processing and management software)

[Windows 98 and Windows 98 SE]

1. Turn on the PC.
2. Insert the supplied CD-ROM in the CD-ROM drive of the PC.
3. Double click the "CD-40" folder from "My Computer" to open the CD-ROM.
4. Double click to open "Disk 1" from "Eng" folder then double click the SET UP.EXE file to start the install process. Follow the on-screen instructions to complete the install process.
5. When the "InstallShield Wizard has been completed" message is displayed, click "Finish" to end the install process. Then restart the computer.

[Mac OS 8.6]

1. Turn on the PC.
2. Insert the supplied CD-ROM in the CD-ROM drive of the PC.
3. Double click the CD-ROM icon when it appears on the desktop to open it.
4. Double click the UD0104(E) folder to open the window and copy the following files to the Extensions folder in the System Folder on the Macintosh hard disk.
 - UD0104-USB Storage Driver
 - UD0104-USB Storage Shim (E)
5. After copying the files, restart the computer.

<2. Connecting the USB cable to the PC>

Windows Me, Windows 2000, Windows XP, Mac OS 9.0 to 9.2 and Mac OS X 10.0 to 10.2 come with a USB driver installed. Perform the following steps to connect a USB cable.

Connect the camera to the computer using the supplied USB cable.

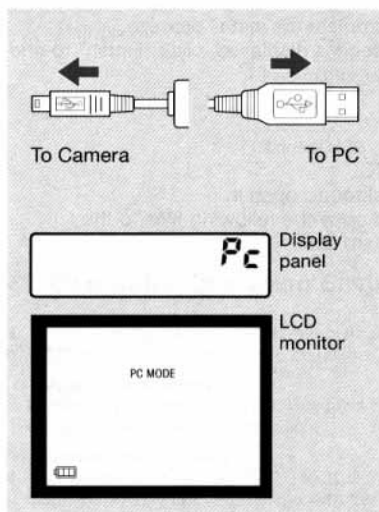

Note

A different size connector is used at each end of a USB cable. Connect the small USB connector to the camera and the large one to the PC.

When the camera is turned on, "PC MODE" is displayed on the LCD monitor and "Pc" appears on the display panel indicating that the camera can be controlled from the PC.

- The self-timer LED flashes at this time.
- * The card access LED flashes when images are viewed or copied on a PC. Do not disconnect the USB cable or turn off the PC when the card access LED is flashing.

■ Disconnecting a USB cable

Disconnect a USB cable from a PC according to the following steps.

[Windows Me]

1. Double click the "Unplug or Eject Hardware" icon on the task bar in the lower right corner of the desktop.
2. Select "USB Disk" and click "Stop".
3. Select "USB Disk" and click "OK".
4. Click "OK" when a message appears.
5. Disconnect the USB cable from the PC and the camera.

[Windows 2000]

1. Double click the "Unplug or Eject Hardware" icon on the task bar in the lower right corner of the desktop.
2. Select "USB Mass Storage Device" and click "Stop".
3. Select "USB Mass Storage Device" and click "OK".
4. When the message "Removing Safely" appears, click "OK".
5. Disconnect the USB cable from the PC and the camera.

[Windows 98, Windows 98SE and Windows XP]

Turn off the camera and disconnect the USB cable.

[Mac OS]

Drag the "Untitled" folder on the desktop into the trash. Disconnect the USB cable when the "Removing Safely" message appears or the "Untitled" icon is no longer seen.

<3. Viewing images on a PC>**[Windows]****Check the following.**

- That software required for viewing images is installed on the PC.
(QuickTime 4.1 or later must be installed for viewing movies.)
- Insert a memory card in the camera.

<Procedure>

1. Insert a memory card in the camera.
2. Connect an AC adapter to the camera and turn on the power.
3. Connect the camera to the PC with the USB cable.
(“PC MODE” appears on the LCD monitor of the camera.)
4. A new “Removable Disk” icon appears in “My Computer”. Double click the icon to open it.
Check if the cable is properly connected when “Removable Disk” or “Untitled” does not appear in the “PC MODE”.
5. Open “XXXCXBOX” or “RESIZE” folder in DCIM, select the image file in the folder you want to view and double click it.

[Macintosh]**Check the following.**

- That software required for viewing images is installed on the PC.
(QuickTime 4.1 or later must be installed for viewing movies.)
- Insert a memory card in the camera.

<Procedure>

1. Insert a memory card in the camera.
2. Connect an AC adapter to the camera and turn on the power.
3. Connect the camera to the PC with the USB cable.
(“PC MODE” appears on the LCD monitor of the camera.)
4. An “Untitled” icon appears on the desktop. Double click the icon to open it.
5. Open “XXXCXBOX” or “RESIZE” folder in DCIM, select the image file in the folder you want to view and double click it.

[Windows]

New removable disk

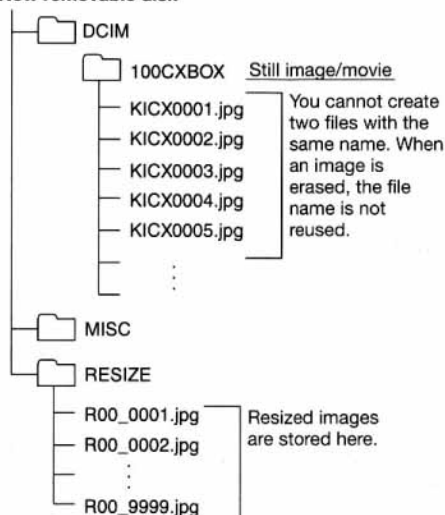

[Macintosh]

Untitled

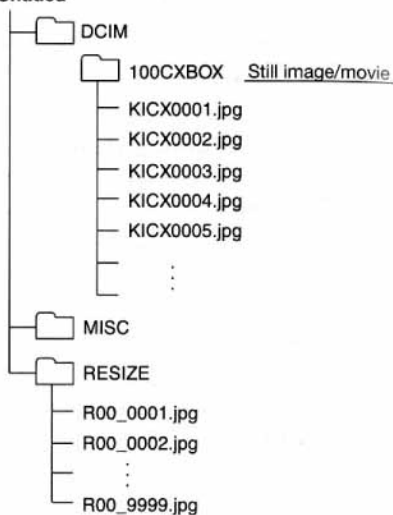

PC communications

It may not be possible to reestablish a connection to a PC after resume from suspend or to a PC that recovers from a sleep function.

Note

- When you want to process an image (for example, resizing or rotating it), copy it to the PC and process the copied image not the original.
Note that if you process the original image on the memory card, you will no longer be able to view it on your camera.
- Do not format memory cards from your PC.
- Do not delete memory card data from the PC and do not move image data to the PC. Use only the camera to delete memory card data.

<4. Removing Devices>

The PC will not detect the camera unless the USB driver is correctly installed. If the driver was not correctly installed, use the following procedure to remove it. Then reinstall the driver according to the instructions in the instruction manual.

[Windows 98 and Windows 98 SE]

1. Turn on the PC and start up Windows.
2. Connect the camera USB terminal to the USB terminal on the PC using the supplied USB cable.
3. Load a memory card in the camera, connect the AC adapter to the camera and turn it on.
4. Open the "Device Manager" on the PC.
 - ① Right-click "My Computer" and select "Properties".
 - ② Click the "Device Manager" tab in the "System Properties" window.
5. Select "Other Devices" and click "Remove" for the icon with the question mark (?CONTAX TvsD).
6. When a screen for confirming device deletion appears, click "OK".
7. Turn off the camera before disconnecting the USB cable and restart the PC.

<5. When the driver is no longer needed>

Use the following procedure to uninstall a no longer needed driver.

[Windows 98 and Windows 98 SE]

1. Double click "My Computer".
2. Double click "Control Panel".
3. Double click "Add/Remove Programs" and select "kyocera Camera USB Device 2".
4. Click "Add/Remove" to display "Are you sure you want to uninstall this product?" and click "Yes". This completes the driver uninstall process.

[Mac OS 8.6]

1. Double click the System Folder on the Macintosh hard disk.
2. Double click Extensions folder and drag the following files to the trash.
 - UD0104-USB Storage Driver
 - UD0104-USB Storage Shim (E)

<6. Installing PIXELA ImageMixer Ver.1.0>

[Windows]

1. Open the [PIXELA] folder in the CD-ROM and double-click the [ImInst] icon.
2. Double-click [PIXELA ImageMixer] in the menu to start installation.
3. Follow the instruction on the screen to complete the installation.

[Macintosh]

1. Open the [PIXELA] folder in the CD-ROM and double-click the [Setup Menu] icon.
2. Select and double-click the language to start installation.
3. Follow the instruction on the screen to complete the installation.

For more details on the software, refer to the following user support center of PIXELA Corp. or the website (<http://www.imagemixer.com>).

User support center

Area	Telephone	Operating hours
North America	+1-213-341-0163	9:00 - 17:00
Europe	+44-1489-564-764	9:00 - 17:00
Asia	+63-2-438-0090	9:00 - 17:00



Other Information

1. Troubleshooting

If you suspect a malfunction, please check the following troubleshooting diagnostic tips before sending your camera for professional service.

Symptom	Probable Cause	Remedy	Page
Nothing appears on the LCD monitor	Batteries are exhausted or the lithium-ion battery pack has not been installed.	Install the lithium-ion battery pack in the camera and charge.	15
	The POWER SAVE function has turned off the power.	Press the POWER button to turn on the power.	–
The LCD monitor is off	The POWER SAVE function may cause the camera to enter the sleep mode when it is inactive for a preset period of time.	Press the shutter button halfway, or press any other function button to return the camera to normal operating condition. Since camera response differs depending on the setting of the POWER SAVE function, refer to P89 for details.	89
	The video cable is connected to the camera.	Disconnect the video cable.	95
	The LCD monitor is turned off.	Press the DISPLAY button to turn on the LCD monitor.	26
	A strong magnet or other magnetic source is located too near the camera.	Move the camera away from the magnet or electromagnetic field.	–
The remaining exposure counter does not change even though an image was recorded.	The file size of the recorded image was very small.	This depends on the image quality setting and subject condition and is not a malfunction.	–
No images appear on the TV monitor.	The video output does not match TV.	Adjust video output to the TV.	91
The image cannot be erased. The  icon is displayed.	The image is protected.	Cancel protection.	72, 83
The image cannot be erased.	Image data was recorded on a different camera.	This image cannot be erased by this camera. You can use FORMAT to erase it, but then all images will be erased.	92
The remaining exposure counter does not change even though an image was erased.	The file size of the erased image was very small.	This depends on the image quality setting and subject condition and is not a malfunction.	–
The camera cannot be charged.	The lithium-ion battery pack has not been installed.	Install the lithium-ion battery pack in the camera.	15
	The lithium-ion battery pack has been installed with the polarities reversed.	Reinstall the battery pack properly.	15
	The AC adapter is not correctly connected.	Connect the AC adapter correctly.	–
The camera cannot be charged or charging stops before being completed. The caution LED flashes slowly.	The ambient temperature is too high or too low causing the camera's protection circuits to terminate charging.	Charge the camera at temperatures between +10 to +30°C (The camera can still be charged at temperatures between +5 and +40°C, but charging takes somewhat longer.)	–

Symptom	Probable Cause	Remedy	Page
The camera becomes hot.	The LCD monitor consumes a fair amount of power and becomes hot when used for a longer time.	This is not a malfunction, but allow the camera to rest when it becomes hot.	-
The caution LED lights.	The flash is charging.	Allow the flash to complete charging before pressing the shutter release button.	13
The caution LED flashes rapidly.	Camera shake warning. The shutter speed is too slow.	Place the camera on a tripod.	13
The lens cannot focus on the subject. The standby LED and the in-focus indicator flash.	The subject is difficult to focus on.	Focus on a part of the subject that makes focusing easier, lock focus, recompose the picture and shoot.	39
Images cannot be rotated, DPOF cannot be set and images cannot be protected.	The SD memory card is write protected.	Cancel SD memory card write protection, then try again.	16

Messages and remedies

Message	Probable Cause	Remedy	Page
"MEMORY CARD FULL"	The memory card has run out of free space.	Insert a new memory card or erase no longer needed images. Or try using a lower resolution.	73
"NO CARD"	No memory card is loaded.	Insert a memory card.	16
"WRITE PROTECT"	The write protect switch on the SD memory card is engaged.	Cancel SD memory card write protection or insert a different card.	16
"CARD ERROR"	This memory card was formatted on a different camera.	Format the card.	92
	This memory card contains a non-compatible format.	Format the card or insert a different card.	92
"NO IMAGE"	The card is not correctly loaded.	Insert the card correctly.	16
	The memory card is empty.	Insert a card with image data.	-
"PLAYBACK NOT POSSIBLE"	The memory card contains image data of a non-compatible file format.	Insert a different card or format the card.	92
"COVER OPENED"	The memory card door is open.	Close the memory card door.	16
"LOW BATTERY"	Batteries are exhausted.	Charge the battery pack or use the AC adapter.	15

2. Modes and Function Settings

List of modes and function settings during shooting, during MODE RESET* and when the camera is turned off.

Mode	Item	When camera is off	MODE RESET*
Av, P, movie	AF lock using AFL button	Cancel (Normal AF)	Normal AF
Av, P	Flash mode	Cancel (DEFAULT FLASH)	⚡ AUTO
Av, P, movie	Macro AF	Cancel (Normal AF)	Normal AF
Av, P, movie	MF (manual focus)	Cancel (Normal AF)	Normal AF
Av, P, movie	Exposure compensation	Cancel (±0)	±0
Av, P, movie	WB (white balance) selection	Setting persists	AUTO
Av, P	ISO	Setting persists	AUTO
Av, P, movie	Self-timer/remote control	Cancel (OFF)	OFF
Av, P, movie	AF area selection	Setting persists	Wide focus frame
Av, P	METERING mode	Setting persists	EVALUATION
Av, P	ABC	Cancel (0.0)	0.0
Av, P	DRIVE mode	Setting persists	S
Av, P	LONG EXP.	Cancel (OFF)	OFF
Av, P	Flash exposure compensation	Setting persists	Normal
Movie	SOUND ON/OFF	Setting persists	ON
Av, P, movie	COLOR MODE	Setting persists	COLOR
Av, P, movie	PIXELS	Setting persists	Av, P: 2560 x 1920 Movie: 320 x 240
Av, P	QUALITY	Setting persists	NORMAL
Av, P	WB/BKT	Cancel (OFF)	OFF
Av, P	SHARPNESS	Setting persists	0 (STANDARD)
Av, P	CHROMA	Setting persists	0 (STANDARD)
"SET UP C"	DEFAULT FLASH	Setting persists	⚡ AUTO
	ABC	Setting persists	(0)/+/-
	AFL HOLD TIME	Cancel (1 FRAME ONLY)	1 FRAME ONLY
	AFL FUNCTION	Setting persists	AF LOCK
	EXP COMP TIME	Setting persists	UNTIL OFF
	EXP COMP STEP	Setting persists	0.3 EV
	MF HOLD TIME	Setting persists	UNTIL OFF
	BRIGHT CNTRL	Setting persists	STANDARD
	DATE	Setting persists	Not reset
	INSERT DATE	Setting persists	NO DATE
"SET UP D"	FORMAT	-	-
	POWER SAVE	Setting persists	3 MIN.
	DIGITAL ZOOM	Setting persists	OFF
	BEEP	Setting persists	+ 2
	SHUTTER VOL	Setting persists	+ 2
	COLOR SELECT	Setting persists	BLUE
	START SCREEN	Setting persists	CONTAX screen
	AUTO PLAYBACK	Setting persists	OFF
	LANGUAGE	Setting persists	Not reset
	VIDEO OUT	Setting persists	Not reset
	FILE NO.	-	-
	MODE RESET	-	-

* MODE RESET: the camera settings except the DATE, VIDEO OUT and LANGUAGE are reset to their factory defaults.

3. Main Specifications

Type:	Digital still camera with record, playback and erase functions
Recording media/ recording formats:	SD memory card/MMC (multimedia card, DCF (Design rule for Camera File system), JPEG (Exif Ver. 2.2), DPOF (Digital Print Order Format)
Effective image pixels:	5 million
Image sensor:	1/1.8 square-pixel primary color filter and interlace readout system CCD (total of 5.25 million pixels)
Effective image pixels (still photography):	2560 x 1920, 1600 x 1200, 1280 x 960, 640 x 480
Effective image pixels (movie):	320 x 240, 160 x 120
Quality:	Two levels: FINE, NORMAL
Lens:	Carl Zeiss Vario-Sonnar T* 7.3 - 21.9 mm (equivalent to 35 - 105 mm in the 35 mm format), F2.8 - 4.8 (6 elements in 6 groups)
Aperture:	WIDE: F2.8, F3.3, F4.0, F4.7, F5.6, F6.7 TELE: F4.8, F5.6, F6.7
Digital zoom:	Digital zoom ratio (x1.3, x1.6, x2, x3, x4)
Focal point adjustment:	Video feedback autofocus and manual focus (distance can be set)
Shooting range: (Distance from the CCD)	AF: 0.6 m-∞ MF: 0.6, 0.7, 0.8, 1, 1.5, 2, 5 m, ∞ Macro (WIDE): 0.15~0.6 m
Exposure control:	
● Control system:	Programmed AE, aperture-priority AE, LT (long-time exposure)
● Metering system:	CCD multi-area evaluation, center-weighted and spot metering
● Metering range:	LV3 to LV16.5
● Exposure compensation:	+2.0 EV to -2.0EV (in 1/3 steps or 1/2 steps, can be set in SET UP C) ABC (± 0.3EV, ± 0.5EV, ± 1.0EV)
Shutter:	CCD electronic shutter, electronic shutter with independent aperture control 1 - 1/2000 sec LT setting: 1 sec, 2 sec, 4 sec, 8 sec
White balance:	Auto, sunlight, incandescent lighting, cloudy, fluorescent lighting, preset
Color modes:	Color, black and white, sepia
Sharpness:	+3 to -1 (5 steps)
Chroma:	+, 0, - (3 steps)
ISO:	AUTO, Manual setting (ISO 80 - ISO 400)
Viewfinder:	
● Optical viewfinder:	True image zoom viewfinder Field of view: 83%, magnification: 0.35 - 0.99, diopter adjustment +1 to -3 d
● LCD monitor:	1.6 inch 85,000 TFT color LCD monitor (354 x 240 dots), Field of view: 100%
Flash:	Built-in light metering flash/flash exposure compensation (± 1EV), Recycling time about 5 seconds (on full battery charge, at room temperature, based on our testing standards).
Flash modes:	① Auto flash mode, ② Red-eye reduction auto flash mode ③ Flash off mode ④ Fill-in flash mode, ⑤ Night portrait flash mode
AF modes:	① Wide AF ② Spot AF
Movie modes:	File format: AVI with or without sound
Movie recording time:	30 sec/time (320 x 240), 120 sec/time (160 x 120) The maximum recording time depends on the recording media PC playback environment: QuickTime 4.1 or later (Windows, Macintosh)
Still photography functions:	
● C.MENU:	Self-timer, remote control, AF mode selection, metering mode selection, ABC, Drive (S, C), LT (long-time exposure), flash exposure compensation
● D.MENU:	Color mode, pixels, quality, white balance bracketing, sharpness, chroma

Movie functions:

- C.MENU:
- D.MENU:

LCD monitor display:

Self-timer, remote control, AF mode selection
 With sound/without sound (movie), color mode, pixels
 Flash mode, white balance, metering mode, distance icon, drive icon (C), pixels, quality, remaining exposure counter, exposure compensation, shutter speed, aperture value, ISO, sharpness, chroma, digital zoom, self-timer, remote control, macro icon, MF, AFL icon, ABC icon, white balance bracketing icon, battery icon, date

Display panel functions:

Flash mode, macro icon, drive icon (C), remaining exposure counter, MF icon, AFL icon, exposure compensation icon, LT icon, battery icon
 Multiple image playback (6 images), recording (voice memo for adding comments to still images), protect, erase, erase all, resize, rotate, auto play, DPOF setting, close-up playback, thumbnail playback, movie (only movies recorded on this camera), histogram

Playback mode:

Up to 30 seconds can be recorded and played back per image
 File format: wav

Recording:**Resize:**

320 x 240 or 160 x 120
 Area for resizing can be selected.
 File format: jpg

Erase:

This function can be set to erase single images or all images.

Setup function:

- SET UP C:

Flash default setting, ABC, AFL HOLD TIME setting, AE lock for AFL button, EXP COMP TIME setting, EXP COMP STEP, MF HOLD TIME setting

- SET UP D:

LCD brightness adjustment, DATE setting, INSERT DATE, card FORMAT, POWER SAVE, DIGITAL ZOOM, BEEP, SHUTTER VOL, COLOR SELECT, SELECT START SCREEN, AUTO PLAYBACK, LANGUAGE (Japanese, English, German, French, Spanish), VIDEO OUT switching, FILE No. reset, MODE RESET

Video out:**I/O terminals:**

NTSC/PAL composite video signal switching system, sound output
 Video output connector, external power input connector, USB connector (mini-B)

Power supply:**Charge time:**

3.7 V lithium battery, 1500 mAh, dedicated AC adapter
 Approx. 6 hours (full charge, +10 to +30°C)

The number of images taken:

(using flash 50% of the time, 2590 x 1920 normal)*
 LCD monitor ON: approx. 260 frames
 LCD monitor OFF: approx. 310 frames

Continuous playing time:

Approx. 4 hours 30 minutes (when the LCD monitor is used)*

* The above is true according to Contax measuring standards when the battery is fully charged and the camera is used at room temperature with the supplied battery pack.)

Dimensions:

112 (W) x 60 (H) x 33 (D) mm
 (excluding LCD, lens and other projecting parts)

Weight:**Operating temperature:**

Approx 210 g (without batteries and recording media)
 0 to 45°C (no condensation)

Number of frames that can be shot at different resolutions

* When recording in one of the following modes using a 16 MB card. The number of frames that can be taken varies with quality and card type.

2560 x 1920	Approx. 4 to 6 frames (FINE), approx. 8 to 12 frames (NORMAL)
1600 x 1200	Approx. 10 to 15 frames (FINE), approx. 20 to 29 frames (NORMAL)
1280 x 960	Approx. 16 to 23 frames (FINE), approx. 30 to 43 frames (NORMAL)
640 x 480	Approx. 54 to 73 frames (FINE), approx. 88 to 112 frames (NORMAL)
Movie 320 x 240	Approx. 1 or 2 times (with sound, 30 sec recording)
Movie 160 x 120	Approx. 1 or 2 times (with sound, 120 sec recording)

* All descriptions and specifications are subject to change without notice.

A

AC Adapter	P2
AFL button	P25, 40
AUTO PLAY	P77
AUTO PLAYBACK	P90
"Av" Aperture-priority Auto	P30

B

Battery Pack	P2, 15
BEEP	P90

C

Camera case	P2
Camera shake	P18
Card access LED	P13
Caution LED	P13
CD ROM	P2, 97
Center-weighted Metering	P49
Charging the Battery Pack	P15
CHROMA	P57
Close-up	P67
"C MENU" button	P23, 46
COLOR mode	P54, 63
COLOR SELECT	P90
Commercial printing service	P78
Continuous Shooting	P51

D

DATE/TIME ADJUSTMENT	P17
DCIM	P74, 91
DEFAULT FLASH	P88
Device	P101
Digital Print	P3
DIGITAL ZOOM	P21, 90
Diopter adjustment	P18
DISPLAY button	P26
Display Panel	P12
"D MENU" button	P24, 54
DPOF	P78
Driver	P101

E

ERASE ALL	P73, 84
Erasing images	P73, 84
Erasing sound	P71
Evaluative Metering	P49
Exposure ABC	P50, 88
Exposure Compensation	P43, 60

F

FILE NO.	P91
Flash Exposure Compensation	P53
Flash Photography	P34
Focus Lock	P39
Folder	P91
FORMAT	P89, 92
Frame-by-frame playback (forward or reverse direction)	P82
Fully depressed	P20

H

Halfway depressed	P20
Histogram	P32, 68

I

INDEX PRINT	P80
In-focus indicator	P11, 29
INFORMATION	P32, 68
Initializing the memory card	P92
INSERT DATE	P18
ISO	P45

L

LANGUAGE	P90
LCD monitor	P11, 89
"LT" Longtime Exposure	P52

M

Macintosh	P96, 99
Macro Photography	P41
Manual Focus Photography	P42
Memory card	P2, 16
Metering Mode	P49
MODE RESET	P91
MULTI	P69
MultiMediaCard	P2

O

Optical viewfinder	P12, 27
Optical zoom	P21
Overexposure	P43

P	
Parallax	P27
PC	P96 – 101
PIXELS	P54, 63
Playback zoom	P32
Playing back sound	P71
Playing Movies	P82
Playing Still Images	P65
POWER button	P20
POWER SAVE	P89
“P” Program Auto	P29
Printer	P78
Program auto control diagram	P29
PROTECT	P72, 83

Q	
QUALITY	P54

R	
Recording	P33, 70
Recording Movies	P59
REC REVIEW	P22, 32
REC REVIEW button	P22, 32
Red-eye effect	P34
Remaining exposure counter	P11, 29
Remaining time that can be recorded	P59
Remote control	P2, 47
Reset button	P7
RESIZE	P74
ROTATE	P76

S	
SD memory card	P2, 16
Self-timer LED	P13
Self-Timer/ Remote Control Photography	P46, 61
SETTING PRINT/ALL RESET	P78, 80
Setup Functions	P85
SHARPNESS	P57
SHUTTER VOL	P20, 90
SINGLE	P69
Spot Auto Focus Photography	P48
Spot Metering	P49
Standby LED	P13
START SCREEN	P90, 93
Still Photography	P28
Strap	P5

T	
Trimming	P74
TV	P95

U	
Underexposure	P43
USB cable	P2, 98

V	
Video cable	P2, 95
VIDEO OUT	P91, 95

W	
WB (White Balance)	P44
WB/BKT	P56
White Balance	P44, 61
Windows	P96 – 101
With sound/No sound	P62
Write protect	P16

Z	
Zoom	P21