



EXILIM ケータイ

W53CA by CASIO

Basic Manual

CASIO

Contents/
Ready

Phone Call

Inputting
Characters

Address Book/
Pair Function

Mail

Camera

EZweb

EZ Navi

Simple Mode/
Teens Mode

Other
Functions

Troubleshooting/
Remote Ctrl Lock

Index

Introduction

Thank you for purchasing the W53CA.

Before using it for the first time, be sure to read the Basic Manual (this PDF manual) so as to know how to use it correctly. After you finish reading this manual, store it and the printed materials that come with the phone in a safe place for future reference.

Printed Manuals for the W53CA (Japanese)

The W53CA comes with a Basic Manual and an Instruction Manual.

For information about basic operation



Basic Manual

Refer to this English PDF manual.

For detailed information about each function



Instruction Manual

English version not available.

The following information is also available on the au website.

- To download the Basic Manual or Instruction Manual (<http://www.au.kddi.com/torisetsu/index.html>)
- To access a keyword searchable au On-Line Manual (<http://www.au.kddi.com/manual/index.html>)

You can also access the au On-Line Manual using EZweb.

EZweb Access

EZトップメニュー (EZ Top Menu)

→auお客さまサポート (au Customer Support)

→調べる (Information)

→オンラインマニュアル (On-Line Manual)

Info

- ◎ All mentions of “the W53CA” in this manual refer to “the EXILIMケータイ W53CA.”
- ◎ The typeface, fonts, and colors of the texts on the screens shown in this manual may differ from the actual contents. Also, certain icons and the scroll bars may be omitted.

Cellphone Etiquette

Mind your manners!

A cellphone always emits weak radio waves while it is turned on. Enjoy operation of your cellphone without forgetting to be considerate of those around you.

Some locations do not allow the use of cellphones.

- Using a cellphone while driving is dangerous and prohibited by the Traffic Control Law.
- Using a cellphone inside of an aircraft is prohibited by law. Be sure to turn off your cellphone before takeoff.



Watch out where you use your cellphone, and keep your voice down.

- Do not make calls at cinemas, theaters, museums, libraries, or other similar locations. Turn off the cellphone or use Manner Mode to ensure that the ring tone does not disturb others.
- When in public, move to a location where you will not be blocking traffic.
- On the Shinkansen, in a hotel lobby, or in other similar locations, move to a location where you will not disturb others.
- Take care to avoid talking on the phone in a loud voice.
- Before taking the picture of others, be sure to obtain permissions first.



Cellphone radio waves may interfere with electrical medical equipment.

- On a train or in other crowded locations, there is always the possibility that someone nearby may be wearing a pacemaker. Turn off your cellphone when you are in a crowded area.
- Follow the rules of hospitals and other medical facilities prohibiting the use or possession of cellphones.



Cellphone Basics

Features

Camera

Shoot photos and record movies, and send them by e-mail.

▶ Page 60



Hello Messenger

Enjoy meeting with the members using our original cartoon-like characters.



EZ Navi

EZ Navi Walk, Passenger Seat Navi, Evacuate Navi and Security Navi allow you to get various kinds of location information. They are all built-in functions.

▶ Page 72

EZ FeliCa

Use the cellphone for shopping by using electronic money, or use it as member's cards, point cards, and so on.

Mail

Send mail messages to other cellphones or to PCs.

▶ Page 50



Security Setup

Select either "Safety Buzzer" or "Hot Dial" as reliable setting function.

▶ Page 88

EZweb

Download "Chaku-Uta[®]," wallpaper, and other data.

▶ Page 67



PC Document Viewer

Display Word files, Excel files or PDF files, and so on.

PC Site Viewer

View WEB sites created for viewing on PCs.



Info

Your cellphone also has a powerful collection of other functions in addition to those above.

→ "Other Functions" (Page 88)

Manner Mode and Easy Voice Memo

Manner Mode

Use Manner Mode to turn off the ring tone so as not to bother others around you.



While the standby screen is displayed, hold down  for about one second.

▶ Page 36

Easy Voice Memo

If you cannot answer a call, Easy Voice Memo plays an answering message and records the caller's message.



While the standby screen is displayed, hold down  for about one second.

▶ Page 37

Checking Power, Signal Strength, and Battery Level

Normally leave the phone turned on.



The phone needs to be turned on to make and receive calls.

Hold down  for at least 1.5 seconds to turn on W53CA. After a while, W53CA turns on with tone and the standby screen appears.

▶ Page 14

You cannot talk on the phone if it is unable to receive a signal.



Signal strength is low in some areas, even if they are within the service area.

 indicates the current signal strength. ▶ Page 14

Keep an eye on the battery level.



The phone may not function properly if battery power is low.

 indicates the current battery level. ▶ Page 14

Never use your cellphone while driving!

Holding a cellphone in your hand, talking on a cellphone, or looking at a cellphone display to send mail or to perform any other operation while driving is prohibited by Japanese law. (Revised Traffic Control Law, effective November 1, 2004)

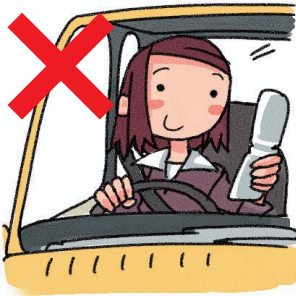

× Reading mail or looking at the display.

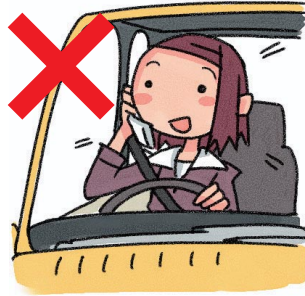



× Holding a cellphone in your hand to talk.

Turn off your cellphone or use Drive Mode while driving.

Drive Mode

In Drive Mode, the phone will play the message “ただいま車を運転しています。…” (I am driving right now...), and then ask the caller to leave a message using Easy Voice Memo.

While the standby screen is displayed, press , and then press  (ON). Next, press  (Drive Mode) to enter Drive Mode.



Beware of spam and One-ring Calls!

If you are getting spam

You can set up mail filters to block specific mail or spoof mail.

The following are the main features your cellphone uses to block spam.

- Blocking of “未承諾広告※” (unsolicited advertisement) mail
- Blocking of specific mail
- Blocking of spoof mail

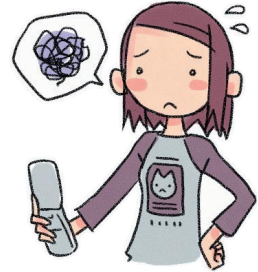

Page 57

Beware of One-ring Calls!

A “One-ring Call” (wan-giri in Japanese) rings your phone only once, in an attempt to make you call back to a service that automatically bills you very high charges.

If W53CA received a “One-ring Call,” the  icon appears at the head of an incoming record.

Incoming	Outgoing
01	9/20Thu10:10
0900001XXXX	



Page 32

Disaster Message Board Service

Disaster Message Board

The Disaster Message Board lets you use EZweb to register information about your well-being in case of a major disaster. The information you register can be accessed from anywhere in Japan over EZweb or the Internet.

Registering the safety information

- ◆ When a major disaster strikes, you can use your au cellphone to access the “災害用伝言板” (Disaster Message Board) on EZweb and register your current condition, comments, and other information about your well-being.
- ◆ After you register information, it can be sent by mail to family, friends, and other individuals you have registered as a recipient of your Disaster Message Board information.

Checking the safety information

- ◆ Disaster Message Board information can be accessed by inputting the phone number of an individual over EZweb or the Internet.*
 - ※ Disaster Message Board information can be accessed from another type of cellphone, PHS, or PC at <http://dengon.ezweb.ne.jp/>.

Access method



▶▶▶ Top Menu ▶▶▶ 災害用伝言板

(Disaster Message Board)

<http://dengon.ezweb.ne.jp/>



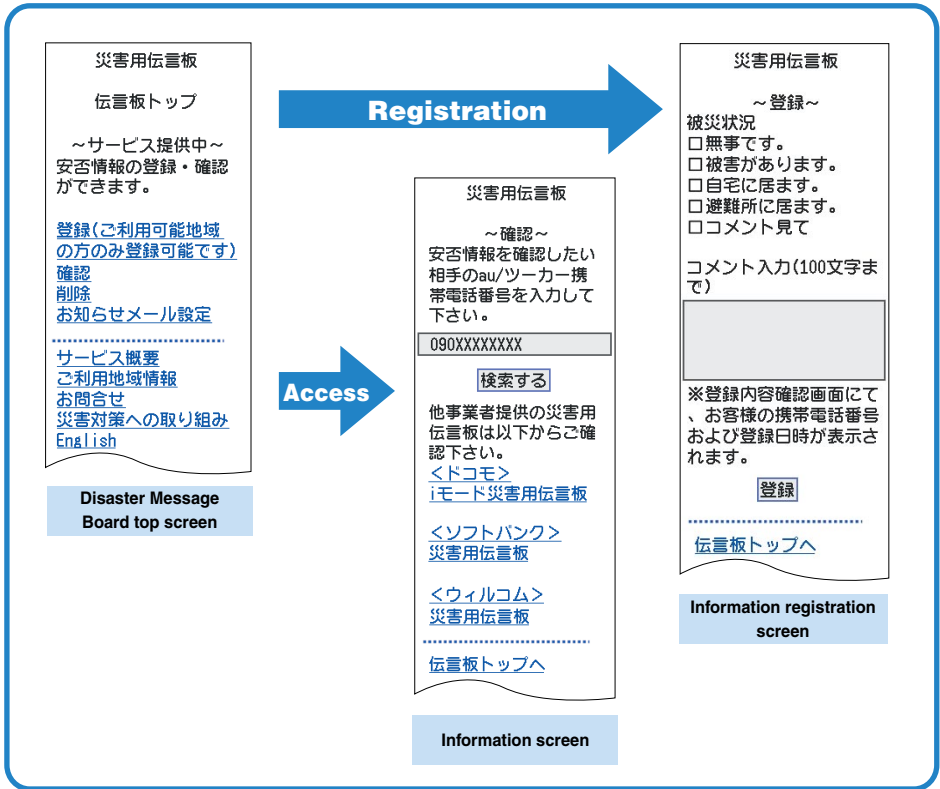

※ Registration contents are retained for up to 72 hours.

※ You can register up to 10 entries per phone number. Registering a new entry while there are already 10 registered entries, automatically overwrites the oldest entry.

※ You can view a Disaster Message Board demonstration at:

☰ → Top Menu → auお客様サポート → 災害用伝言板(デモ版)

(au Customer Support) (Disaster Message Board (Demo))

※ To view the Disaster Message Board in English, select the "English" option on the Disaster Message Board top screen.

Contents

Cellphone Etiquette 1

Mind your manners! 1

Cellphone Basics 2

Features 2

Manner Mode and Easy Voice Memo 3

Checking Power, Signal Strength, and
Battery Level 3

Never use your cellphone while driving! 4

Beware of spam and One-ring Calls! 5

Disaster Message Board Service 6

Contents 8

Ready 10

Checking the Contents of the Package 10

Names of Parts 11

Charging the Battery Pack 12

Turning On Power 14

Initial Values 14

Security Code and Passwords 15

Selecting English as the Display Language
..... 16

Operation Basics 18

Display Indicators 19

Main Menu 20

Viewfinder Position and Self-portrait
Position 22

Using the Direct Camera Menu 23

Basic Operations in Viewfinder Position 24

Initializing E-mail and EZweb 25

Looking Up Your Current Phone Number
and E-mail Address 26

Changing Your E-mail Address 27

Phone Call 29

Making a Call 29

Making an International Call 30

Answering a Call 31

Redialing (Outgoing Records/Incoming
Records) 32

One-ring Calls 32

Changing the Ring Tone 33

Adjusting the Ring Tone Volume 35

Adjusting the Earpiece Volume during
a Call 36

Turning On Manner Mode 36

Turning On Easy Voice Memo 37

Playing an Easy Voice Memo 38

Inputting Characters 39

Inputting an E-mail Address 40

Inputting Pictographs and Useful Sentences
..... 41

Address Book 43

Registering an Address Book 43

Editing an Address Book Record 45

Adding Outgoing or Incoming Record Data
to the Address Book 46

Dialing from the Address Book 47

Pair Function 48

Registering a Pair Partner 48

Making a Phone Call or Sending Mail to a
Pair Partner 49

Mail 50

Using E-mail 50

Using C-mail 51

Creating and Sending E-mail Messages ... 52

Reading Received E-mail Messages 54

Reading an E-mail Message with an
Attached Photo 55

Replying to a Received E-mail Message ... 56

Avoiding Spam 57

Creating and Sending C-mail Messages ... 58

Reading Received C-mail Messages 59

Camera	60	Troubleshooting	91
Using the Camera	60	If you lose your W53CA	92
Shooting a Photo	62		
Shooting Photos in Viewfinder Position	63	Index	95
Viewing Photos	65		
Attaching a Photo to an E-mail Message ..	66		
EZweb	67		
Using EZweb	67		
Displaying the EZ Top Menu	68		
Bookmarking Sites You Frequently Access	69		
Viewing a Bookmarked Site	70		
Checking Charges	70		
Downloading Chaku-Uta®/ Chaku-Uta-Full®	71		
EZ Navi	72		
EZ Navi Features	72		
Simple Mode	74		
Entering Simple Mode	74		
Exiting Simple Mode	75		
Using the Simple Mode Main Menu	76		
Adding Data to the Address Book in Simple Mode	77		
Using the Address Book in Simple Mode	79		
Creating and Sending E-mail Messages in Simple Mode	80		
Shooting a Photo in Simple Mode	83		
Viewing Photos in Simple Mode	84		
Teens Mode	86		
Using Teens Mode	86		
Turning on Teens Mode	87		
Other Functions	88		
Security Setup Features	88		
Extension Mode	89		

Ready

Before using the W53CA, check the contents of the package comes with your W53CA. You should also familiarize yourself with basic operations, like how to charge the battery, how to turn the power on, etc.



Checking the Contents of the Package

● W53CA

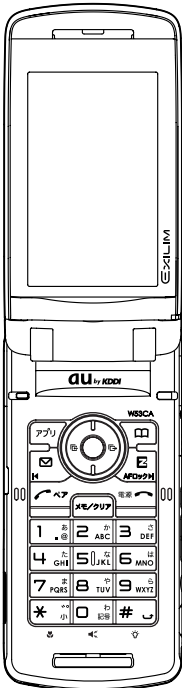

● Battery pack (52CAUAA)

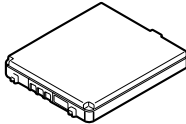

● Desktop holder (53CAPUA)

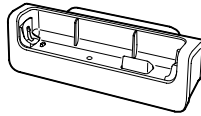

● Casio round-type earphone jack conversion adaptor 03 (03CAQNA)



● Casio USB cable 01 (01CAHUA)

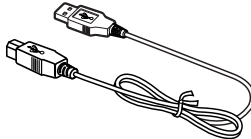

● SONY MDR-E0931 (sample)

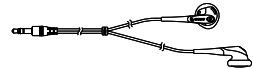

● CD-ROM



- Warranty (Japanese)
- Operating Precautions (Japanese)
- Osaifu-Keitai® Basic Manual (Japanese)
- LISMO Installation Guide (Japanese)
- Basic Manual (Japanese)

- Global Expert Owner's Guide (Japanese)
- Promotional Fliers (Japanese)
- Instruction Manual (Japanese)



Info

- The microSD™ memory card is not included.
- An AC adaptor is not included. It is up to you to purchase a common AC adaptor 01 (option).

Names of Parts

Front

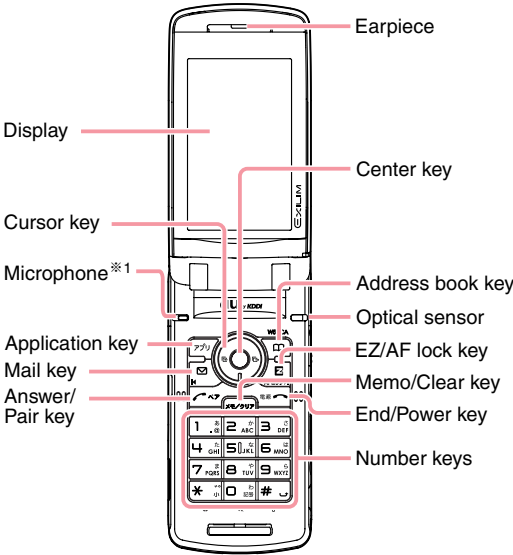

Back

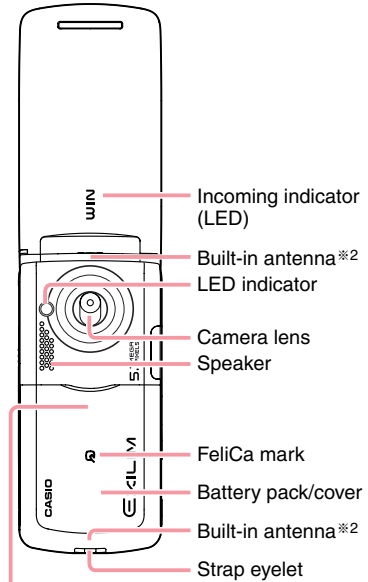

※1 During a call, do not cover the microphone with your hands or your chin. The microphone (placed on W53CA shown above) allows you to talk over your W53CA in Viewfinder position.

※2 Take care to avoid covering the built-in antenna with your hand when using the phone, using EZweb, and when accessing GPS information.

au IC-Card[※]

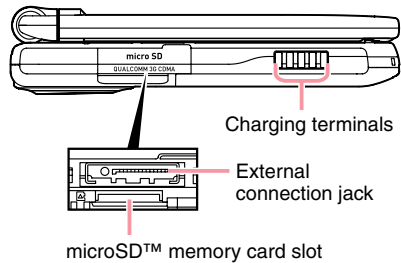
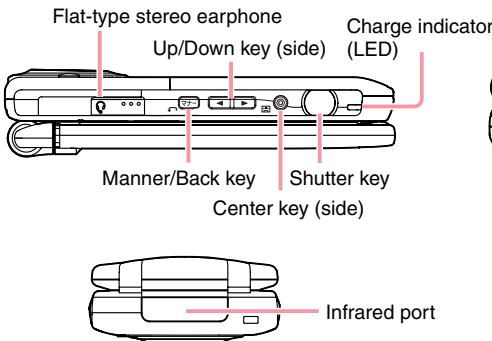

※Do not take out this card if not necessary as your number is recorded on it.

Side



Charging the Battery Pack

The battery pack that comes with the phone is not fully charged when you purchase it. Be sure to charge the battery pack before using the W53CA for the first time. Charging takes about 140 minutes.

You should recharge the battery pack whenever the battery level icon shows  or .

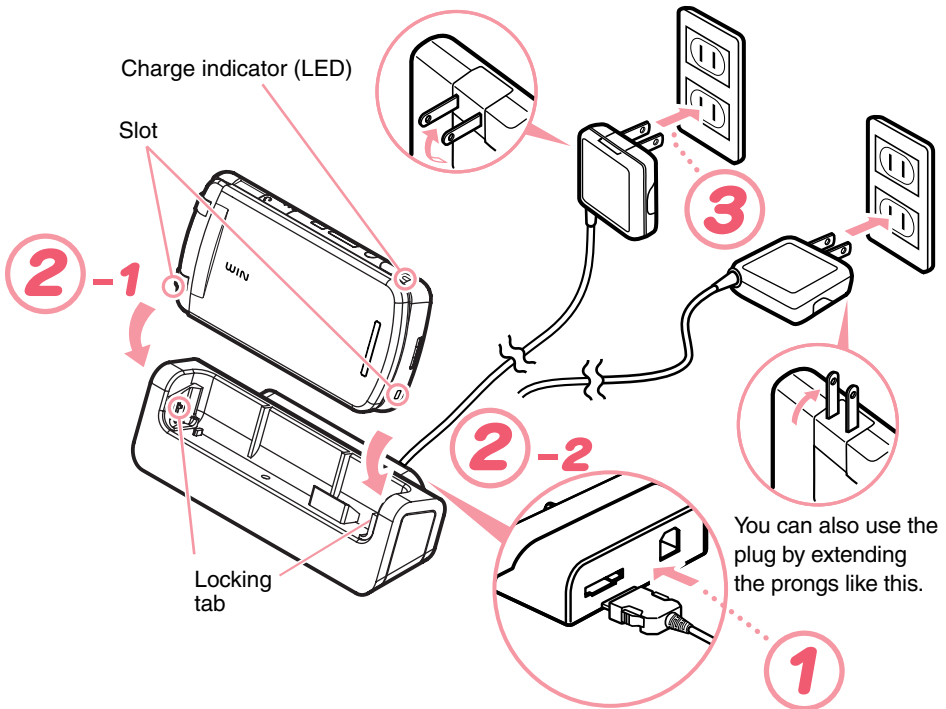

Check the shape of connectors before connecting, and ensure that you plug them in as far as they will go.

CAUTION

- ◎ You must purchase a common AC adaptor 01 (option) for charging. Note that the configuration of the AC adaptor may be different from that shown in the illustration above.
- ◎ Orient the connector of the common AC adaptor 01 (option) so it is parallel to the W53CA or desktop holder connector terminal when you connect them.



1 Connect the common AC adaptor 01 (option) to the desktop holder.

Check the shape of the connectors to ensure they are aligned correctly before you connect.

Trying to force a connection may damage the connectors.

2 Insert the W53CA into the desktop holder.

3 Fold out the power plug of the common AC adaptor 01 (option), and then plug it into a 100V AC power outlet.

This will cause the W53CA charge LED indicator to light red, and  (charging battery icon) to display. When charging is completed, the battery level icon will show  and the charge LED indicator will go out.

When charging the battery with your W53CA in Viewfinder position, check the charging battery icon shown on the screen.

If "MEDIA STAND" is displayed, normal illumination continues.

To remove the W53CA from the desktop holder, holding the holder by hand and remove W53CA.

※ You can connect the common AC adaptor 01 (option) to the W53CA directly to charge the battery pack.

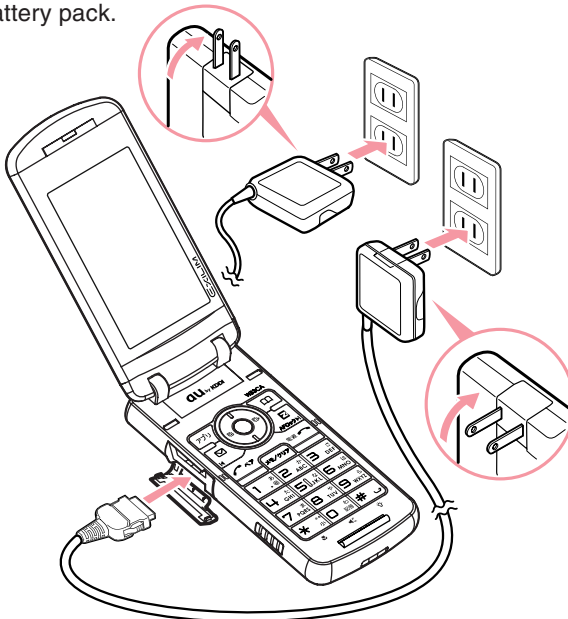

Check the shape of the connector ends to ensure they are aligned correctly (shown above) when connecting.

Turning On Power

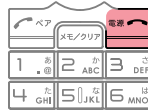

1

Hold down  for at least 1.5 seconds.







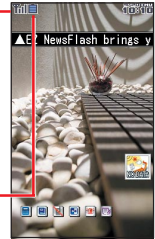

The message “hang on a sec?” will appear on the display for a short while, followed by the standby screen.

Icon					
Signal Strength	Strong	Medium	Weak	Very Weak	Out of Range

- Communication is not possible while the signal strength icon is  (Out of Range).
- Communication may not be possible while the signal strength icon is  (Very Weak).



Standby screen

Icon							
Battery Level	Fully Charged	High	Medium	Low	Fully Discharged	Extension Mode*	Charging

- The battery level icon  (Fully Charged) only shows during charging.

※ Using Extension Mode

Using the Extension Mode, W53CA automatically shuts down the radio wave after issuing the Low Battery Alert. This is quite a useful function that you can still check outgoing/incoming records, content of e-mail, address book, schedule and so on when necessary. In this case, you can only use the functions which needs no radio wave.

▶ Page 89

■ Turning off power

Hold down  for at least 1.5 seconds.

Initial Values

The following are the initial settings of the phone.

Lock No.	1234	Font Size	Add Book Char	Middle
Teens Lock No.	1234		Input	Middle
Caller ID	ON		Mail Char	Middle
DispRcvngCaller	ON		EZweb Char	Small
Profile	Blank		Data Folder Char	Middle
			Text Memo Char	Middle

Security Code and Passwords

The W53CA lets you use the numbers and passwords described below. Be sure to take steps so you do not forget your numbers and passwords. You will need them to perform various operations and to access subscription services.

Security Code

Usage Examples	① For remote operation of the Answering Service (Voice Mail) and Call Transfer from a standard phone
	② For inquiries, applications, and service modifications using au Customer Service Center voice guidance, au website, and EZweb
	③ For changing e-mail settings
Initial Value	4-digit number you entered on your subscription contract

Lock No.

Usage Examples	For modifying various phone settings
Initial Value	1234

Teens Lock No.

Usage Examples	For modifying various phone settings in Teens Mode
Initial Value	1234

EZ Password

Usage Examples	For entering and canceling subscriptions for EZweb fee-based content
Initial Value	4-digit number you entered on your subscription contract



Premium EZ Password

Usage Examples	① For entering and canceling subscriptions for EZweb fee-based content paid for using “まとめてau支払い” (au Collective Payment Service)
	② For purchasing products from EZweb sites that use “まとめてau支払い” (au Collective Payment Service)
Initial Value	4-digit number you entered on your subscription contract

Selecting English as the Display Language

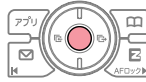
1 While the standby screen is displayed, press .



2 Use  to select “機能設定” (Settings), and then press .

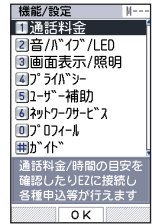

3 Press  (画面表示/照明) (Screen Setup/Display Lighting).

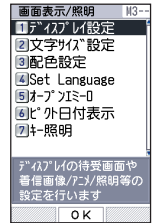

4 Press (Set Language).



5 Press (English).

This selects English as the display language.



CAUTION

Even if English is selected as the display language, schedule and other dates are displayed in the format year/month/day. Folder names inside of the Data Folder are also displayed in year/month/day format.

Operation Basics

■ Key functions

- ◀ • Displays incoming records.
• Returns to the previous menu screen.
• Selects an item.
- ▼ • Displays the standby shortcut icon.
• Selects news flash telop/window.
• Selects an item.
- アプリ • Displays the EZ apps menu.
- ✉ • E-mail
• C-mail (hold down for about one second)
- ☎ • Dials/answers a phone call.
• Displays the Pair Function.
- メモ • Memo
• Toggles Easy Voice Memo on and off (hold down for about one second).
• Deletes a character.
• Returns to the previous menu screen.

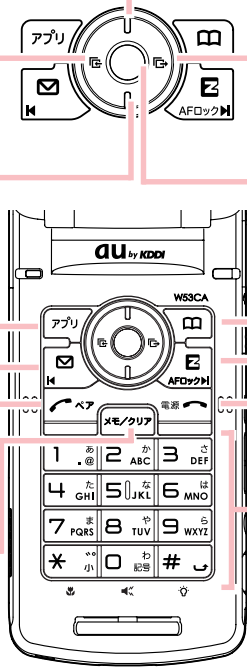

- ▲ • Selects news flash telop/window.
• Displays the standby shortcut icon.
• Selects an item.
- ▶ • Displays outgoing records.
• Scrolls forward one menu screen.
• Selects an item.
- • Displays the main menu.
• Applies an item.
- ☎ • Displays the address book.
• Creates a new address book (hold down for about one second).
- EZ • Displays the EZ menu.
- 電源 • Toggles power on and off (hold down for at least 1.5 seconds).
• Hangs up.
• Terminates a function.
• Returns to the standby screen.
- ☎ ~ ✉ ~ * ~ # ~ • Inputs phone number.
• Inputs text character.

■ Side key functions → “Viewfinder Position and Self-portrait Position” (Page 22)

- マナー • Toggles Manner Mode on and off (hold down for about one second).
- ◎ • Applies an item.

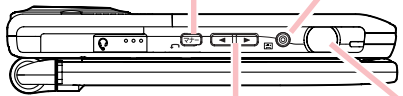

- ◀ ▶ • Selects news flash telop/window. ※
• Displays the standby shortcut icon. ※
• Selects an item. ※
• Page scroll at browser display
 - • Displays “Direct Camera Menu”. ※
• Starts photo (hold down for about one second).
• Shutter when shooting photo
- ※ Can be operated in Viewfinder position only.

Info

- If you lose track of where you are or if you make a mistake:
Press **メモ/リターン** to scroll back to the previous screen.
Press **電源** to return to the standby screen.
- When **ガイド** is in the lower right corner of the photo screen etc., pressing **☎** will display key help.
- Holding down **●/◎** for about one second toggles side key's disabling feature on and off while W53CA is folded. To cancel the side key's disabling feature, follow the above procedure with W53CA unfolded.

Display Indicators

The following explains the main icons that appear on the standby screen.



1		Signal strength
2		Battery level
3		The microSD™ memory card (commercial item) is inserted into the cellphone.
4		Call or EZweb browsing in progress
5		EZ apps (BREW®)/Hello Messenger/PC Site Viewer on
6		Unread mail
7		au Music Player/SD-Audio Player on
8		Key guidance on the EZweb screen (while browsing) or the EZ Channel-Plus program screen (while playback), etc.
9		Current time* The date and time are set automatically.
10		FeliCa Lock on
11		Selects the user defined icons such as calculator, Mobile Dictionary, Emission Off Mode, Mode Settings, Extension Mode, and Note Pad 01 “カシオからのご案内” (information from CASIO), etc. by pressing and .
12		Easy Voice Memo on
13		Manner Mode on
14		Ring tone off
15		Vibrator on
16		EZ Channel-Plus is in use.
17	—	News flash telop
18	—	News flash window

※ A hyphen (-) may appear in place of the current date.

■ Key symbols used in this manual

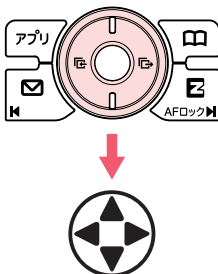



The cursor key described in this manual using the key symbols shown below.

or key:

or key:

, , , or key:

Main Menu

Pressing  while the standby screen is displayed displays the main menu. Use  to select the icon, and then press  (OK) to access the function associated with the icon.

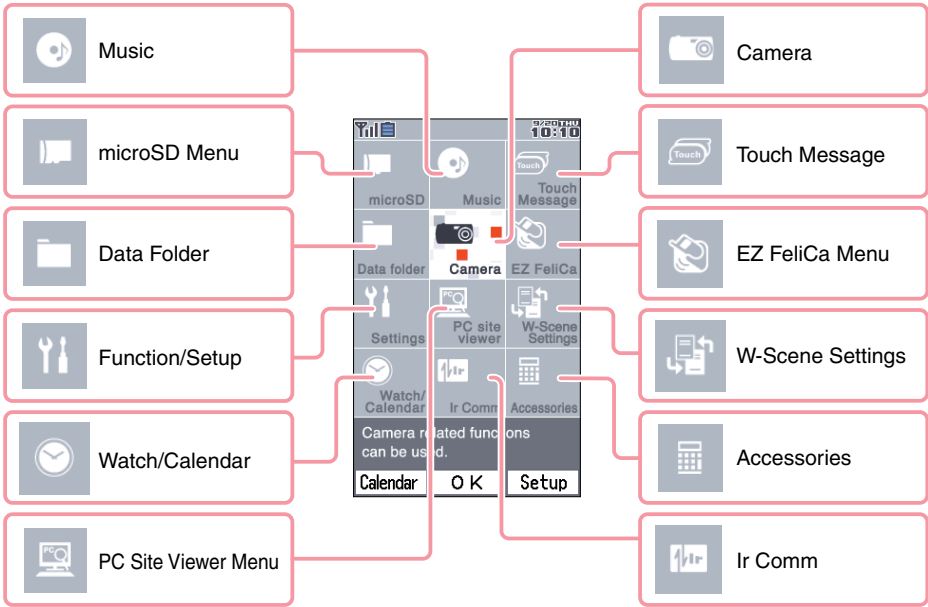

Using the Main Menu

Example: To display the setting screen from the main menu.

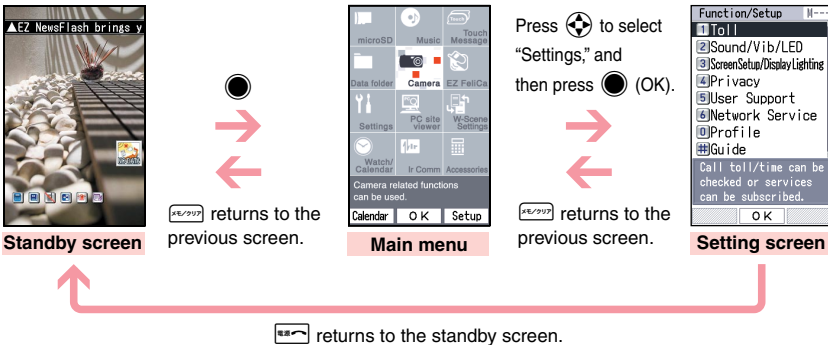

Using Soft Keys

Soft keys are the keys you use to execute the functions along with the bottom of the screen. The table below explains how to assign the soft keys to the on-screen functions. Note that the function of each soft key depends on the currently displayed screen.

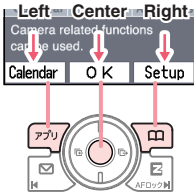

Left soft key		Executes the function on the left.
Center soft key		Executes the function on the center.
Right soft key		Executes the function on the right.

Using Menus

Pressing the soft key that corresponds to the “Menu” at the bottom of the display will display a menu of various operations related to the function you are currently using.

Example: To open the photo monitor menu screen from photo monitor screen.

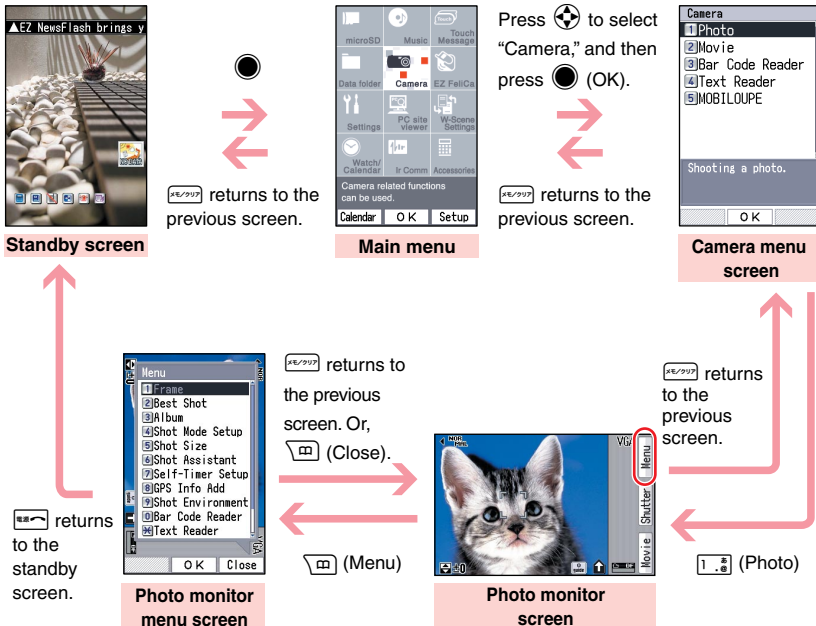

Viewfinder Position and Self-portrait Position

You can execute the operations with your W53CA open, set in Viewfinder position or Self-portrait position.

8 CAUTION

- Rotate your W53CA display in the direction as illustrated below (within 180 degrees from the normal position). Gently rotate your W53CA display. Otherwise, you may damage your W53CA.
- During rotating (motion **2-1**), do not use your W53CA or force to give open-close motion. It may also cause damage.

1 Open your W53CA display to stand straight up.

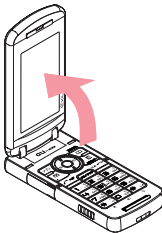

2 Gently rotate the display 180 degrees clockwise.

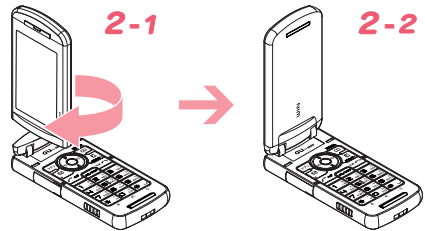

■ When you set your W53CA in Viewfinder position

3 Close your W53CA so as to make your W53CA display facing toward you.

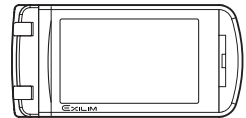

● Viewfinder position

Viewfinder position refers to the position with your W53CA closed and its display turned over. In Viewfinder position, you can use side keys (マナー, ←, →, Ⓞ, ○) to operate your W53CA.

You can also take photos using W53CA as a Viewfinder (digital camera-like).

■ When you set your W53CA in Self-portrait position

3 Turn over your W53CA so as to make camera lens facing toward you.

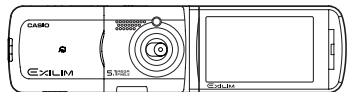



● Self-portrait position

You can take your self-portrait photo easily with this position.

Info

Changing to the Viewfinder position while the standby screen or main menu is displayed will cause the “Direct Camera Menu” to appear for about 30 seconds. For details, see “Using the Direct Camera Menu” (page 23).

Using the Direct Camera Menu

Changing to the Viewfinder position while the standby screen is displayed will cause the “Direct Camera Menu” to appear for about 30 seconds. You can press  to shoot a snapshot or  to display an album.

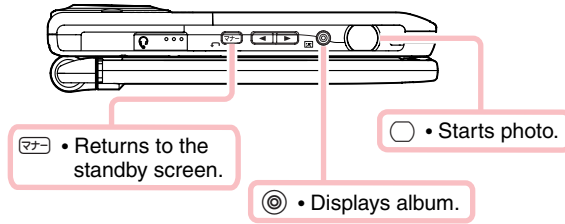
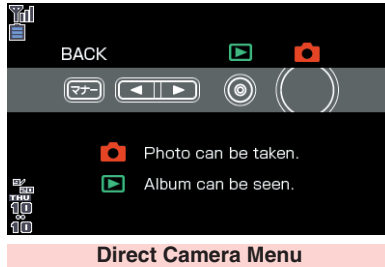

Info

- ◎ You can also display the Direct Camera Menu by pressing  while the standby screen is displayed in the Viewfinder position.
- ◎ Displaying the main menu and then changing to the Viewfinder position while the phone is unfolded will also display the Direct Camera Menu.

Basic Operations in Viewfinder Position

If you want to use the side keys (マナー, ◀, ▶, ◎, ○) to control another application in the Viewfinder position, start up the application before changing to the Viewfinder position.

Use ◀ and ▶ in place of ⬆, and ◎ in place of ●. To scroll back to the previous screen, press マナー.

■ Key operations in Viewfinder position

Key	Description
マナー	<ul style="list-style-type: none"> • Displays the Manner menu. • Toggles Manner Mode on and off (hold down for about one second). • Set the ring tone mute and stop the vibrator when there is an incoming call. • Hangs up (hold down for about one second). • Returns to the previous screen. • Returns to the standby screen (hold down for about one second).
◀ ▶	<ul style="list-style-type: none"> • Selects EZ News Flash telop/window or standby shortcut while the standby screen is displayed. • Moves the cursor on the screen (instead of ⬆ (Up/Down key)).
◎	<ul style="list-style-type: none"> • Disables side keys (hold down for about one second). • Answers the call when there is an incoming call (hold down for about one second). • Executes the function on the center part of the bottom of the screen (instead of ● (Center key)).
○	<ul style="list-style-type: none"> • Displays the Direct Camera Menu. • Activates photo function (hold down for about one second). • Uses as shutter key when you shoot photos.

Info

- ◎ In Viewfinder position, you can only execute the operations using side keys. When needed, you can execute other operations with your cellphone open.
- ◎ You can make or answer a call in Viewfinder position.
- ◎ During a call in Viewfinder position, check the earpiece position to hear the caller's voice properly. During a call or recording a call, the image you see on the screen is upside down.
- ◎ During a call, it is recommended to use your cellphone opened.
- ◎ In this manual, operation procedures are usually for the normal position (with display facing inward toward the keypad). For operations in Viewfinder or self-portrait position (with display facing outward), the position you can use is clearly mentioned.

Initializing E-mail and EZweb

An EZweb subscription is required to use e-mail, EZweb or other EZ services. If you did not subscribe when you purchased your phone, contact your nearest au shop or the au Customer Service Center.

※ You will be assigned an e-mail address automatically when you perform the EZweb initialization procedure.

1 While the standby screen is displayed, press .

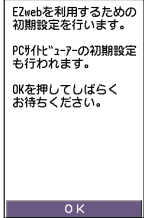
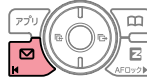

2 Press .

Wait until the phone connects to the server for initialization.

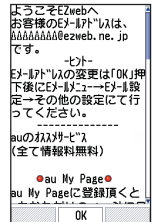
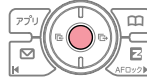

3 After your automatically assigned e-mail address appears, press .

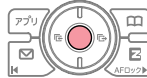

Info



Pressing  or  also allows you to make initial settings.

Looking Up Your Current Phone Number and E-mail Address

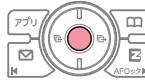

1 While the standby screen is displayed, press .



2 Use  to select “Settings,” and then press  (OK).

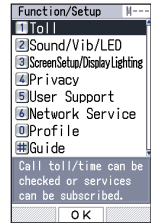

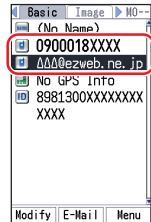

3 Press  (Profile).

Your current phone number and e-mail address appear.



Info

You can also look up your phone number and e-mail address by pressing , and then  while the standby screen is displayed.

Changing Your E-mail Address

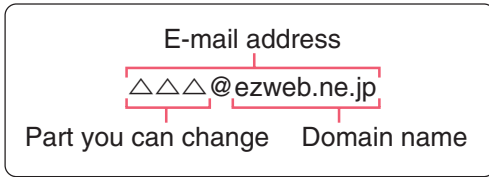

1 While the standby screen is displayed, press .

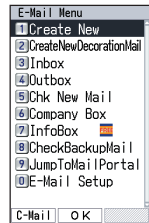
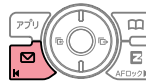

2 Press (E-Mail Setup).



3 Press (Other Setup).

When the EZweb connection confirmation screen appears, press (Yes).

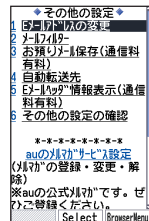

4 Press (Eメールアドレスの変更) (Change E-mail Address).

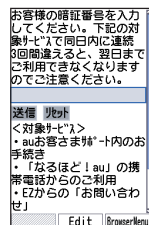

5 Enter your Security Code, press ● (OK), use ▲▼ to select “送信” (Send), and then press ● (Select). Use ▲▼ to select “承諾する” (Accept), and then press ● (Select).



Eメールを変更します。
ご希望のEメールを入力してください。

※入力時の注意※
1. 半角英数小文字で「@ezweb.ne.jp」より左側のみを入力ください。
2. Eメールには半角英数30文字まで入力可能です。

記号は「,」「,」「,」が使用可能です。「,」は最初には利用できません。最初に数字の「0」を使用することはできません。

Back | BrowserMenu

6 Use ▲▼ to select the text box, and then press ● (Edit). Enter the e-mail address you want, and then press ● (OK).



2. Eメールには半角英数30文字まで入力可能です

記号は「,」「,」「,」が使用可能です。「,」は最初には利用できません。最初に数字の「0」を使用することはできません。

△△△△△△
@ezweb.ne.jp

送信 リスト

◀ 前のページへ

Select | BrowserMenu

To input an e-mail address
→ “Inputting an E-mail Address” (page 40)

7 Use ▲▼ to select “送信” (Send), and then press ● (Select).

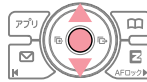

新しいEメールには
△△△△△△@ezweb.ne.jp
です。
よろしいですか？

OK キャンセル

Select | BrowserMenu

The e-mail address confirmation screen appears.

8 Press ▲▼ to select “OK,” and then press ● (Select).

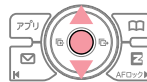

The message “Update is complete.” appears to indicate that your e-mail address has been changed.



Info

- ◎ Your Security Code is the 4-digit number you entered on your subscription contract. If the wrong Security Code is entered three times a day, the setting operation will be disabled until the following day.
- ◎ If your e-mail address won't change in step 7:
The new e-mail address you entered may be registered by someone else already. Try entering a different address.

Phone Call

Making a Call

1

While the standby screen is displayed, use the number keys ( to ) of the keypad to enter the phone number you want to call.

When calling a standard phone, you need to enter the area code.

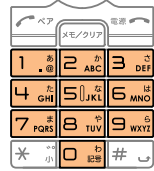

2

Press .

After you finish a call, press  to hang up.

※ The caller always hears your voice even when you cover the microphone with your hands.

Send Methods

Displayed when you press  (Call) in step 2.

Call : Your phone number is provided to the party you are calling in accordance with the caller ID setting of your phone.

184 Add : Your phone number is not provided to the party you are calling.

186 Add : Your phone number is provided to the party you are calling.



Making an International Call

■ au International Call Service

Available without any additional application

Ex: To call 212-123-△△△△ in the USA

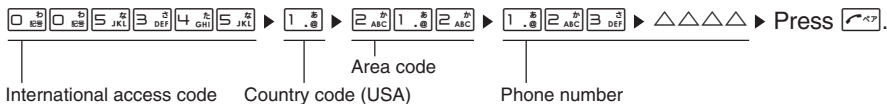

- Calling charges for this service are added to monthly mobile phone calling charges and billed together.
- Please check the Country code at the au Customer Service Center.
- For charges, please refer to the au MOBILE PHONE SERVICE GUIDE or contact the au Customer Service Center.

■ 001 KOKUSAI MOBILE TALK

Application required.

For inquiries, please contact the KDDI Customer Service Center.

0077-7160 (toll-free; open 9:00 to 20:00 on everyday including weekends and national holiday)

Ex: To call 212-123-△△△△ in the USA

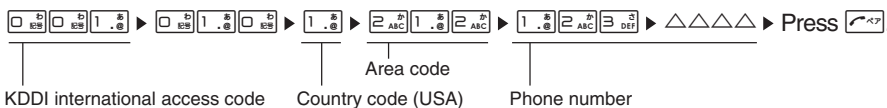

- Charges for 001 KOKUSAI MOBILE TALK are charged separately from monthly au telephone charges.
- Please check the Country code at the au Customer Service Center.
- For charges, please refer to the au MOBILE PHONE SERVICE GUIDE or contact the au Customer Service Center.

Answering a Call

1

Press  to answer an incoming call.

After you finish a call, press  to hang up.



Info

Display for Incoming Calls



If the caller's name is in your address book, it appears on the display. If not, only the caller's phone number is displayed.

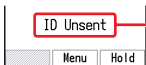

A message appears when the phone number of the caller is not provided for some reason.

ID Unsent : The caller's phone refused to send its phone number.

Pay Phone : The call is from a pay phone.

Not Support : The call is from a phone that does not support caller ID.

Missed Call Notification

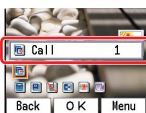



The message "Call X" appears on the display if you did not answer one or more calls. Press  (OK) to check incoming records (caller phone number, etc.).

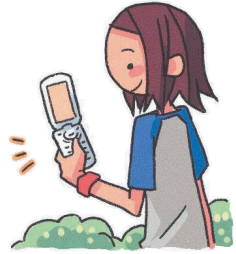

To redial a number

→ "Redialing (Outgoing Records/Incoming Records)"
(page 32)

Redialing (Outgoing Records/ Incoming Records)





1 While the standby screen is displayed, press .

-  : Displays outgoing records.
-  : Displays incoming records.



Incoming	Outgoing
01	9/20Thu10:07
	Chris Tait
02	9/19Wed 9:32
	Mark Brown
03	9/18Tue17:20
	030001XXXX
04	9/18Tue12:20
	Betty Mason
05	9/17Mon18:08
	Play VM

2 Use  to select the record whose number you want to dial, and then press .



Info

The phone stores up to 50 records each for the outgoing records and incoming records. When a record is created while there are already 50 records in memory, the oldest current record is deleted automatically to make room for the new one.



One-ring Calls

What is a “One-ring Call”?

A “One-ring Call” is an incoming call that rings your phone only once, which aims it to be stored in your incoming records. If you redial the number shown in your incoming records, often you are connected to a dating service or some other service that may bills you very high charges. Always keep in mind that it is a good idea to avoid calling back unfamiliar numbers.

One-ring Call indicator

Incoming	Outgoing
01	9/20Thu10:07
	0900001XXXX
02	9/20Thu 9:40
	Bob Smith

The  icon indicates an incoming call you did not answer. The  icon indicates an incoming call that rang for four seconds or less. These calls may be One-ring Calls with high possibility.

Changing the Ring Tone



1 While the standby screen is displayed, press **OK**.

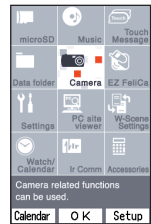
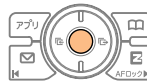

2 Use **Up** to select “Settings,” and then press **OK** (OK).

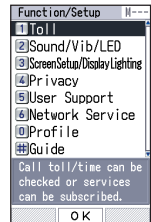

3 Press **2** (Sound/Vib/LED).

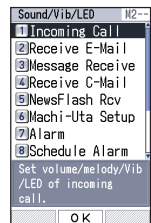

4 Press **1** (Incoming Call).

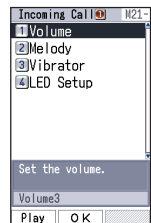

5 Press **2** (Melody).



6 Press **1** (Fixed Sound).

To hear the currently selected ring tone, press **1** (Check).

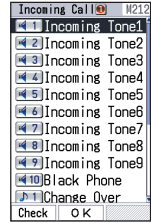

7 Use **▲** to select the ring tone you want, and then press **●** (OK).

The ring tone is set.



Info

- The initial setting is “Incoming Tone1.”
- You can also download a “Chaku-Uta®” from the Internet and use it for your ring tone.
→ “Downloading Chaku-Uta®/Chaku-Uta-Full®” (page 71)

Adjusting the Ring Tone Volume



To adjust the ring tone volume, perform steps 1 through 3 under “Changing the Ring Tone” (page 33), and then continue with the following steps.

1 Press **1** (Incoming Call).

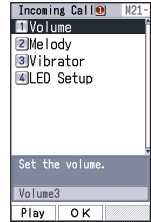

2 Press **1** (Volume).

To hear the ring tone at the current volume setting, press **Play** (Play).



3 Use **▲** to adjust the ring tone volume, and then press **●** (OK).



- ▲ : Increases volume.
- ▼ : Decreases volume.

Info

Step-up : Ring tone volume gradually increases.

Step-down: Ring tone volume gradually decreases.

Mute : Ring tone does not sound.



To display the “Step-up” and “Step-down” settings, select volume level 5, and then press ▲.

To display the “Mute” setting, select volume level 1, and then press ▼.

Adjusting the Earpiece Volume during a Call



1 During a call, use  to adjust the volume.

-  : Increases volume.
-  : Decreases volume.

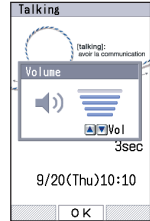

You can adjust the earpiece volume (level 1-6).

When you set the maximum volume,  is displayed on the screen.

Turning On Manner Mode

While Manner Mode is set to on, the phone alerts you to incoming calls by vibrating.



1 While the standby screen is displayed, hold down  for about one second.

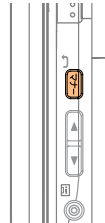

This turns on Manner Mode, the  icon appears on the display while Manner Mode is turned on.



Turning on Manner Mode also turns on Easy Voice Memo, which is indicated by  on the display. While Manner Mode is set to on, the phone vibrates without sounding its ring tone.

To turn off Manner Mode, hold down  for about one second.

Info

While the standby screen is displayed, you can press  to select "ON" and then select the Manner Mode type. Holding down  for about one second while the standby screen is displayed will enable the Manner Mode type you select.

Turning On Easy Voice Memo



1

While the standby screen is displayed, hold down  for about one second.

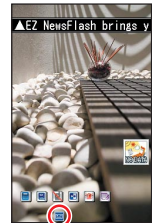

This turns on Easy Voice Memo, the  icon appears on the display while Easy Voice Memo is turned on.

You can use Easy Voice Memos (up to 4 memos), and each memo can contain up to 20 seconds recording time.

If a new Easy Voice Memo is recorded when there are already four memos in memory, the oldest, unprotected memo that has already been played back is deleted automatically to make room for the new one. Protected Easy Voice Memos are not deleted.

To turn off Easy Voice Memo, hold down  for about one second.

Info

Using the Answering Service (Voice Mail)

The Answering Service (Voice Mail) can be used to answer the phone and take messages when the phone is turned off, or when you are in a location where signal reception is not possible.

Playing an Easy Voice Memo



When there is a recorded Easy Voice Memos

The message “ Call” and “ EasyVoiceMemo” appear on the standby screen.

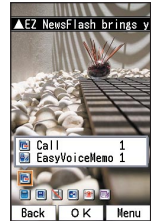

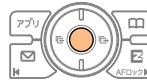

- 1 Select “ Call,” and then press .

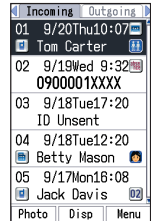

The incoming records list appears.





- 2 Use  to select the record with the  icon, and then press  (Disp).

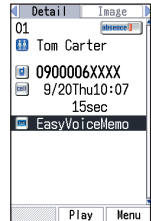

The incoming record detail screen appears.





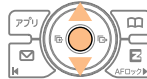





- 3 Use  to select “ EasyVoiceMemo,” and then press .



The Easy Voice Memo plays back.

Info













To delete an Easy Voice Memo, press     while the standby screen is displayed. Select the Easy Voice Memo you want to delete, press  (Menu), and then  (Delete). Next press  (Delete One), and then press  (Yes).

Inputting Characters

Input characters using keypad keys  through , and .

The table below shows the characters each key cycles through when you press it.



Key	Number of Presses								
	1	2	3	4	5	6	7	8	9
 1 .@	.	@	-	_	/	:	~	1	.
 2 ABC	a	b	c	A	B	C	2		
 3 DEF	d	e	f	D	E	F	3		
 4 GHI	g	h	i	G	H	I	4		
 5 JKL	j	k	l	J	K	L	5		
 6 MNO	m	n	o	M	N	O	6		
 7 PQRS	p	q	r	s	P	Q	R	S	7
 8 TUV	t	u	v	T	U	V	8		
 9 WXYZ	w	x	y	z	W	X	Y	Z	9
 0 BSR	0 . @ - _ / : ! ? ~ () * # + , ^ ; < = > \$ ¥ % & [] ' ` { } " Space								
 * **	Toggles between upper case and lower case (Example: a ⇔ A). Inputs a comma (,), period (.), hyphen (-), tilde (~), exclamation point (!), question mark (?), or space when the cursor is at a non upper/lower case character.								
 # ↵	Returns to the previous character.								
 ↶	Undoes the last delete operation.								

- In order to input consecutive characters that are assigned to the same key, press  to move the cursor (highlighted), and then press the same key to input next character.

CAUTION

Allowable Characters in Your E-mail Address

Your e-mail address (the part at the left of “@”) can contain up to 30 characters, including single-byte English lower case letters, hyphens (-), periods (.) and underbars (_).

A period (.) or a zero (0) cannot be used as the first character.

Characters and symbols that are shaded in the above table cannot be used at the left of “@” in the address format “△△△@ezweb.ne.jp.”

Info

You can input a period (.) or “at” symbol (@) by pressing .

Inputting an E-mail Address



Inputting “mark@ezweb.ne.jp”

In this example, we will input “mark@ezweb.ne.jp” for “<E-Mail Add1>.” To input “<E-Mail Add1>,” perform steps 1 through 6 under “Registering an Address Book” (page 43), and then perform the following steps.

1 Input “mark.”

- To input “m”: Press once.
- To input “a”: Press once.
- To input “r”: Press three times.
- To input “k”: Press twice.



2 Press (Menu).

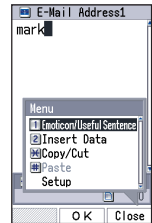

3 Press (Emoticon/Useful Sentence), and then (Useful Sentence).



4 Use to select “@ezweb.ne.jp,” and then press (OK).

“mark@ezweb.ne.jp” is inputted.
You could also input “@ezweb.ne.jp” by pressing .

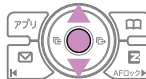

Inputting Pictographs and Useful Sentences



The following procedure shows how to input pictographs and useful sentences into the body text when creating a new e-mail message.

1 Press **アプリ** (Char), and then **は MNO** (Pictograph).

You can also select a pictograph by pressing **#**.

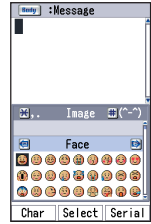

2 Use **⬆** to select the pictograph you want, and then press **●** (Select).

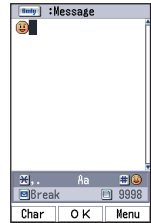
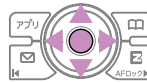

Use **⬅** and **➡** to scroll through the various categories of pictographs. To input consecutive pictographs, press **⏪** (Serial).

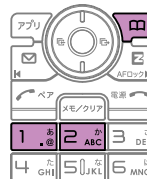

3 Press **☰** (Menu), **1 あ** (Emoticon/Useful Sentence), and then **か ABC** (Useful Sentence).



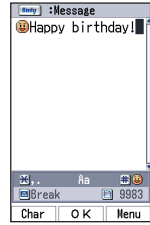
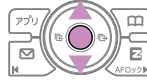

4

Use  to select the useful sentence you want, and then press  (OK).



Here we will select “Happy birthday!”

You can also input “Happy birthday!” by pressing  .



Address Book



Registering an Address Book

- 1 While the standby screen is displayed, hold down  for about one second.





- 2 Select “ <Name>,” and then press  (Edit).



- 3 Enter the name, and then press  (OK).

The  <Reading> is generated automatically when you enter a name.
To input text
→ “Inputting Characters” (page 39)



- 4 Use  to select “ <Phone Number1>,” and then press  (Edit).



5

Enter the phone number, and then press **OK**.

When entering the number of a standard phone, be sure to include the area code.



6

Use **Up/Down** to select “**E-Mail Add1**,” and then press **Edit**.

If you do not want to enter an e-mail address, jump to step 8.

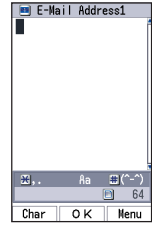

7

Enter the e-mail address, and then press **OK**.

To input an e-mail address → “Inputting an E-mail Address” (page 40)



8

Press **Reg**.





Info

- The Address Book can contain up to 1,000 records.
- Address book records are numbered from 000 through 999. A new record is automatically assigned to the lowest available unused record number.
- An address book record can also contain a scene, website URL, street address, birthday, and other personal information.
- To delete an address book record, press **Reg** while the standby screen is displayed. Use **Up/Down** to select the address book you want to delete, press **Menu**, and then **Delete**. Next press **Delete One**, and then press **Yes**.



Editing an Address Book Record



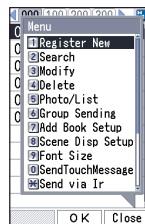

Example: To edit the phone number of “Tom Carter”

1 While the standby screen is displayed, press , use  to select the record you want to edit, and then press  (Menu).





2 Press  (Modify), and then  (Overwrite).



3 Use  to select “ 0900006XXXX,” and then press  (Edit).



4 Make the changes you want, press  (OK), and then  (Reg).

To delete characters, press .



Adding Outgoing or Incoming Record Data to the Address Book



1 While the standby screen is displayed, press , use to select the phone number you want to save, and then press (Menu).

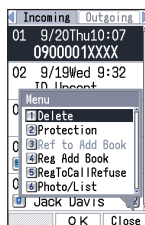

- : Displays outgoing records.
- : Displays incoming records.

2 Press (Reg Add Book).



3 Press (Reg New).

To enter the name, use the procedure starting from step 2 under “Registering an Address Book” (page 43).

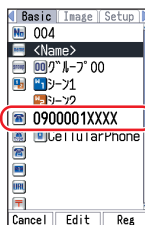

Pair Function



You can save up to five phone numbers (like frequently used ones from the address book). You can make calls or send mails to these saved numbers (called Pair Partners) more easily.

Registering a Pair Partner

1 While the standby screen is displayed, press .

If the Pair Partner is not registered, the confirmation screen appears. Press (OK). Use to select the 1 through 5 tab where you want to register the Pair Partner.

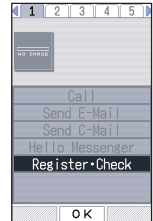

2 Use to select "Register-Check," and then press (OK).

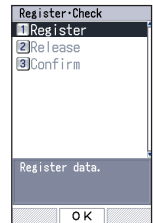

3 Press (Register).



4 Use to select the address book record for the person you want to register as a Pair Partner, and then press (Select).



When there is more than one phone number/e-mail address registered in the address book, the Pair Function phone number/e-mail address selection screen will appear.

5 Press (Reg.).



Making a Phone Call or Sending Mail to a Pair Partner



1 While the standby screen is displayed, press .

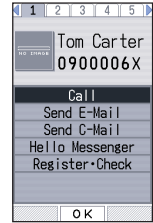

2 Use to select the Pair Partner.



3 Use to select “Call,” and then press (OK).



Sending E-mail: After selecting “Send E-Mail” and then pressing (OK), selecting “Create New” and then pressing (OK) will display a screen for a composing and sending an e-mail message.

Sending C-mail: Selecting “Send C-Mail” and then pressing (OK) will display a screen for a composing and sending a C-mail message.

For the subsequent procedure, see in “Creating and Sending E-mail Messages” (page 52)/“Creating and Sending C-mail Messages” (page 58).

Info

In order to register a person as a Pair Partner, that person’s name, phone number, and other information need to be registered in the address book beforehand. Use the procedure under “Registering an Address Book” (page 43) to create the required record before trying to register a person as a Pair Partner.



Your W53CA supports two types of mail:
e-mail and C-mail.

Using E-mail

To use e-mail, you need to subscribe to an EZweb service. If you did not subscribe when you purchased your phone, contact your nearest au shop or the au Customer Service Center.

In addition to an EZweb subscription, you also need to perform an initialization procedure before you can use e-mail. If you have not performed initialization yet, refer to "Initializing E-mail and EZweb" (page 25).

E-mail makes you possible to exchange mails with a PC and with another cellphone that supports e-mail function.

You can send mail messages that contain up to 5,000 double-byte characters (10,000 single-byte characters), and you can attach photos to e-mail messages.

Page 52

- ※ You can send an e-mail up to five addressees at a time.
- ※ You can send up to 1,000 e-mail messages (each addressee counts as a separate message) per day.
- ※ The sending and receiving operations may take longer when a mail message has data attached.
- ※ You will be charged for packet communication fees in accordance with the amount of data involved when you send or receive e-mail.

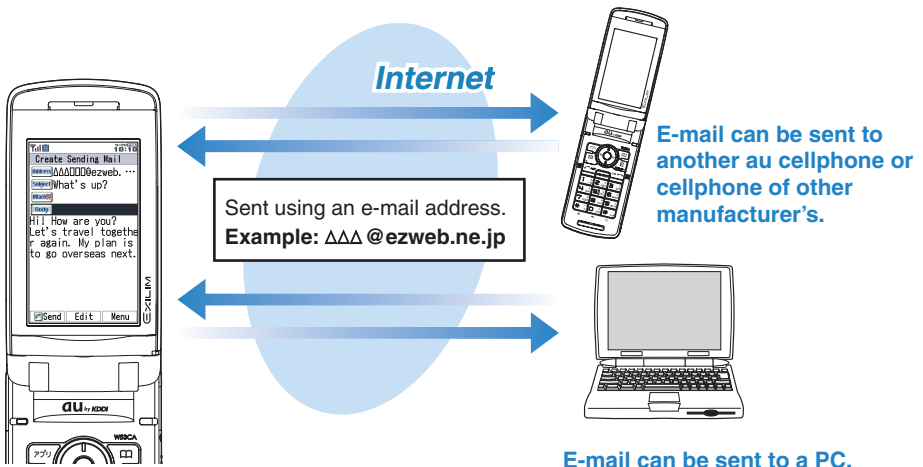

Using C-mail

C-mail lets you exchange text messages that contain up to 50 double-byte characters (100 single-byte characters) with another au cellphone that supports C-mails.

▶ Page 58

※ You will be charged each time you send C-mail.

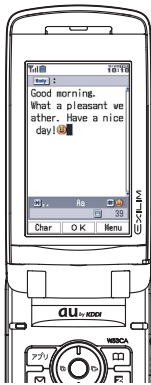

C-mail Center

Sent using a phone number.
Example: 090-0001-XXXX

Received using a phone number.
Example: 090-0002-XXXX

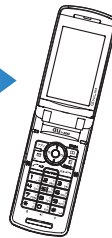



C-mail can be sent to another au cellphone.

About C-mail Safety Block



- C-mail Safety Block blocks C-mails that contain accessing URLs (<http://△△△>, <https://△△△>) or phone numbers in its body text. C-mail Safety Block is set to on by default. If you want to receive C-mails that contain accessing URLs or phone numbers in their body texts, you can disable this function to receive such C-mails.

Creating and Sending E-mail Messages



1 While the standby screen is displayed, press , and then press  (Create New).





2 Select , and then press  (Edit).

: Address to which the e-mail will be sent.

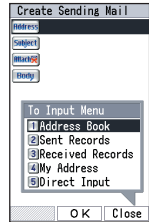

You can send an e-mail up to five addressees at a time.





3 Press  (Address Book), use  to select an addressee, and then press  (Select).

You can select an addressee from sending records, receiving records, or My Address, or you can enter an address.



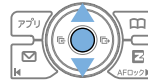



4 Use  to select the e-mail address you want to enter, and then press  (OK).

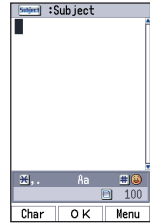
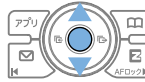

5 Use  to select **Subject**, and then press  (Edit).

Subject: Subject of the e-mail message.



6 Enter the subject, and then press  (OK). Use  to select **Body**, and then press  (Edit).

Body: Body of the e-mail message.

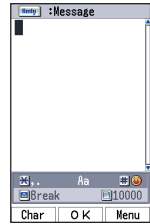

7 Enter the body text, and then press  (OK).

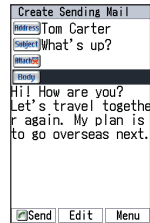

8 Press **アプリ** (Send) or **ベア**.

The message "Sent." appears on the display after the e-mail message is sent.



Reading Received E-mail Messages



When you receive an e-mail

The message “ E-Mail” and appear on the standby screen.

Received e-mail icon



- 1** Select “ E-Mail,” and then press (OK).



- 2** Press (OK).

: Indicates an unread message.
 : Indicates an already read message.

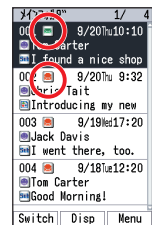
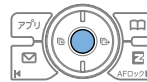

- 3** Use to select the unread e-mail you want to view, and then press (Disp).

The received e-mail message appears.
 If all of the message cannot be displayed, press to scroll.

Use and to scroll between messages.
 Press to return to the e-mail message list.

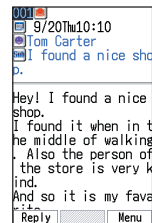

Reading an E-mail Message with an Attached Photo



1 Use to select the e-mail message, and then press (Disp).

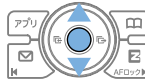

2 Use to select the attached data and then press (Select).

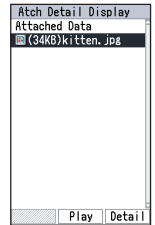
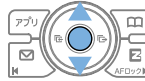

3 Use to select a file name, and then press (Play).

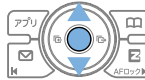

Info

- Depending on the size of the attached data, it may not come in at the same time as the mail message. If this happens, use in step 3 to select the file name, press (Rcv), and then press (Play).
- The sending and receiving operations may take longer when a mail message has data attached.
- Certain signal conditions may also cause e-mail sending and receiving to take longer than normal.

Replying to a Received E-mail Message



To reply to an e-mail message, perform steps 1 through 3 under “Reading Received E-mail Messages” (page 54), and then perform the following steps.

1 Press **アプリ** (Reply).

Subject is prefixed with “Re:,” and the body text of the e-mail is quoted.

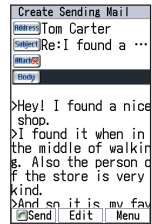
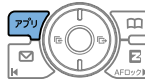

2 Press **編集** (Edit), and then enter the body text.

For the remainder of this procedure
→ Perform the procedure starting from step 7 under “Creating and Sending E-mail Messages” (page 52).



Avoiding Spam

It is recommended that you use our mail filter function to block spam.

You can use “supportive settings” to easily configure mail filter settings by answering questions that appear on the display.

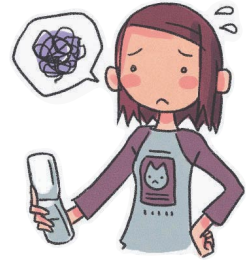

■ Configuring Mail Filter Settings

Example: To access the “サポート設定” (Supportive settings)

- ① While the standby screen is displayed, press .
- ② Press (E-Mail Setup) → (Mail Filter) → (Yes).
- ③ Use to select “次へ” (Next) and then press (Select).
- ④ Enter your Security Code, press (OK).
 - Use to select “送信” (Send) and then press (Select).
- ⑤ Use to select the item and then press (Select).

Next, follow the instructions that appear on the display.

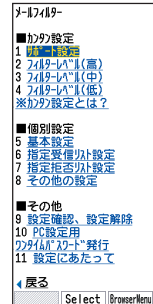

■ “カンタン設定” (Simple Settings)

“サポート設定” (Supportive settings)	You can choose filtering options by answering our questions. It is recommendable for those who want to check the filtering conditions one by one.
“フィルターレベル(高)” (Filter level (Strict))	You can block all the mails from PC. It is recommendable for those who use only cellphones to send e-mails.
“フィルターレベル(中)” (Filter level (Medium))	You can block the e-mails from specified addresses in addition to the e-mails containing “未承諾広告※” (unsolicited advertisement) in their titles and “なりすましメール” (spoof e-mail). It is recommendable for those who are bothered by specified spam senders.
“フィルターレベル(低)” (Filter level (Normal))	You can block the e-mails containing “未承諾広告※” (unsolicited advertisement) in their titles, and “なりすましメール” (spoof e-mail). It is recommendable for all e-mail users.

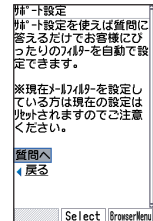

Info

You can prevent spam by changing your e-mail address. See “Changing Your E-mail Address” (page 27) for information about how to change your e-mail address.

Creating and Sending C-mail Messages

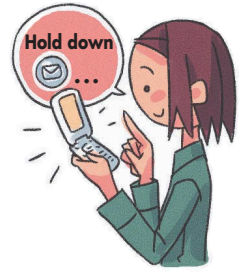

1 While the standby screen is displayed, hold down for about one second, and then press (Create New).

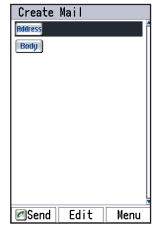

2 Select , and then press (Edit).

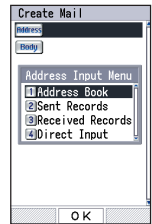
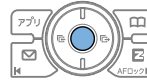

3 Press , use to select an addressee, and then press (Select).

You can also select a phone number from sending records or receiving records, or you can enter an address.



4 Use to select the phone number you want to enter, and then press (OK).

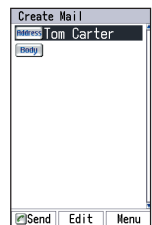
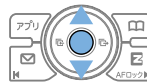

- 5** Use to select **Body**, and then press (Edit). Enter the body text, and then press (OK).

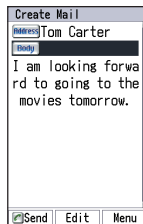

- 6** Press (Send) or (Back).

When the C-mail reaches the other party, the message “Completed.” appears, and the message is stored in your sending records.



Reading Received C-mail Messages

Mail

When you receive a C-mail

The message “ C-Mail” and appear on the standby screen.

Received C-mail icon



- 1** Select “ C-Mail,” and then press (OK).

: Indicates an unread message.

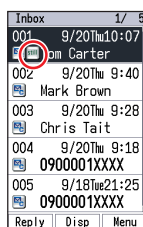

- 2** Use to select the unread C-mail you want to view, and then press (Disp).

The received C-mail message appears. Use and to scroll between messages. Press to return to the C-mail message list.

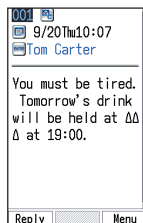

Camera

The W53CA has a 5.1-megapixel camera with approximately 5.15 million effective pixels and powerful functions to support various types of digital imaging. You can attach the photos that you record to e-mail messages.

Using the Camera

Shooting a Photo (page 62) Shooting Photos in Viewfinder Position (page 63)

1

Use your images for W53CA functions!

You can use photos you shot for the standby screen, for the image that appears while the ring tone is sounding, and in your address book.

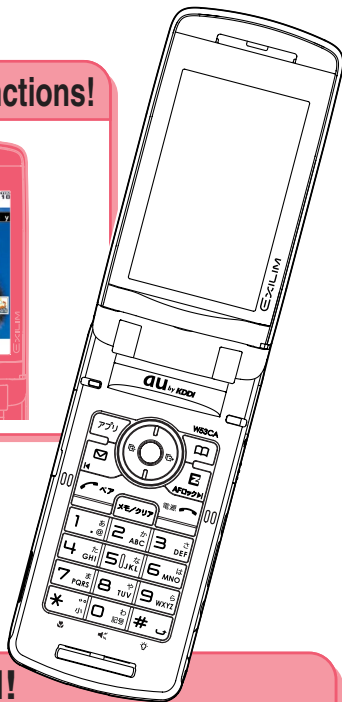

2

Send images by e-mail!

Within 500KB, you can send a photo as an e-mail attachment.

- ※ Certain signal conditions may cause e-mail sending and receiving to take longer than normal.

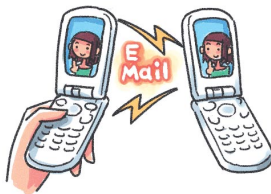

Tips for Better Photos

Shooting with W53CA open

Do not cover the lens or optical sensor with your hands. Hold the camera securely with both hands. Use your thumb to press  (Shutter) to release the shutter.

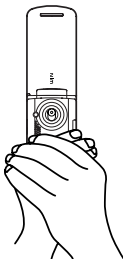

Shooting in the Viewfinder position

Do not cover the lens or optical sensor with your hands. Hold the camera securely with both hands. Use the index finger of your right hand to press  to release the shutter.

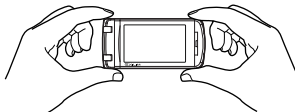

Tips for Avoiding Hand Movement

- Remain steady by keeping your arms lightly against your sides and standing with your feet about shoulder width apart. Having your arms away from your side or extended in front of you can cause blurred images.
- When you press the shutter button, remain still until your shutter tone finishes sounding. This is especially important when shooting where lighting is dim.
- A self-timer is also provided for shooting photos. With the self-timer, you do not need to press the shutter button to shoot a photo, so there is less chance of a blurred image caused by accidental movement of the phone.

Auto focus

W53CA has built-in auto focus function. You can shot photos with the subject properly focused simply by pressing the shutter key.

Photo Sizes

The following shows the sizes of the photos that can be recorded with your W53CA.

Photo Sizes	Where to Save
Phone: 120×160	"Photo Folder" in W53CA's Data Folder
Wallpaper: 240×320	
WideWallpaper: 240×400	
VGAWallpaper: 640×480	"Digicam Fol" folder in microSD™ memory card
WVGAWallpaper: 800×480	
1M: 1280×960	
2M: 1600×1200	
3M: 2048×1536	
4M(Wide): 2560×1536	
5M: 2560×1920	



※ "Normal Shot" is selected as the photo mode and "VGAWallpaper" as the photo size when you purchase your phone.

※ The photo size is the same as "Wallpaper" when "Coupling Shot," "Updown Shot" or "WallPprSerial" is selected as the photo mode.

※ Photos are stored in the phone's Data Folder regardless of photo size whenever there is no microSD™ memory card loaded in the phone.

Shooting a Photo



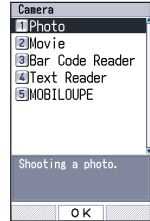

- 1** While the standby screen is displayed, press , use  to select “Camera,” and then press  (OK).



- 2** Press  (Photo), and then point the lens at the subject.



- 3** Press  (Shutter).

The phone emits a shutter sound. Note that the phone emits the shutter sound even if it is in Manner Mode. You can also press  /  in place of .

Check the subject through the monitor screen (within the area indicated as , and release the shutter.

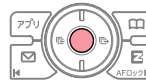

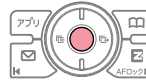

- 4** Press  (Save).

The display shows the message “Saved to data folder (Phone).” and then returns to the photo monitor screen. Photos you shoot are saved to the “Photo Folder,” which is in the Data Folder.



Info

- When shot mistakenly
If the photo is not what you want to take, press  /  in step 4. Next, repeat step 3 to redo.
- Loading a microSD™ memory card and shooting with the initial photo size setting (“VGAWallpaper”) will cause the photos to be stored in the microSD™ memory card’s “Digicam Fol” folder.

Shooting Photos in Viewfinder Position

The phone's Viewfinder position provides all the feel of shooting with a digital camera.



1 While the standby screen is displayed, change to the Viewfinder position.

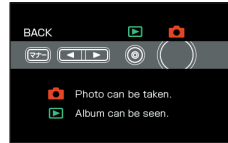

For details about changing to the Viewfinder position, see “Viewfinder Position and Self-portrait Position” (page 22). Changing to the Viewfinder position causes the Direct Camera Menu (page 23) to appear for about 30 seconds.

2 Press and point the lens at the subject.

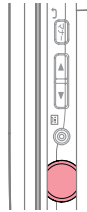

3 Press (Shot).

Check the subject through the monitor screen (within the area indicated as), and release the shutter. First, half-press (Focus lock is enabled). Then, without releasing your fingers off , full-press the key and shutter releases.

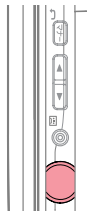



Display	Side key operation	Display	Side key operation
Shot		Menu	
Zoom		End	

4

Press (Save).

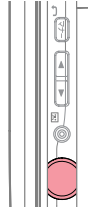
The display shows the message “Saved to data folder (Phone).” and then returns to the photo monitor screen. Photo you shoot are saved to the “Photo Folder,” which is in the Data Folder.



If the photo is not what you want to take, press . Next, repeat step 3 to redo.

Info

- ◎ You can also start photo by holding down  for about one second while the standby screen is displayed in the Viewfinder position.
- ◎ You can perform the same camera operations regardless of whether you start photo before or after you change to the Viewfinder position.

Viewing Photos



1 While the standby screen is displayed, press **OK**, use **Left** to select “Data Folder,” and then press **OK** (OK).

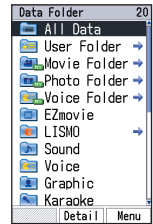

2 Use **Down** to select “Photo Folder,” and then press **OK** (Detail).

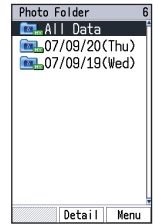
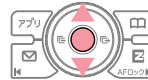

Selecting “All Data” displays a list of all photos in the “Photo Folder.”

3 Use **Down** to select the dated folder, and then press **OK** (Detail).



A list of all photos that were shot on that day are displayed.

4 Use **Left** to select the photo you want to view, and then press **OK** (Disp).



Info

When displaying images shot with the W53CA, some image sizes can result in a coarse image appearing first. After that, the normal image will appear.

Attaching a Photo to an E-mail Message

Perform the procedure from step 1 to 3 under “Shooting a Photo” (page 62), and then perform the following steps.

1 Press **アプリ** (E-Mail), and then press **1** **あ** (Attach).

Photos you shoot are stored in the “Photo Folder” in the Data Folder.

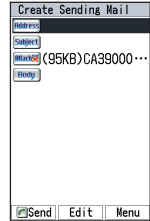

2 Perform the procedure starting from step 2 under “Creating and Sending E-mail Messages” (page 52) to create an e-mail message.

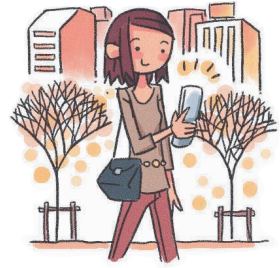

Using EZweb

To use EZweb, you need to subscribe to an EZweb beforehand. If you did not subscribe when you purchased your phone, contact your nearest au shop or the au Customer Service Center.

In addition to an EZweb subscription, you also need to perform an initialization procedure before you can use EZweb. If you have not performed initialization yet, refer to “Initializing E-mail and EZweb” (page 25).



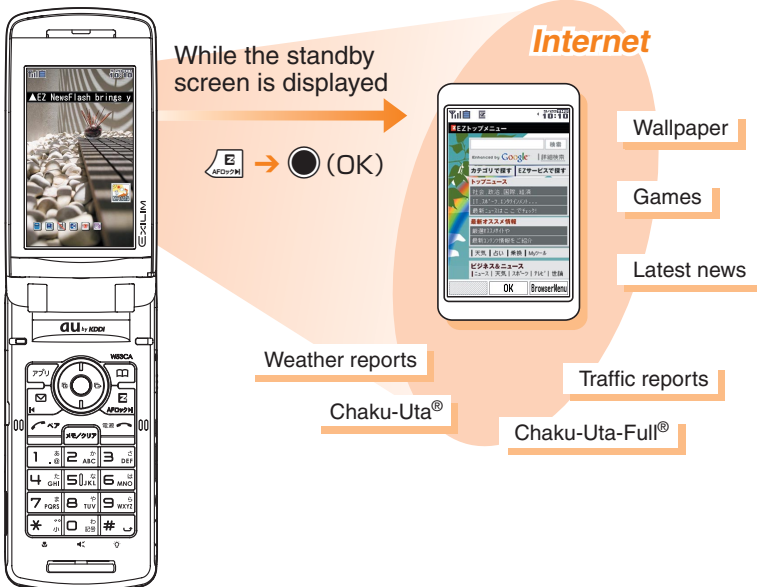

EZweb is an information service for simple Internet access from your phone. EZweb lets you search for information on the Web, and provides you with access to Chaku-Uta®, the latest news, and other web-based contents (information sites).

※ You will be charged for packet communication fees in accordance with the amount of data involved when you connect to EZweb, regardless of how long you are connected.



Displaying the EZ Top Menu

1

While the standby screen is displayed, press , use   to select “EZweb,” and then press  (Top Menu).

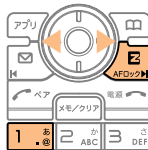

1	キーワード検索機能 (Search by keyword) Provides information search function by keywords
2	カテゴリで探す (Search by category) Searches for a site by category
3	EZサービスで探す (Search by useful EZ services) Introduces useful, amusing and recommended services special to EZweb
4	トップニュース (Top News) Provides the automatically-updated latest top news
5	最新オススメ情報 (What's Hot) Introduces various EZweb features and content information
6	デイリーツール (Daily Tools) Provides daily information about weather, fortunetelling, etc., along with handy train transfers
7	ビジネス&ニュース (Business & News) Provides the latest information such as news, weather, and other information beneficial for business
8	エリア (Area) Provides local information about train transfers, map searches, etc.
9	ショッピング&オークション (Shopping & Auctions) Provides information about where you can purchase goods with your cellphone, and information about how to use net auctions to buy and sell goods
10	ライブ (Daily life) Provides useful information for daily life
11	ホビー&カルチャー (Hobbies & Culture) Provides the latest information about games, music, e-books, and information about hobby and entertainment trends
12	コミュニティ (Community) Provides the useful, amusing information that make you feel like using such as SNS, blog
13	au My Page Provides a place where you can configure information and tools to suit your needs, and to store large volumes of data
14	au style Introduces au-recommended information and sites
15	とくする情報 (Valuable Information) Provides gifts and useful information exclusively for EZweb service subscribers for free
16	auお客さまサポート (au Customer Support) Provides phone bills, procedures, au information, and au on-line manuals
17	災害用伝言板 (Disaster Message Board) Registers/checks the safety information in disasters
18	ENGLISH Introduces English sites

8 CAUTION

- ◎ The layout and contents of the EZweb screens shown here are for example purposes only.
- ◎ Some sites may charge you for the content in addition to call charges.

Bookmarking Sites You Frequently Access



1 Display favorite sites you want to bookmark, and press  (BrowserMenu).

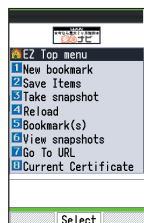
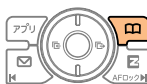



2 Press  (New bookmark).

※ You may not be able to bookmark some sites.

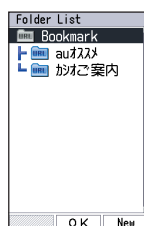

3 Press  (Reg).



4 Use  to select a folder, and then press  (OK).

The message “Registered.” appears when completed.



Info



You can have up to 100 sites in the Bookmark(s).

Viewing a Bookmarked Site



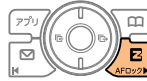

1 While the standby screen is displayed, press .



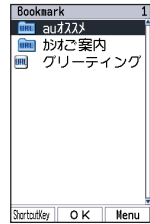

2 Use  to select “EZweb,” and then press  (Bookmark(s)).







3 Use  to select a site or folder, and then press  (OK).





If you selected a folder, use  to select a site, and then press  (OK).



Checking Charges

You can check call and transmission charges.

1 While the standby screen is displayed, press    .

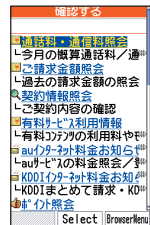
When the EZweb connection confirmation screen appears, press  .



2 Use  to select the item you want to check, and then press  (Select).



Downloading Chaku-Uta®/Chaku-Uta-Full®

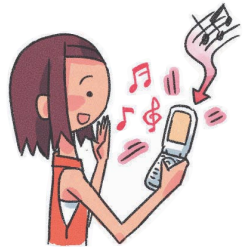

To download a Chaku-Uta®/Chaku-Uta-Full®, perform step 1 under “Displaying the EZ Top Menu” (page 68), and then perform the following steps.

- 1** Use to select “カテゴリで探す” (Search by Category), and then press (OK).



- 2** Use to select “着うたフル・ビデオクリップ” (Chaku-Uta-Full® and Video Clip) or “着うた” (Chaku-Uta®), and then press (Select).

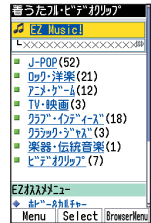

- 3** Select the content (desired information site), and download it.

In order to use fee-based contents, you need to enter your EZ Password or Premium EZ Password.

Initial Value: Any 4-digit number you entered on your subscription contract.

Input the required password according to the instructions that appear on the display. To download information, follow the instructions that appear on the display. Downloaded data is stored in the Data Folder.

8 CAUTION

In addition to call charges, you will be charged according to the pricing policy of each site to download Chaku-Uta®/Chaku-Uta-Full® and other contents from a fee-based site.

Info

- ◎ Perform the same procedure to download wallpaper and use it for the standby screen background.
- ◎ You can also access an information site where you can download Chaku-Uta-Full® by pressing while the standby screen is displayed, using to select “au Music,” and then pressing (Jump to EZ Music!).

EZ Navi Features

EZ Navi uses global positioning system (GPS) information to provide you with useful information.



Standby screen

Press .

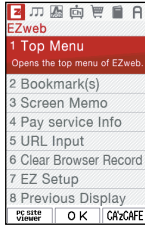

EZweb menu

Use to select "EZnavi."



EZ Navi menu

Checking your route: Passenger Seat Navi

Passenger Seat Navi makes it possible for the passenger (non-driver) in a motor vehicle to check route information to a destination using both voice and map guides.



When you check where your child is: Security Navi

"Security Navi" application is composed of following three functions:
 "Auto Position Search" (paid), "Position Search Mail" (free), "Area Message" (free).

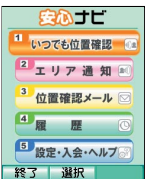

These functions enable you to check the location of an au cellphone supporting "Security Navi" and receive an alert mail which is sent to a particular au phone whenever another phone enters (or is inside of) or exits (or is outside of) a preset area by operating W53CA.

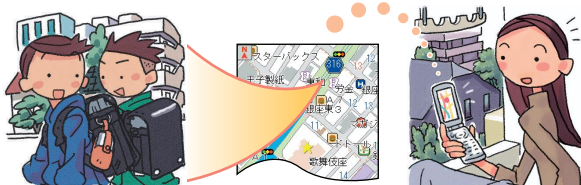

EZ Navi Walk

A menu of useful options you can use while you are out.



ナビをする* (Navigation)	Searchable source of a route guidance (voice navigation) to your destination, shops, and facilities
地図を見る (free)* (View Map)	You can view a map of your current location or any other location.
乗換検索する (free ^(*)) (Search Connection)	Searchable source of train transfer and timetable information
道路情報を見る (View Traffic Info)	Check real-time traffic information on the major roads all over Japan.
もっとナビウォーク (EZ Navi Walk)	Provides explanations about each setting or search on PC.
インフォメーション (Information)	You can register for memberships or make inquiries.

The star symbol shows that you can use your voice to enter search terms. This is called "voice input" function.

※1 You are charged a fee for some services.

View My Position



Your initial location is indicated by ★. Changes in your location are indicated in real time by 人.

3D Navi



The display is switched to the 3D image at the guidance point or a point near the destination.

Navigation engine by NAVITIME JAPAN
Map: Shobunsha Publications, Inc./ Sumitomo Electric Industries, Ltd.
3D data: ZENRIN CO., LTD./GEO Technical Laboratory Co., Ltd.
Z06A-No.2137

Evacuate Navi



Evacuate Area Map



Route Home Map

Map: Shobunsha Publications, Inc./
Preparation: Asia Air Survey Co., Ltd.

You can use the map data stored in the Data Folder of the W53CA to locate the nearest refuge shelter or to determine the direction to your home (Evacuate Area Map). You can also access the Evacuate Navi EZweb site to download contents, including the recommended route between two points, such as from your place of work to your home (Office to Home), a Route Home Map, etc.

- ※ In order to have it indicate your direction home, you will have to pre-register the GPS information for your home in the W53CA address book.
- ※ Some contents may require payment.

Info

- All display information is intended for reference purposes only. Be sure to follow all instructions issued by police, fire department personnel, government officials, etc.
- Due to GPS satellite conditions and other factors, it may take some time for Evacuate Navi to indicate your current location.
- The display layout and contents shown here are for example purposes only.
- Depending on the number of records stored in your address book, it may take some time for map viewer to start up.
- You will be charged for packet communication fees when you use an EZ Navi service. Some services also have separate content charges.

Simple Mode

Simple Mode lets you limit operations to the telephone function, address book, camera, e-mail, C-mail, EZweb, and other frequently used functions, which simplifies operations.



Entering Simple Mode

- 1 While the standby screen is displayed, press **OK**, use **Left Arrow** to select “Settings,” and then press **OK**.

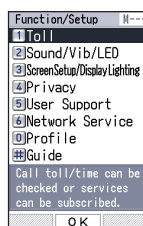

- 2 Press **5** (User Support) and **4** (Mode Setup).

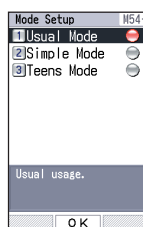

- 3 Press **2** (Simple Mode).





Info

- The lock No. is required when changing from Teens Mode to Simple Mode.
- When you enter Simple Mode, settings configured in Usual Mode are automatically changed to those configured in Simple Mode.

Exiting Simple Mode

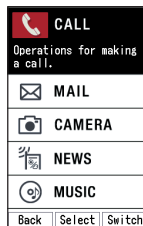
1 While the standby screen is displayed, press .



2 Use  to select "SETTINGS," and then press  (Select).

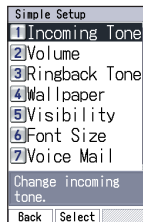

3 Press  (SimpleModeOFF).

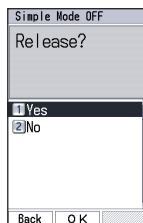

4 Press  (Yes).

This returns to Usual Mode.



Using the Simple Mode Main Menu

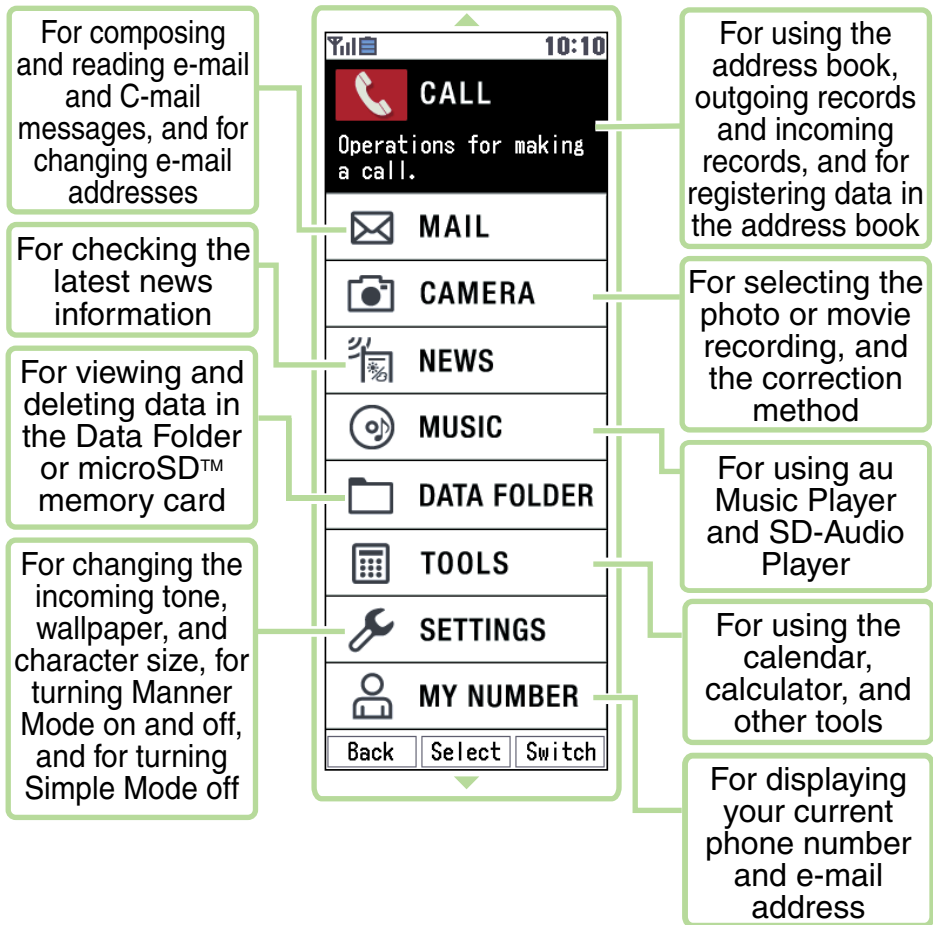

Info

Simple Mode has its own main menu.

You can switch between the two available Simple Mode main menu styles by pressing  (Switch).

Adding Data to the Address Book in Simple Mode



1 While the standby screen is displayed, press , press (Register), and then press (Fix).



2 Enter the name, and then press (OK).

To input text
→ “Inputting Characters” (page 39)



3 Check the reading of the name you inputted, press (OK), and then press (Input by Myself).

You can also select data in incoming records or outgoing records.
To go without saving the telephone number, press (Not Input) and perform step 5.



4 Enter the phone number, and then press (OK).

When entering the number of a standard phone, be sure to start with the area code.



5 Press (Input by Myself).

You can also select data in sending records or receiving records.
To go without saving e-mail address, press  (Not Input) and perform step 7.

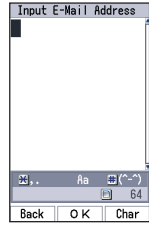

6 Enter the e-mail address, and then press (OK).

To input an e-mail address
→ “Inputting an E-mail Address”
(page 40)



7 Press (Not Register).

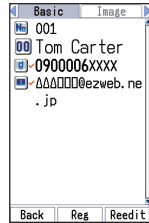

Pressing  (OK) displays a confirmation screen.



8 Press (Reg).





Info

- In Simple Mode, you can only input “Name,” “Reading,” “Phone Number1,” “E-Mail Add1,” and “Image” data into an address book record.
- You can press  (Register) in step 7 to select a photo in the Data Folder and assign it to the address book record.
- Pressing  (Reedit) in step 8, and then pressing  (Change) returns to step 2 from which you can edit the contents of the record.



Using the Address Book in Simple Mode



Example: To view a record in address book

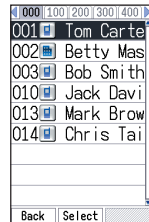



- 1 While the standby screen is displayed, press , and then press  (Look).



- 2 Use  to select the address book record you want to view, and then press  (Select).



- 3 Press  (Read Data).

The address book record appears. Use  to select the phone number, and press  (Call). You can make a phone call. Use  to select the e-mail address, and press  (E-Mail). You can create an e-mail message.

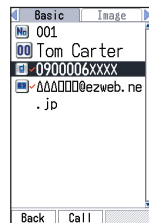

By using the address book, you can make a phone call and send an e-mail. And you can edit and delete an address book record and send it via infrared communication.

Creating and Sending E-mail Messages in Simple Mode

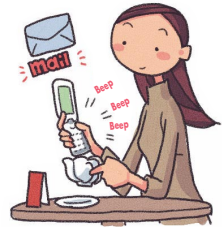

1 While the standby screen is displayed, press .

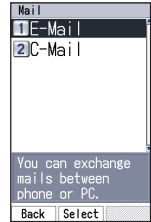

2 Press  (E-Mail).



3 Press  (Create Mail).

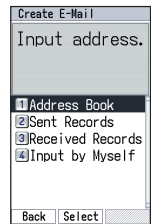

4 Press  (Address Book).

You can select an addresses from sending/receiving records, or you can manually enter an address.



5 Use to select an addressee, and then press (Select).

When you have already registered two or more e-mail addresses in the address book (in Usual Mode/Teens Mode), setting to Simple Mode displays only the e-mail address you usually use.



6 Press (Select).

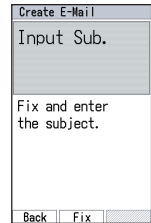

7 Press (Fix).



8 Enter the subject, and then press (OK).

To input text
→ "Inputting Characters" (page 39)

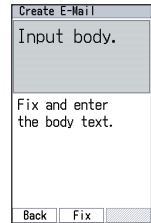

9 Press (Fix).



10 Enter the body text, and then press ● (OK).

To input text
→ “Inputting Characters” (page 39)

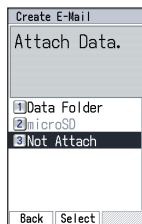

11 Press ☰ DEF (Not Attach).

Pressing ● (OK) displays a confirmation screen.

In case of attaching some data with e-mail, operate the followings.

 (Data Folder):

You can select a photo saved in the Data Folder and attach it to the e-mail message.

 (microSD):

You can select a photo saved in the microSD™ memory card and attach it to the e-mail message.

In Simple Mode, an e-mail message can have only one attachment.

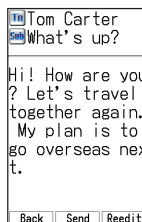

12 After checking the content of the e-mail, press ● (Send).

The message “E-Mail is sent.” appears on the display after the e-mail message is sent.



Info

Pressing  (Reedit) instead of ● (Send) in step 12 returns to step 4, from which you can edit the contents of the e-mail message.

Shooting a Photo in Simple Mode



1 While the standby screen is displayed, press **●**, use **⬆** to select “CAMERA,” and then press **●** (Select).

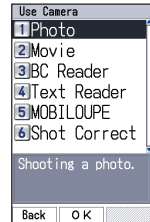

2 Press **1** (Photo), and then press **1** (Photo1).

Photo1	Wallpaper
Photo2	WVGA Wallpaper
Photo3	5M

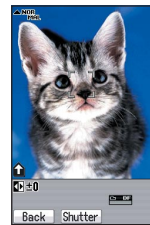

3 Point the lens at the subject, and then press **●** (Shutter).

The phone will emit a shutter sound.
You can also press **○/⊙** in place of **●**.

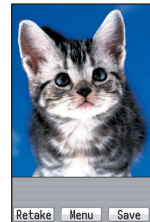

4 Press **☰** (Save).





Info

Pressing **●** (Menu) in step 4, and then pressing **2** (Send Mail) will display a screen for composing an e-mail message with attached photo.
To create an e-mail message

→ Perform the procedure starting from step 4 under “Creating and Sending E-mail Messages in Simple Mode” (page 80).

Viewing Photos in Simple Mode



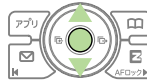

- 1** While the standby screen is displayed, press , use  to select “DATA FOLDER,” and then press  (Select).



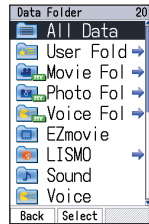

- 2** Press  (Data Folder).



- 3** Use  to select “Photo Folder,” and then press  (Select).

Selecting “All Data” displays a list of all photos in the Photo Folder.





- 4** Use  to select the dated folder, and then press  (Select).

A list of all photos that were shot on that day are displayed.



5

Use  to select the photo you want to view, and then press  (Menu).



6

Press  (Play).

The photo appears.



 (Delete): Deletes data.

 (Attach E-Mail):

Displays a screen for composing an e-mail message with an attachment.

To create an e-mail message

→ Perform the procedure starting from step 4 under “Creating and Sending E-mail Messages in Simple Mode” (page 80).

 (MoveTo microSD): Moves the data to microSD™ memory card.

 (Send via Ir): Sends your data via infrared.

Info

When displaying images shot with the W53CA, some image sizes can result in a coarse image appearing first. After that, the normal image will appear.

Teens Mode

Teens Mode can be used to block spam, and to block inadvertent access to phone numbers and URLs included inside mail messages. Teens Mode can also be used to restrict call time and the number of sending mail.



Using Teens Mode

■ **Teens Mode can be used to restrict mail reception and display contents.**

When the sender is a Pair Partner	Receipt is allowed.
When the sender is included in the address book	Receipt is allowed. However, the phone numbers, e-mail addresses or URLs contained in the body of the mail message can not be used.
When the sender is not either of the above	E-mail: Only the sender's name and subject are received. Body text and attached data are not received. C-mail: Not received.

■ **Turning on “Teens Restrict” and Teens Mode makes it possible to restrict call time and the number of sending mail.**



● Making a Call

To someone who is a Pair Partner	No restriction
To someone who is not a Pair Partner	Call time is restricted. Further calling is not possible if the call time exceeds the “Teens Restrict” setting.



● Sending a Mail

To someone who is a Pair Partner	No restriction
To someone who is not a Pair Partner	The number of sendings is restricted. Further mailing is not possible if the number of sendings exceeds the “Teens Restrict” setting.

Turning on Teens Mode

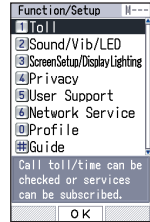
1 While the standby screen is displayed, press , use  to select “Settings,” and then press .



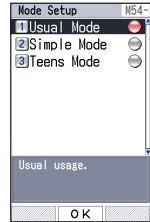

2 Press  (User Support), and then  (Mode Setup).

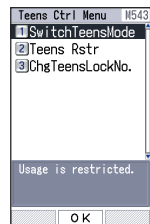

3 Press  (Teens Mode).



4 Press  (SwitchTeensMode), and enter the lock No., and press .



Info

The lock No. is required when changing from Teens Mode to Usual Mode or Simple Mode.

Other Functions

Security Setup Features

With Security Setup, you can make a phone call to preregistered numbers or use high-volume buzzer just holding down  for about one second.

Safety Buzzer

You can use W53CA as high-volume emergency buzzer by holding down  for at least one second while the standby screen is displayed.



■ To turn on Safety Buzzer

While the standby screen is displayed, press     , input the lock No., and then press  (OK).

■ To stop Safety Buzzer

To stop Safety Buzzer, input the lock No., and then press  (OK).

※ You cannot turn off W53CA or perform any other operation while the Safety Buzzer is sounding. The Safety Buzzer will continue to sound until you input the lock No. or the battery fully discharges.

Hot Dial

With Hot Dial, holding down  for about one second will dial a preset phone number.

■ To turn on Hot Dial

While the standby screen is displayed, press     , input the lock No., and then press  (OK).

Next, input the phone number you want to preset, and then press  (Reg).

Info

- ◎ The Safety Buzzer will sound through the W53CA's speaker while the Casio round-type earphone jack conversion adapter 03 and the SONY MDR-E0931, flat-type switched earphone microphone (option), or flat-type stereo earphones microphone (option) is connected.
- ◎ Even when Manner Mode is on, Safety Buzzer sounds.

Extension Mode

Using the Extension Mode, W53CA automatically shuts down the radio wave after issuing the Low Battery Alert. This is quite a useful function that you can still check outgoing/incoming records, content of e-mail, address book, schedule and so on when necessary. In this case, you can only use the functions which needs no radio wave.

To turn on Extension Mode

While the standby screen is displayed, press     .

Display example when you switch to Extension Mode

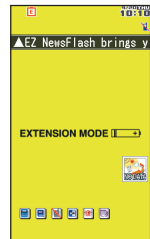

In addition to the functions covered in this Basic Manual, your W53CA also has the following features.

Global Expert

W53CA supports Global Expert based on au IC-Card.

Global Expert is an international roaming service for the customers to use the phone replacing its au IC-Card with GSM cellphone for overseas use. No special application procedure or daily/monthly fee are needed, and the call charge is added up to domestic call, so the pay procedure is simple.

au Music

You can use au Music Player to enjoy a Chaku-Uta-Full® or your favorite CD tracks. Also, you can download a Chaku-Uta-Full® or purchase CD tracks by accessing "EZ Music!"

PC Document Viewer

Display Microsoft® Word, Microsoft® Excel, Microsoft® PowerPoint®, PDF, HTML, and mHTML data created on a computer. Features include full-screen display, zoomed display, portrait or landscape orientation, resize to fit, and more.

Barcode Reader & Maker

You can use the camera to read QR codes and barcodes. Also, you can create your own barcodes directly from your address book entries.

au My Page

You can upload and backup various data in your W53CA (in Address Book, E-mail, Data Folder, Bookmarks, etc.) to au My Page on server to manage/check them.

Touch Message

Send and receive messages, Address Book data, Schedule data and Data Folder data, and other data with another au cellphone that supports EZ FeliCa.

Infrared Communication

You can exchange the data saved in your Address Book, Schedule, Bookmarks, or Data Folder between au cellphones supporting infrared communication.

EZ Apps (BREW®)

Enjoy downloaded games and other software.

















Wide VGA Size (800 × 480) High-resolution Display

Standby screen wallpaper, images, EZ Navi Walk maps, PC Site Viewer website screens, and more are displayed with fine detail and resolution.

EZ News Flash

You can check latest news report on your standby screen. With this total new "information delivery service," you can select news flash telop or news flash window to browse various news information.

Troubleshooting

Symptom	What to check	What to do	Page
The phone does not turn on. 	Is the battery pack installed correctly?	Correctly install the battery pack.	—
	Is the battery pack charged?	Charge the battery pack. ※	P.12
	Are you holding down  for at least 1.5 seconds?	Hold down  for at least 1.5 seconds to turn on the phone.	P.14
I can't make calls. 	Is  (Out of Range) on the display?	Wait until you are in a location where  is not displayed before trying to make a call.	P.14
	Are you including the area code?	When making a call to a standard phone, you need to input the area code, and then the phone number.	P.29
	Is the phone turned on?	Hold down  for at least 1.5 seconds to turn on the phone.	P.14
	Did you press  ?	After inputting the phone number, press  to dial it.	P.29
	Is Emission OFF Mode turned on?	Turn off Emission OFF Mode.	—
I can't receive calls.	Is  (Out of Range) on the display?	Move to a location where  is not on the display.	P.14
	Is the phone turned on?	Hold down  for at least 1.5 seconds to turn on the phone.	P.14
	Is Emission OFF Mode turned on?	Turn off Emission OFF Mode.	—
Nothing happens when I press the keys.	Is the phone turned on?	Hold down  for at least 1.5 seconds to turn on the phone.	P.14
The phone emits a warning tone, and then turns off.	Is battery pack power low?	Charge the battery pack.	P.12
The phone answers calls automatically.	Is Easy Voice Memo turned on?	Hold down  for about one second to turn off Easy Voice Memo.	P.37
	Is Drive Mode turned on?	Hold down  for about one second to turn off Drive Mode.	P.4
I can't hear the caller.	Is the earpiece volume level too low?	During a call, press  to increase earpiece volume.	P.36
	Is the earpiece covered with your ear?	Make sure to place the earpiece to the center of your ear.	—

※ The message “hang on a sec?” will appear when you turn on power while the battery is low. After a few seconds, the display will go blank.

For more detailed information, visit one for the following CASIO websites.

- On your W53CA phone, go to <http://ez.casio.jp/faq/> (CASIO Cellphone FAQ). (Japanese only)
- On your computer, go to <http://k-tai.casio.jp/faq/> (CASIO Cellphone FAQ). (Japanese only)

If you lose your W53CA

Configuring “Lock by Incoming” settings for Remote Ctrl Lock makes it possible to perform a remote operation that activates Auto Lock and FeliCa lock to lock the W53CA. This helps to avoid unauthorized use of your phone and its features.

■ Configuring Operating Environment Settings for Lock by Incoming

Repeatedly calling the W53CA from a pre-registered telephone number a specified number of times within a specified amount of time will activate Auto Lock and FeliCa Lock.

- 1 While the standby screen is displayed, press , input the lock No., and then press (OK).

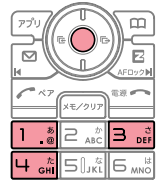

- 2 Press (Lock by Incoming) and then press (Caller ID List).



- 3 Use to select a registration number, press (Edit), input the phone number, and then press (Reg).



You can also press (Menu) before inputting a phone number, and select the number from the address book, outgoing records, or incoming records, or you can specify a pay phone. You can register up to three different phone numbers.

Press twice and advance to the next step.

- 4 Press (ON/OFF Setup), and then press (ON).



- 5 Press (Specified Time), input the period you want to specify, and then press (OK).

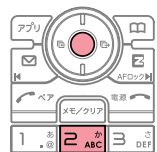

You can set the time period (the time intervals from the first call to the last call you should make to activate Remote Ctrl Lock).

You can set the time period between 1 to 10 minutes.

6

Press **☰ DEF** (Num of Incoming), input the number of calls you want to specify, and then press **●** (OK).

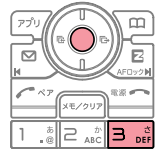

You can set how many times you should repeat making a call to activate Remote Ctrl Lock.
You can set it from 3 to 10 calls.

■ Using Remote Operation to Lock the W53CA with Auto Lock and FeliCa Lock

1

After using the procedure under “Configuring Operating Environment Settings for Lock by Incoming” (page 92) to register the calling phone number, place the specified number of consecutive calls from the registered phone number to the W53CA within the specified amount of time.

You will hear the announcement “遠隔ロックを設定しました” (Remote Ctrl Lock activated), and the W53CA will be locked using Auto Lock and FeliCa Lock. Activation of Remote Ctrl Lock will cause your W53CA to turn off and then back on again automatically.

⚠ CAUTION

- ◎ Remote Ctrl Lock cannot be activated if the W53CA is not turned on or if it is outside its service area, or when “Emission OFF” is selected for “Emission OFF Mode (M57).” Also, you may not be able to activate Remote Ctrl Lock while the W53CA is in an area when the signal is weak.
- ◎ The initial default setting for the “Rel Phone Lock” of “Remote Ctrl Lock (M413)” is “Invalid.” When “Invalid” is selected, the unlock screen is not displayed while Remote Ctrl Lock is activated, and Remote Ctrl Lock cannot be unlocked using a W53CA operation. When “Valid” is selected, pressing any key while Remote Ctrl Lock is activated displays an unlock screen. Entering the proper lock number will deactivate Remote Ctrl Lock and unlock the phone.
- ◎ The initial default setting for the “Erase Data” of “Remote Ctrl Lock (M413)” is “OFF.” When “ON” is selected, activating Remote Ctrl Lock will perform “Memory Reset (M462)” and delete all data in the phone memory.

■ Using the Security Lock Service to Activate Remote Ctrl Lock

With the Security Lock Service, you can activate Auto Lock and FeliCa Lock remotely by placing a call to an au Customer Service Center or with your computer even if your phone is not configured for Lock by Incoming. The Security Lock Service is free.

Using the Security Lock Service

● Calling an au Customer Service Center to Activate or Deactivate Remote Ctrl Lock

On an au phone, dial 113 (free).

From another type of cellphone or a standard phone, dial the following toll-free number: ☎ 0077-7-113 (free).

- This service is available 24 hours per day.
- Follow the instructions of the voice response menu.

● Using a Computer to Activate or Deactivate Remote Ctrl Lock

On the Internet, go to MyKDDI (<http://my.kddi.com/>) and log in, and then follow the instructions that appear on the screen.

※ Registration is required the first time you use this service. You can register even after you lose your phone.

Index

A

Address Book	43
Adding outgoing or incoming record data to the address book	46
Deleting	44
Dialing from the address book	47
Editing	45
Registering	43
Adjusting the earpiece volume	36
Adjusting the ring tone volume	35
Answering a call	31
au IC-Card	11

B

Battery level	14
Battery pack	10, 11

C

Caller ID	29
Camera	60
Shooting a photo	62
Shooting photos in Viewfinder position	63
Viewing photos	65
Casio round-type earphone jack conversion adaptor 03	10
Casio USB cable 01	10
Cellphone etiquette	1
Chaku-Uta®/Chaku-Uta-Full® , Downloading	71
Changing the ring tone	33
Charging the battery pack	12
Checking charges	70
C-mail	51
C-mail Safety Block	51
Creating and sending	58
Reading	59

D

Desktop holder	10, 12
Direct Camera Menu	23
Disaster Message Board Service	6
Display indicators	19
Display language	16
Drive Mode	4

E

Earpiece volume	36
Easy Voice Memo	37
Deleting	38
Playback	38
Turning on	37

E-mail	50
Avoiding spam	57
Changing your e-mail address	27
Creating and sending	52
Initializing e-mail	25
Looking up your e-mail address	26
Reading	54
Reading an e-mail message with an attached photo	55
Replying	56
Extension Mode	89
EZ Navi	72
EZ Navi Walk	73
EZweb	67
Bookmarking sites	69
Downloading Chaku-Uta®/ Chaku-Uta-Full®	71
EZ Password	71
EZ Top Menu	68
Viewing a bookmarked site	70

H

Hot Dial	88
-----------------------	----

I

Incoming records	32
Initial settings (e-mail and EZweb) ..	25
Initial values	14
Inputting characters	39
Inputting an e-mail address	40
Inputting pictographs	41
Inputting useful sentences	41
International call	30

K

Key functions	18
----------------------------	----

L

Looking up your phone number	26
---	----

M

Mail	50
C-mail	51
E-mail	50
Mail filter	5, 57
Main menu	20, 76
Making a call	29
Making an international call	30
Manner Mode	36
microSD™ memory card	11, 19
Missed call notification	31

N

Names of parts	11
-----------------------------	----

O

One-ring Calls	5, 32
Operation basics	18
Outgoing records	32

P

Pair Function	48
Making a phone call	49
Registering a Pair Partner	48
Sending mail	49
Phone call	29
Photo	60
Sending a photo by e-mail	66
Shooting a photo	62
Shooting photos in Viewfinder position	63
Viewing photos	65

R

Redialing (outgoing/incoming records) ...	32
Remote Ctrl Lock	92

S

Safety Buzzer	88
Security Code	15
Security Lock Service	94
Security Setup	88
Hot Dial	88
Safety Buzzer	88
Self-portrait position	22
Signal strength	14
Simple Mode	74
Adding data to the address book	77
Creating and sending e-mail messages	80
Entering Simple Mode	74
Exiting Simple Mode	75
Main menu	76
Shooting a photo	83
Using the address book	79
Viewing shot photos	84
Soft keys	21
SONY MDR-E0931	10
Spam	5, 57
Standby screen	14

T

Teens Mode	86
Troubleshooting	91
Turning on power	14

U

Unsolicited advertisements	5, 57
Using Menus	21

V

Vibrating	36
Viewfinder position	22, 24

For inquiries, call:
au Customer Service Center

From EZweb site:

How to access

EZ→Top Menu→auお客様サポート
(au Customer Support)
→お問い合わせ(Inquiries)



※Menu structure is subject to change without notice.

General Information, Rate Information

From regular phones:

 **0077-7-111**

(toll free)

From au cellphones:

157 area code not required

(toll free)

In case of loss, theft, or malfunction...

From regular phones:

 **0077-7-113**

(toll free)

From au cellphones:

113 area code not required

(toll free)

Pressing "zero" will connect you
to an operator, after calling "157"
on your au cellphone.



モバイル・リサイクル・ネットワーク

携帯電話・PHSのリサイクルにご協力を。
Cellphone and PHS operators collect and
recycle unused telephones, batteries and
battery chargers at stores bearing the ♻️
logo regardless of brand and
manufacturer to protect the environment
and reuse valuable resources.

Sales: KDDI Corporation
Okinawa Cellular Telephone Company
Manufactured by CASIO COMPUTER CO., LTD.

Read this to access to the
au On-Line Manual



MN6370YAA-1
July 2007, 1st Edition